

Characteristics / Ordering Code

Manatrol throttle check valves series FS allow the adjustment of the flow for a defined direction.

A 2 stage needle allows for very exact setting of smaller flow rates with the first 3 rotations of the adjustment knob. After 3 more rotations, the valve is completely open. The valve setting can be locked by a locking screw.

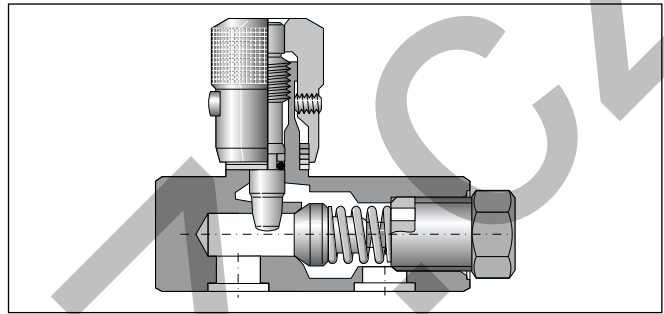
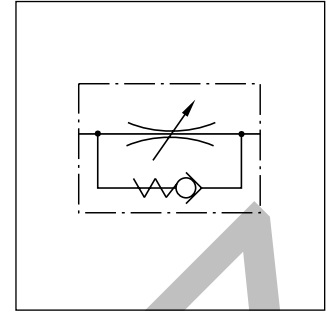
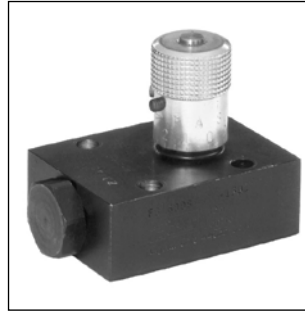

$$\text{Flow rate } Q \text{ [l/min]} = K_v \cdot \sqrt{\frac{\Delta p}{\gamma}}$$

K_v from the table
 Δp [bar]
 γ [kg/dm³] = specific gravity of fluid
 (γ for mineral oil = 0.85 – 0.9)

5

Characteristic values

		Δ						
400 ¹⁾	210	25	0.37	18.6	0.13	6.3	0.23	
600 ¹⁾	210	40	0.62	30.4	0.22	11.2	0.31	
800 ¹⁾	210	50	0.86	43.4	0.28	14	0.67	
1200 ¹⁾	210	120	1.18	60	0.70	35.4	1.17	
1600 ¹⁾	210	250	2.23	111	1.48	75	2.31	

¹⁾ MTTF_D value 150 years

Ordering code

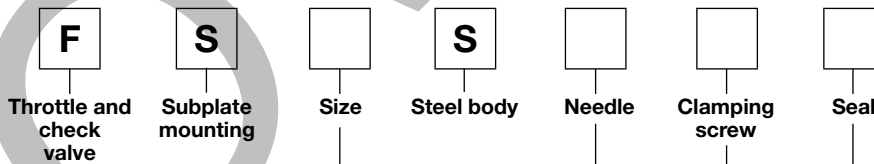

Code	Size
400	400
600	600
800	800
1200	1200
1600	1600

Code	Needle
omit	Standard 2 stage needle
4 ¹⁾	Micro-fine hollow needle with slot

Code	Seal
omit	NBR
V	FPM

Code	Clamping screw
omit	Hexagon socket
F	With knurled knob

Bold letters = Short-term availability

¹⁾ Only for sizes 400 to 600.

Δp/Q performance curves

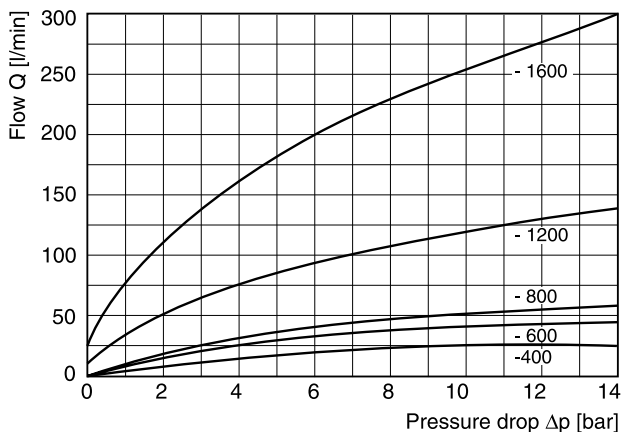

Δp/Q performance curves free flow

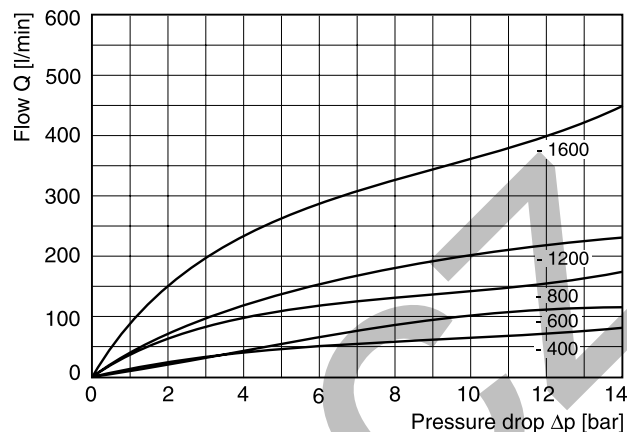

All characteristic curves measured with HLP46 at 50 °C.

5

Dimensions

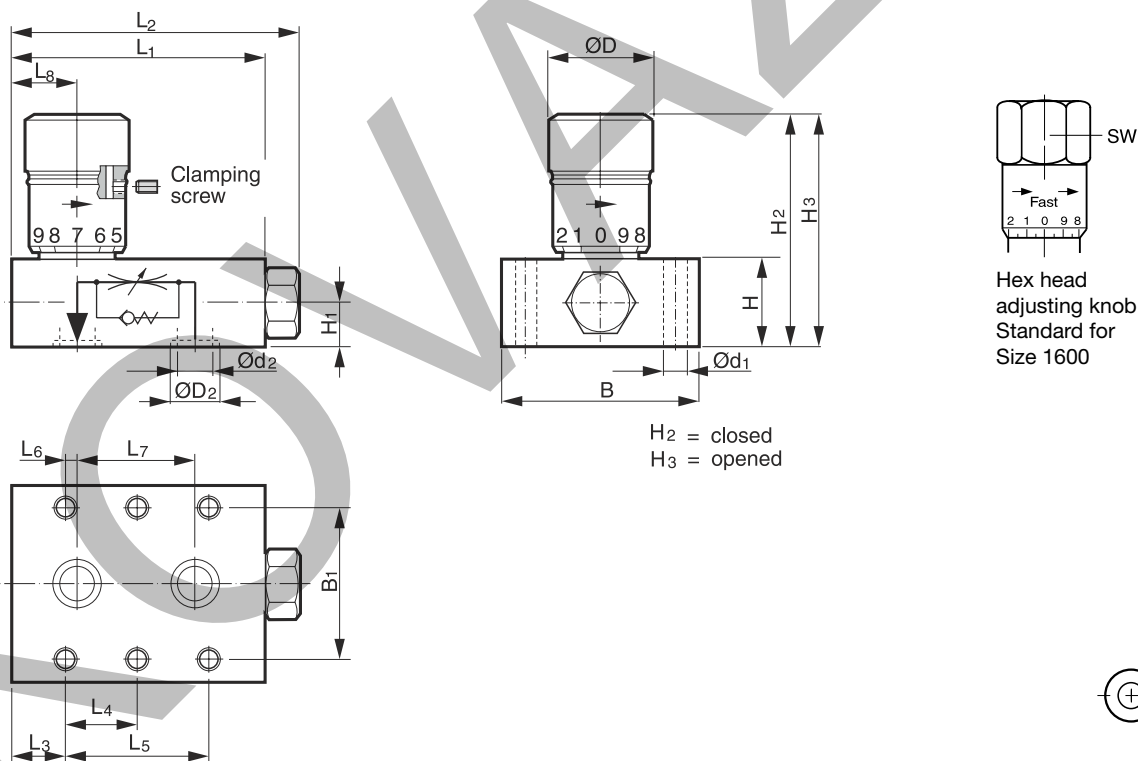

H₂ = closed
H₃ = opened

Size	L1	L2	L3	L4	L5	L6	L7	L8	B	B1	H	H1	H2	H3	Ød1	Ød2	ØD2	ØD	SW
FS400	63.5	71.4	14.2	-	35.1	4.9	25.4	21.3	44.5	33.3	22.1	10.9	51.1	56.1	6.8	7.1	13.3	20.6	-
FS600	69.9	78.0	18.3	-	33.3	4.1	25.4	25.4	50.8	38.1	25.4	12.7	61.0	67.3	7.0	10.4	16	25.4	-
FS800	81.0	89.2	21.3	-	38.1	4.1	30.2	30.7	57.2	44.5	31.8	15.7	76.2	83.6	7.0	11.9	19.1	30.0	-
FS1200	103.9	114.6	14.0	38.1	76.2	11.2	54.1	38.6	69.9	54.1	44.5	22.1	95.5	110.5	9.0	16.8	24	34.8	-
FS1600	127.0	137.7	15.7	47.8	95.5	19.3	56.9	45.2	76.2	60.5	50.8	25.4	129.5	146.3	9.0	22.4	32	-	47.5