

aerospace
climate control
electromechanical
filtration
fluid & gas handling
hydraulics
pneumatics
process control
sealing & shielding

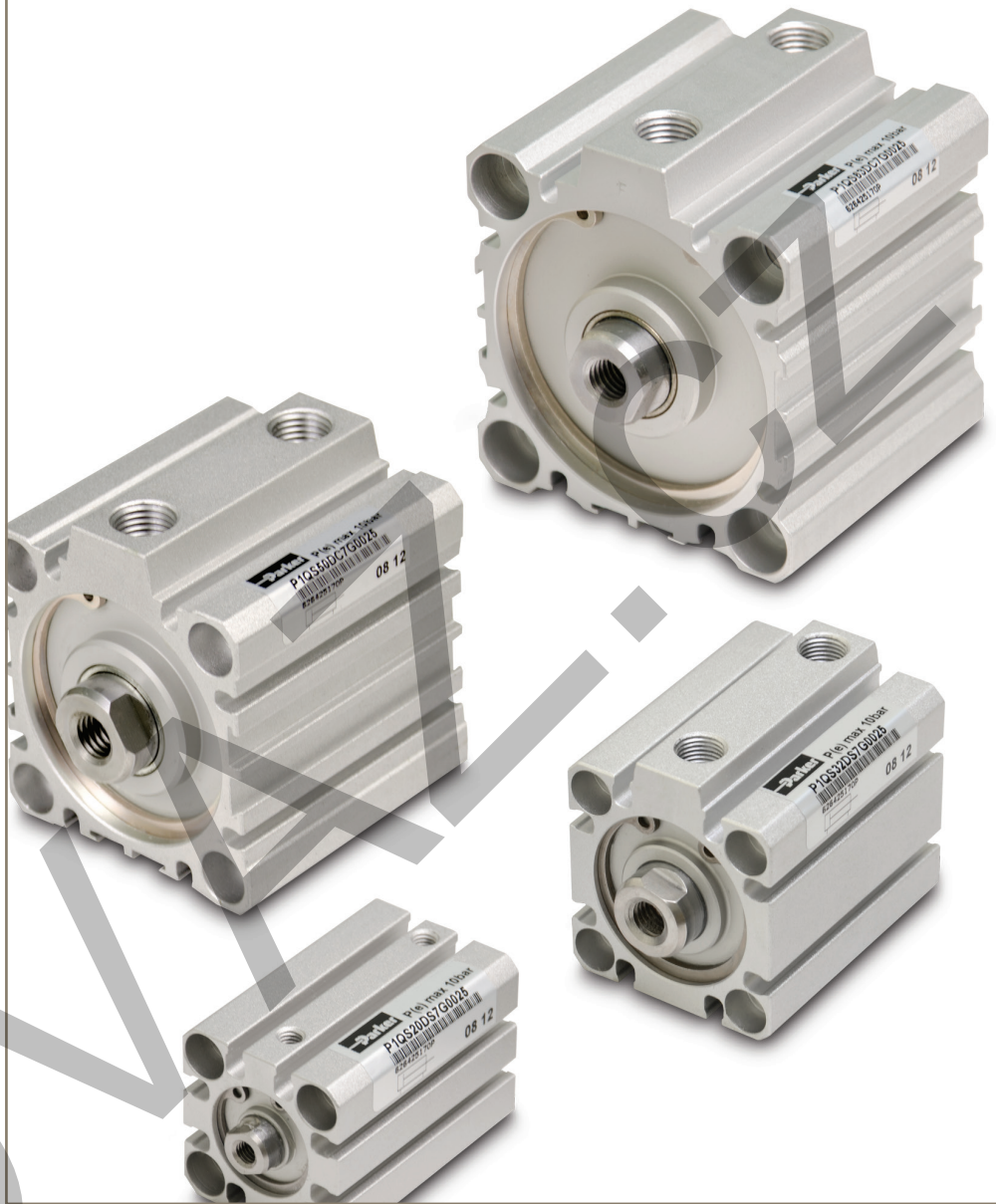
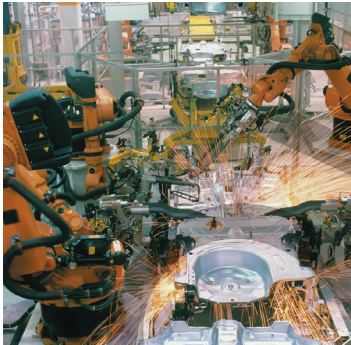

Pneumatic Cylinders

Series P1Q Compact - Ø12 to Ø100 mm

According to ISO 15524

Catalogue PDE2663TCUK February 2015



ENGINEERING YOUR SUCCESS.

Features.....	3
Technical Information	
Main data	4
Material specification	4
Working medium, air quality	4
Cylinder forces	5
Front profiles by bore size	5
Application Guide.....	6
Dimensions	
Non-magnetic.....	7
Magnetic.....	8
Order code key.....	9
Part numbers - Double acting / Non magnetic	10
Part numbers - Double acting / Magnetic	11
Mountings	
Flange.....	12
Foot	12
Clevis.....	13
Accessories	
Sensors	14-16

⚠ WARNING

FAILURE OR IMPROPER SELECTION OR IMPROPER USE OF THE PRODUCTS AND/OR SYSTEMS DESCRIBED HEREIN OR RELATED ITEMS CAN CAUSE DEATH, PERSONAL INJURY AND PROPERTY DAMAGE.

This document and other information from Parker Hannifin Corporation, its subsidiaries and authorized distributors provide product and/or system options for further investigation by users having technical expertise. It is important that you analyze all aspects of your application including consequences of any failure, and review the information concerning the product or system in the current product catalog. Due to the variety of operating conditions and applications for these products or systems, the user, through its own analysis and testing, is solely responsible for making the final selection of the products and systems and assuring that all performance, safety and warning requirements of the application are met.

The products described herein, including without limitation, product features, specifications, designs, availability and pricing, are subject to change by Parker Hannifin Corporation and its subsidiaries at any time without notice.

Offer of Sale

The items described in this document are hereby offered for sale by Parker Hannifin Corporation, its subsidiaries or its authorized distributors. This offer and its acceptance are governed by the provisions stated on the separate page of this document entitled "Offer of Sale".

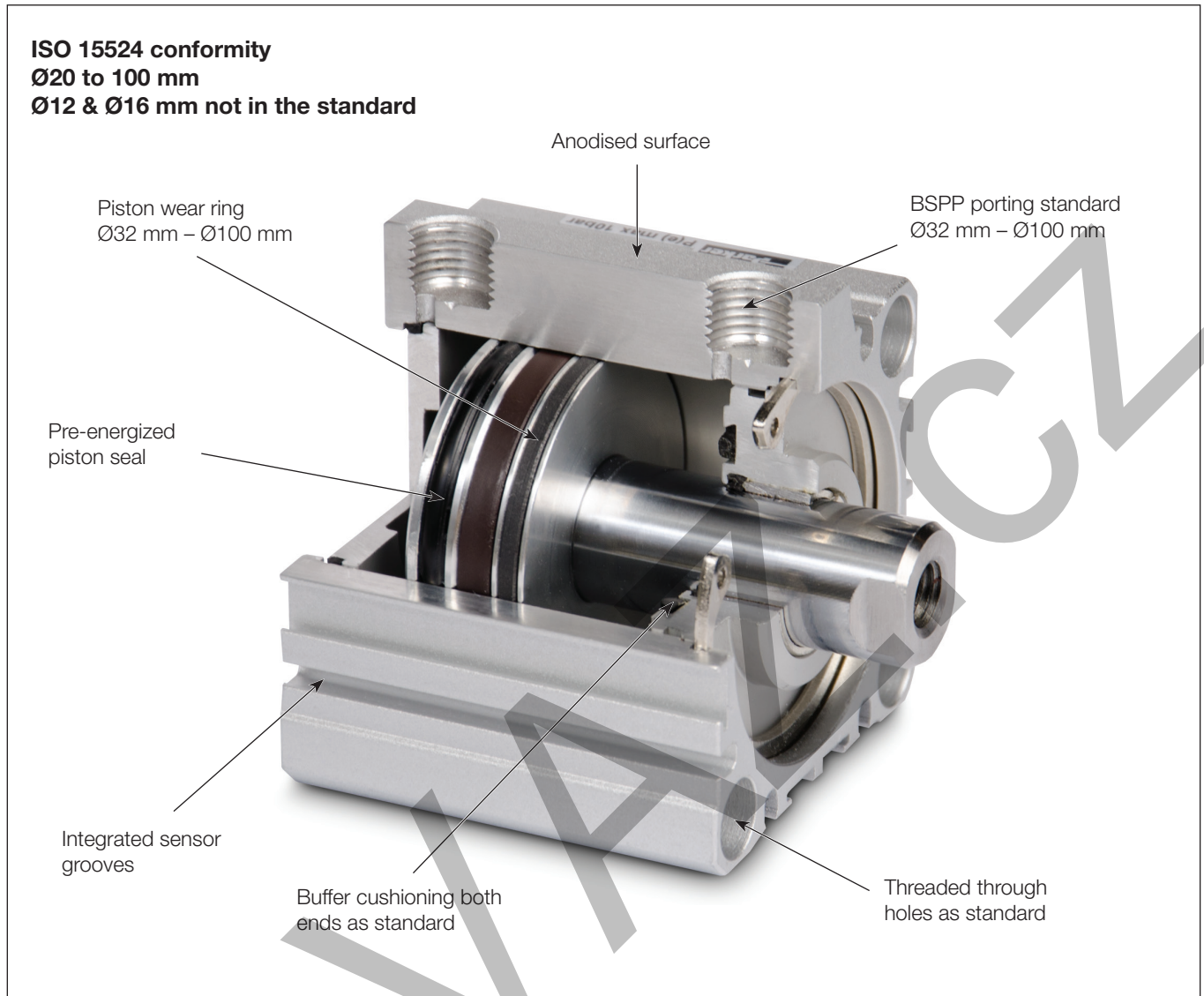

P1Q Compact Cylinder

Parker's P1Q series cylinders provide an economical, compact design suited for a variety of applications. With its modular flexibility, the P1Q will provide the ideal solution machine builders need today.

The P1Q series is available in 10 bore sizes from 12 mm to 100 mm and standard strokes from 5 mm to 100 mm. The cylinder is supplied in a choice of magnetic or non-magnetic function, the non-magnetic version offers very short axial dimensions. For optimum compactness the P1Q range is supplied with female piston rod thread.

The P1Q provides quieter operation due to its built in buffer cushioning which is standard on all bore sizes. Included within the magnetic versions bores 32 - 100 mm is a teflon piston wear ring providing superior life.

Sensors and Accessories

When position signals are needed anywhere along the stroke the integrated sensor grooves provide flexible mounting of any combination of PNP, NPN, reed sensors with flying leads and M8 cord options within the Parker P8S Global Sensor Family.

In addition to the compactness and modular design flexibility of P1Q are a range of cylinder mountings including flange, foot and clevis brackets to ease installation.

General technical data

Product type	Compact	
Bore size	12 - 100 mm	
Stroke length	100 mm	
Versions	P1Q...B	Double acting, Non magnetic
	P1Q...G	Double acting, Magnetic
Cushioning	Elastic cushioning	
Position sensing	Proximity sensor	
Installation	Direct	Through holes
		Female thread on front and rear end face
	Accessories	Cylinder mountings
Mounting position	Any	

Operating and environmental data

Operating medium	For best possible service life and trouble-free operation it is recommended to use dry, filtered compressed air to ISO 8573-1:2010 quality class 3.4.3. This specifies a dew point of +3°C for indoor operation (a lower dew point should be selected for outdoor operation) and is in line with the air quality from most standard compressors with a standard filter. Refer to page 22.
Operating pressure	0.5 bar to 10 bar
Ambient temperature	-5°C to +60°C
Pre-lubricated	Further lubrication is normally not necessary. If additional lubrication is introduced it must be continued.
Corrosion resistance	High resistance to corrosion and chemicals. Materials and surface treatment have been selected for industrial applications where solvents and detergents are frequently used.

Material specification

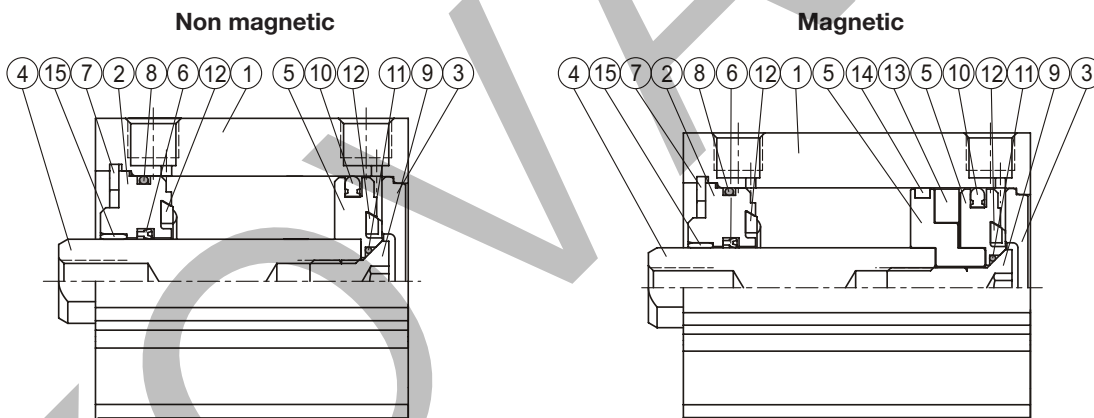

No	Part name / bore	12 - 25	32	40 - 100
1	Body	Hard anodised aluminium alloy		
2	Front cover	Hard anodised aluminium alloy	Anodised aluminium alloy	
3	Rear cover	Anodised aluminium alloy		
4	Piston rod	Stainless steel	Medium carbon steel	
5	Piston	Anodised aluminium alloy		
6	Piston rod seal	NBR		
7	Circlip	Stainless steel	Spring steel	
8	O ring	NBR		
9	Piston bolt	Stainless steel	SCM	
10	Piston seal	NBR		
11	Piston gasket	NBR		
12	Buffer	NBR		
13	Magnet	Plastic		
14	Wear ring	-	Teflon	
15	Bush	-	-	Bearing alloy

Main data: P1Q

Cylinder designation	Cylinder bore area		Piston rod area		Thread (female)	at	addition	Air consumption	Port size
	mm	cm ²	mm	cm ²		0 mm stroke	per 5 mm stroke		
P1Q012	12	1.1	6	0.28	M3 x 0.5	0.06	0.01	0.0139 ¹⁾	M5
P1Q016	16	2.0	8	0.50	M4 x 0.7	0.07	0.02	0.0246 ¹⁾	M5
P1Q020	20	3.1	10	0.79	M5 x 0.8	0.09	0.03	0.0385 ¹⁾	M5
P1Q025	25	4.9	12	1.1	M6 x 1.0	0.13	0.03	0.0633 ¹⁾	M5
P1Q032	32	8.0	16	2.0	M8 x 1.25	0.19	0.03	0.1050 ¹⁾	G1/8
P1Q040	40	12.6	16	2.0	M8 x 1.25	0.25	0.03	0.1620 ¹⁾	G1/8
P1Q050	50	19.6	20	3.1	M10 x 1.5	0.45	0.04	0.2530 ¹⁾	G1/4
P1Q063	63	31.2	20	3.1	M10 x 1.5	0.68	0.05	0.4140 ¹⁾	G1/4
P1Q080	80	50.3	25	4.9	M16 x 2.0	1.25	0.07	0.6690 ¹⁾	G3/8
P1Q100	100	78.5	30	7.0	M20 x 2.5	1.93	0.15	1.0430 ¹⁾	G3/8

¹⁾ Free air consumption per 10 mm stroke length for a double stroke at 6 bar

Cylinder forces, double acting variants

Cyl. bore/ pist. rod mm	Stroke	Piston area cm ²	Max theoretical force in N (bar)									
			1.0	2.0	3.0	4.0	5.0	6.0	7.0	8.0	9.0	10.0
12/6	+	1.1	11	23	34	45	57	68	79	90	102	113
	-	0.8	8	17	25	34	42	51	59	68	76	85
16/8	+	2.0	20	40	60	80	101	121	141	161	181	201
	-	1.5	15	30	45	60	75	90	106	121	136	151
20/10	+	3.1	31	63	94	126	157	188	220	251	283	314
	-	2.4	24	47	71	94	118	141	165	188	212	236
25/12	+	4.9	49	98	147	196	245	295	344	393	442	491
	-	3.8	38	76	113	151	189	227	264	302	340	378
32/16	+	8.0	80	161	241	322	402	483	563	643	724	804
	-	6.0	60	121	181	241	302	362	422	483	543	603
40/16	+	12.6	126	251	377	503	628	754	880	1005	1131	1257
	-	10.6	106	211	317	422	528	633	739	844	950	1056
50/20	+	19.6	196	393	589	785	982	1178	1374	1571	1767	1963
	-	16.5	165	330	495	660	825	990	1155	1319	1484	1649
63/20	+	31.2	312	623	935	1247	1559	1870	2182	2494	2806	3117
	-	28.0	280	561	841	1121	1402	1682	1962	2242	2523	2803
80/25	+	50.3	503	1005	1508	2011	2513	3016	3519	4021	4524	5027
	-	45.4	454	907	1361	1814	2268	2721	3175	3629	4082	4536
100/30	+	78.5	785	1571	2356	3142	3927	4712	5498	6283	7069	7854
	-	71.5	715	1430	2145	2860	3575	4290	5005	5720	6435	7150

+ = Outward stroke
- = Return stroke

Note:
Select a theoretical force 50-100% larger than the force required

Front profiles by bore sizes

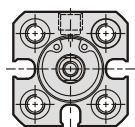

Ø12

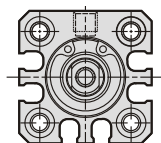

Ø16

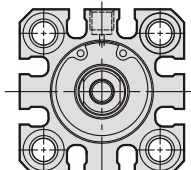

Ø20, Ø25

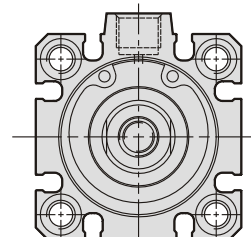

Ø32, Ø40

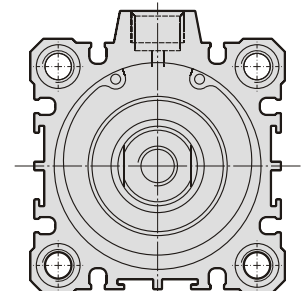

Ø50 to Ø100

Selecting Pneumatic System Components

Cylinder to Valve: T

The below chart contains recommendations for selecting air valve products based on 5.5 bar with a 0.35 bar pressure drop. The values within the chart show the corresponding Cv values.

Moduflex Valve System

- Stand-alone valves, short-build valve manifold, or large valve manifold configurations available
- Cv range from 0.18 – 0.80
- Peripheral modules available— flow control, pressure regulation, P.O. check valves and vacuum generators



Cylinder speed (mm/s)	Cylinder bore size									
	12	16	20	25	32	40	50	63	80	100
50	0.004	0.01	0.01	0.02	0.03	0.04	0.06	0.10	0.16	0.26
100	0.01	0.01	0.02	0.03	0.05	0.08	0.13	0.20	0.33	0.51
150	0.01	0.02	0.03	0.05	0.08	0.12	0.19	0.30	0.49	0.77
200	0.01	0.03	0.04	0.06	0.10	0.16	0.26	0.41	0.65	1.02
250	0.02	0.03	0.05	0.08	0.13	0.20	0.32	0.51	0.82	1.28
300	0.02	0.04	0.06	0.10	0.16	0.25	0.38	0.61	0.98	1.53
350	0.03	0.05	0.07	0.11	0.18	0.29	0.45	0.71	1.15	1.79
400	0.03	0.05	0.08	0.13	0.21	0.33	0.51	0.81	1.31	2.04
450	0.03	0.06	0.09	0.14	0.24	0.37	0.58	0.91	1.47	2.30
500	0.04	0.07	0.10	0.16	0.26	0.41	0.64	1.01	1.64	2.56
Size 1					Size 2			See Larger valve system		

Isys Micro / ISO Valve System

- Isys Micro Cv range 0.30 – 0.35
- IsysNet system fieldbus, Turck system fieldbus, 25 pin D-sub, or low cost Moduflex fieldbus options available
- Isys ISO offers 5 sizes with Cv range 0.55 – 6.0



Cylinder speed (mm/s)	Cylinder bore size										Valve range
	12	16	20	25	32	40	50	63	80	100	
50	0.004	0.01	0.01	0.02	0.03	0.04	0.06	0.10	0.16	0.26	Isys Micro
100	0.01	0.01	0.02	0.03	0.05	0.08	0.13	0.20	0.33	0.51	
150	0.01	0.02	0.03	0.05	0.08	0.12	0.19	0.30	0.49	0.77	HA
200	0.01	0.03	0.04	0.06	0.10	0.16	0.26	0.41	0.65	1.02	
250	0.02	0.03	0.05	0.08	0.13	0.20	0.32	0.51	0.82	1.28	H1
300	0.02	0.04	0.06	0.10	0.16	0.25	0.38	0.61	0.98	1.53	
350	0.03	0.05	0.07	0.11	0.18	0.29	0.45	0.71	1.15	1.79	H2
400	0.03	0.05	0.08	0.13	0.21	0.33	0.51	0.81	1.31	2.04	
450	0.03	0.06	0.09	0.14	0.24	0.37	0.58	0.91	1.47	2.30	
500	0.04	0.07	0.10	0.16	0.26	0.41	0.64	1.01	1.64	2.56	

Dimensions (mm)

Double acting, non magnetic piston, elastic cushioning, piston rod with internal thread

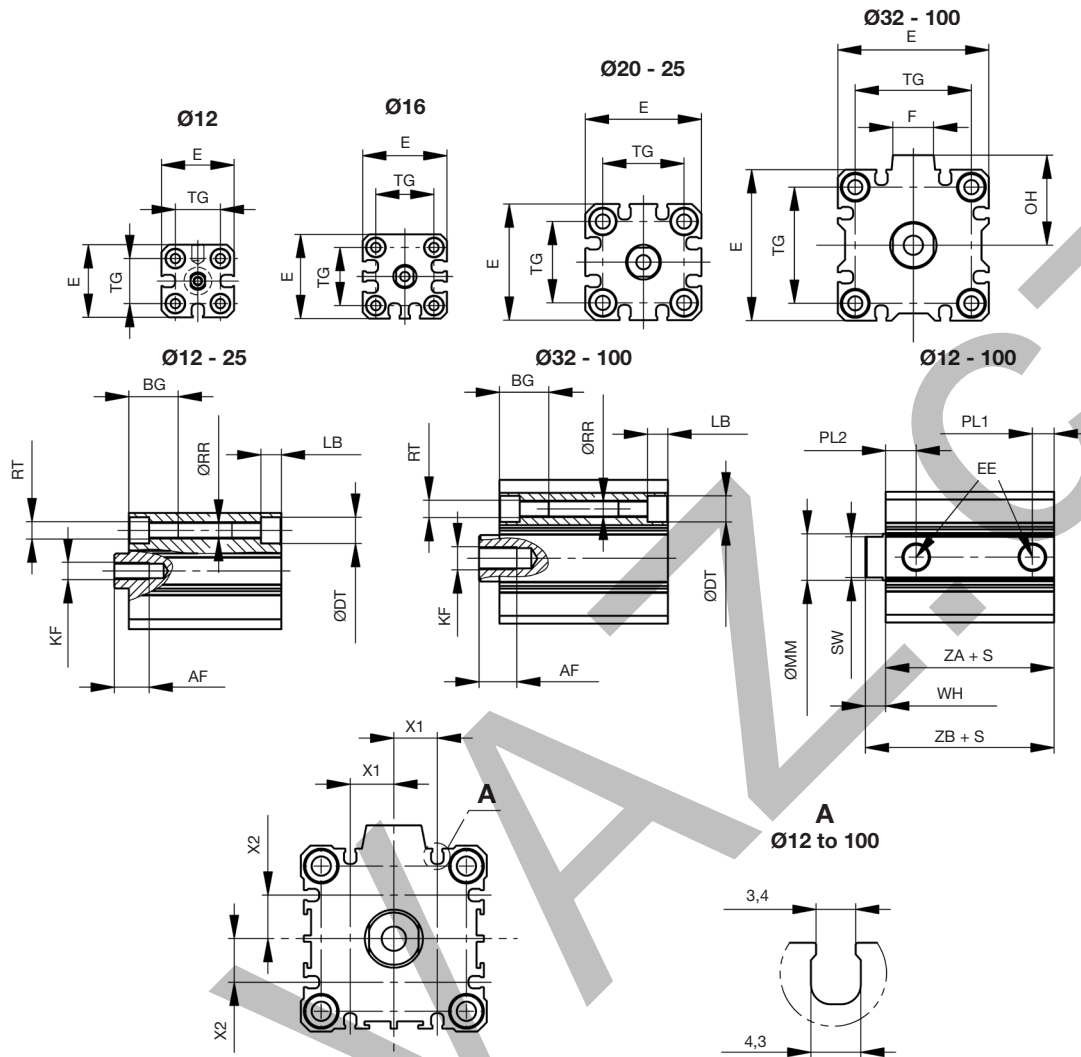

The non magnetic version is not in the ISO standard, ZA and ZB could be different depending on the cylinder's manufacturer
 WH and ZB are without pressure in the cylinder, deformation of elastic bumpers under pressure gives different dimensions

Bore size Ø [mm]	E	TG	F	OH	RT 6H	BG	KF	AF	ØRR	LB	ØDT	ØMM	SW	PL1	PL2	EE	X1	X2	WH	ZA		ZB	
																				5 to 50mm	75 to 100mm	5 to 50mm	75 to 100mm
12	25	15.5 ±0.3	-	12.5	M4	11.0	M3	6	3.5	4.0	6.5	6	5	5.0	7.5	M5	0	0	3.5 ±1.5	17.0	-	20.5	-
16	29	20 ±0.3	-	14.5	M4	11.0	M4	8	3.5	4.0	6.5	8	6	5.0	7.5	M5	3.5	3.5	3.5 ±1.5	17.0	-	20.5	-
20	36	25.5 ±0.3	7.6	18.0	M6	17.0	M5	7	5.4	7.0	9.0	10	8	5.5	9.0	M5	5.5	5.5	4.5 ±1.5	19.5	-	24.0	-
25	40	28 ±0.3	16.4	20.0	M6	17.0	M6	12	5.4	7.0	9.0	12	10	5.5	11.0	M5	6.5	6.5	5 ±1.5	22.5	-	27.5	-
32	45	34 ±0.3	14.0	27.0	M6	17.0	M8	13	5.5	7.0	9.0	16	14	7.5	10.5	G1/8	10.0	10.0	7 ±2	23.0	33.0	30.0	40.0
40	52	40 ±0.3	14.0	31.0	M6	17.0	M8	13	5.5	7.0	9.0	16	14	8.0	11.0	G1/8	11.0	11.0	7 ±2	29.5	39.5	36.5	46.5
50	64	50 ±0.5	26.0	39.0	M8	22.0	M10	15	6.6	8.0	11.0	20	17	10.5	10.5	G1/4	15.0	15.0	8 ±2	30.5	40.5	38.5	48.5
63	77	60 ±0.5	19.0	44.5	M10	28.5	M10	15	9.0	10.5	14.0	20	17	10.5	15.0	G1/4	18.0	18.0	8 ±2	36.0	46.0	44.0	54.0
80	98	77 ±0.5	26.0	55.0	M12	35.5	M16	21	11.0	13.5	17.5	25	22	12.5	16.0	G3/8	22.0	22.0	10 ±2	43.5	53.5	53.5	63.5
100	117	94 ±0.5	26.0	65.0	M12	35.5	M20	27	11.0	13.5	17.5	30	27	13.0	23.0	G3/8	22.0	22.0	12 ±2.5	53.0	63.0	65.0	75.0

S = stroke, following ISO tolerance on ZB is ±2, bore sizes 12 and 16 mm are not in the ISO standard

Dimensions (mm)

Double acting, magnetic piston, elastic cushioning, piston rod with internal thread

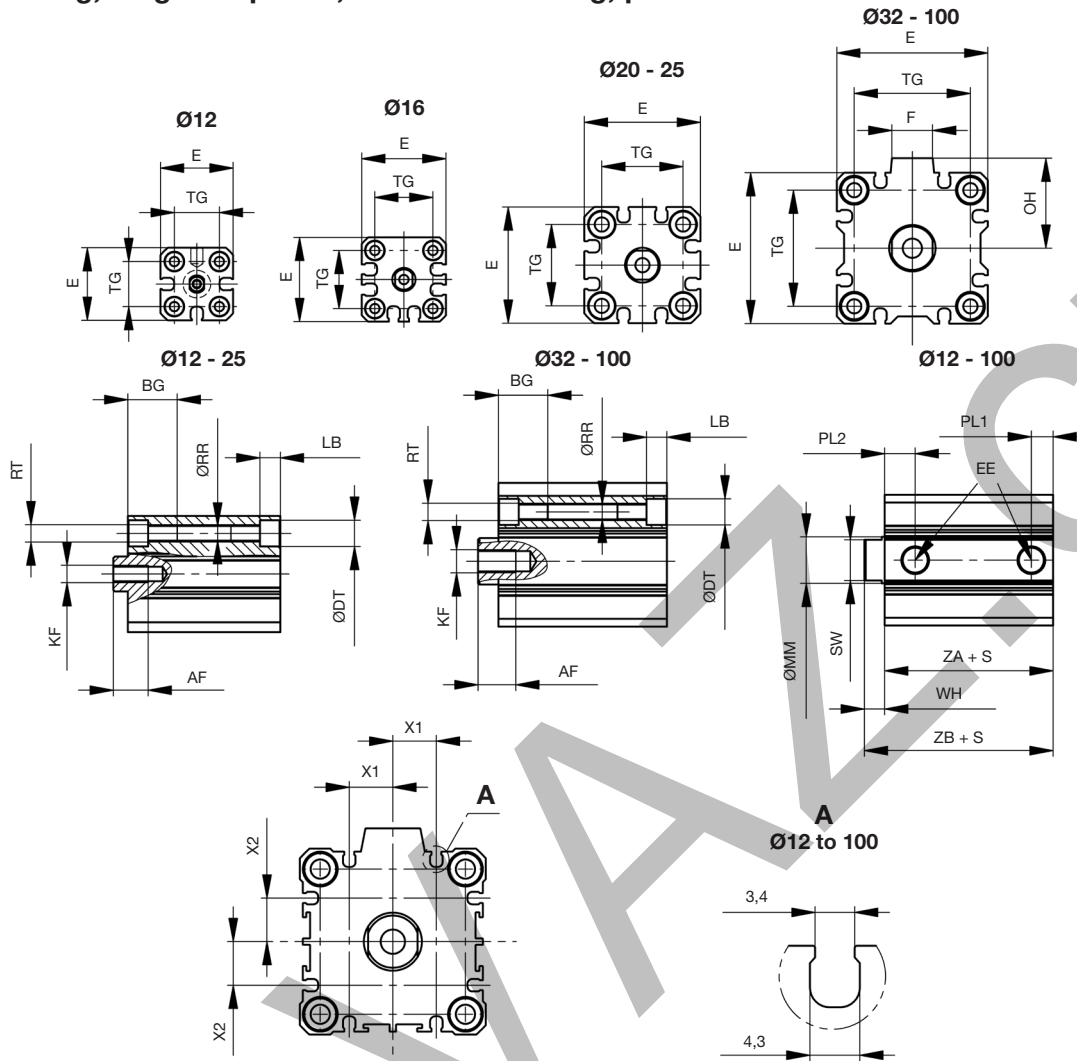

WH and ZB are without pressure in the cylinder, deformation of elastic bumpers under pressure gives different dimensions

Bore size Ø [mm]	E	TG	F	OH	RT 6H	BG	K	AF	ØRR	LB	ØDT	ØMM f8	SW	PL1	PL2	EE	X1	X2	WH	ZA	ZB
12	25	15.5 ±0.3	-	12.5	M4	11.0	M3	6	3.5	4.0	6.5	6	5	5.0	7.5	M5	0	0	3.5 ±1.5	22.0	25.5
16	29	20 ±0.3	-	14.5	M4	11.0	M4	8	3.5	4.0	6.5	8	6	5.0	7.5	M5	3.5	3.5	3.5 ±1.5	22.0	25.5
20	36	25.5 ±0.3	7.6	18.0	M6	17.0	M5	7	5.4	7.0	9.0	10	8	5.5	9.0	M5	5.5	5.5	4.5 ±1.5	29.5	34.0
25	40	28 ±0.3	16.4	20.0	M6	17.0	M6	12	5.4	7.0	9.0	12	10	5.5	11.0	M5	6.5	6.5	5 ±1.5	32.5	37.5
32	45	34 ±0.3	14.0	27.0	M6	17.0	M8	13	5.5	7.0	9.0	16	14	7.5	10.5	G1/8	10.0	10.0	7 ±2	33.0	40.0
40	52	40 ±0.3	14.0	31.0	M6	17.0	M8	13	5.5	7.0	9.0	16	14	8.0	11.0	G1/8	11.0	11.0	7 ±2	39.5	46.5
50	64	50 ±0.5	26.0	39.0	M8	22.0	M10	15	6.6	8.0	11.0	20	17	10.5	10.5	G1/4	15.0	15.0	8 ±2	40.5	48.5
63	77	60 ±0.5	19.0	44.5	M10	28.5	M10	15	9.0	10.5	14.0	20	17	10.5	15.0	G1/4	18.0	18.0	8 ±2	46.0	54.0
80	98	77 ±0.5	26.0	55.0	M12	35.5	M16	21	11.0	13.5	17.5	25	22	12.5	16.0	G3/8	22.0	22.0	10 ±2	53.5	63.5
100	117	94 ±0.5	26.0	65.0	M12	35.5	M20	27	11.0	13.5	17.5	30	27	13.0	23.0	G3/8	22.0	22.0	12 ±2.5	63.0	75.0

S = stroke, following ISO tolerance on ZB is ±2, bore sizes 12 and 16 mm are not in the ISO standard

Order Code Key

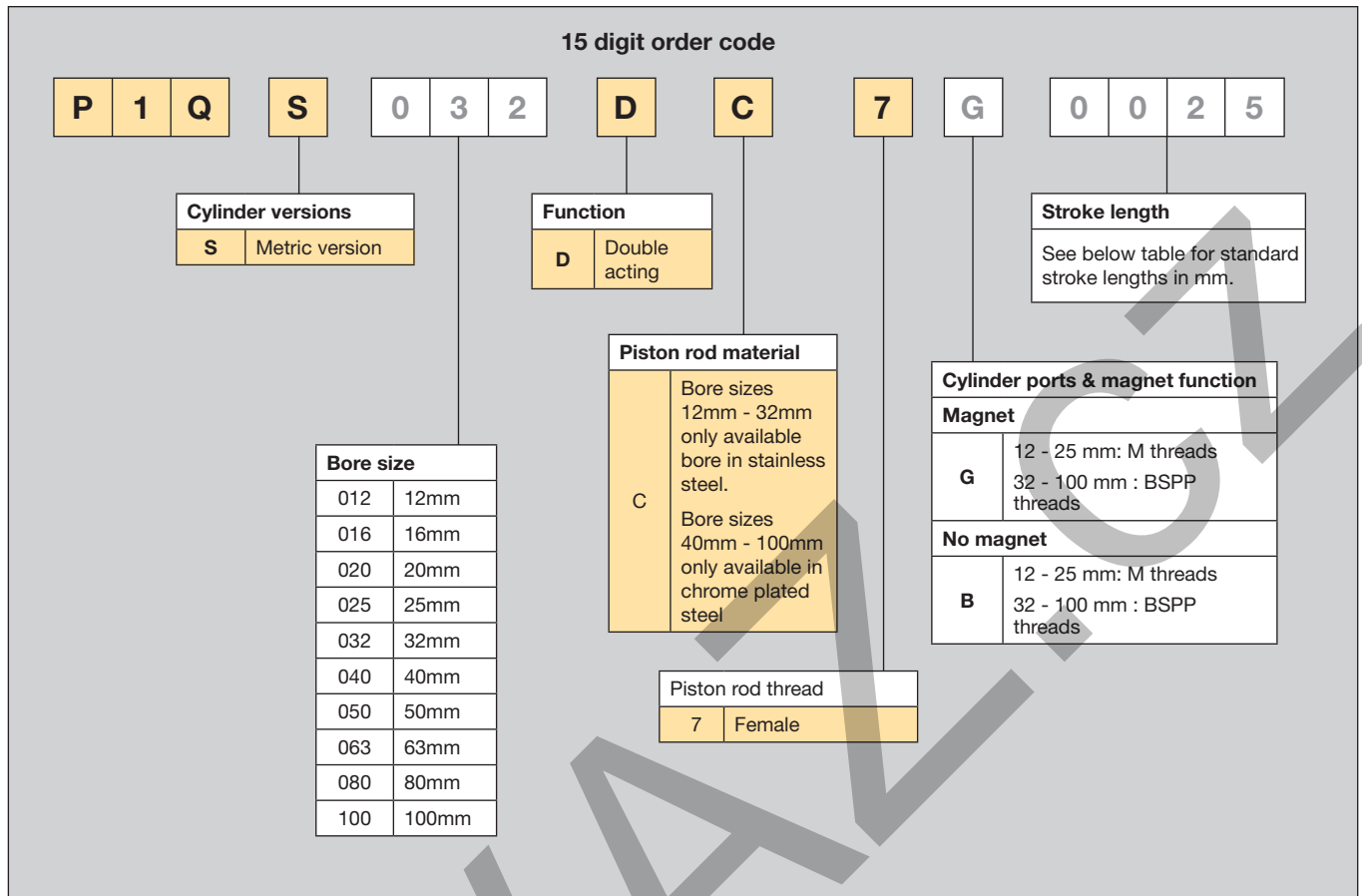

Standard strokes (mm)

Bore size [mm]	5	10	15	20	25	30	40	50	75	100
12 - 16	•	•	•	•	•	•				
20 - 25		•	•	•	•	•	•	•		
32		•	•	•	•	•	•	•	•	•
40 - 50			•	•	•	•	•	•	•	•
63 - 100			•	•	•	•	•	•	•	

**Double Acting/Non Magnetic -
Female Threaded Piston Rod**

ISO 15524 - Ø20 to 100

Ø12 & 16 not in the ISO standard



12 mm

Stroke [mm]	Order Code
5	P1QS012DC7B0005
10	P1QS012DC7B0010
15	P1QS012DC7B0015
20	P1QS012DC7B0020
25	P1QS012DC7B0025
30	P1QS012DC7B0030

16 mm

5	P1QS016DC7B0005
10	P1QS016DC7B0010
15	P1QS016DC7B0015
20	P1QS016DC7B0020
25	P1QS016DC7B0025
30	P1QS016DC7B0030

20 mm

10	P1QS020DC7B0010
15	P1QS020DC7B0015
20	P1QS020DC7B0020
25	P1QS020DC7B0025
30	P1QS020DC7B0030
40	P1QS020DC7B0040
50	P1QS020DC7B0050

25 mm

10	P1QS025DC7B0010
15	P1QS025DC7B0015
20	P1QS025DC7B0020
25	P1QS025DC7B0025
30	P1QS025DC7B0030
40	P1QS025DC7B0040
50	P1QS025DC7B0050

32 mm

Stroke [mm]	Order Code
10	P1QS032DC7B0010
15	P1QS032DC7B0015
20	P1QS032DC7B0020
25	P1QS032DC7B0025
30	P1QS032DC7B0030
40	P1QS032DC7B0040
50	P1QS032DC7B0050
75	P1QS032DC7B0075
100	P1QS032DC7B0100

40 mm

15	P1QS040DC7B0015
20	P1QS040DC7B0020
25	P1QS040DC7B0025
30	P1QS040DC7B0030
40	P1QS040DC7B0040
50	P1QS040DC7B0050
75	P1QS040DC7B0075
100	P1QS040DC7B0100

50 mm

15	P1QS050DC7B0015
20	P1QS050DC7B0020
25	P1QS050DC7B0025
30	P1QS050DC7B0030
40	P1QS050DC7B0040
50	P1QS050DC7B0050
75	P1QS050DC7B0075
100	P1QS050DC7B0100

63 mm

Stroke [mm]	Order Code
15	P1QS063DC7B0015
20	P1QS063DC7B0020
25	P1QS063DC7B0025
30	P1QS063DC7B0030
40	P1QS063DC7B0040
50	P1QS063DC7B0050
75	P1QS063DC7B0075

80 mm

15	P1QS080DC7B0015
20	P1QS080DC7B0020
25	P1QS080DC7B0025
30	P1QS080DC7B0030
40	P1QS080DC7B0040
50	P1QS080DC7B0050
75	P1QS080DC7B0075

100 mm

15	P1QS100DC7B0015
20	P1QS100DC7B0020
25	P1QS100DC7B0025
30	P1QS100DC7B0030
40	P1QS100DC7B0040
50	P1QS100DC7B0050
75	P1QS100DC7B0075

Double Acting/Magnetic -
 Female Threaded Piston Rod
 ISO 15524 - Ø20 to 100
 Ø12 & 16 not in the ISO standard

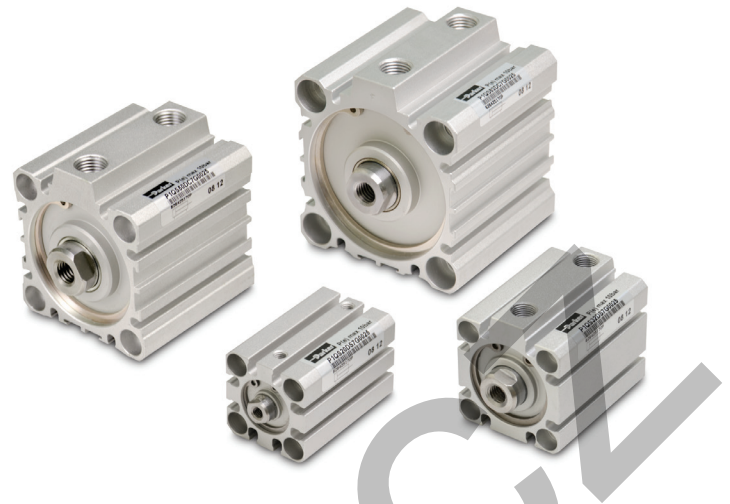

12 mm

Stroke [mm]	Order Code
5	P1QS012DC7G0005
10	P1QS012DC7G0010
15	P1QS012DC7G0015
20	P1QS012DC7G0020
25	P1QS012DC7G0025
30	P1QS012DC7G0030

16 mm

5	P1QS016DC7G0005
10	P1QS016DC7G0010
15	P1QS016DC7G0015
20	P1QS016DC7G0020
25	P1QS016DC7G0025
30	P1QS016DC7G0030

20 mm

10	P1QS020DC7G0010
15	P1QS020DC7G0015
20	P1QS020DC7G0020
25	P1QS020DC7G0025
30	P1QS020DC7G0030
40	P1QS020DC7G0040
50	P1QS020DC7G0050

25 mm

10	P1QS025DC7G0010
15	P1QS025DC7G0015
20	P1QS025DC7G0020
25	P1QS025DC7G0025
30	P1QS025DC7G0030
40	P1QS025DC7G0040
50	P1QS025DC7G0050

32 mm

Stroke [mm]	Order Code
10	P1QS032DC7G0010
15	P1QS032DC7G0015
20	P1QS032DC7G0020
25	P1QS032DC7G0025
30	P1QS032DC7G0030
40	P1QS032DC7G0040
50	P1QS032DC7G0050
75	P1QS032DC7G0075
100	P1QS032DC7G0100

40 mm

15	P1QS040DC7G0015
20	P1QS040DC7G0020
25	P1QS040DC7G0025
30	P1QS040DC7G0030
40	P1QS040DC7G0040
50	P1QS040DC7G0050
75	P1QS040DC7G0075
100	P1QS040DC7G0100

50 mm

15	P1QS050DC7G0015
20	P1QS050DC7G0020
25	P1QS050DC7G0025
30	P1QS050DC7G0030
40	P1QS050DC7G0040
50	P1QS050DC7G0050
75	P1QS050DC7G0075
100	P1QS050DC7G0100

63 mm

Stroke [mm]	Order Code
15	P1QS063DC7G0015
20	P1QS063DC7G0020
25	P1QS063DC7G0025
30	P1QS063DC7G0030
40	P1QS063DC7G0040
50	P1QS063DC7G0050
75	P1QS063DC7G0075

80 mm

15	P1QS080DC7G0015
20	P1QS080DC7G0020
25	P1QS080DC7G0025
30	P1QS080DC7G0030
40	P1QS080DC7G0040
50	P1QS080DC7G0050
75	P1QS080DC7G0075

100 mm

15	P1QS100DC7G0015
20	P1QS100DC7G0020
25	P1QS100DC7G0025
30	P1QS100DC7G0030
40	P1QS100DC7G0040
50	P1QS100DC7G0050
75	P1QS100DC7G0075

Flange

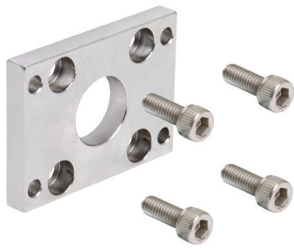

Intended for fixed mounting of cylinder. Flange can be fitted to front or rear of cylinder.

Material

Flange: surface treated steel

Supplied complete with mounting screws for attachment to cylinder.

Ø12 to Ø25

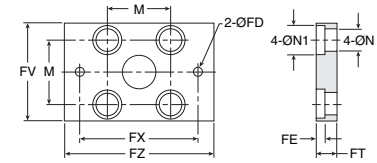

Ø32 to Ø100

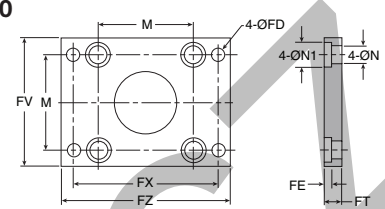

Bore [mm]	FD [mm]	FT [mm]	FV [mm]	FX [mm]	FZ [mm]	M [mm]	N [mm]	N1 [mm]	Weight [kg]	Part number
12	4.5	5.5	25	45	55	15.5	4.5	7.5	0.08	P1Q-4DMB
16	4.5	5.5	30	45	55	20	4.5	7.5	0.10	P1Q-4FMB
20	6.5	8	39	48	60	25.5	6.5	10.5	0.16	P1Q-4HMB
25	6.5	8	42	52	64	28	6.5	10.5	0.20	P1Q-4JMB
32	5.5	8	48	56	65	34	6.5	10.5	0.23	P1Q-4KMB
40	5.5	8	54	62	72	40	6.5	10.5	0.28	P1Q-4LMB
50	6.5	9	67	76	89	50	8.5	13.5	0.53	P1Q-4MMB
63	9	9	80	92	108	60	10.5	16.5	0.71	P1Q-4NMB
80	11	11	99	116	134	77	12.5	18.5	1.59	P1Q-4PMB
100	11	11	117	136	154	94	12.5	18.5	2.19	P1Q-4QMB

Foot brackets MS9



Intended for fixed mounting of cylinder. Angle bracket can be fitted to front and rear of cylinder.

Material

Angle bracket: surface treated steel

Supplied in pairs with mounting screws for attachment to cylinder.

* Weight per item

Ø12 to Ø25

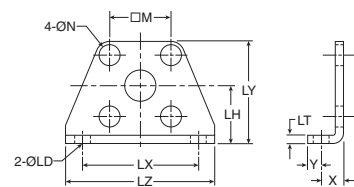

Ø32 to Ø100

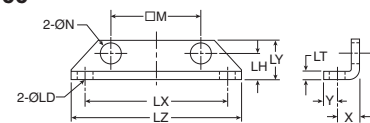

Bore [mm]	LD [mm]	LH [mm]	LT [mm]	LX [mm]	LY [mm]	LZ [mm]	X [mm]	Y [mm]	M [mm]	N [mm]	Weight (kg)	Part number
12	4.5	17	2	34	29.5	44	8	4.5	15.5	4.5	0.02*	P1Q-4DMF
16	4.5	19	2	38	33.5	48	8	5	20	4.5	0.02*	P1Q-4FMF
20	6.5	24	3.2	48	42	62	9.2	5.8	25.5	6.5	0.04*	P1Q-4HMF
25	6.5	26	3.2	52	46	66	10.7	5.8	28	6.5	0.05*	P1Q-4JMF
32	6.5	13	3.2	57	20	71	11.2	5.8	34	6.5	0.06*	P1Q-4KMF
40	6.5	13	3.2	64	20	78	11.2	7	40	6.5	0.08*	P1Q-4LMF
50	8.5	14	3.2	79	22	95	12.2	8	50	8.5	0.16*	P1Q-4MMF
63	10.5	16	3.2	95	26	113	13.7	9	60	10.5	0.25*	P1Q-4NMF
80	13	20.5	4.5	118	32	140	16.5	11	77	13	0.50*	P1Q-4PMF
100	13	24	6	137	36	162	23	11.5	94	13	0.85*	P1Q-4QMF

Clevis bracket

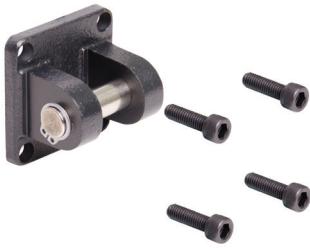

Intended for flexible mounting of cylinder. Clevis bracket can be fitted to the rear of cylinder.

Material

Clevis bracket: surface treated steel, black
 Supplied complete with mounting screws for attachment to cylinder.

Ø12 to Ø25

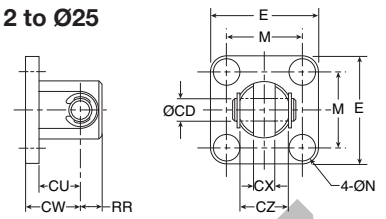

Ø32 to Ø100

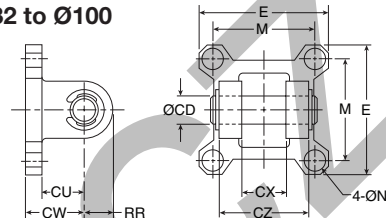

Bore [mm]	CD [mm]	CU [mm]	CW [mm]	CX [mm]	CZ [mm]	N [mm]	RR [mm]	M [mm]	E [mm]	Weight [kg]	Part number
12	5	9.5	14	5.3	9.8	4.5	6	15.5	25	0.02	P1Q-4DMT
16	5	10.5	15	6.8	11.8	4.5	6	20	29	0.03	P1Q-4FMT
20	8	12.5	18	8.3	15.8	6.5	9	25.5	36	0.05	P1Q-4HMT
25	10	14.5	20	10.3	19.8	6.5	10	28	40	0.06	P1Q-4JMT
32	10	14.5	20	18.3	35.8	6.5	10	34	45.5	0.08	P1Q-4KMT
40	10	15	22	18.3	35.8	6.5	10	40	53.5	0.11	P1Q-4LMT
50	14	20	28	22.3	43.8	8.5	14	50	64.5	0.14	P1Q-4MMT
63	14	21	30	22.3	43.8	10.5	14	60	77.5	0.29	P1Q-4NMT
80	18	28	38	28.3	55.8	12.5	18	77	98.5	0.36	P1Q-4PMT
100	22	32	45	32.3	63.8	12.5	22	94	117.5	0.64	P1Q-4QMT



Global P8S Sensor Series

The P8S family of sensors provides a broad range of reed and solid state sensor types with flying lead or M8 options available. Mounting on all cylinders is within the integrated sensor grooves allowing for compact installation. For 12mm and 16mm bores the sensors can be mounted on 3 sides and on 20mm to 100mm bores on four sides for flexible mounting and ease of installation.

Electronic Sensors

The electronic sensors utilise "Solid State" technology, providing operation with no moving parts. These switches are available in NPN and PNP type, both provide built in short circuit and transient protection as standard. The solid state operation allows for high switching on off frequency, ideal for applications where long service life is required.

Technical data

Design	GMR (Giant Magnetic Resistance) magneto-resistive function
Installation	Mounts within cylinder switch Groove
Outputs	PNP or NPN, normally open
Voltage range	5-30 V DC
Voltage drop	1.5 V max
Switching Current	50 mA max
Switch Rating	1.5 W max
Leakage current	0.01 mA max
Internal consumption	10 mA max (NPN) 12 mA max (PNP)
On/off switching frequency	1000 Hz max
Encapsulation	IP67 (NEMA 6)
Temperature range	-10 °C to +70 °C
Indication	LED Red (NPN) LED Green (PNP)
Cable	Polyurethane

Reed Sensors

Reed type sensors are based on proven reed switch technology and provide reliable function in many applications. Simple installation and the available AC voltage range are advantages for this range of sensors.

Technical data

Design	Reed element
Installation	Mounts within cylinder switch Groove
Output	Normally open
Voltage range	5-120 V DC/AC
Voltage Drop	2.5 V max
Switching Current	100 mA max
Switch Rating	10 W max
Encapsulation	IP67 (NEMA 6)
Temperature range	-10 °C to +70 °C
Indication	LED Red
Cable	Polyurethane

Electronic sensors

Schematic

NPN type

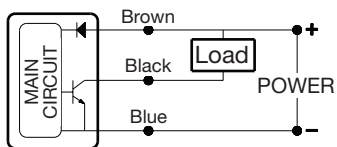

PNP type

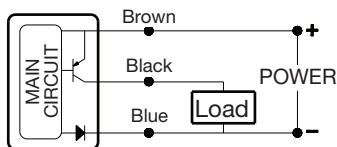

Dimensions

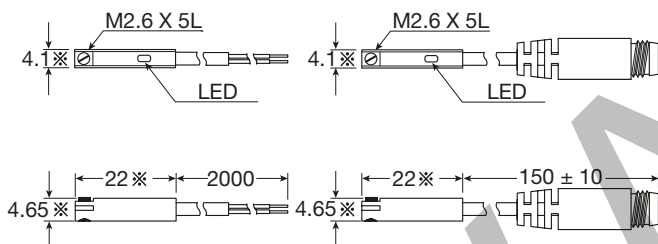

Reed sensors

Schematic

Reed type

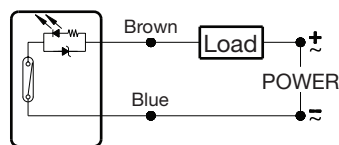

Dimensions

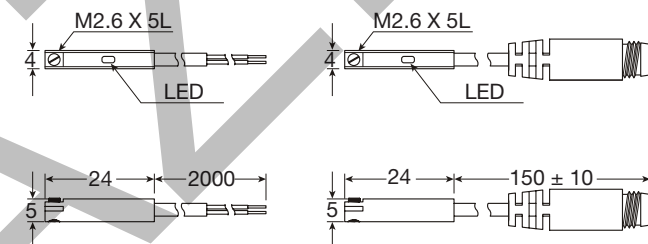

M8 Quick Connector

2 wire QC wiring

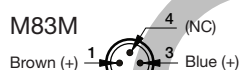

3 wire QC wiring



Electronic and Reed Sensors

Size	Description	Order Code
Flush Mount Style		
PNP Type, normally open	0.165 m cable and M8 screw male connector	P8S-EPSUS
PNP Type, normally open	2 m PUR cable without connector	P8S-EPFXS
NPN Type, normally open	0.165 m cable and M8 screw male connector	P8S-ENSUS
NPN Type, normally open	2 m PUR cable without connector	P8S-ENFXS
Reed Type, normally open	0.15 m cable and M8 screw male connector	P8S-ERSUS
Reed Type, normally open	2 m PUR cable without connector	P8S-ERFXS

Connecting cables with one connector

The cables have an integral snap-in female connector.



Type of cable	Cable/connector	Weight [kg]	Order Code
Cables for sensors, complete with one female connector			
Cable, Flex PVC	3 m, 8 mm Snap-in connector	0.07	9126344341
Cable, Flex PVC	10 m, 8 mm Snap-in connector	0.21	9126344342
Cable, Super Flex PVC	3 m, 8 mm Snap-in connector	0.07	9126344343
Cable, Super Flex PVC	10 m, 8 mm Snap-in connector	0.21	9126344344
Cable, Polyurethane	3 m, 8 mm Snap-in connector	0.01	9126344345
Cable, Polyurethane	10 m, 8 mm Snap-in connector	0.20	9126344346

Male connectors for connecting cables

Cable connectors for producing your own connecting cables. The connectors can be quickly attached to the cable without special tools. Only the outer sheath of the cable is removed. The connectors are available for M8 and M12 screw connectors and meet protection class IP 65.



Connector	Weight [kg]	Order Code
M8 Screw Connector	0.017	P8CS0803J
M12 Screw Connector	0.022	P8CS1204J

Technical data

Operating voltage	max. 32 V AC/DC
Operating current per contact	max. 4 A
Connection cross section	0.25... 0.5 mm ² (conductor diameter min 0.1 mm)
Protection	IP65 and IP67 when plugged and screwed down
Temperature range	-25... +85°C

Specifying air quality (purity) in accordance with ISO8573-1:2010, the international standard for Compressed Air Quality

ISO8573-1 is the primary document used from the ISO8573 series as it is this document which specifies the amount of contamination allowed in each cubic metre of compressed air.

ISO8573-1 lists the main contaminants as Solid Particulate, Water and Oil. The purity levels for each contaminant are shown separately in tabular form, however for ease of use, this document combines all three contaminants into one easy to use table.

ISO8573-1:2010 CLASS	Solid Particulate				Water		Oil
	Maximum number of particles per m ³			Mass Concentration mg/m ³	Vapour Pressure Dewpoint	Liquid g/m ³	Total Oil (aerosol liquid and vapour) mg/m ³
	0,1 - 0,5 micron	0,5 - 1 micron	1 - 5 micron				
0	As specified by the equipment user or supplier and more stringent than Class 1						
1	≤ 20 000	≤ 400	≤ 10	-	≤ -70 °C	-	0,01
2	≤ 400 000	≤ 6 000	≤ 100	-	≤ -40 °C	-	0,1
3	-	≤ 90 000	≤ 1 000	-	≤ -20 °C	-	1
4	-	-	≤ 10 000	-	≤ +3 °C	-	5
5	-	-	≤ 100 000	-	≤ +7 °C	-	-
6	-	-	-	≤ 5	≤ +10 °C	-	-
7	-	-	-	5 - 10	-	≤ 0,5	-
8	-	-	-	-	-	0,5 - 5	-
9	-	-	-	-	-	5 - 10	-
X	-	-	-	> 10	-	> 10	> 10

Specifying air purity in accordance with ISO8573-1:2010

When specifying the purity of air required, the standard must always be referenced, followed by the purity class selected for each contaminant (a different purity class can be selected for each contamination if required).

An example of how to write an air quality specification is shown below:

ISO 8573-1:2010 Class 1.2.1

ISO 8573-1:2010 refers to the standard document and its revision, the three digits refer to the purity classifications selected for solid particulate, water and total oil. Selecting an air purity class of 1.2.1 would specify the following air quality when operating at the standard's reference conditions :

Class 1 - Particulate

In each cubic metre of compressed air, the particulate count should not exceed 20,000 particles in the 0.1 - 0.5 micron size range, 400 particles in the 0.5 - 1 micron size range and 10 particles in the 1 - 5 micron size range.

Class 2 - Water

A pressure dewpoint (PDP) of -40°C or better is required and no liquid water is allowed.

Class 1 - Oil

In each cubic metre of compressed air, not more than 0.01mg of oil is allowed. This is a total level for liquid oil, oil aerosol and oil vapour.

ISO8573-1:2010 Class zero

- Class 0 does not mean zero contamination.
- Class 0 requires the user and the equipment manufacturer to agree contamination levels as part of a written specification.
- The agreed contamination levels for a Class 0 specification should be within the measurement capabilities of the test equipment and test methods shown in ISO8573 Pt 2 to Pt 9.
- The agreed Class 0 specification must be written on all documentation to be in accordance with the standard.
- Stating Class 0 without the agreed specification is meaningless and not in accordance with the standard.
- A number of compressor manufacturers claim that the delivered air from their oil-free compressors is in compliance with Class 0.
- If the compressor was tested in clean room conditions, the contamination detected at the outlet will be minimal. Should the same compressor now be installed in typical urban environment, the level of contamination will be dependent upon what is drawn into the compressor intake, rendering the Class 0 claim invalid.
- A compressor delivering air to Class 0 will still require purification equipment in both the compressor room and at the point of use for the Class 0 purity to be maintained at the application.
- Air for critical applications such as breathing, medical, food, etc typically only requires air quality to Class 2.2.1 or Class 2.1.1.
- Purification of air to meet a Class 0 specification is only cost effective if carried out at the point of use.

KOLVANZ.CZ

KOLVANZ.CZ

Parker Worldwide

Europe, Middle East, Africa

AE – United Arab Emirates, Dubai
Tel: +971 4 8127100
parker.me@parker.com

AT – Austria, Wiener Neustadt
Tel: +43 (0)2622 23501-0
parker.austria@parker.com

AT – Eastern Europe, Wiener Neustadt
Tel: +43 (0)2622 23501 900
parker.easteurope@parker.com

AZ – Azerbaijan, Baku
Tel: +994 50 2233 458
parker.azerbaijan@parker.com

BE/LU – Belgium, Nivelles
Tel: +32 (0)67 280 900
parker.belgium@parker.com

BG – Bulgaria, Sofia
Tel: +359 2 980 1344
parker.bulgaria@parker.com

BY – Belarus, Minsk
Tel: +48 (0)22 573 24 00
parker.poland@parker.com

CH – Switzerland, Etoy
Tel: +41 (0)21 821 87 00
parker.switzerland@parker.com

CZ – Czech Republic, Klecany
Tel: +420 284 083 111
parker.czechrepublic@parker.com

DE – Germany, Kaarst
Tel: +49 (0)2131 4016 0
parker.germany@parker.com

DK – Denmark, Ballerup
Tel: +45 43 56 04 00
parker.denmark@parker.com

ES – Spain, Madrid
Tel: +34 902 330 001
parker.spain@parker.com

FI – Finland, Vantaa
Tel: +358 (0)20 753 2500
parker.finland@parker.com

FR – France, Contamine s/Arve
Tel: +33 (0)4 50 25 80 25
parker.france@parker.com

GR – Greece, Athens
Tel: +30 210 933 6450
parker.greece@parker.com

HU – Hungary, Budaörs
Tel: +36 23 885 470
parker.hungary@parker.com

IE – Ireland, Dublin
Tel: +353 (0)1 466 6370
parker.ireland@parker.com

IT – Italy, Corsico (MI)
Tel: +39 02 45 19 21
parker.italy@parker.com

KZ – Kazakhstan, Almaty
Tel: +7 7273 561 000
parker.easteurope@parker.com

NL – The Netherlands, Oldenzaal
Tel: +31 (0)541 585 000
parker.nl@parker.com

NO – Norway, Asker
Tel: +47 66 75 34 00
parker.norway@parker.com

PL – Poland, Warsaw
Tel: +48 (0)22 573 24 00
parker.poland@parker.com

PT – Portugal, Leca da Palmeira
Tel: +351 22 999 7360
parker.portugal@parker.com

RO – Romania, Bucharest
Tel: +40 21 252 1382
parker.romania@parker.com

RU – Russia, Moscow
Tel: +7 495 645-2156
parker.russia@parker.com

SE – Sweden, Spånga
Tel: +46 (0)8 59 79 50 00
parker.sweden@parker.com

SK – Slovakia, Banská Bystrica
Tel: +421 484 162 252
parker.slovakia@parker.com

SL – Slovenia, Novo Mesto
Tel: +386 7 337 6650
parker.slovenia@parker.com

TR – Turkey, Istanbul
Tel: +90 216 4997081
parker.turkey@parker.com

UA – Ukraine, Kiev
Tel: +48 (0)22 573 24 00
parker.poland@parker.com

UK – United Kingdom, Warwick
Tel: +44 (0)1926 317 878
parker.uk@parker.com

ZA – South Africa, Kempton Park
Tel: +27 (0)11 961 0700
parker.southafrica@parker.com

North America

CA – Canada, Milton, Ontario
Tel: +1 905 693 3000

US – USA, Cleveland
Tel: +1 216 896 3000

Asia Pacific

AU – Australia, Castle Hill
Tel: +61 (0)2-9634 7777

CN – China, Shanghai
Tel: +86 21 2899 5000

HK – Hong Kong
Tel: +852 2428 8008

IN – India, Mumbai
Tel: +91 22 6513 7081-85

JP – Japan, Tokyo
Tel: +81 (0)3 6408 3901

KR – South Korea, Seoul
Tel: +82 2 559 0400

MY – Malaysia, Shah Alam
Tel: +60 3 7849 0800

NZ – New Zealand, Mt Wellington
Tel: +64 9 574 1744

SG – Singapore
Tel: +65 6887 6300

TH – Thailand, Bangkok
Tel: +662 186 7000

TW – Taiwan, Taipei
Tel: +886 2 2298 8987

South America

AR – Argentina, Buenos Aires
Tel: +54 3327 44 4129

BR – Brazil, Sao Jose dos Campos
Tel: +55 800 727 5374

CL – Chile, Santiago
Tel: +56 2 623 1216

MX – Mexico, Toluca
Tel: +52 72 2275 4200

European Product Information Centre

Free phone: 00 800 27 27 5374

(from AT, BE, CH, CZ, DE, DK, EE, ES, FI, FR, IE, IL, IS, IT, LU, MT, NL, NO, PL, PT, RU, SE, SK, UK, ZA)

Parker Hannifin Ltd.

Tachbrook Park Drive
Tachbrook Park,
Warwick, CV34 6TU
United Kingdom
Tel.: +44 (0) 1926 317 878
Fax: +44 (0) 1926 317 855
parker.uk@parker.com
www.parker.com

