



LIQUIfit® Push-in Fittings / Stud Fittings



Innovative and compact connectors for the transfer of fluids and liquids.

Ø metric: 4 to 16 mm
Ø inch: 1/4" to 1/2"

Technical Characteristics

- **Compatible Fluids:** Water, beverages, CO₂ (inert use)
Chemical fluids: please consult us
- **Working Pressure:** Vacuum to 16 bar
- **Working Temperature:**
-10°C to +95°C
-20° to +70°C for 16 mm to 10 bar

Tightening Torques (BSPT/NPTF)	Thread	1/8" and 1/4"	3/8" and 1/2"
	daN.m		0.15

Reliable performance is dependent upon the type of fluid conveyed, component materials and tubing being used.

Use is guaranteed with a vacuum of 755 mm Hg (99% vacuum).

Advantages

- Bio-sourced polymer meeting food process regulations
- Compliant with FDA, NSF, DM174, KTW, ACS standards
- Easy-to-clean external surfaces
- Free of bisphenol and phthalates

Component Materials

Silicone-free

Grey release button: technical polymer

Body and adaptor: bio-based polymer

Seal: EPDM

Gripping ring or collet (6501 and 6599): stainless steel

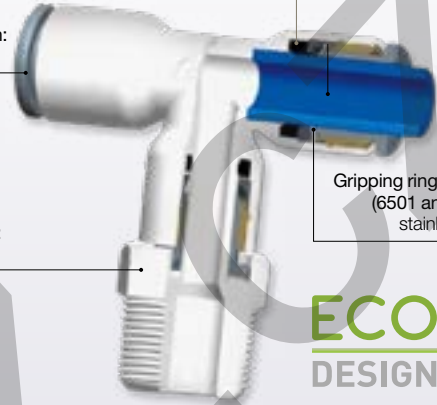

Regulations

- RoHS
- REACH
- FDA: 21 CFR
- NSF: 51
- NSF 61 - C HOT
- 1935/2004
- DM 174
- ACS
- KTW

Pressure and Temperature of the Different Diameters and Related Products of the LIQUIfit® Range

-10°C		Pressure (bar)		+1°C		Pressure (bar)		+20°C		Pressure (bar)	
mm Ø	inch Ø	Fittings	PE Tubing	mm Ø	inch Ø	Fittings	PE Tubing	mm Ø	inch Ø	Fittings	PE Tubing
4	5/32	16	16	4	5/32	16	16	4	5/32	16	16
6	1/4	16	16	6	1/4	16	16	6	1/4	16	16
8	5/16	16	16	8	5/16	16	16	8	5/16	16	16
10	3/8	13	15	10	3/8	13	15	10	3/8	13	15
12	1/2	11	11	12	1/2	11	11	12	1/2	11	11

+40°C		Pressure (bar)		+65°C		Pressure (bar)		+95°C		Pressure (bar)	
mm Ø	inch Ø	Fittings	PE Tubing	mm Ø	inch Ø	Fittings	PE Tubing	mm Ø	inch Ø	Fittings	PE Tubing
4	5/32	16	16	4	5/32	12	10	4	5/32	12	4
6	1/4	16	16	6	1/4	12	10	6	1/4	12	4
8	5/16	16	16	8	5/16	12	10	8	5/16	12	4
10	3/8	13	15	10	3/8	7	7	10	3/8	4	4
12	1/2	11	11	12	1/2	7	7	12	1/2	4	4

6501 Stud Fitting, Male BSPP Thread

POM, EPDM



ØD	C		E	F	G	H	Kg
6	G1/8	6501 06 10WP2	6	15	18	18	0.003
	G1/4	6501 06 13WP2	8.5	18	18	15.5	0.004
8	G1/8	6501 08 10WP2	6	17	18	18.5	0.005
	G1/4	6501 08 13WP2	8.5	18	18	20	0.006
	G3/8	6501 08 17WP2	6	21	20	17.5	0.007
10	G1/4	6501 10 13WP2	8.5	19	20	22	0.007
	G3/8	6501 10 17WP2	9	21	20	17	0.007
12	G1/2	6501 10 21WP2	12.5	26	21.5	17	0.011
	G3/8	6501 12 17WP2	9	24	21.5	25	0.011
	G1/2	6501 12 21WP2	12.5	26	21.5	20	0.012

Collet technology
NSF certified fitting only

6505 Stud Fitting, Male BSPT Thread

Bio-based polymer, EPDM

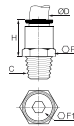

ØD	C		F	F1	H	Kg
4	R1/8	6505 04 10WP2	11	3	18	0.003
	R1/4	6505 04 13WP2	14	3	18	0.004
6	R1/8	6505 06 10WP2	11	4	18	0.002
	R1/4	6505 06 13WP2	14	4	18	0.004
8	R1/8	6505 08 10WP2	17	6	20	0.004
	R1/4	6505 08 13WP2	14	6	20	0.004
	R3/8	6505 08 17WP2	17	6	20	0.005
10	R1/4	6505 10 13WP2	17	7	21.5	0.005
	R3/8	6505 10 17WP2	19	7	21.5	0.007
12	R1/2	6505 10 21WP2	22	7	21.5	0.010
	R3/8	6505 12 17WP2	19	9	24.5	0.008
	R1/2	6505 12 21WP2	22	9	24.5	0.012

6505 Stud Fitting, Male NPTF Thread

Inch

Bio-based polymer, EPDM

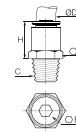

ØD	C		F	F1	H	Kg
1/4	NPT1/8	6505 56 11WP2	1/2	5/32	17	0.002
	NPT1/4	6505 56 14WP2	9/16	5/32	17	0.003
3/8	NPT1/4	6505 60 14WP2	3/4	1/4	22	0.006
	NPT3/8	6505 60 18WP2	3/4	1/4	22	0.007
1/2	NPT3/8	6505 62 18WP2	15/16	3/8	28	0.012
	NPT1/2	6505 62 22WP2	15/16	3/8	28	0.013

Thread without pre-coating

6505 Stud Fitting, Male BSPT Thread

Inch

Bio-based polymer, EPDM

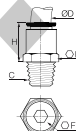

ØD	C		F	F1	H	Kg
1/4	R1/8	6505 56 10WP2	11	5	17	0.002
	R1/4	6505 56 13WP2	14	5	17	0.003
3/8	R3/8	6505 60 17WP2	19	7	22	0.006
	R1/2	6505 60 21WP2	22	7	28	0.012
1/2	R1/2	6505 62 21WP2	24	9	28	0.017

5/32" (4mm) and 5/16" (8mm) are available
Thread without pre-coating

6315 Stud Connector, Female BSPT Thread

Bio-based polymer, EPDM

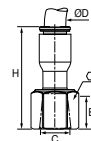

ØD	C		E	F	H	Kg
6	R1/8	6315 06 10WP2	11	13	32	0.003
	R1/4	6315 06 13WP2	14	16	33	0.004
8	R1/4	6315 08 13WP2	14	16	33.5	0.004
	R3/8	6315 08 17WP2	14	20	36	0.009

WP3 = high volumes (number of parts per bag: 40, 50 or 100, depending on the diameters).

6315 Stud Fitting, Female NPTF Thread

Inch

Bio-based polymer, EPDM

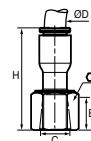

ØD	C		F	H	Kg
1/4	NPT1/4	6315 56 14WP2	11/16	30	0.003
3/8	NPT3/8	6315 60 18WP2	13/16	36	0.007

6352 Stud Fitting Flat Type, Female BSPP Thread Inch

Bio-based polymer, EPDM

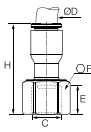

ØD	C		E	F	H	Kg
3/8	G3/8	6352 60 17WP2	12	22	36	0.008
	G1/2	6352 60 21WP2	12	27	36	0.011

6325 Faucet Connector, Female UNS Thread Inch

Bio-based polymer, EPDM

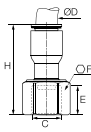

ØD	C		E	F	H	Kg
1/4	UNS7/16-24	6325 56 133WP2	7	9/16	31	0.002

6521 Stud Standpipe, Male BSPT Thread

Bio-based polymer

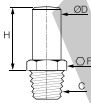

ØD	C		F	H	Kg
6	R1/8	6521 06 10WP2	13	19	0.002
	R1/4	6521 06 13WP2	14	19	0.003
	R3/8	6521 06 17WP2	17	19	0.004
8	R1/8	6521 08 10WP2	19	23	0.003
	R1/4	6521 08 13WP2	19	23	0.004
	R3/8	6521 08 17WP2	19	23	0.004
10	R1/4	6521 10 13WP2	19	25	0.004
	R3/8	6521 10 17WP2	19	25	0.005
	R1/2	6521 10 21WP2	22	25	0.008
12	R3/8	6521 12 17WP2	22	28	0.005
	R1/2	6521 12 21WP2	22	28	0.007

Thread without pre-coating.

6521 Stud Standpipe, Male NPTF Thread Inch

Bio-based polymer

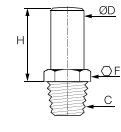

ØD	C		F	H	Kg
3/8	NPT1/4	6521 60 14WP2	3/4	25	0.004
	NPT3/8	6521 60 18WP2	3/4	25	0.004

Thread without pre-coating.

6521 Stud Standpipe, Male BSPT Thread Inch

Bio-based polymer

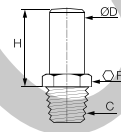

ØD	C		F	H	Kg
1/4	R1/8	6521 56 10WP2	14	19	0.002
	R1/4	6521 56 13WP2	14	19	0.002
	R3/8	6521 56 17WP2	17	19	0.004
3/8	R3/8	6521 60 17WP2	19	25	0.004

Thread without pre-coating.
5/16" (8mm) also available.

6300 LIQUIfit® Cartridge

Brass, EPDM

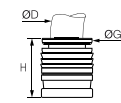

ØD		G	G1	H	L	Kg
4	6300 04 00	8	11	10	554	0.002
6	6300 06 00	10	14.5	11.5	629	0.002
8	6300 08 00	13	15	15	794	0.003
10	6300 10 00	15.5	19.5	17	930	0.005
12	6300 12 00	18.5	21	19.5	1038	0.010

50 cartridges per Carstick®

Please consult us for detailed drawings of cavity dimensions and tolerances

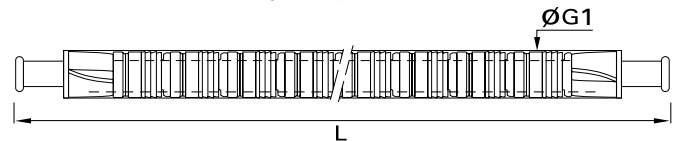

Sealing Profile for Female Thread Stud Fitting

Stud Fitting,
Female NPTF Thread
6315

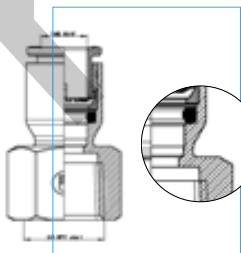

Stud Fitting Flat Type,
Female BSPP Thread,
6352

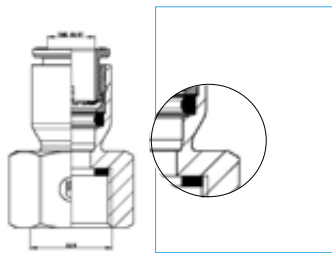

6300 Carstick+ Cartridge EPDM



ØD		G	G1	H	L	kg
4	6300 04 01 24	8.1	10.3	10.4	520	0.001
6	6300 06 01 24	9.9	15.3	11.8	590	0.002

6300 Carstick+ Cartridge FKM



ØD		G	G1	H	L	kg
4	6300 04 01 26	8.1	10.3	10.4	520	0.001
6	6300 06 01 26	9.9	15.3	11.8	590	0.002

6300 LIQUIfit® Cartridge

Inch

Brass, EPDM

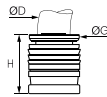

ØD		G	G1	H	L	Kg
1/4	6300 56 00	10.5	14.5	12.5	600	0.002
3/8	6300 60 00	15.5	19	17	930	0.005
1/2	6300 62 00	22	25	23	1038	0.011

50 cartridges per Carstick®
5/32" (4 mm) and 5/16" (8 mm) also available.
Please consult us for detailed drawings of cavity dimensions and tolerances

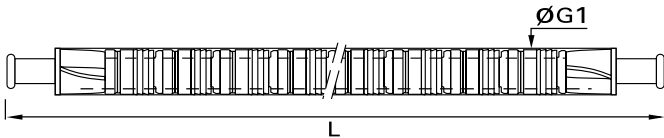

6579 Fixed Elbow, Male BSPT Thread

Bio-based polymer, EPDM

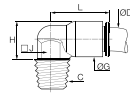

ØD	C		G	H	J	L	Kg
6	R1/8	6579 06 10WP2	11	14	10	19	0.002
	R1/4	6579 06 13WP2	11	14	10	19	0.003
	R3/8	6579 06 17WP2	11	14	10	19	0.004

Thread without pre-coating.

6579 Fixed Elbow, Male NPTF Thread

Inch

Bio-based polymer, EPDM

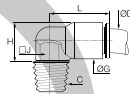

ØD	C		G	H	J	L	Kg
1/4	NPT1/8	6579 56 11WP2	11	22	38	18	0.009
	NPT1/4	6579 56 14WP2	11	26	38	18	0.003
3/8	NPT1/4	6579 60 14WP2	16	32	12	26	0.006

Thread without pre-coating.

6579 Fixed Elbow, Male BSPT Thread

Inch

Bio-based polymer, EPDM

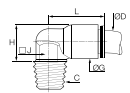

ØD	C		G	H	J	L	Kg
1/4	R1/4	6579 56 13WP2	11	26	10	18	0.003
3/8	R3/8	6579 60 17WP2	16	32	13	26	0.006

Thread without pre-coating.

6599 Stud Elbow, Male BSPP Thread

POM, EPDM



ØD	C		E	F	G	H	Kg
6	G1/8	6599 06 10WP2	6	17	15	24.5	0.007
	G1/4	6599 06 13WP2	8.5	18	15	33	0.008
	G1/8	6599 08 10WP2	6	18	17.5	26	0.010
8	G1/4	6599 08 13WP2	8.5	18	17.5	26	0.011
	G3/8	6599 08 17WP2	9	22	17.5	26	0.012
10	G1/4	6599 10 13WP2	8.5	22	20	29.5	0.015
	G3/8	6599 10 17WP2	9	22	20	29.5	0.015
12	G1/2	6599 10 21WP2	12.5	26	20	29.5	0.019
	G3/8	6599 12 17WP2	9	26	23	34.5	0.023
	G1/2	6599 12 21WP2	12.5	26	23	34.5	0.025

Collet technology
Thread without pre-coating; the body swivels for positioning purposes.
NSF certified fitting only

6509 Stud Elbow, Male BSPT Thread

Bio-based polymer, EPDM

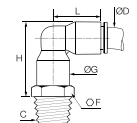

ØD	C		F	G	H	L	Kg
6	R1/8	6509 06 10WP2	13	10.5	28	24	0.037
	R1/4	6509 06 13WP2	14	10.5	28	24	0.007
	R3/8	6509 06 17WP2	17	10.5	28	24	0.008
8	R1/8	6509 08 10WP2	19	13.5	34	29.5	0.010
	R1/4	6509 08 13WP2	19	13.5	34	29.5	0.011
10	R3/8	6509 08 17WP2	19	13.5	34	29.5	0.011
	R1/4	6509 10 13WP2	19	16	38	34.5	0.019
12	R3/8	6509 10 17WP2	19	16	38	34.5	0.020
	R1/2	6509 10 21WP2	22	16	38	34.5	0.023
12	R3/8	6509 12 17WP2	22	19	44	40	0.022
	R1/2	6509 12 21WP2	22	19	44	40	0.024

Thread without pre-coating; the body swivels for positioning purposes.

6509 Stud Elbow, Male NPTF Thread

Inch

Bio-based polymer, EPDM

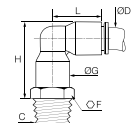

ØD	C		F	G	H	L	Kg
1/4	NPT1/8	6509 56 11WP2	1/2	11	28	23.5	0.003
	NPT1/4	6509 56 14WP2	9/16	11	28	23.5	0.004
	NPT3/8	6509 56 18WP2	3/4	11	28.5	23.5	0.006

Thread without pre-coating; the body swivels for positioning purposes.

6509 Stud Elbow, Male BSPT Thread

Inch

Bio-based polymer, EPDM

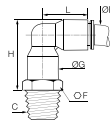

ØD	C		F	G	H	L	Kg
1/2	R1/2	6509 62 21WP2	24	22	50.5	46.5	0.027

5/16" (8 mm) also available.

Thread without pre-coating, the body swivels for positioning purposes.

6508 Branch Tee, Male BSPT Thread

Bio-based polymer, EPDM

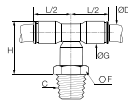

ØD	C		F	G	H	L/2	Kg
6	R1/8	6508 06 10WP2	13	10.5	28	18	0.008
	R1/4	6508 06 13WP2	14	10.5	28	18	0.009
	R3/8	6508 06 17WP2	17	10.5	28	18	0.010
8	R1/8	6508 08 10WP2	19	13.5	34	23	0.012
	R1/4	6508 08 13WP2	19	13.5	34	23	0.013
	R3/8	6508 08 17WP2	19	13.5	34	23	0.013
10	R1/4	6508 10 13WP2	19	16	38	26.5	0.018
	R3/8	6508 10 17WP2	19	16	38	26.5	0.019
	R1/2	6508 10 21WP2	22	16	38	26.5	0.022
12	R1/2	6508 12 21WP2	22	19	44	31	0.026

Thread without pre-coating, the body swivels for positioning purposes.

6503 Run Tee, Male BSPT Thread

Bio-based polymer, EPDM

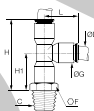

ØD	C		F	G	H	H1	L	Kg
6	R1/4	6503 06 13WP2	14	10.5	40	22	18.5	0.009
	R1/8	6503 08 10WP2	19	13.5	50	27	23	0.012
8	R1/4	6503 08 13WP2	19	13.5	50	27	23	0.013
	R3/8	6503 08 17WP2	19	13.5	50	27	23	0.013
12	R3/8	6503 12 17WP2	22	19	65.5	34.5	31	0.024
	R1/2	6503 12 21WP2	22	19	65.5	34.5	31	0.026

Thread without pre-coating, the body swivels for positioning purposes.

6355 Unequal Connector, Female BSPP Thread

Bio-based polymer, EPDM

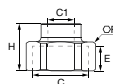

C	C1		E	F	H	Kg
G3/4	G1/4	6355 13 27WP2	10	32	23.5	0.050

6306 Equal and Unequal Tube-to-Tube Connector

Bio-based polymer, EPDM

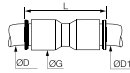

ØD	ØD1		G	G1	L	Kg
4	4	6306 04 00WP2		8.5	26.5	0.002
	6	6306 04 06WP2		10.5	29	0.002
	8	6306 04 08WP2		13.5	37	0.005
6	6	6306 06 00WP2		10.5	30	0.004
	8	6306 06 08WP2	10.6	13.5	34,1	0.005
	10	6306 06 10WP2		16	42	0.007
8	8	6306 08 00WP2		13.5	37	0.004
	10	6306 08 10WP2		16	42	0.007
	12	6306 08 12WP2		19	50	0.012
10	10	6306 10 00WP2		16	42	0.009
	12	6306 10 12WP2		19	50	0.013
12	12	6306 12 00WP2		19	50.5	0.009
16	16	6306 16 00		27	60.5	0.023

6302 Equal and Unequal Union Elbow

Inch

Bio-based polymer, EPDM

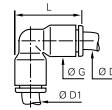

ØD	ØD1		G	L	Kg
5/16	3/8	6302 08 60WP2	16	34	0.009
	1/4	6302 56 00WP2	11	24	0.005
1/4	5/16	6302 56 08WP2	13.5	29.5	0.006
	3/8	6302 56 60WP2	16	34	0.008
3/8	3/8	6302 60 00WP2	16	34	0.006
	1/2	6302 60 62WP2	22	46.5	0.011
1/2	1/2	6302 62 00WP2	22	46.5	0.017

6306 Equal and Unequal Union Connector

Inch

Bio-based polymer, EPDM

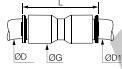

ØD	ØD1		G	L	Kg
5/16	3/8	6306 08 60WP2	16	42	0.008
	1/2	6306 08 62WP2	22	55	0.018
1/4	1/4	6306 56 00WP2	11	30	0.004
	3/8	6306 56 60WP2	16	41	0.007
3/8	3/8	6306 60 00WP2	16	42	0.006
	1/2	6306 60 62WP2	22	56	0.020
1/2	1/2	6306 62 00WP2	22	57	0.016

6304 Union Tee

Bio-based polymer, EPDM

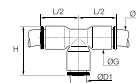

ØD	ØD1		G	H	L/2	Kg
4	4	6304 04 00WP2	8.5	20	15.5	0.004
6	6	6304 06 00WP2	10.5	23	18	0.006
8	8	6304 08 00WP2	13.5	29	22.5	0.006
10	10	6304 10 00WP2	16	34.5	26.5	0.009
12	12	6304 12 00WP2	19	40	31	0.014
16	16	6304 16 00	27	53	39	0.037
	12	6304 16 12	27	53	39	0.063

6302 Equal and Unequal Elbow

Bio-based polymer, EPDM

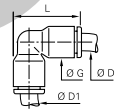

ØD	ØD1		G	L	Kg
4	4	6302 04 00WP2	8.5	19	0.002
	6	6302 04 06WP2	10.5	24	0.004
6	6	6302 06 00WP2	10.5	24	0.004
	8	6302 06 08WP2	13.5	29.5	0.006
8	8	6302 08 00WP2	13.5	29	0.004
	10	6302 08 10WP2	16	34.5	0.008
10	10	6302 10 00WP2	16	34.5	0.005
	12	6302 10 12WP2	19	40.5	0.013
12	12	6302 12 00WP2	19	40.5	0.010
16	16	6302 16 00	27	53	0.024

6304 Equal and Unequal Union Tee

Inch

Bio-based polymer, EPDM

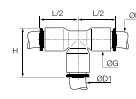

ØD	ØD1		G	H	L/2	Kg
1/4	1/4	6304 56 00WP2	11	24	18	0.002
3/8	3/8	6304 60 00WP2	16	34	26	0.009
	1/4	6304 60 56WP2	16	34	26	0.011
1/2	1/2	6304 62 00WP2	22	47	36	0.027
	3/8	6304 62 60WP2	22	47	36	0.009

5/32" (4mm) and 5/16" (8mm) also available

6340 Equal Single Y Piece

Bio-based polymer, EPDM

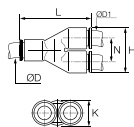

ØD	ØD1		H	K	L	N	Kg
4	4	6340 04 00WP2	17.5	8.5	30	9	0.004
6	6	6340 06 00WP2	21.5	10.5	36.5	11	0.008
8	8	6340 08 00WP2	28	13.5	44.5	14.5	0.007
10	10	6340 10 00WP2	33	16	53	17	0.010
12	12	6340 12 00WP2	39	19	60.5	20	0.025

6340 Equal Single Y Piece

Inch

Bio-based polymer, EPDM

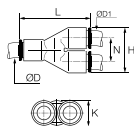

ØD	ØD1		H	K	L	N	Kg
1/4	1/4	6340 56 00WP2	22	11	36	11.5	0.010
3/8	3/8	6340 60 00WP2	33	16	53	17	0.011
1/2	1/2	6340 62 00WP2	45	22	67	23	0.028

5/32" (4 mm) and 5/16" (8 mm) also available.

6307 Equal Cross

Bio-based polymer, EPDM

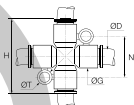

ØD		G	H	N	ØT	Kg
6	6307 06 00WP2	11	36	20	4.2	0.005
8	6307 08 00WP2	13.5	45	22.5	4.2	0.020

6307 Equal Cross

Inch

Bio-based polymer, EPDM

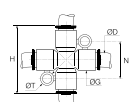

ØD		G	H	L	ØT	Kg
1/4	6307 56 00WP2	11	36	20	4.2	0.010

5/16" (8 mm) also available

6316 Equal Bulkhead Union

Bio-based polymer, EPDM

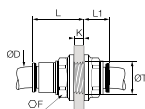

ØD		F	K max	L	L1	ØT min	Kg
4	6316 04 00WP2	13	5.5	15.5	10.5	10.5	0.018
6	6316 06 00WP2	15	8.5	20	10	12.5	0.004
8	6316 08 00WP2	18	14.5	27	10.5	15.5	0.007
10	6316 10 00WP2	22	14.5	30	13	18.5	0.012
12	6316 12 00WP2	26	18.5	35	15.5	22.5	0.020

6316 Bulkhead Union

Inch

Bio-based polymer, EPDM

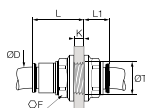

ØD		F	K max	L	L1	ØT min	Kg
1/4	6316 56 00WP2	15	8.5	20	10	12.5	0.004
3/8	6316 60 00WP2	22	14.5	29.5	12.5	18.5	0.012
1/2	6316 62 00WP2	29	20.5	40.5	17	25.5	0.030

5/32" (4mm) and 5/16" (8mm) also available

6976 Bulkhead Union

Stainless steel 316L, EPDM

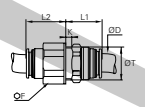

ØD		F	K max	L1	L2	ØT min	Kg
16	6976 16 00	32	10.5	33	30	27.5	0.166

Electrical protection class IP55

Complementary LIQUIfit® Range Products

The other LIQUIfit® range products are presented in the corresponding chapters of this catalogue:

Technical Tubing and Hose

Advanced PE



Function Fittings

Non-Return Valves



Industrial Ball Valves

LIQUIfit® Ball Valves



6382 Equal and Unequal Plug-In Elbow

Bio-based polymer, EPDM

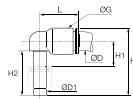

ØD	ØD1		G	H	H1	H2	L	Kg
4	4	6382 04 00WP2	8.5	23	6	15.5	15	0.003
	6	6382 04 06WP2	10.5	26.5	7	17	16.5	0.002
	6	6382 06 00WP2	10.5	26.5	7	17	17	0.003
6	4	6382 06 04WP2	10.5	25	7	15.5	17	0.001
	8	6382 06 08WP2	13.5	33.5	8	21.5	22.5	0.004
8	8	6382 08 00WP2	13.5	33.5	8	21.5	22.5	0.004
	10	6382 08 10WP2	16	39	9.5	24.5	26	0.007
10	10	6382 10 00WP2	16	39	9.5	24.5	26.5	0.004
	12	6382 10 12WP2	19	44.5	10	27	30	0.011
12	12	6382 12 00WP2	19	44.5	10	27	31	0.012

The references in diameter 4mm and 12mm are not grooved in standard version

6383 Plug-In Equal Run Tee

Bio-based polymer, EPDM

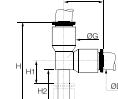

ØD	ØD1		G	H	H1	H2	L	Kg
4	4	6383 04 00WP2	8.5	33	6	15.5	15	0.002
6	6	6383 06 00WP2	10.5	38.5	7	17	18	0.002
8	8	6383 08 00WP2	13.5	49	8	21.5	23	0.005
10	10	6383 10 00WP2	16	57	10.5	25.5	26.5	0.012

6382 Equal and Unequal Plug-In Elbow

Inch

Bio-based polymer, EPDM

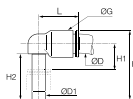

ØD	ØD1		G	H	H1	H2	L	Kg
5/16	3/8	6382 08 60WP2	16	39	10	24.5	26	0.009
1/4	1/4	6382 56 00WP2	11	30.5	11	18	18	0.002
	3/8	6382 56 60WP2	16	39	9	24.5	25.5	0.006
3/8	3/8	6382 60 00WP2	16	39	9	24.5	26.5	0.005
1/2	1/2	6382 62 00WP2	22	49	13	28.5	36	0.004

Equal plug-in elbow: 5/32" (4 mm) and 5/16" (8 mm) also available
The references in diameter 4mm and 12mm are not grooved in standard version

6388 Plug-In Equal Branch Tee

Bio-based polymer, EPDM

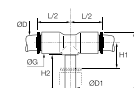

ØD	ØD1		G	H	H1	H2	L/2	Kg
4	4	6388 04 00WP2	8.5	25	6	15.5	15	0.005
6	6	6388 06 00WP2	10.5	28.5	7	17	16	0.006
8	8	6388 08 00WP2	13.5	33.5	8	21.5	23	0.005
10	10	6388 10 00WP2	16	41	9.5	24.5	26.5	0.007

6380 Plug-In 45° Equal Elbow

Bio-based polymer, EPDM

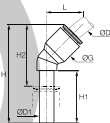

ØD	ØD1		G	H	H1	H2	L	Kg
4	4	6380 04 00WP2	8.5	33.5	19	21	13	0.001
6	6	6380 06 00WP2	11	39	21	25	14.5	0.002
8	8	6380 08 00WP2	13.5	44	21.5	25.5	19.5	0.006
10	10	6380 10 00WP2	16	53	27	32.5	23	0.004
12	12	6380 12 00WP2	19	58	27	34	26	0.012

6388 Plug-In Branch Tee

Inch

Bio-based polymer, EPDM

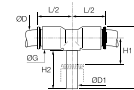

ØD	ØD1		G	H	H1	H2	L/2	Kg
1/4	1/4	6388 56 00WP2	11	30.5	11	20	18	0.002
3/8	3/8	6388 60 00WP2	16	42	12	25	25	0.008

5/32" (4 mm) and 5/16" (8 mm) also available.
For rotary applications, we recommend the use of a special grooved version, available upon request.

6366 Plug-In Reducer

Bio-based polymer, EPDM

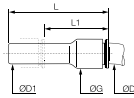

ØD	ØD1		G	L	L1	Kg
4	6	6366 04 06WP2	8.5	38	23.5	0.004
	8	6366 04 08WP2	8.5	38	19	0.004
6	8	6366 06 08WP2	10.5	38	20	0.004
	10	6366 06 10WP2	10.5	39	17.5	0.002
8	10	6366 08 10WP2	13.5	48.5	28.5	0.009
	12	6366 08 12WP2	13.5	48.5	24.5	0.004
10	12	6366 10 12WP2	16	52	33.5	0.005
	14	6366 10 14WP2	16	53	33.5	0.005

6366 Plug-In Reducer

Inch

Bio-based polymer, EPDM

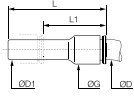

ØD	ØD1		G	L	L1	Kg
1/4	5/16	6366 56 08WP2	11	41	22.5	0.015
	3/8	6366 56 60WP2	11	41	20.5	0.002
5/16	3/8	6366 08 60WP2	13.5	48.5	29	0.003
	1/2	6366 08 62WP2	16	48.5	22	0.007
3/8	1/2	6366 60 62WP2	16	51	30	0.011

6368 Plug-In Increaser

Inch

Bio-based polymer, EPDM

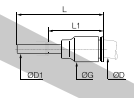

ØD	ØD1		G	L	L1	Kg
3/8	5/16	6368 60 08WP2	16	44	25.5	0.004

6326 Blanking Plug

Bio-based polymer

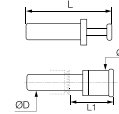

ØD		G	L	L1	Kg
4	6326 04 00WP2	6	30	15.5	0.002
6	6326 06 00WP2	8	33	16.5	0.002
8	6326 08 00WP2	10	35	17.5	0.002
10	6326 10 00WP2	12	42	21	0.003
12	6326 12 00WP2	14	45	22	0.004

6326 Blanking Plug

Inch

Bio-based polymer

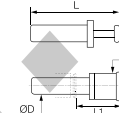

ØD		G	L	L1	Kg
1/4	6326 56 00WP2	8	36.5	22	0.002
3/8	6326 60 00WP2	11.6	42.5	22	0.002
1/2	6326 62 00WP2	14.7	48.5	21.5	0.004

5/32" (4 mm) and 5/16" (8 mm) also available

6322 Plug-In Barb Connector

Bio-based polymer

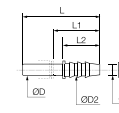

ØD	ØD1		L	L1	L2	Kg
6	4	6322 06 04WP2	39	25	17	0.004
8	5.75	6322 08 06WP2	43	25	17	0.005
10	7	6322 10 07WP2	50	29.5	22	0.006
12	12.5	6322 12 62WP2	56	32	27.5	0.004

6322 Plug-In Barb Connector

Inch

Bio-based polymer

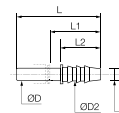

ØD	ØD1	ØD2		L	L1	L2	Kg
1/4	0.28	0.32	6322 56 56WP2	39	24.5	17	0.001
	0.33	0.38	6322 60 08WP2	50	29.5	22	0.002
3/8	0.28	0.32	6322 60 56WP2	45	24.5	17	0.008
	0.40	0.45	6322 60 60WP2	50	29	22	0.002
1/2	0.40	0.45	6322 62 60WP2	58	37.5	30	0.005

6351 End Cap

Bio-based polymer, EPDM



ØD		G	H	Kg
4	6351 04 00WP2	8.5	15	0.001
6	6351 06 00WP2	10.5	17	0.002
8	6351 08 00WP2	13.5	21.5	0.003
10	6351 10 00WP2	16	22	0.003
12	6351 12 00WP2	19	27.5	0.006

6351 End Cap

Inch

Bio-based polymer, EPDM



ØD		G	H	Kg
1/4	6351 56 00WP2	11	16	0.001
3/8	6351 60 00WP2	16	22.5	0.003

5/32" (4 mm) and 5/16" (8 mm) also available

6986 Blanking Plug

Stainless steel 316L

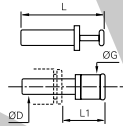

	6986 16 00			
--	-------------------	--	--	--

Up to +150°C