

LF 3600 Push-In Fittings / Stud Fittings



Made of chemical nickel-plated brass, this range of metal fittings is resistant to industrial and food fluids.

Ø metric:
4 to 14 mm

Technical Characteristics

- **Suitable Fluids:** compressed air, grease, lubricant, water...
- **Working Pressure:** vacuum to 30 bar (20 bar: 3699, 3609, 3639)
- **Working Temperature:** -25°C to +150°C

Maximum Tightening Torque (daN.m)	Threads							
	M5 x0.8	M6 x1	M8 x1	M10 x1	G1/8	G1/4	G3/8	G1/2
	0.16	0.18	0.6	0.8	0.8	1.2	3	3.5

Reliable performance is dependent upon the type of fluid conveyed, component materials and tubing being used.

Use is guaranteed with a vacuum of 755 mm Hg (99% vacuum).

Advantages

- Wide range of working temperatures: up to +150°C
- Wide range of working pressures: from vacuum up to 30 bar
- Materials conform to FDA standards
- Extended chemical compatibility

Component Materials

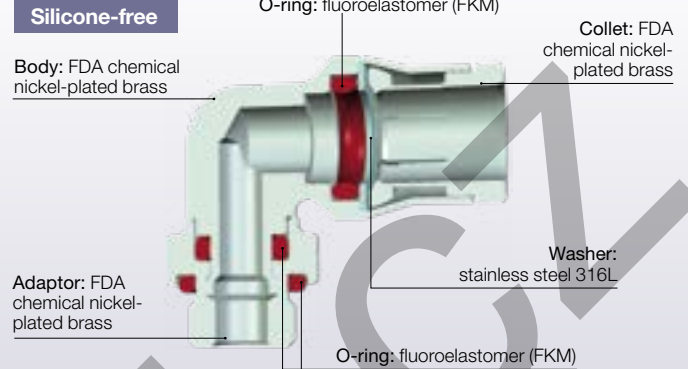

Regulations

- PED
- RoHS
- REACH

3675 Stud Fitting, Male BSPT Thread

FDA chemical Nickel-plated brass, FKM

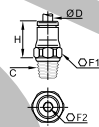

ØD	C		F1	F2	H	Kg
4	R1/8	3675 04 10	10	3	15	0.009
	R1/4	3675 04 13	14	3	15	0.017
6	R1/8	3675 06 10	13	4	17	0.011
	R1/4	3675 06 13	14	4	17	0.018
8	R1/8	3675 08 10	15	5	19	0.015
	R3/8	3675 08 17	17	6	18.5	0.027
10	R1/4	3675 10 13	18	7	23	0.026
	R3/8	3675 10 17	18	8	22.5	0.031
	R1/2	3675 10 21	22	8	22.5	0.056
12	R1/4	3675 12 13	20	7	25.5	0.033
	R3/8	3675 12 17	20	9	24	0.035
14	R1/2	3675 12 21	22	10	23	0.051
	R3/8	3675 14 17	22	9	27	0.042
	R1/2	3675 14 21	24	11	26	0.057

3601 Stud Fitting, Male BSPP and Metric Thread

FDA chemical Nickel-plated brass, FKM

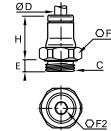

ØD	C		E	F1	F2	H	Kg
4	M5x0.8	3601 04 19	3,5	10	2,5	15,5	0,006
	M6x1	3601 04 52	4,5	10	3	16	0,006
	M8x1	3601 04 56	5	11	3	14,5	0,007
6	G1/8	3601 04 10	4,5	13	3	14,5	0,009
	G1/4	3601 04 13	5,5	16	3	14,5	0,015
8	M5x0.8	3601 06 19	3,5	13	2,5	19	0,010
	M10x1	3601 06 60	5,5	13	4	17,5	0,011
	G1/8	3601 06 10	4,5	13	4	17,5	0,011
10	G1/4	3601 06 13	5,5	16	4	17	0,015
	G1/8	3601 08 10	4,5	16	5	21	0,014
	G1/4	3601 08 13	5,5	16	6	18	0,016
12	G3/8	3601 08 17	5,5	20	6	19	0,028
	G1/4	3601 10 13	5,5	18	7	25	0,025
	G3/8	3601 10 17	5,5	20	8	22,5	0,028
14	G1/2	3601 10 21	7	24	8	22,5	0,043
	G1/4	3601 12 13	5,5	20	7	26,5	0,030
	G3/8	3601 12 17	5,5	20	9	26	0,034
16	G1/2	3601 12 21	7	24	10	23,5	0,042
	G3/8	3601 14 17	5,5	22	9	28	0,038
	G1/2	3601 14 21	7	24	11	26,5	0,045

LF 3600 Push-In Fittings / Stud Fittings

3681 Stud Fitting with Internal Hexagon, Male Metric Thread

FDA chemical Nickel-plated brass, FKM

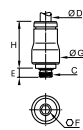

ØD	C	E	F	G	H	Kg
4	M5x0.8 3681 04 19	3.5	2.5	10	16	0.005

3614 Stud Fitting, Female BSPP and Metric Thread

FDA chemical Nickel-plated brass, FKM

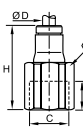

ØD	C	E	F	H	Kg
4	M5x0.8 3614 04 19	5	10	22	0.009
	G1/8 3614 04 10	7.5	14	25	0.016
	G1/4 3614 04 13	11	17	29	0.026
6	G1/8 3614 06 10	7.5	14	27.5	0.019
	G1/4 3614 06 13	11	17	31.5	0.028
8	G1/8 3614 08 10	9.5	15	28.5	0.022
	G1/4 3614 08 13	13.5	17	32.5	0.028
10	G3/8 3614 10 17	14	22	38	0.052
	G3/8 3614 12 17	14	22	39	0.055
12	G1/2 3614 12 21	18.5	24	43.5	0.062

3621 Stud Standpipe, Male BSPT Thread

FDA chemical Nickel-plated brass

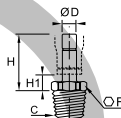

ØD	C	F	H	H1	Kg
4	R1/8 3621 04 10	10	21	7	0.006
	R1/8 3621 06 10	10	23.5	6.5	0.008
6	R1/4 3621 06 13	14	23.5	6.5	0.016
	R1/8 3621 08 10	10	24	6.5	0.009
8	R1/4 3621 08 13	14	24	6.5	0.017
	R1/4 3621 10 13	14	22	6.5	0.018
10	R3/8 3621 10 17	17	30	7.5	0.022
	R3/8 3621 12 17	17	31	7.5	0.023
12	R1/2 3621 12 21	22	31	7.5	0.041
14	R1/2 3621 14 21	22	33	8	0.042

3631 Stud Standpipe, Male BSPP and Metric Thread

FDA chemical Nickel-plated brass, FKM

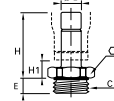

ØD	C	E	F	H	H1	Kg
4	M5x0.8 3631 04 19	3.5	13	21.5	7	0.003
	G1/8 3631 04 10	4.5	13	20	7	0.007
	G1/4 3631 04 13	5.5	8	20	7.5	0.011
6	G1/8 3631 06 10	4.5	13	22.5	6.5	0.009
	G1/4 3631 06 13	5.5	16	22.5	6.5	0.012
8	G1/8 3631 08 10	4.5	13	22.5	6.5	0.010
	G1/4 3631 08 13	5.5	16	23	6.5	0.013
10	G3/8 3631 08 17	5.5	20	23	7.5	0.018
	G1/4 3631 10 13	5.5	16	28	6.5	0.015
10	G3/8 3631 10 17	5.5	20	28	7.5	0.022
	G1/2 3631 10 21	7	24	28	7.5	0.028
12	G3/8 3631 12 17	5.5	20	29	7.5	0.023
	G1/2 3631 12 21	7	24	29	7.5	0.033
14	G1/2 3631 14 21	7	24	31	8	0.033

3600 Cartridge

FDA chemical Nickel-plated brass, FKM

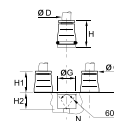

ØD	G	G1	H	H1	H2	N	Kg	
4	3600 04 00	9.8	8	17	8.5	8.5	11	0.006
6	3600 06 00	12.1	10	19	10.5	8.5	13.5	0.009
8	3600 08 00	14.8	13	21	12.5	8.5	16	0.012
10	3600 10 00	17.5	15	24.5	14	10.5	20	0.019
12	3600 12 00	20	17	25	14.5	10.5	22.5	0.023
14	3600 14 00	22	20	28.5	16.5	12	25	0.031

Cavity dimension available upon request

3609 Stud Elbow, Male BSPT Thread

FDA chemical Nickel-plated brass, FKM

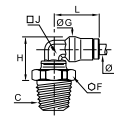

ØD	C	F	G	H	J	L	Kg
4	R1/8 3609 04 10	13	10	15	7	18	0.014
	R1/4 3609 04 13	14	10	17	7	18	0.020
6	R1/8 3609 06 10	13	12	17.5	8	21.5	0.018
	R1/4 3609 06 13	14	12	19	8	21.5	0.025
8	R1/8 3609 08 10	13	15	19.5	10	23.5	0.022
	R1/4 3609 08 13	14	15	21	10	23.5	0.029
10	R3/8 3609 08 17	17	15	21	10	23.5	0.035
	R1/4 3609 10 13	15	17.5	23.5	12	29	0.037
10	R3/8 3609 10 17	17	17.5	25.5	12	29	0.043
	R1/4 3609 12 13	15	19.5	26	15	31	0.049
12	R3/8 3609 12 17	17	19.5	28.5	15	31	0.055
	R1/2 3609 12 21	21	19.5	28.5	15	31	0.072
14	R3/8 3609 14 17	19	21.5	29	16	34	0.063
	R1/2 3609 14 21	22	21.5	30	16	34	0.072

The body swivels for positioning purposes. Maxi pressure = 20 bar

LF 3600 Push-In Fittings / Stud Fittings

3629 Extended Stud Elbow, Male BSPT Thread

FDA chemical Nickel-plated brass, FKM

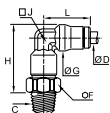

ØD	C		F	G	H	J	L	Kg
4	R1/8	3629 04 10	10	10	24.5	7	18	0.025
	R1/4	3629 06 13	14	12	30.5	8	21.5	0.031
6	R1/8	3629 06 10	13	12	29.5	8	21.5	0.024
	R1/4	3629 06 13	14	12	30.5	8	21.5	0.031
8	R1/8	3629 08 10	14	15	32.5	10	23.5	0.031
	R1/4	3629 08 13	14	15	34	10	23.5	0.037
10	R1/4	3629 10 13	18	17.5	39	12	29	0.054

The body swivels for positioning purposes.

3669 Extended Stud Elbow, Male BSPP and Metric Thread

FDA chemical Nickel-plated brass, FKM

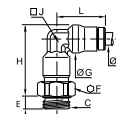

ØD	C		E	F	G	H	J	L	Kg
4	M5x0,8	3669 04 19	3,5	10	10	27,5	7	18	0,014
	G1/8	3669 04 10	4,5	13	10	25,5	7	18	0,017
6	G1/8	3669 06 10	4,5	13	12	31	8	21,5	0,024
	G1/4	3669 06 13	5,5	16	12	30,5	8	21,5	0,028
8	G1/8	3669 08 10	4,5	14	15	33,5	10	23,5	0,031
	G1/4	3669 08 13	5,5	16	15	34	10	23,5	0,035
10	G1/4	3669 10 13	5,5	18	17,5	42	12	29	0,052
	G3/8	3669 10 17	5,5	20	17,5	41	12	29	0,056
12	G1/4	3669 12 13	5,5	20	19,5	47	15	31	0,070
	G3/8	3669 12 17	5,5	20	19,5	46	15	31	0,341
14	G1/2	3669 14 21	7	24	21,5	49	16	34	0,094

The body swivels for positioning purposes.

3699 Compact Elbow, Male BSPP and Metric Thread

FDA chemical Nickel-plated brass, FKM

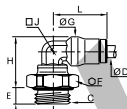

ØD	C		E	F	G	H	J	L	Kg
4	M5x0,8	3699 04 19	3,5	10	10	18	7	18	0,011
	M6x1	3699 04 52	4,5	10	10	18	7	18	0,011
	M8x1	3699 04 56	5	11	10	18	7	18	0,013
	G1/8	3699 04 10	4,5	13	10	17	7	18	0,014
	G1/4	3699 04 13	5,5	16	10	17,5	7	18	0,019
6	M10x1	3699 06 60	5,5	13	12	19	8	21,5	0,017
	G1/8	3699 06 10	4,5	13	12	19	8	21,5	0,018
	G1/4	3699 06 13	5,5	16	12	19,5	8	21,5	0,022
	G1/8	3699 08 10	4,5	13	15	20,5	10	23,5	0,021
	G1/4	3699 08 13	5,5	16	15	21,5	10	23,5	0,027
8	G3/8	3699 08 17	5,5	20	15	21,5	10	23,5	0,033
	G1/4	3699 10 13	5,5	16	17,5	27	12	29	0,037
	G3/8	3699 10 17	5,5	20	17,5	25,5	12	29	0,043
10	G1/4	3699 12 13	5,5	16	19,5	29,5	15	31	0,050
	G3/8	3699 12 17	5,5	20	19,5	28,5	15	31	0,057
12	G1/2	3699 12 21	7	24	19,5	28,5	15	31	0,065
	G3/8	3699 14 17	5,5	20	21,5	29	16	34	0,059
14	G1/2	3699 14 21	7	24	21,5	29,5	16	34	0,062

The body swivels for positioning purposes. Maxi pressure = 20 bar

3608 Stud Branch Tee, Male BSPT Thread

FDA chemical Nickel-plated brass, FKM

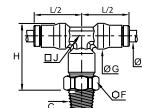

ØD	C		F	G	H	J	L/2	Kg
4	R1/8	3608 04 10	10	10	24.5	7	18	0.020
	R1/4	3608 06 10	13	12	29.5	8	21.5	0.031
6	R1/4	3608 06 13	14	12	30.5	8	21.5	0.038
	R1/8	3608 08 10	14	15	32.5	10	23.5	0.040
8	R1/4	3608 08 13	14	15	34	10	23.5	0.047
	R1/4	3608 10 13	18	17.5	39	12	29	0.067
10	R3/8	3608 10 17	18	17.5	41	12	29	0.070
	R3/8	3608 12 17	20	19.5	46.5	15	31	0.094
14	R1/2	3608 14 21	22	21.5	50.5	16	34	0.125

The body swivels for positioning purposes.

3603 Stud Run Tee, Male BSPT Thread

FDA chemical Nickel-plated brass, FKM

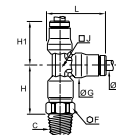

ØD	C		F	G	H	H1	J	L	Kg
4	R1/8	3603 04 10	10	10	19.5	18	7	23	0.018
	R1/8	3603 06 10	13	12	23.5	21.5	8	28	0.031
6	R1/4	3603 06 13	14	12	24.5	21.5	8	28	0.037
	R1/8	3603 08 10	14	15	25	23.5	10	31	0.041
8	R1/4	3603 08 13	14	15	26.5	23.5	10	31	0.044
	R1/4	3603 10 13	18	17.5	30.5	29	12	37.5	0.067
10	R3/8	3603 10 17	18	17.5	32.5	29	12	37.5	0.069
	R3/8	3603 12 17	20	19.5	36.5	31	15	40.5	0.103
14	R1/2	3603 14 21	22	21.5	40	34	16	45	0.147

The body swivels for positioning purposes.

3698 Stud Branch Tee, Male BSPP and Metric Thread

FDA chemical Nickel-plated brass, FKM

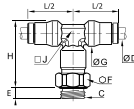

ØD	C		E	F	G	H	J	L/2	Kg
4	M5x0,8	3698 04 19	3,5	10	10	27,5	7	18	0,018
	G1/8	3698 04 10	4,5	13	10	25,5	7	18	0,021
6	G1/8	3698 06 10	4,5	13	12	31	8	21,5	0,031
	G1/4	3698 06 13	5,5	16	12	30,5	8	21,5	0,035
8	G1/8	3698 08 10	4,5	14	15	33,5	10	23,5	0,041
	G1/4	3698 08 13	5,5	16	15	34	10	23,5	0,045
10	G1/4	3698 10 13	5,5	18	17,5	42	12	29	0,066
12	G3/8	3698 12 17	5,5	20	19,5	46	15	31	0,088
14	G1/2	3698 14 21	7	24	21,5	49	16	34	0,119

The body swivels for positioning purposes.

3693 Stud Run Tee, Male BSPP and Metric Thread

FDA chemical Nickel-plated brass, FKM

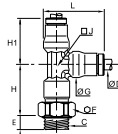

ØD	C		E	F	G	H	H1	J	L	Kg
4	M5x0,8	3693 04 19	3,5	10	10	22,5	18	7	23	0,019
	G1/8	3693 04 10	4,5	13	10	20,5	18	7	23	0,021
6	G1/8	3693 06 10	4,5	13	12	25	21,5	8	28	0,031
	G1/4	3693 06 13	5,5	16	12	24,5	21,5	8	28	0,035
8	G1/8	3693 08 10	4,5	14	15	26,5	23,5	10	31	0,041
	G1/4	3693 08 13	5,5	16	15	26,5	23,5	10	31	0,044
10	G1/4	3693 10 13	5,5	18	17,5	33	29	12	37,5	0,066
12	G3/8	3693 12 17	5,5	20	19,5	36,5	31	15	40,5	0,090
14	G1/2	3693 14 21	7	24	21,5	38,5	34	16	45	0,112

The body swivels for positioning purposes.

3618 Single Banjo, Male BSPP and Metric Thread

FDA chemical Nickel-plated brass, FKM

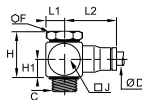

ØD	C		F	H	H1	J	L1	L2	Kg
4	M5x0,8	3618 04 19	8	13	6	10	6	18,5	0,011
	G1/8	3618 04 10	13	16,5	7	15	7,5	22	0,029
6	M5x0,8	3618 06 19	8	13	6	10	5	22,5	0,015
	G1/8	3618 06 10	13	16,5	7	15	7,5	24	0,031
8	G1/4	3618 06 13	17	21	9	18	9	24	0,049
	G1/8	3618 08 10	13	16,5	7	15	7,5	25,5	0,033
10	G1/4	3618 08 13	17	21	9	18	9	26,5	0,051
	G3/8	3618 10 17	20	24,5	11	21,5	11	33	0,105

Maximum temperature: +80°C

LF 3600 Push-In Fittings / Tube-to-Tube Fittings

3606 Equal Tube-to-Tube Connector

FDA chemical Nickel-plated brass, FKM

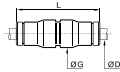

ØD		G	L	Kg
4	3606 04 00	10	30.5	0.010
6	3606 06 00	12	36.5	0.016
8	3606 08 00	15	37.5	0.021
10	3606 10 00	17.5	47.5	0.034
12	3606 12 00	19.5	50	0.042
14	3606 14 00	21.5	52.5	0.050

3602 Equal Elbow

FDA chemical Nickel-plated brass, FKM

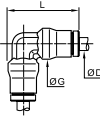

ØD		G	L	Kg
4	3602 04 00	10	23	0.010
6	3602 06 00	12	28	0.016
8	3602 08 00	15	31	0.022
10	3602 10 00	17.5	37.5	0.033
12	3602 12 00	19.5	40.5	0.045
14	3602 14 00	21.5	45	0.056

3604 Equal Tee

FDA chemical Nickel-plated brass, FKM

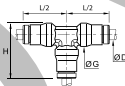

ØD		G	H	L/2	Kg
4	3604 04 00	10	23	18	0.014
6	3604 06 00	12	28	21.5	0.023
8	3604 08 00	15	31	23.5	0.032
10	3604 10 00	17.5	37.5	29	0.048
12	3604 12 00	19.5	40.5	31	0.063
14	3604 14 00	21.5	45	34	0.078

3616 Equal Bulkhead Connector

FDA chemical Nickel-plated brass, FKM

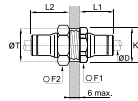

ØD		F1	F2	K	L1	L2	ØT min	Kg
4	3616 04 00	13	14	14	14	20	12.5	0.018
6	3616 06 00	16	17	17.5	17	22	15	0.028
8	3616 08 00	18	19	19.5	18.5	23.5	17	0.036
10	3616 10 00	22	27	24	21.5	26.5	21	0.063
12	3616 12 00	24	24	26	23	27	23	0.062
14	3616 14 00	27	27	29.5	25.5	29.5	25	0.079

3636 Bulkhead Connector, Female BSPP Thread

FDA chemical Nickel-plated brass, FKM

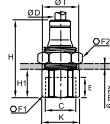

ØD	C		E	F1	F2	H	H1	K	ØT min	Kg
4	G1/8	3636 04 10	8.5	14	14	30.5	11	15	13	0.020
6	G1/8	3636 06 10	8.5	17	17	33	11	18.5	15	0.033
	G1/4	3636 06 13	11.5	17	17	37	15	18.5	15	0.033
8	G1/8	3636 08 10	8.5	19	19	34	10.5	21	17	0.044
	G1/4	3636 08 13	11.5	19	19	38	14.5	21	17	0.044
10	G3/8	3636 10 17	12	22	27	42.5	16	24	21	0.073
12	G3/8	3636 12 17	12	24	24	43	16	26	23	0.077
	G1/2	3636 12 21	16	27	24	48.5	21.5	29.5	23	0.133

3639 Equal Bulkhead Elbow

FDA chemical Nickel-plated brass, FKM

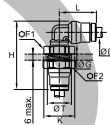

ØD		F1	F2	G	H	K	L	ØT min	Kg
4	3639 04 00	13	14	10	35	14	18	12.5	0.023
6	3639 06 00	16	17	12	40.5	17.5	21.5	15	0.035
8	3639 08 00	18	19	15	44	19.5	23.5	17	0.046
10	3639 10 00	22	27	17.5	51	24	29	21	0.080
12	3639 12 00	24	24	19.5	55	26	31	23	0.086
14	3639 14 00	27	27	21.5	59	29.5	34	25	0.144

The body swivels for positioning purposes.
Maxi pressure = 20 bar

LF 3600 Push-In Fittings / Plug-In Accessories

3666 Plug-In Reducer

FDA chemical Nickel-plated brass, FKM

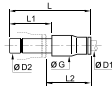

ØD1	ØD2		G	L	L1	L2	Kg
4	6	3666 04 06	10	35	19.5	18	0.008
	8	3666 04 08	10	35.5	20	18	0.009
6	8	3666 06 08	12	38	20	20.5	0.012
	10	3666 06 10	12	43.5	25	21	0.015
8	10	3666 08 10	15	44	25	21.5	0.016
	12	3666 08 12	15	44	26	20.5	0.018
10	12	3666 10 12	17.5	50	26	27	0.026
12	14	3666 12 14	19.5	53	28	28.5	0.032

3667 Plug-In Metric/Inch Adaptor

FDA chemical Nickel-plated brass, FKM

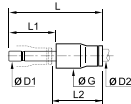

ØD1	ØD2		G	L	L1	L2	Kg
6	1/4	3667 06 56	12.5	38.5	19.5	21	0.012
10	3/8	3667 10 60	17	49.5	25	27	0.026
12	1/2	3667 12 62	20	51	26	27.5	0.030

3668 Plug-In Increaser

FDA chemical Nickel-plated brass, FKM

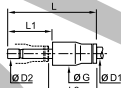

ØD1	ØD2		G	L	L1	L2	Kg
6	4	3668 06 04	12	36	17	21.5	0.010

3622 Plug-In Barb Connector

FDA chemical Nickel-plated brass

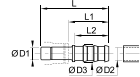

ØD1	ØD2	ØD3		L	L1	L2	Kg
4	3.2	5	3622 04 53	40.5	27	22.5	0.003
	5	7	3622 04 05	40.5	27	22.5	0.005
6	5	7	3622 06 05	43	27	22.5	0.006
8	6.3	8.3	3622 08 56	42	25	22.5	0.008
	8	10	3622 08 08	44	27	22.5	0.010
10	6.3	8.3	3622 10 56	47.5	25.5	22.5	0.011
	8	10	3622 10 08	47.5	25.5	22.5	0.011
12	8	10	3622 12 08	48.5	25.5	22.5	0.015
	10	12	3622 12 10	48.5	25.5	22.5	0.014
14	12.5	14.5	3622 14 62	57	34	29.5	0.019
	12.5	14.5	3622 14 62	57.5	33	29.5	0.022
14	14	16	3622 14 14	59.5	35	29.5	0.023

3620 Male Stem Connector

FDA chemical Nickel-plated brass

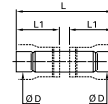

ØD		L	L1	Kg
4	3620 04 00	31	14	0.002
6	3620 06 00	36.5	17	0.005
8	3620 08 00	37.5	17.5	0.007
10	3620 10 00	47.5	22.5	0.011
12	3620 12 00	49.5	23.5	0.015
14	3620 14 00	53	25	0.016

3626 Blanking Plug

FDA chemical Nickel-plated brass

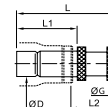

ØD		G	L	L1	L2	Kg
4	3626 04 00	6	25.5	17.5	11.5	0.004
6	3626 06 00	8	30.5	19.5	13.5	0.009
8	3626 08 00	10	33	20	16	0.009
10	3626 10 00	12	40	25	18	0.015
12	3626 12 00	14	43	26	20	0.021
14	3626 14 00	16	47	28	22.5	0.029

LF 3600 Push-In Fittings / Maintenance Kit



• The essential tool to rapidly carry out the main maintenance operations and reduce production interruptions.

Advantages

- A selection of 24 references covering the most-used products
- Products available in the most common diameters: 4 mm, 6 mm and 8 mm
- A kit contains more than 232 products and can be easily completed with our standard products

3650..33 Maintenance Kit, BSP Parallel Thread



3650 00 00 33

H	L	L1	Kg
81	413	330	2,900

KOOLVANNI.COM