



























Basic modules (without connector)

Valve Modules						Size 1		Size 2		
	Symbol	Description	Actuator	Pilot connector	W (g)	Order code	W (g)	Order code		
 <p>Size 1 Dual 4/2</p>		4/2 Spring return	Solenoid	M8 Lockable	68	P2M1T4ES2C	74	P2M2T4ES2C		
			Air pilot	Clip	68	P2M1T4ES2CW	74	P2M2T4ES2CW		
	 <p>Size 1</p>		4/2 Double pilot	Solenoid	M8 Lockable	77	P2M1T4EE2C	83	P2M2T4EE2C	
				Air pilot	Clip	77	P2M1T4EE2CW	83	P2M2T4EE2CW	
		 <p>Size 1</p>		2 x 3/2 NC + NC with exhaust check valves	Solenoid	M8 Lockable	80	P2M1TDEE2C	94	P2M2TDEE2C
					Air pilot	Clip	80	P2M1TDEE2CW	94	P2M2TDEE2CW
 <p>Size 2</p>		2 x 3/2 NO + NO with exhaust check valves	Solenoid	M8 Lockable	80	P2M1TCEE2C	94	P2M2TCEE2C		
			Air pilot	Clip	80	P2M1TCEE2CW	94	P2M2TCEE2CW		
	 <p>Size 2</p>		2 x 3/2 NC + NO with exhaust check valves	Solenoid	M8 Lockable	80	P2M1TCEE2C	94	P2M2TCEE2C	
				Air pilot	Clip	80	P2M1TCEE2CW	94	P2M2TCEE2CW	
	 <p>Size 2</p>		2 x 4/2 Spring return with exhaust check valves	Solenoid	M8 Lockable	80	P2M1TTEEE2C	94	P2M2TTEEE2C	
				Air pilot	Clip	80	P2M1TTEEE2CW	94	P2M2TTEEE2CW	
 <p>Size 2</p>		3/2 NC with exhaust check valves	Solenoid	M8 Lockable	88	P2M1TJEE2C	88	P2M1TJEE2CW		
			Air pilot	Clip	88	P2M1TJEE2CW	88	P2M1TJPP		
	 <p>Size 2</p>		3/2 NC with exhaust check valves	Solenoid	M8 Lockable	76	P2M1T3ES2C	90	P2M2T3ES2C	
				Air pilot	Clip	76	P2M1T3ES2CW	90	P2M2T3ES2CW	
 <p>Size 2</p>		4/3 Centre exhaust	Solenoid	M8 Lockable	80	P2M1T3PS	70	P2M2T3PS		
			Air pilot	Clip	71	P2M1T3PS	70	P2M2T3PS		
 <p>Size 2</p>		2 x 3/2 NC + NC without exhaust check valves	Solenoid	M8 Lockable	80	P2M1TGEE2C	94	P2M2TGEE2C		
			Air pilot	Clip	80	P2M1TGEE2CW	94	P2M2TGEE2CW		
			Air pilot	Clip	70	P2M1TGPP	84	P2M2TGPP		



Island head and intermediate module sets

Valve Modules		Description	W (g)	Order code
 <p>P2M2HXT01</p>	 <p>P2M2BXT0A</p>	Valve island pneumatic head and tail module set	64	P2M2HXT01
		Valve island intermediate supply module with a set of 4 configuration plates	64	P2M2BXT0A

Clip-On pneumatic connectors *

Valve Modules						Size 1		Size 2	
	Description	Tube OD	W (g)	Order code	W (g)	Order code			
   	Straight connector	G1/8"	2	FMDG1-1					
		4 mm	2	FMD04-1					
		6 mm	3	FMD06-1	3	FMD06-2			
		8 mm			4	FMD08-2			
		10 mm			5	FMD10-2			
		12 mm			6	FMD12-2			
	Elbow connector	G1/8"	3	CMDG1-1					
		4 mm	3	CMD04-1					
		6 mm	5	CMD06-1	5	CMD06-2			
		8 mm			6	CMD08-2			
		10 mm			7	CMD10-2			
		12 mm			8	CMD12-2			
Silencer				5	MMDVA2				
Plug			3	PMDXX1	5	PMDXX2			



Electrical connectors

Valve Modules		Description	Connector type	Cable length	W (g)	Order code	
  	M8 lockable connector	Individual lockable connector – IP67 Including LED and surge protection	M8 / 2 x Flying leads	2 meters	62	P8LS08L226C	
				5 meters	155	P8LS08L526C	
				9 meters	180	P8LS08L926C	
	Clip connector	Clip connector – IP40 Individual: Including 2 flying leads Multiple: Including 1 common (0 Vdc) and 1 flying lead per connector	1 x Clip connector	1 meter	8	P8LW021C	
				2 meter	12	P8LW022C	
				2 x Clip connectors	1 meter	12	P8LW021C02
				4 x Clip connectors	1 meter	20	P8LW021C04
				8 x Clip connectors	1 meter	36	P8LW021C08
	Straight cable quick connect to thread connector, IP67 protected			M8	12	P8CS0803J	
				M12	15	P8CS1204J	

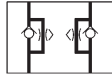
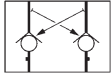
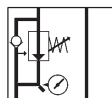
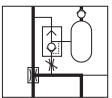
Basic peripheral modules (without connector)



Peripheral Modules		Size 1		Size 2			
Symbol	Description	Weight (g)	Order code	Weight (g)	Order code		
	Dual flow control	50	P2M1PXFA	50	P2M2PXFA		
	Dual P.O. check valve	50	P2M1PXCA	50	P2M2PXCA		
	Pressure regulator	Pressure range	Gauge				
		0 - 2 bar	0 - 4 bar	135	P2M1PXSR	135	P2M2PXSR
			Without	105	P2M1PXST	165	P2M2PXST
		0 - 4 bar	0 - 7 bar	135	P2M1PXSM	135	P2M2PXSM
			Without	105	P2M1PXSL	165	P2M2PXSL
		0 - 8 bar	0 - 11 bar	135	P2M1PXSG	135	P2M2PXSG
	Without	105	P2M1PXSN	165	P2M2PXSN		
	90% Vacuum generator	30	P2M1PXVA				

Clip-On pneumatic connectors *





Valve Modules		Size 1		Size 2		
Description	Tube OD	Weight (g)	Order code	Weight (g)	Order code	
	Straight connector	G1/8"	2	FMDG1-1		
		4 mm	2	FMD04-1		
		6 mm	3	FMD06-1	3	FMD06-2
		8 mm			4	FMD08-2
		10 mm			5	FMD10-2
		12 mm			6	FMD12-2
	Elbow connector	G1/8"	3	CMDG1-1		
		4 mm	3	CMD04-1		
		6 mm	5	CMD06-1	5	CMD06-2
		8 mm			6	CMD08-2
		10 mm			7	CMD10-2
		12 mm			8	CMD12-2
	Double male union	5	HMDXX1	8	HMDXX2	
	Silencer	3	MMDVA1			
	Plug	3	PMDXX1	5	PMDXX2	

* Fittings and plugs pack quantity: 10

Clip-on accessories

Description	Connection	Pressure range	Weight (g)	Order code	
	Clip-on	0 to 4 bar	30	P2M1K0GT	
		0 to 7 bar	30	P2M1K0GL	
		0 to 11 bar	30	P2M1K0GN	
Clip-on pressure gauge for pressure regulator modules, size 1 or size 2					
	Analogue (1 - 5 Vdc) Vacuum Sensor	Diam. 4 mm tube	0 to -1 bar	25	MPS-V8T4-AG
	Flying lead 2 meter cable	Diam. 6 mm tube	0 to -1 bar	25	MPS-V8T-AG
	Dig. PNP / Ana (4 - 20 mA) Vacuum Sensor	G 1/8" male	0 to -1 bar	45	MPS-V34G-PCI
	15 cm cable - M8 4 pin's connector				

Maintenance components

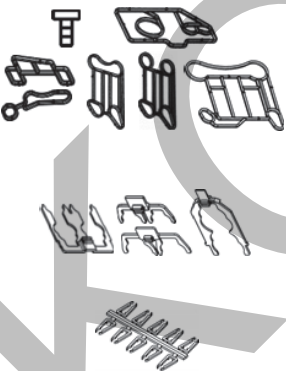
	Valve pilot	Connection	Weight (g)	Order code	
   P2D8V32C5 P2D2W3226C5 P2M2K0PA	Solenoid pilot	M8 - 3 Pins - IP67	15	P2D8V32C5	
		Clip connector - 2 pins - IP40 With LED and voltage surge suppression	15	P2D2W3226C5	
	Pneumatic pilot	4 mm OD tubing push-in elbow fitting	10	P2M2K0PA	
size 1 valve modules without solenoid pilot and without sub-base			Weight (g)	Order code	
 P2M1X4EE	4/2	monostable	26	P2M1X4ES	
		bistable	25	P2M1X4EE	
	3/2	double NC + NC	28	P2M1XDDEE	
		double NO + NO	28	P2M1XCEE	
		double NC + NO	28	P2M1XEEE	
		single NC	25	P2M1X3ES	
	4/3 CE	double 3/2 NC + NC without exhaust check valve	28	P2M1XGEE	
	size 2 valve modules without solenoid pilot and without sub-base			Weight (g)	Order code
	 P2M2X4EE	4/2	monostable	28	P2M2X4ES
			bistable	30	P2M2X4EE
3/2		double NC + NC	32	P2M2XDDEE	
		double NO + NO	32	P2M2XCEE	
		double NC + NO	32	P2M2XEEE	
		single NC	28	P2M2X3ES	
4/3 CE		double 3/2 NC + NC without exhaust check valve	32	P2M2XGEE	
Set of maintenance parts			Weight (g)	Order code	
	Seals	Set of various seals: 3 under solenoid pilot seals 3 inter island base seals 2 for dual 4/2 valves (2 parts) 2 for single and dual 3/2 – Size 1 – valves 2 for single 4/2 – Size 1 – valves 2 for size 2 valves (all functions)	8	P2M2K0JA	
	Fitting locking clips	Set of 14 clips: 4 for dual 4/2 valves 6 for size 1 valves 2 for size 2 valves 2 for intermediate supply modules	10	P2M2K0CA	
	Manual override forks	Set of 10 isolating forks for pilot solenoid manual override	8	P2M2K0FA	