

PAR◇FIT™

Hydraulic and Lubrication
Interchangeable Element Range



Over 50,000 reasons to choose PAR◇FIT™

Quality interchange elements with a proven record

The Parfit range offers end users, maintenance engineers and manufacturers a range of over 50,000 Parker Parfit quality interchangeable elements using Microglass III and Ecoglass III media. Reduce stockholding, cut costs and ensure reliable and quality filter performance.



Contact Information:

Parker Hannifin
Hydraulic Filter Division Europe

**European Product
Information Centre**
Freephone: 00800 27 27 5374
(from AT, BE, CH, CZ, DE, EE, ES,
FI, FR, IE, IT, PT, SE, SK, UK)
filtrationinfo@parker.com

www.parker.com/hfde

Product Features:

- **PAR◇FIT™** elements are manufactured to the same exacting standards as Parker original elements using Microglass III and Ecoglass III media.
- Quality backed by Parker's unrivalled technical resources.
- Reduce stockholding and costs by sourcing all your replacement elements from Parker.
- Interchange elements for Pall, Hydac, Mahle, Internormen, MP Filtri, Donaldson and over 300 more manufacturers.
- Cross reference information available for over 50,000 part numbers.

Hydraulic and Lubrication Interchangeable Element Range

Specification

Features	Advantages	Benefits
Microglass III replacement elements	Multi-layered design producing high dirt holding capacity and high efficiency	Great performance value
	Wire support reduces pleat bunching and keeps performance consistent	Reliable performance throughout element life
		Reduces downtime and maximizes element life
Coreless Ecoglass III replacement elements	No metal content in element	Environmentally friendly disposal by incineration
	Overall weight reduced by 50%	Lower element replacement costs
	Easy compaction of used elements	Lower disposal costs
	Eco adapters available	Retrofit coreless design to housings already installed
Complete performance data disclosure	All pertinent information is provided in an easy to compare format	No hidden deficiencies
		Easy selection of correct interchange part number
Elements manufactured to exacting standards of original elements	Performance guarantee as good if not better than original fit	Durable, rugged and reliable construction with high quality standards

Typical Applications

- Industrial power units
- Mobile construction equipment
- Forestry equipment
- Marine power plants
- Agricultural equipment
- Lorry mounted cranes
- Waste management trucks
- Wheeled loaders
- Lift trucks

There's only one solution

When it comes to replacement hydraulic and marine filter elements there is only one solution:

The **PAR◇FIT™** interchangeable range.

With over 20,000 stocked, off the shelf variations, there's a **PAR◇FIT™** element to fit most sizes and makes of filters on mobile, construction, agricultural and industrial plant.

Every **PAR◇FIT™** element is manufactured in Europe to the highest standards and is backed by our unrivalled technical support and money back guarantees.

That means that you can reduce stockholdings, cut costs and be sure of the ultimate performance, with long, trouble free operating life.

PAR◇FIT™ filters are available from ParkerStores and authorised distributors throughout Europe.

www.parker.com/parfit

Hydac interchange element range

- The latest interchange elements range added are for the latest Hydac "R" type elements.
- Replacement sizes available are for Hydac: 0030, 0060, 0075, 0110, 0160, 0165, 0240, 0330 0500, 0660, 0850, 0950, 1300, 1700 and 2600.
- Featuring Fluroelastomer seals as standard for optimum performance.
- Top and bottom end caps manufactured from glass reinforced nylon.
- Top end cap includes integrated bypass assembly.
- Bottom end cap features a bayonet locking lug for use with the re-useable contamination retainer (Not supplied).
- Elements are suitable for use with the following Hydac housings: RD, RFD, RFM, RFL, RFLD, NF, NFD and oil service units as well as many OEM applications.

Hydraulic and Lubrication Interchangeable Element Range



Part Numbers

Note: Bold and darker tint panel indicates the item is standard and available to order immediately.

Filter Element Competitor	Filter Element Competitor Part Number	Parker Part Number	Filter Element Competitor	Filter Element Competitor Part Number	Parker Part Number
Argo	Replaces P2.0620-51	PR4474	Donaldson	Replaces P170090	926372
Argo	Replaces P2.0923-01	PR4473	Donaldson	Replaces P170092	926326
Argo	Replaces P2.0933-01	PR4461	Donaldson	Replaces P170094	926327
Argo	Replaces P2.1217-12	PR4465	Donaldson	Replaces P170095	907233
Argo	Replaces P2.1217-21	PR4466	Donaldson	Replaces P170096	907234
Argo	Replaces P3.0510-00	PR4469	Donaldson	Replaces P170098	924588
Argo	Replaces P3.0510-02	PR4475	Donaldson	Replaces P170099	932635Q
Argo	Replaces P3.0920-11	PR4464	Donaldson	Replaces P170481	930226
Argo	Replaces V2.1217-03	938194Q	Donaldson	Replaces P170906	944040Q
Argo	Replaces V2.1217-08	PR4467	Donaldson	Replaces P171273	944042Q
Argo	Replaces V2.1217-36	PR4468	Donaldson	Replaces P171274	944043Q
Argo	Replaces V3.0510-03	944074Q	Donaldson	Replaces P171275	944044Q
Argo	Replaces V3.0510-06	944075Q	Donaldson	Replaces P171276	944045Q
Argo	Replaces V3.0510-08	944076Q	Donaldson	Replaces P173616	909297
Argo	Replaces V3.0520-08	PR4476	Donaldson	Replaces P176565	944032Q
Argo	Replaces V3.0607-06	PR4471	Donaldson	Replaces P176566	944033Q
Argo	Replaces V3.0607-08	PR4472	Donaldson	Replaces P176567	944047Q
Argo	Replaces V3.0723-08	944097Q	Donaldson	Replaces P550251	927736
Argo	Replaces V3.0933-08	944098Q	Donaldson	Replaces P551551	921999
Donaldson	Replaces P163322	944012Q	Donaldson	Replaces P551553	925023
Donaldson	Replaces P163323	944013Q	Donaldson	Replaces P556005	934476
Donaldson	Replaces P163324	944014Q	Donaldson	Replaces SP0715	943999Q
Donaldson	Replaces P163405	944015Q	Eaton Vickers	Replaces 737842	930091
Donaldson	Replaces P163419	944016Q	Eaton Vickers	Replaces 737846	930110
Donaldson	Replaces P163496	944017Q	Eaton Vickers	Replaces V3045B1H10	933576Q
Donaldson	Replaces P164375	944022Q	Eaton Vickers	Replaces V3045V1H03	933577Q
Donaldson	Replaces P164378	944023Q	Eaton Vickers	Replaces V3045V2H03	933578Q
Donaldson	Replaces P164381	944024Q	Eaton Vickers	Replaces V3045V2H05	932620Q
Donaldson	Replaces P164384	944025Q	Eaton Vickers	Replaces V3045V2H10	933579Q
Donaldson	Replaces P164996	924732	Eaton Vickers	Replaces V30PV1C03	932622Q
Donaldson	Replaces P165104	924493	Eaton Vickers	Replaces V30PV1C05	932623Q
Donaldson	Replaces P165106	924489	Eaton Vickers	Replaces V30PV1C10	932624Q
Donaldson	Replaces P165114	924735	Eaton Vickers	Replaces V30PV1C20	933135Q
Donaldson	Replaces P165332	944027Q	Eaton Vickers	Replaces V30PV1H03	932625Q
Donaldson	Replaces P165335	944028Q	Eaton Vickers	Replaces V30PV1H03	933580Q
Donaldson	Replaces P165338	944029Q	Eaton Vickers	Replaces V30PV1H05	932626Q
Donaldson	Replaces P165354	944030Q	Eaton Vickers	Replaces V30PV1H10	932627Q
Donaldson	Replaces P165569	944035Q	Eaton Vickers	Replaces V30PV1H10	933581Q
Donaldson	Replaces P165659	944036Q	Eaton Vickers	Replaces V30PV2C03	932628Q
Donaldson	Replaces P165672	944037Q	Eaton Vickers	Replaces V30PV2C05	932629Q
Donaldson	Replaces P165675	944038Q	Eaton Vickers	Replaces V30PV2C10	932630Q
Donaldson	Replaces P165705	944039Q	Eaton Vickers	Replaces V30PV2C20	933136Q
Donaldson	Replaces P165786-24	922787	Eaton Vickers	Replaces V30PV2H03	932631Q
Donaldson	Replaces P165879	926170	Eaton Vickers	Replaces V30PV2H03	933582Q
Donaldson	Replaces P166204	908649	Eaton Vickers	Replaces V30PV2H05	932632Q
Donaldson	Replaces P169430	926541	Eaton Vickers	Replaces V30PV2H10	932633Q
Donaldson	Replaces P169553	924451	Eaton Vickers	Replaces V30PV2H10	933583Q
Donaldson	Replaces P169554	924449	Eaton Vickers	Replaces VCF2B1C05	924452Q
Donaldson	Replaces P169555	924450	Eaton Vickers	Replaces VCF2B1C10	924453Q
Donaldson	Replaces P169556	924452	Eaton Vickers	Replaces VCF2B2C10	934265Q
Donaldson	Replaces P169558	924793	Eaton Vickers	Replaces VCF2V1C05	925039Q
Donaldson	Replaces P169559	924791	Eaton Vickers	Replaces VCF2V1C10	925040Q
Donaldson	Replaces P169560	924792	Eaton Vickers	Replaces VCF2V2C05	935534Q
Donaldson	Replaces P170061	924467	Eaton Vickers	Replaces VCF2V2C10	935535Q
Donaldson	Replaces P170063	908648	Eaton Vickers	Replaces VRF2B1C03	932686Q
Donaldson	Replaces P170065	922625	Eaton Vickers	Replaces VRF2B1C05	932687Q
Donaldson	Replaces P170066	922624	Eaton Vickers	Replaces VRF2B1C10	932688Q

Hydraulic and Lubrication Interchangeable Element Range

Part Numbers

Note: Bold and darker tint panel indicates the item is standard and available to order immediately.

Filter Element Competitor	Filter Element Competitor Part Number	Parker Part Number	Filter Element Competitor	Filter Element Competitor Part Number	Parker Part Number
Eaton Vickers	Replaces VRF2B1C20	933116Q	Hydac	Replaces 0075R003BN4HC	938261Q
Eaton Vickers	Replaces VRF2B2C03	932692Q	Hydac	Replaces 0075R005BN4HC	938262Q
Eaton Vickers	Replaces VRF2B2C05	932693Q	Hydac	Replaces 0075R010BN4HC	938263Q
Eaton Vickers	Replaces VRF2B2C10	932694Q	Hydac	Replaces 0075R020BN4HC	938264Q
Eaton Vickers	Replaces VRF2B2C20	933117Q	Hydac	Replaces 0095D010BN4HC	938154Q
Eaton Vickers	Replaces VRF2V1C03	932689Q	Hydac	Replaces 0110D003BH4HC	PR3093Q
Eaton Vickers	Replaces VRF2V1C05	932690Q	Hydac	Replaces 0110D003BN4HC	PR3085Q
Eaton Vickers	Replaces VRF2V1C10	932691Q	Hydac	Replaces 0110D005BH4HC	PR3094Q
Eaton Vickers	Replaces VRF2V1C20	933118Q	Hydac	Replaces 0110D005BN4HC	PR3086Q
Eaton Vickers	Replaces VRF2V2C03	932695Q	Hydac	Replaces 0110D010BH4HC	PR3095Q
Eaton Vickers	Replaces VRF2V2C05	932696Q	Hydac	Replaces 0110D010BN4HC	PR3087Q
Eaton Vickers	Replaces VRF2V2C10	932697Q	Hydac	Replaces 0110D020BH4HC	PR3096Q
Eaton Vickers	Replaces VRF2V2C20	933119Q	Hydac	Replaces 0110D020BN4HC	PR3088Q
Eppensteiner	Replaces 1.0145 H6SL-A-000-P	936789Q	Hydac	Replaces 0110R003BN4HC	938265Q
Eppensteiner	Replaces 1.561 H3SL-C-000-P(S)	936736Q	Hydac	Replaces 0110R005BN4HC	938266Q
Eppensteiner	Replaces 1.561 H6SL-A-000-P	936869Q	Hydac	Replaces 0110R010BN4HC	938267Q
Eppensteiner	Replaces 1.561 H6SL-C-000-P	936816Q	Hydac	Replaces 0110R020BN4HC	938268Q
Eppensteiner	Replaces 1-0145 H3SL-A-000-P	936737Q	Hydac	Replaces 0140D003BH4HC	937059Q
Eppensteiner	Replaces 2.0030 H6SL-A-000-P	938155Q	Hydac	Replaces 0140D003BN4HC	937060Q
Eppensteiner	Replaces 2.0030 H6SL-B00-0-P	936784Q	Hydac	Replaces 0140D005BH4HC	937061Q
Eppensteiner	Replaces 2.140H6SL-C-000-P	936787Q	Hydac	Replaces 0140D005BN4HC	937062Q
Eppensteiner	Replaces 2.22 H6SL-C-000-P	936786Q	Hydac	Replaces 0140D010BH4HC	937063Q
Eppensteiner	Replaces 2.56G2525-C-000-PS	936785Q	Hydac	Replaces 0140D010BN4HC	937064Q
Eppensteiner	Replaces 9.05242 P25-S00-0-PX	944090Q	Hydac	Replaces 0140D020BH4HC	937065Q
Filtration Products Corp	Replaces FPL1270B05G	935202	Hydac	Replaces 0140D020BN4HC	937066Q
Filtration Products Corp	Replaces FPL1370B05G	935210	Hydac	Replaces 0160D003BH4HC	PR3122Q
Filtration Products Corp	Replaces FPL2270B05G	935206	Hydac	Replaces 0160D003BN4HC	PR3114Q
Filtration Products Corp	Replaces FPL2370B05G	935214	Hydac	Replaces 0160D005BH4HC	PR3123Q
Fleetguard	Replaces HF7808	982131	Hydac	Replaces 0160D005BN4HC	PR3115Q
Fleetguard	Replaces HF7809	983061	Hydac	Replaces 0160D010BH4HC	PR3124Q
Hydac	Replaces 0015D010BN4HC	938156Q	Hydac	Replaces 0160D010BN4HC	PR3116Q
Hydac	Replaces 0030D003BH4HC	PR3035Q	Hydac	Replaces 0160D020BH4HC	PR3125Q
Hydac	Replaces 0030D003BN4HC	PR3031Q	Hydac	Replaces 0160D020BN4HC	PR3117Q
Hydac	Replaces 0030D005BH4HC	PR3036Q	Hydac	Replaces 0160R003BN4HC	938269Q
Hydac	Replaces 0030D005BN4HC	PR3032Q	Hydac	Replaces 0160R005BN4HC	938270Q
Hydac	Replaces 0030D010BH4HC	PR3037Q	Hydac	Replaces 0160R010BN4HC	938271Q
Hydac	Replaces 0030D010BN4HC	PR3033Q	Hydac	Replaces 0160R020BN4HC	938272Q
Hydac	Replaces 0030D020BH4HC	PR3038Q	Hydac	Replaces 0165R003BN4HC	938273Q
Hydac	Replaces 0030D020BN4HC	PR3034Q	Hydac	Replaces 0165R005BN4HC	938274Q
Hydac	Replaces 0030D025W	939159Q	Hydac	Replaces 0165R010BN4HC	938275Q
Hydac	Replaces 0030R003BN4HC	938253Q	Hydac	Replaces 0165R020BN4HC	938276Q
Hydac	Replaces 0030R005BN4HC	938254Q	Hydac	Replaces 0240D003BH4HC	PR3151Q
Hydac	Replaces 0030R010BN4HC	938255Q	Hydac	Replaces 0240D003BN4HC	PR3143Q
Hydac	Replaces 0030R020BN4HC	938256Q	Hydac	Replaces 0240D005BH4HC	PR3152Q
Hydac	Replaces 0035D020BN4HC	937058Q	Hydac	Replaces 0240D005BN4HC	PR3144Q
Hydac	Replaces 0060D003BH4HC	PR3064Q	Hydac	Replaces 0240D010BH4HC	PR3153Q
Hydac	Replaces 0060D003BN4HC	PR3056Q	Hydac	Replaces 0240D010BN4HC	PR3145Q
Hydac	Replaces 0060D005BH4HC	PR3065Q	Hydac	Replaces 0240D020BH4HC	PR3154Q
Hydac	Replaces 0060D005BN4HC	PR3057Q	Hydac	Replaces 0240D020BN4HC	PR3146Q
Hydac	Replaces 0060D010BH4HC	PR3066Q	Hydac	Replaces 0240D200WHC	938195Q
Hydac	Replaces 0060D010BN4HC	PR3058Q	Hydac	Replaces 0240R003BN4HC	938277Q
Hydac	Replaces 0060D020BH4HC	PR3067Q	Hydac	Replaces 0240R005BN4HC	938278Q
Hydac	Replaces 0060D020BN4HC	PR3059Q	Hydac	Replaces 0240R010BN4HC	938279Q
Hydac	Replaces 0060R003BN4HC	938257Q	Hydac	Replaces 0240R020BN4HC	938280Q
Hydac	Replaces 0060R005BN4HC	938258Q	Hydac	Replaces 0330D003BH4HC	PR3180Q
Hydac	Replaces 0060R010BN4HC	938259Q	Hydac	Replaces 0330D003BN4HC	PR3172Q
Hydac	Replaces 0060R020BN4HC	938260Q	Hydac	Replaces 0330D005BH4HC	PR3181Q

Hydraulic and Lubrication Interchangeable Element Range



Part Numbers

Note: Bold and darker tint panel indicates the item is standard and available to order immediately.

Filter Element Competitor	Filter Element Competitor Part Number	Parker Part Number	Filter Element Competitor	Filter Element Competitor Part Number	Parker Part Number
Hydac	Replaces 0330D005BN4HC	PR3173Q	Hydac	Replaces 1700R003BN4HC	938305Q
Hydac	Replaces 0330D010BH4HC	PR3182Q	Hydac	Replaces 1700R005BN4HC	938306Q
Hydac	Replaces 0330D010BN4HC	PR3174Q	Hydac	Replaces 1700R010BN4HC	938307Q
Hydac	Replaces 0330D020BH4HC	PR3183Q	Hydac	Replaces 1700R020BN4HC	938308Q
Hydac	Replaces 0330D020BN4HC	PR3175Q	Hydac	Replaces 2600R003BN4HC	938310Q
Hydac	Replaces 0330R003BN4HC	938281Q	Hydac	Replaces 2600R005BN4HC	938311Q
Hydac	Replaces 0330R005BN4HC	938282Q	Hydac	Replaces 2600R010BN4HC	938312Q
Hydac	Replaces 0330R010BN4HC	938283Q	Hydac	Replaces 2600R020BN4HC	938313Q
Hydac	Replaces 0330R020BN4HC	938284Q	Hydac	Replaces 0100RK010BN4HC	944091Q
Hydac	Replaces 0480D003BH4HC	937067Q	Hydac	Replaces 0100RK015BN4HC	944092Q
Hydac	Replaces 0480D003BN4HC	937068Q	Hydac	Replaces 1320D010BH4HC	941693
Hydac	Replaces 0480D005BH4HC	937069Q	Internormen	Replaces 01.E 170.10VG.30.E.V	938232Q
Hydac	Replaces 0480D005BN4HC	937070Q	Internormen	Replaces 01.E 170.10VG.HR.E.V	938172Q
Hydac	Replaces 0480D010BH4HC	937071Q	Internormen	Replaces 01.E 170.25VG.30.E.V	938233Q
Hydac	Replaces 0480D010BN4HC	937072Q	Internormen	Replaces 01.E 170.25VG.HR.E.V	938173Q
Hydac	Replaces 0480D020BH4HC	937073Q	Internormen	Replaces 01.E 170.3VG.30.E.V	938230Q
Hydac	Replaces 0480D020BN4HC	937074Q	Internormen	Replaces 01.E 170.3VG.HR.E.V	938170Q
Hydac	Replaces 0480R003BN4HC	944058Q	Internormen	Replaces 01.E 170.6VG.30.E.V	938231Q
Hydac	Replaces 0480R005BN4HC	944059Q	Internormen	Replaces 01.E 170.6VG.HR.E.V	938171Q
Hydac	Replaces 0480R010BN4HC	944060Q	Internormen	Replaces 01.E 210.10VG.16.S.V	938188Q
Hydac	Replaces 0480R020BN4HC	944061Q	Internormen	Replaces 01.E 210.25VG.16.S.V	938189Q
Hydac	Replaces 0500D003BH4HC	937075Q	Internormen	Replaces 01.E 210.3VG.16.S.V	938186Q
Hydac	Replaces 0500D003BN4HC	937076Q	Internormen	Replaces 01.E 210.6VG.16.S.V	938187Q
Hydac	Replaces 0500D005BH4HC	937077Q	Internormen	Replaces 01.E 30.10VG.30.E.V	938244Q
Hydac	Replaces 0500D005BN4HC	937078Q	Internormen	Replaces 01.E 30.25VG.30.E.V	938245Q
Hydac	Replaces 0500D010BH4HC	937079Q	Internormen	Replaces 01.E 30.3VG.30.E.V	938242Q
Hydac	Replaces 0500D010BN4HC	937080Q	Internormen	Replaces 01.E 30.6VG.30.E.V	938243Q
Hydac	Replaces 0500D020BH4HC	937081Q	Internormen	Replaces 01.E 320.10VG.16.S.V	938168Q
Hydac	Replaces 0500D020BN4HC	937082Q	Internormen	Replaces 01.E 320.25VG.16.S.V	938169Q
Hydac	Replaces 0500R003BN4HC	938285Q	Internormen	Replaces 01.E 320.3VG.16.S.V	938166Q
Hydac	Replaces 0500R005BN4HC	938286Q	Internormen	Replaces 01.E 320.6VG.16.S.V	938167Q
Hydac	Replaces 0500R010BN4HC	938287Q	Internormen	Replaces 01.E 360.10VG.30.E.V	938220Q
Hydac	Replaces 0500R020BN4HC	938288Q	Internormen	Replaces 01.E 360.10VG.HR.E.V	938176Q
Hydac	Replaces 0660D003BH4HC	PR3209Q	Internormen	Replaces 01.E 360.25VG.30.E.V	938221Q
Hydac	Replaces 0660D003BN4HC	PR3201Q	Internormen	Replaces 01.E 360.25VG.HR.E.V	938177Q
Hydac	Replaces 0660D005BH4HC	PR3210Q	Internormen	Replaces 01.E 360.3VG.30.E.V	938218Q
Hydac	Replaces 0660D005BN4HC	PR3202Q	Internormen	Replaces 01.E 360.3VG.HR.E.V	938174Q
Hydac	Replaces 0660D010BH4HC	PR3211Q	Internormen	Replaces 01.E 360.6VG.30.E.V	938219Q
Hydac	Replaces 0660D010BN4HC	PR3203Q	Internormen	Replaces 01.E 360.6VG.HR.E.V	938175Q
Hydac	Replaces 0660D020BH4HC	PR3212Q	Internormen	Replaces 01.E 425.10VG.16.E.V	938236Q
Hydac	Replaces 0660D020BN4HC	PR3204Q	Internormen	Replaces 01.E 425.10VG.16.S.V	938192Q
Hydac	Replaces 0660R003BN4HC	938289Q	Internormen	Replaces 01.E 425.25VG.16.E.V	938237Q
Hydac	Replaces 0660R005BN4HC	938290Q	Internormen	Replaces 01.E 425.25VG.16.S.V	938193Q
Hydac	Replaces 0660R010BN4HC	938291Q	Internormen	Replaces 01.E 425.3VG.16.E.V	938234Q
Hydac	Replaces 0660R020BN4HC	938292Q	Internormen	Replaces 01.E 425.6VG.16.E.V	938235Q
Hydac	Replaces 0850R003BN4HC	938293Q	Internormen	Replaces 01.E 450.10VG.30.E.V	938224Q
Hydac	Replaces 0850R005BN4HC	938294Q	Internormen	Replaces 01.E 450.10VG.HR.E.V	938216Q
Hydac	Replaces 0850R010BN4HC	938295Q	Internormen	Replaces 01.E 450.25VG.30.E.V	938225Q
Hydac	Replaces 0850R020BN4HC	938296Q	Internormen	Replaces 01.E 450.25VG.HR.E.V	938217Q
Hydac	Replaces 0950R003BN4HC	938297Q	Internormen	Replaces 01.E 450.3VG.30.E.V	938222Q
Hydac	Replaces 0950R005BN4HC	938298Q	Internormen	Replaces 01.E 450.3VG.HR.E.V	938214Q
Hydac	Replaces 0950R010BN4HC	938299Q	Internormen	Replaces 01.E 450.6VG.30.E.V	938223Q
Hydac	Replaces 0950R020BN4HC	938300Q	Internormen	Replaces 01.E 450.6VG.HR.E.V	938215Q
Hydac	Replaces 1300R003BN4HC	938301Q	Internormen	Replaces 01.E 631.10VG.16.S.V	938212Q
Hydac	Replaces 1300R005BN4HC	938302Q	Internormen	Replaces 01.E 631.25VG.16.S.V	938213Q
Hydac	Replaces 1300R010BN4HC	938303Q	Internormen	Replaces 01.E 631.3VG.16.S.V	938210Q
Hydac	Replaces 1300R020BN4HC	938304Q	Internormen	Replaces 01.E 631.6VG.16.S.V	938211Q

Hydraulic and Lubrication Interchangeable Element Range

Part Numbers

Note: Bold and darker tint panel indicates the item is standard and available to order immediately.

Filter Element Competitor	Filter Element Competitor Part Number	Parker Part Number
Internormen	Replaces 01.E 90.10VG.HR.E.V	938240Q
Internormen	Replaces 01.E 90.25VG.HR.E.V	938241Q
Internormen	Replaces 01.E 90.3VG.HR.E.V	938238Q
Internormen	Replaces 01.E 90.6VG.HR.E.V	938239Q
Internormen	Replaces 01.E.240.10VG.HR.E.V	938228Q
Internormen	Replaces 01.E.240.25VG.HR.E.V	938229Q
Internormen	Replaces 01.E.240.3VG.HR.E.V	938226Q
Internormen	Replaces 01.E.240.6VG.HR.E.V	938227Q
Internormen	Replaces 01.E.425.3VG.16.S.V	938190Q
Internormen	Replaces 01.E.425.6VG.16.S.V	938191Q
Internormen	Replaces 01.NBF 25-40.3VL.B.P	938251Q
Internormen	Replaces 01.NBF 55-85.3VL.B.P	938252Q
Internormen	Replaces 01.NL 100.10VG.30.E.V	938184Q
Internormen	Replaces 01.NL 100.25VG.30.E.V	938185Q
Internormen	Replaces 01.NL 100.3VG.30.E.V	938182Q
Internormen	Replaces 01.NL 100.6VG.30.E.V	938183Q
Internormen	Replaces 01.NL 63.10VG.30.E.V	938180Q
Internormen	Replaces 01.NL 63.25VG.30.E.V	938181Q
Internormen	Replaces 01.NL 63.3VG.30.E.V	938178Q
Internormen	Replaces 01.NL 63.6VG.30.E.V	938179Q
Internormen	Replaces 01.NL.40.10VG.HR.E.V	938248Q
Internormen	Replaces 01.NL.40.25VG.HR.E.V	938249Q
Internormen	Replaces 01.NL.40.3VG.HR.E.V	938246Q
Internormen	Replaces 01.NL.40.6VG.HR.E.V	938247Q
Internormen	Replaces 01.E 120.25VG.16.S.V	939723Q
Internormen	Replaces 01.E 30.25VG.HR.E.V	939736Q
Internormen	Replaces 01.E 330.10VG.16.S.V	939727Q
Internormen	Replaces 01.E 41.10VG.16.S.V	939728Q
Internormen	Replaces 01.E 90.250G.HR.E.P.	939738Q
Internormen	Replaces 01.E 900.10VG.30.E.V	939734Q
Internormen	Replaces 01.E 950.10VG.10.S.V	939725Q
Internormen	Replaces 01.E 950.25P.10.S.V	939732Q
Internormen	Replaces 01.N 100.80G.16.E.V	939726Q
Internormen	Replaces 01.NL 40.25VG.30.E.V	939730Q
Internormen	Replaces 01.NL.630.25VG.30.S.V	939737Q
Internormen	Replaces 01.TS 210.25VG.B	939729Q
Mahle	Replaces 852 126 Mic 10	PR4381Q
Mahle	Replaces 852 127 Sm vst 3	937104Q
Mahle	Replaces 852 127 SMX 10	937100Q
Mahle	Replaces 852 127 SMX 25	937101Q
Mahle	Replaces 852 127 SMX 3	937102Q
Mahle	Replaces 852 127 SMX VST 10	937103Q
Mahle	Replaces 852 127 SMX VST 3	937099Q
Mahle	Replaces 852 435 SM 10	PR4375Q
Mahle	Replaces 852 435 SM 25	PR4374Q
Mahle	Replaces 852 436 SM 10	PR4377Q
Mahle	Replaces 852 436 SM 25	PR4376Q
Mahle	Replaces 852 439 Sm 10	937105Q
Mahle	Replaces 852 519 Mic 10	937106Q
Mahle	Replaces 852 519 Sm L	937107Q
Mahle	Replaces 852 690 Sm 10	937108Q
Mahle	Replaces 852 760 Sm 10	937109Q
Mahle	Replaces 852 760 Sm 25	937110Q
Mahle	Replaces 852 761 Mic 10	PR4378Q
Mahle	Replaces 852 761 SM 10	PR4380Q
Mahle	Replaces 852 761 SM 25	PR4379Q
Mahle	Replaces Pi1005Mic25	PR2829Q

Filter Element Competitor	Filter Element Competitor Part Number	Parker Part Number
Mahle	Replaces Pi1008Mic25	PR2837Q
Mahle	Replaces Pi1011Mic25	PR2845Q
Mahle	Replaces Pi1015Mic25	PR2853Q
Mahle	Replaces Pi1030MIC25	PR2861Q
Mahle	Replaces Pi1045Mic25	PR2869Q
Mahle	Replaces Pi1105Mic10	PR2828Q
Mahle	Replaces Pi1108Mic10	PR2836Q
Mahle	Replaces Pi1111Mic10	PR2844Q
Mahle	Replaces Pi1115Mic10	PR2852Q
Mahle	Replaces Pi1130Mic10	PR2860Q
Mahle	Replaces Pi1145Mic10	PR2868Q
Mahle	Replaces Pi21004DNSM-X3	PR4522Q
Mahle	Replaces Pi21006DNSM-X3	PR4526Q
Mahle	Replaces Pi21010DNSM-X3	PR4530Q
Mahle	Replaces Pi21016DNSM-X3	PR4534Q
Mahle	Replaces Pi21025DNSM-X3	PR4538Q
Mahle	Replaces Pi21040DNSM-X3	PR4542Q
Mahle	Replaces Pi21040RNSM-X03	PR4508Q
Mahle	Replaces Pi2105 SMX 3	PR2830Q
Mahle	Replaces Pi21063RNSM-X03	PR4512Q
Mahle	Replaces Pi2108SMX3	PR2838Q
Mahle	Replaces Pi21100RNSM-X03	PR4516Q
Mahle	Replaces Pi2111SMX3	PR2846Q
Mahle	Replaces Pi2115SMX3	PR2854Q
Mahle	Replaces Pi2130SMX3	PR2862Q
Mahle	Replaces Pi2145SMX3	PR2870Q
Mahle	Replaces Pi22010RNSM-X06	PR4499Q
Mahle	Replaces Pi22016RNSM-X06	PR4502Q
Mahle	Replaces Pi22025RNSM-X06	PR4505Q
Mahle	Replaces Pi22040RNSM-X06	PR4509Q
Mahle	Replaces Pi2205SMXVST3	PR2833Q
Mahle	Replaces Pi22063RNSM-X06	PR4513Q
Mahle	Replaces Pi2208SMXVST3	PR2841Q
Mahle	Replaces Pi22100RNSM-X06	PR4517Q
Mahle	Replaces Pi2211SMXVST3	PR2849Q
Mahle	Replaces Pi2215SMXVST3	PR2857Q
Mahle	Replaces Pi2230SMXVST3	PR2865Q
Mahle	Replaces Pi2245SMXVST3	PR2873Q
Mahle	Replaces Pi23004DNSM-X10	PR4523Q
Mahle	Replaces Pi23006DNSM-X10	PR4527Q
Mahle	Replaces Pi23010DNSM-X10	PR4531Q
Mahle	Replaces Pi23010RNSM-X10	PR4500Q
Mahle	Replaces Pi23016DNSM-X10	PR4535Q
Mahle	Replaces Pi23016RNSM-X10	PR4503Q
Mahle	Replaces Pi23025DNSM-X10	PR4539Q
Mahle	Replaces Pi23025RNSM-X10	PR4506Q
Mahle	Replaces Pi23040DNSM-X10	PR4543Q
Mahle	Replaces Pi23040RNSM-X10	PR4510Q
Mahle	Replaces Pi23063RNSM-X10	PR4514Q
Mahle	Replaces Pi23100RNSM-X10	PR4518Q
Mahle	Replaces Pi25010RNSM-X25	PR4501Q
Mahle	Replaces Pi25016RNSM-X25	PR4504Q
Mahle	Replaces Pi25025RNSM-X25	PR4507Q
Mahle	Replaces Pi25040RNSM-X25	PR4511Q
Mahle	Replaces Pi25063RNSM-X25	PR4515Q
Mahle	Replaces Pi25100RNSM-X25	PR4519Q
Mahle	Replaces Pi3105 SMX 10	PR2831Q

Hydraulic and Lubrication Interchangeable Element Range



Part Numbers

Note: Bold and darker tint panel indicates the item is standard and available to order immediately.

Filter Element Competitor	Filter Element Competitor Part Number	Parker Part Number	Filter Element Competitor	Filter Element Competitor Part Number	Parker Part Number
Mahle	Replaces Pi3108 SMX 10	PR2839Q	MP Filtri	Replaces CU100P10VN	943804Q
Mahle	Replaces Pi3111 SMX 10	PR2847Q	MP Filtri	Replaces CU100P25VN	943804Q
Mahle	Replaces Pi3115 SMX10	PR2855Q	MP Filtri	Replaces CU200A03VN	943805Q
Mahle	Replaces Pi3130 SMX10	PR2863Q	MP Filtri	Replaces CU200A06VN	943806Q
Mahle	Replaces Pi3145 SMX10	PR2871Q	MP Filtri	Replaces CU200A10VN	943807Q
Mahle	Replaces Pi3205 SMXVST10	PR2834Q	MP Filtri	Replaces CU200A25VN	943808Q
Mahle	Replaces Pi3208 SMXVST10	PR2842Q	MP Filtri	Replaces CU200M25VN	943808Q
Mahle	Replaces Pi3211 SMXVST10	PR2850Q	MP Filtri	Replaces CU200P10VN	943808Q
Mahle	Replaces Pi3215 SMXVST10	PR2858Q	MP Filtri	Replaces CU200P25VN	943808Q
Mahle	Replaces Pi3230 SMXVST10	PR2866Q	MP Filtri	Replaces CU250A03VN	943809Q
Mahle	Replaces Pi3245 SMXVST10	PR2874Q	MP Filtri	Replaces CU250A06VN	943810Q
Mahle	Replaces Pi4105 SMX25	PR2832Q	MP Filtri	Replaces CU250A10VN	943811Q
Mahle	Replaces Pi4108 SMX25	PR2840Q	MP Filtri	Replaces CU250A25VN	943812Q
Mahle	Replaces Pi4111 SMX25	PR2848Q	MP Filtri	Replaces CU250M25VN	943812Q
Mahle	Replaces Pi4115 SMX25	PR2856Q	MP Filtri	Replaces CU250P10VN	943812Q
Mahle	Replaces Pi4130 SMX25	PR2864Q	MP Filtri	Replaces CU250P25VN	943812Q
Mahle	Replaces Pi4145 SMX25	PR2872Q	MP Filtri	Replaces CU350A03VN	943813Q
Mahle	Replaces Pi4205 SMXVST25	PR2835Q	MP Filtri	Replaces CU350A06VN	943814Q
Mahle	Replaces Pi4208 SMXVST25	PR2843Q	MP Filtri	Replaces CU350A10VN	943815Q
Mahle	Replaces Pi4211 SMXVST25	PR2851Q	MP Filtri	Replaces CU350A25VN	943816Q
Mahle	Replaces Pi4215 SMXVST25	PR2859Q	MP Filtri	Replaces CU350M25VN	943816Q
Mahle	Replaces Pi4230 SMXVST25	PR2867Q	MP Filtri	Replaces CU350P10VN	943816Q
Mahle	Replaces Pi4245 SMXVST25	PR2875Q	MP Filtri	Replaces CU350P25VN	943816Q
Mahle	Replaces Pi71004DN SMXVST3	PR4520Q	MP Filtri	Replaces CU630A03VN	943817Q
Mahle	Replaces Pi71006DN SMXVST3	PR4524Q	MP Filtri	Replaces CU630A06VN	943818Q
Mahle	Replaces Pi71010DN SMXVST3	PR4528Q	MP Filtri	Replaces CU630A10VN	943819Q
Mahle	Replaces Pi71016DN SMXVST3	PR4532Q	MP Filtri	Replaces CU630A25VN	943820Q
Mahle	Replaces Pi71025DN SMXVST3	PR4536Q	MP Filtri	Replaces CU630M25VN	943820Q
Mahle	Replaces Pi71040DN SMXVST3	PR4540Q	MP Filtri	Replaces CU630P10VN	943820Q
Mahle	Replaces Pi73004DN SMXVST10	PR4521Q	MP Filtri	Replaces CU630P25VN	943820Q
Mahle	Replaces Pi73006DN SMXVST10	PR4525Q	MP Filtri	Replaces CU730A03VN	943821Q
Mahle	Replaces Pi73010DN SMXVST10	PR4529Q	MP Filtri	Replaces CU730A06VN	943822Q
Mahle	Replaces Pi73016DN SMXVST10	PR4533Q	MP Filtri	Replaces CU730A10VN	943823Q
Mahle	Replaces Pi73025DN SMXVST10	PR4537Q	MP Filtri	Replaces CU730A25VN	943824Q
Mahle	Replaces Pi73040DN SMXVST10	PR4541Q	MP Filtri	Replaces CU730M25VN	943824Q
Mahle	Replaces 852 125 SMX 10	939735Q	MP Filtri	Replaces CU730P10VN	943824Q
MP Filtri	Replaces CSG-50-A10-A	928763	MP Filtri	Replaces CU730P25VN	943824Q
MP Filtri	Replaces CSG-50-A25-A	928764	MP Filtri	Replaces CU850A03VN	943825Q
MP Filtri	Replaces CU025A03VN	943793Q	MP Filtri	Replaces CU850A06VN	943826Q
MP Filtri	Replaces CU025A06VN	943794Q	MP Filtri	Replaces CU850A10VN	943827Q
MP Filtri	Replaces CU025A10VN	943795Q	MP Filtri	Replaces CU850A25VN	943828Q
MP Filtri	Replaces CU025A25VN	943796Q	MP Filtri	Replaces CU850M25VN	943828Q
MP Filtri	Replaces CU025M25VN	943796Q	MP Filtri	Replaces CU850P10VN	943828Q
MP Filtri	Replaces CU025P10VN	943796Q	MP Filtri	Replaces CU850P25VN	943828Q
MP Filtri	Replaces CU025P25VN	943796Q	MP Filtri	Replaces HP0371A03VN	938321Q
MP Filtri	Replaces CU040A03VN	943797Q	MP Filtri	Replaces HP0371A06VN	938322Q
MP Filtri	Replaces CU040A06VN	943798Q	MP Filtri	Replaces HP0371A10VN	938323Q
MP Filtri	Replaces CU040A10VN	943799Q	MP Filtri	Replaces HP0371A25VN	938324Q
MP Filtri	Replaces CU040A25VN	943800Q	MP Filtri	Replaces HP0371M10VN	938324Q
MP Filtri	Replaces CU040M25VN	943800Q	MP Filtri	Replaces HP0371M25VN	938324Q
MP Filtri	Replaces CU040P10VN	943800Q	MP Filtri	Replaces HP0371P10VN	938324Q
MP Filtri	Replaces CU040P25VN	943800Q	MP Filtri	Replaces HP0371P25VN	938324Q
MP Filtri	Replaces CU100A03VN	943801Q	MP Filtri	Replaces HP0372A03VN	938325Q
MP Filtri	Replaces CU100A06VN	943802Q	MP Filtri	Replaces HP0372A06VN	938326Q
MP Filtri	Replaces CU100A10VN	943803Q	MP Filtri	Replaces HP0372A10VN	938327Q
MP Filtri	Replaces CU100A25VN	943804Q	MP Filtri	Replaces HP0372A25VN	938328Q
MP Filtri	Replaces CU100M25VN	943804Q	MP Filtri	Replaces HP0372M10VN	938328Q

Hydraulic and Lubrication Interchangeable Element Range

Part Numbers

Note: Bold and darker tint panel indicates the item is standard and available to order immediately.

Filter Element Competitor	Filter Element Competitor Part Number	Parker Part Number	Filter Element Competitor	Filter Element Competitor Part Number	Parker Part Number
MP Filtri	Replaces HP0372M25VN	938328Q	MP Filtri	Replaces HP1351P10VN	938344Q
MP Filtri	Replaces HP0372P10VN	938328Q	MP Filtri	Replaces HP1351P25VN	938344Q
MP Filtri	Replaces HP0372P25VN	938328Q	MP Filtri	Replaces HP1352A03VH	943629Q
MP Filtri	Replaces HP0651A03VH	943613Q	MP Filtri	Replaces HP1352A03VN	938345Q
MP Filtri	Replaces HP0651A03VN	938329Q	MP Filtri	Replaces HP1352A06VH	943630Q
MP Filtri	Replaces HP0651A06VH	943614Q	MP Filtri	Replaces HP1352A06VN	938346Q
MP Filtri	Replaces HP0651A06VN	938330Q	MP Filtri	Replaces HP1352A10VH	943631Q
MP Filtri	Replaces HP0651A10VH	943615Q	MP Filtri	Replaces HP1352A10VN	938347Q
MP Filtri	Replaces HP0651A10VN	938331Q	MP Filtri	Replaces HP1352A25VH	943632Q
MP Filtri	Replaces HP0651A25VH	943616Q	MP Filtri	Replaces HP1352A25VN	938348Q
MP Filtri	Replaces HP0651A25VN	938332Q	MP Filtri	Replaces HP1352M10VH	943632Q
MP Filtri	Replaces HP0651M10VH	943616Q	MP Filtri	Replaces HP1352M10VN	938348Q
MP Filtri	Replaces HP0651M10VN	938332Q	MP Filtri	Replaces HP1352M25VH	943632Q
MP Filtri	Replaces HP0651M25VH	943616Q	MP Filtri	Replaces HP1352M25VN	938348Q
MP Filtri	Replaces HP0651M25VN	938332Q	MP Filtri	Replaces HP1352P10VN	938348Q
MP Filtri	Replaces HP0651P10VN	938332Q	MP Filtri	Replaces HP1352P25VN	938348Q
MP Filtri	Replaces HP0651P25VN	938332Q	MP Filtri	Replaces HP1353A03VH	943633Q
MP Filtri	Replaces HP0652A03VH	943617Q	MP Filtri	Replaces HP1353A03VN	938349Q
MP Filtri	Replaces HP0652A03VN	938333Q	MP Filtri	Replaces HP1353A06VH	943634Q
MP Filtri	Replaces HP0652A06VH	943618Q	MP Filtri	Replaces HP1353A06VN	938350Q
MP Filtri	Replaces HP0652A06VN	938334Q	MP Filtri	Replaces HP1353A10VH	943635Q
MP Filtri	Replaces HP0652A10VH	943619Q	MP Filtri	Replaces HP1353A10VN	938351Q
MP Filtri	Replaces HP0652A10VN	938335Q	MP Filtri	Replaces HP1353A25VH	943636Q
MP Filtri	Replaces HP0652A25VH	943620Q	MP Filtri	Replaces HP1353A25VN	938352Q
MP Filtri	Replaces HP0652A25VN	938336Q	MP Filtri	Replaces HP1353M10VH	943636Q
MP Filtri	Replaces HP0652M10VH	943620Q	MP Filtri	Replaces HP1353M10VN	938352Q
MP Filtri	Replaces HP0652M10VN	938336Q	MP Filtri	Replaces HP1353M25VH	943636Q
MP Filtri	Replaces HP0652M25VH	943620Q	MP Filtri	Replaces HP1353M25VN	938352Q
MP Filtri	Replaces HP0652M25VN	938336Q	MP Filtri	Replaces HP1353P10VN	938352Q
MP Filtri	Replaces HP0652P10VN	938336Q	MP Filtri	Replaces HP1353P25VN	938352Q
MP Filtri	Replaces HP0652P25VN	938336Q	MP Filtri	Replaces HP3201A03VH	943637Q
MP Filtri	Replaces HP0653A03VH	943621Q	MP Filtri	Replaces HP3201A03VN	938353Q
MP Filtri	Replaces HP0653A03VN	938337Q	MP Filtri	Replaces HP3201A06VH	943638Q
MP Filtri	Replaces HP0653A06VH	943622Q	MP Filtri	Replaces HP3201A06VN	938354Q
MP Filtri	Replaces HP0653A06VN	938338Q	MP Filtri	Replaces HP3201A10VH	943639Q
MP Filtri	Replaces HP0653A10VH	943623Q	MP Filtri	Replaces HP3201A10VN	938355Q
MP Filtri	Replaces HP0653A10VN	938339Q	MP Filtri	Replaces HP3201A25VH	943640Q
MP Filtri	Replaces HP0653A25VH	943624Q	MP Filtri	Replaces HP3201A25VN	938356Q
MP Filtri	Replaces HP0653A25VN	938340Q	MP Filtri	Replaces HP3201M10VH	943640Q
MP Filtri	Replaces HP0653M10VH	943624Q	MP Filtri	Replaces HP3201M10VN	938356Q
MP Filtri	Replaces HP0653M10VN	938340Q	MP Filtri	Replaces HP3201M25VH	943640Q
MP Filtri	Replaces HP0653M25VH	943624Q	MP Filtri	Replaces HP3201M25VN	938356Q
MP Filtri	Replaces HP0653M25VN	938340Q	MP Filtri	Replaces HP3201P10VN	938356Q
MP Filtri	Replaces HP0653P10VN	938340Q	MP Filtri	Replaces HP3201P25VN	938356Q
MP Filtri	Replaces HP0653P25VN	938340Q	MP Filtri	Replaces HP3202A03VH	943641Q
MP Filtri	Replaces HP1351A03VH	943625Q	MP Filtri	Replaces HP3202A03VN	938357Q
MP Filtri	Replaces HP1351A03VN	938341Q	MP Filtri	Replaces HP3202A06VH	943642Q
MP Filtri	Replaces HP1351A06VH	943626Q	MP Filtri	Replaces HP3202A06VN	938358Q
MP Filtri	Replaces HP1351A06VN	938342Q	MP Filtri	Replaces HP3202A10VH	943643Q
MP Filtri	Replaces HP1351A10VH	943627Q	MP Filtri	Replaces HP3202A10VN	938359Q
MP Filtri	Replaces HP1351A10VN	938343Q	MP Filtri	Replaces HP3202A25VH	943644Q
MP Filtri	Replaces HP1351A25VH	943628Q	MP Filtri	Replaces HP3202A25VN	938360Q
MP Filtri	Replaces HP1351A25VN	938344Q	MP Filtri	Replaces HP3202M10VH	943644Q
MP Filtri	Replaces HP1351M10VH	943628Q	MP Filtri	Replaces HP3202M10VN	938360Q
MP Filtri	Replaces HP1351M10VN	938344Q	MP Filtri	Replaces HP3202M25VH	943644Q
MP Filtri	Replaces HP1351M25VH	943628Q	MP Filtri	Replaces HP3202M25VN	938360Q
MP Filtri	Replaces HP1351M25VN	938344Q	MP Filtri	Replaces HP3202P10VN	938360Q

Hydraulic and Lubrication Interchangeable Element Range



Part Numbers

Note: Bold and darker tint panel indicates the item is standard and available to order immediately.

Filter Element Competitor	Filter Element Competitor Part Number	Parker Part Number	Filter Element Competitor	Filter Element Competitor Part Number	Parker Part Number
MP Filtri	Replaces HP3202P25VN	938360Q	MP Filtri	Replaces HP5003A03VH	943661Q
MP Filtri	Replaces HP3203A03VH	943645Q	MP Filtri	Replaces HP5003A03VN	943516Q
MP Filtri	Replaces HP3203A03VN	943500Q	MP Filtri	Replaces HP5003A06VH	943662Q
MP Filtri	Replaces HP3203A06VH	943646Q	MP Filtri	Replaces HP5003A06VN	943517Q
MP Filtri	Replaces HP3203A06VN	943501Q	MP Filtri	Replaces HP5003A10VH	943663Q
MP Filtri	Replaces HP3203A10VH	943647Q	MP Filtri	Replaces HP5003A10VN	943518Q
MP Filtri	Replaces HP3203A10VN	943502Q	MP Filtri	Replaces HP5003A25VH	943664Q
MP Filtri	Replaces HP3203A25VH	943648Q	MP Filtri	Replaces HP5003A25VN	943519Q
MP Filtri	Replaces HP3203A25VN	943503Q	MP Filtri	Replaces HP5003M10VH	943664Q
MP Filtri	Replaces HP3203M10VH	943648Q	MP Filtri	Replaces HP5003M10VN	943519Q
MP Filtri	Replaces HP3203M10VN	943503Q	MP Filtri	Replaces HP5003M25VH	943664Q
MP Filtri	Replaces HP3203M25VH	943648Q	MP Filtri	Replaces HP5003M25VN	943519Q
MP Filtri	Replaces HP3203M25VN	943503Q	MP Filtri	Replaces HP5003P10VH	943519Q
MP Filtri	Replaces HP3203P10VH	943503Q	MP Filtri	Replaces HP5003P25VN	943519Q
MP Filtri	Replaces HP3203P25VN	943503Q	MP Filtri	Replaces HP5004A03VH	943665Q
MP Filtri	Replaces HP3204A03VH	943649Q	MP Filtri	Replaces HP5004A03VN	943520Q
MP Filtri	Replaces HP3204A03VN	943504Q	MP Filtri	Replaces HP5004A06VH	943666Q
MP Filtri	Replaces HP3204A06VH	943650Q	MP Filtri	Replaces HP5004A06VN	943521Q
MP Filtri	Replaces HP3204A06VN	943505Q	MP Filtri	Replaces HP5004A10VH	943667Q
MP Filtri	Replaces HP3204A10VH	943651Q	MP Filtri	Replaces HP5004A10VN	943522Q
MP Filtri	Replaces HP3204A10VN	943506Q	MP Filtri	Replaces HP5004A25VH	943668Q
MP Filtri	Replaces HP3204A25VH	943652Q	MP Filtri	Replaces HP5004A25VN	943523Q
MP Filtri	Replaces HP3204A25VN	943507Q	MP Filtri	Replaces HP5004M10VH	943668Q
MP Filtri	Replaces HP3204M10VH	943652Q	MP Filtri	Replaces HP5004M10VN	943523Q
MP Filtri	Replaces HP3204M10VN	943507Q	MP Filtri	Replaces HP5004M25VH	943668Q
MP Filtri	Replaces HP3204M25VH	943652Q	MP Filtri	Replaces HP5004M25VN	943523Q
MP Filtri	Replaces HP3204M25VN	943507Q	MP Filtri	Replaces HP5004P10VH	943523Q
MP Filtri	Replaces HP3204P10VH	943507Q	MP Filtri	Replaces HP5004P25VN	943523Q
MP Filtri	Replaces HP3204P25VN	943507Q	MP Filtri	Replaces HP5005A03VH	943669Q
MP Filtri	Replaces HP5001A03VH	943653Q	MP Filtri	Replaces HP5005A03VN	943524Q
MP Filtri	Replaces HP5001A03VN	943508Q	MP Filtri	Replaces HP5005A06VH	943670Q
MP Filtri	Replaces HP5001A06VH	943654Q	MP Filtri	Replaces HP5005A06VN	943525Q
MP Filtri	Replaces HP5001A06VN	943509Q	MP Filtri	Replaces HP5005A10VH	943671Q
MP Filtri	Replaces HP5001A10VH	943655Q	MP Filtri	Replaces HP5005A10VN	943526Q
MP Filtri	Replaces HP5001A10VN	943510Q	MP Filtri	Replaces HP5005A25VH	943672Q
MP Filtri	Replaces HP5001A25VH	943656Q	MP Filtri	Replaces HP5005A25VN	943527Q
MP Filtri	Replaces HP5001A25VN	943511Q	MP Filtri	Replaces HP5005M10VH	943672Q
MP Filtri	Replaces HP5001M10VH	943656Q	MP Filtri	Replaces HP5005M10VN	943527Q
MP Filtri	Replaces HP5001M10VN	943511Q	MP Filtri	Replaces HP5005M25VH	943672Q
MP Filtri	Replaces HP5001M25VH	943656Q	MP Filtri	Replaces HP5005M25VN	943527Q
MP Filtri	Replaces HP5001M25VN	943511Q	MP Filtri	Replaces HP5005P10VH	943527Q
MP Filtri	Replaces HP5001P10VH	943511Q	MP Filtri	Replaces HP5005P25VN	943527Q
MP Filtri	Replaces HP5001P25VN	943511Q	MP Filtri	Replaces MF0301A03VN	943703Q
MP Filtri	Replaces HP5002A03VH	943657Q	MP Filtri	Replaces MF0301A06VN	943704Q
MP Filtri	Replaces HP5002A03VN	943512Q	MP Filtri	Replaces MF0301A10VH	943705Q
MP Filtri	Replaces HP5002A06VH	943658Q	MP Filtri	Replaces MF0301A25VN	943706Q
MP Filtri	Replaces HP5002A06VN	943513Q	MP Filtri	Replaces MF0301M25VN	943706Q
MP Filtri	Replaces HP5002A10VH	943659Q	MP Filtri	Replaces MF0301P10VH	943706Q
MP Filtri	Replaces HP5002A10VN	943514Q	MP Filtri	Replaces MF0301P25VN	943706Q
MP Filtri	Replaces HP5002A25VH	943660Q	MP Filtri	Replaces MF1001A03VN	943707Q
MP Filtri	Replaces HP5002A25VN	943515Q	MP Filtri	Replaces MF1001A06VN	943708Q
MP Filtri	Replaces HP5002M10VH	943660Q	MP Filtri	Replaces MF1001A10VH	943709Q
MP Filtri	Replaces HP5002M10VN	943515Q	MP Filtri	Replaces MF1001A25VN	943710Q
MP Filtri	Replaces HP5002M25VH	943660Q	MP Filtri	Replaces MF1001M25VN	943710Q
MP Filtri	Replaces HP5002M25VN	943515Q	MP Filtri	Replaces MF1001P10VH	943710Q
MP Filtri	Replaces HP5002P10VH	943515Q	MP Filtri	Replaces MF1001P25VN	943710Q
MP Filtri	Replaces HP5002P25VN	943515Q	MP Filtri	Replaces MF1002A03VN	943711Q

Hydraulic and Lubrication Interchangeable Element Range

Part Numbers

Note: Bold and darker tint panel indicates the item is standard and available to order immediately.

Filter Element Competitor	Filter Element Competitor Part Number	Parker Part Number	Filter Element Competitor	Filter Element Competitor Part Number	Parker Part Number
MP Filtri	Replaces MF1002A06VN	943712Q	MP Filtri	Replaces MR1001A25V	938320Q
MP Filtri	Replaces MF1002A10VN	943713Q	MP Filtri	Replaces MR1001M25V	938320Q
MP Filtri	Replaces MF1002A25VN	943714Q	MP Filtri	Replaces MR1001P10V	938320Q
MP Filtri	Replaces MF1002M25VN	943714Q	MP Filtri	Replaces MR1001P25V	938320Q
MP Filtri	Replaces MF1002P10VN	943714Q	MP Filtri	Replaces MR1002A03V	943879Q
MP Filtri	Replaces MF1002P25VN	943714Q	MP Filtri	Replaces MR1002A10V	943880Q
MP Filtri	Replaces MF1003A03VN	943715Q	MP Filtri	Replaces MR1002A25V	943881Q
MP Filtri	Replaces MF1003A06VN	943716Q	MP Filtri	Replaces MR1002M25V	943881Q
MP Filtri	Replaces MF1003A10VN	943717Q	MP Filtri	Replaces MR1002P10V	943881Q
MP Filtri	Replaces MF1003A25VN	943718Q	MP Filtri	Replaces MR1002P25V	943881Q
MP Filtri	Replaces MF1003M25VN	943718Q	MP Filtri	Replaces MR1003A03V	943887Q
MP Filtri	Replaces MF1003P10VN	943718Q	MP Filtri	Replaces MR1003A10V	943888Q
MP Filtri	Replaces MF1003P25VN	943718Q	MP Filtri	Replaces MR1003A25V	943889Q
MP Filtri	Replaces MF1801A03VN	943719Q	MP Filtri	Replaces MR1003M25V	943889Q
MP Filtri	Replaces MF1801A06VN	943720Q	MP Filtri	Replaces MR1003P10V	943889Q
MP Filtri	Replaces MF1801A10VN	943721Q	MP Filtri	Replaces MR1003P25V	943889Q
MP Filtri	Replaces MF1801A25VN	943722Q	MP Filtri	Replaces MR1004A03V	943895Q
MP Filtri	Replaces MF1801M25VN	943722Q	MP Filtri	Replaces MR1004A10V	943896Q
MP Filtri	Replaces MF1801P10VN	943722Q	MP Filtri	Replaces MR1004A25V	943897Q
MP Filtri	Replaces MF1801P25VN	943722Q	MP Filtri	Replaces MR1004M25V	943897Q
MP Filtri	Replaces MF1802A03VN	943723Q	MP Filtri	Replaces MR1004P10V	943897Q
MP Filtri	Replaces MF1802A06VN	943724Q	MP Filtri	Replaces MR1004P25V	943897Q
MP Filtri	Replaces MF1802A10VN	943725Q	MP Filtri	Replaces MR2501A03V	943903Q
MP Filtri	Replaces MF1802A25VN	943726Q	MP Filtri	Replaces MR2501A10V	943904Q
MP Filtri	Replaces MF1802M25VN	943726Q	MP Filtri	Replaces MR2501A25V	943905Q
MP Filtri	Replaces MF1802P10VN	943726Q	MP Filtri	Replaces MR2501M25V	943905Q
MP Filtri	Replaces MF1802P25VN	943726Q	MP Filtri	Replaces MR2501P10V	943905Q
MP Filtri	Replaces MF4001A03VN	943727Q	MP Filtri	Replaces MR2501P25V	943905Q
MP Filtri	Replaces MF4001A06VN	943728Q	MP Filtri	Replaces MR2502A03V	943911Q
MP Filtri	Replaces MF4001A10VN	943729Q	MP Filtri	Replaces MR2502A10V	943912Q
MP Filtri	Replaces MF4001A25VN	943730Q	MP Filtri	Replaces MR2502A25V	943913Q
MP Filtri	Replaces MF4001M25VN	943730Q	MP Filtri	Replaces MR2502M25V	943913Q
MP Filtri	Replaces MF4001P10VN	943730Q	MP Filtri	Replaces MR2502P10V	943913Q
MP Filtri	Replaces MF4001P25VN	943730Q	MP Filtri	Replaces MR2502P25V	943913Q
MP Filtri	Replaces MF4002A03VN	943731Q	MP Filtri	Replaces MR2503A03V	943919Q
MP Filtri	Replaces MF4002A06VN	943732Q	MP Filtri	Replaces MR2503A10V	943920Q
MP Filtri	Replaces MF4002A10VN	943733Q	MP Filtri	Replaces MR2503A25V	943921Q
MP Filtri	Replaces MF4002A25VN	943734Q	MP Filtri	Replaces MR2503M25V	943921Q
MP Filtri	Replaces MF4002M25VN	943734Q	MP Filtri	Replaces MR2503P10V	943921Q
MP Filtri	Replaces MF4002P10VN	943734Q	MP Filtri	Replaces MR2503P25V	943921Q
MP Filtri	Replaces MF4002P25VN	943734Q	MP Filtri	Replaces MR2504A03V	943927Q
MP Filtri	Replaces MF4003A03VN	943735Q	MP Filtri	Replaces MR2504A10V	943928Q
MP Filtri	Replaces MF4003A06VN	943736Q	MP Filtri	Replaces MR2504A25V	943929Q
MP Filtri	Replaces MF4003A10VN	943737Q	MP Filtri	Replaces MR2504M25V	943929Q
MP Filtri	Replaces MF4003A25VN	943738Q	MP Filtri	Replaces MR2504P10V	943929Q
MP Filtri	Replaces MF4003M25VN	943738Q	MP Filtri	Replaces MR2504P25V	943929Q
MP Filtri	Replaces MF4003P10VN	943738Q	MP Filtri	Replaces MR6301A03V	943935Q
MP Filtri	Replaces MF4003P25VN	943738Q	MP Filtri	Replaces MR6301A10V	943936Q
MP Filtri	Replaces MF7501A03VN	943739Q	MP Filtri	Replaces MR6301A25V	943937Q
MP Filtri	Replaces MF7501A06VN	943740Q	MP Filtri	Replaces MR6301M25V	943937Q
MP Filtri	Replaces MF7501A10VN	943741Q	MP Filtri	Replaces MR6301P10V	943937Q
MP Filtri	Replaces MF7501A25VN	943742Q	MP Filtri	Replaces MR6301P25V	943937Q
MP Filtri	Replaces MF7501M25VN	943742Q	MP Filtri	Replaces MR6302A03V	943943Q
MP Filtri	Replaces MF7501P10VN	943742Q	MP Filtri	Replaces MR6302A10V	943944Q
MP Filtri	Replaces MF7501P25VN	943742Q	MP Filtri	Replaces MR6302A25V	943945Q
MP Filtri	Replaces MR1001A03V	938318Q	MP Filtri	Replaces MR6302M25V	943945Q
MP Filtri	Replaces MR1001A10V	938319Q	MP Filtri	Replaces MR6302P10V	943945Q

Hydraulic and Lubrication Interchangeable Element Range



Part Numbers

Note: Bold and darker tint panel indicates the item is standard and available to order immediately.

Filter Element Competitor	Filter Element Competitor Part Number	Parker Part Number
MP Filtri	Replaces MR6302P25V	943945Q
MP Filtri	Replaces MR6303A03V	943951Q
MP Filtri	Replaces MR6303A10V	943952Q
MP Filtri	Replaces MR6303A25V	943953Q
MP Filtri	Replaces MR6303M25V	943953Q
MP Filtri	Replaces MR6303P10V	943953Q
MP Filtri	Replaces MR6303P25V	943953Q
MP Filtri	Replaces MR6304A03V	943959Q
MP Filtri	Replaces MR6304A10V	943960Q
MP Filtri	Replaces MR6304A25V	943961Q
MP Filtri	Replaces MR6304M25V	943961Q
MP Filtri	Replaces MR6304P10V	943961Q
MP Filtri	Replaces MR6304P25V	943961Q
MP Filtri	Replaces MR8501A03V	943967Q
MP Filtri	Replaces MR8501A10V	943968Q
MP Filtri	Replaces MR8501A25V	943969Q
MP Filtri	Replaces MR8501M25V	943969Q
MP Filtri	Replaces MR8501P10V	943969Q
MP Filtri	Replaces MR8501P25V	943969Q
MP Filtri	Replaces MR8502A03V	943975Q
MP Filtri	Replaces MR8502A10V	943976Q
MP Filtri	Replaces MR8502A25V	943977Q
MP Filtri	Replaces MR8502M25V	943977Q
MP Filtri	Replaces MR8502P10V	943977Q
MP Filtri	Replaces MR8502P25V	943977Q
MP Filtri	Replaces MR8503A03V	943983Q
MP Filtri	Replaces MR8503A10V	943984Q
MP Filtri	Replaces MR8503A25V	943985Q
MP Filtri	Replaces MR8503M25V	943985Q
MP Filtri	Replaces MR8503P10V	943985Q
MP Filtri	Replaces MR8503P25V	943985Q
MP Filtri	Replaces MR8504A03V	943991Q
MP Filtri	Replaces MR8504A10V	943992Q
MP Filtri	Replaces MR8504A25V	943993Q
MP Filtri	Replaces MR8504M25V	943993Q
MP Filtri	Replaces MR8504P10V	943993Q
MP Filtri	Replaces MR8504P25V	943993Q
Norman Ultraporous	Replaces U-1005	MX.1518.4.10X4
Palfinger	Replaces EA1673	939724Q
Palfinger	Replaces EA2169	938309Q
Pall	Replaces HC0728FKN26H	938147Q
Pall	Replaces HC0728FKN39H	938151Q
Pall	Replaces HC0728FKP26H	938146Q
Pall	Replaces HC0728FKP39H	938150Q
Pall	Replaces HC0728FKS26H	938148Q
Pall	Replaces HC0728FKS39H	938152Q
Pall	Replaces HC0728FKT26H	938149Q
Pall	Replaces HC0728FKT39H	938153Q
Pall	Replaces HC2253FKN16H	932641Q
Pall	Replaces HC2253FKP16H	932640Q
Pall	Replaces HC2253FKS16H	932642Q
Pall	Replaces HC2254FKP16H	932643Q
Pall	Replaces HC2254FKP8H	932637Q
Pall	Replaces HC2254FKT16H	932645Q
Pall	Replaces HC2254FKT8H	932639Q
Pall	Replaces HC2618FKN18H	933912Q
Pall	Replaces HC2618FKN36H	933919Q

Filter Element Competitor	Filter Element Competitor Part Number	Parker Part Number
Pall	Replaces HC2618FKP18H	934179Q
Pall	Replaces HC2618FKP36H	934180Q
Pall	Replaces HC2618FKS18H	933913Q
Pall	Replaces HC2618FKS36H	933920Q
Pall	Replaces HC2618FKT18H	933914Q
Pall	Replaces HC2618FKT36H	933921Q
Pall	Replaces HC6200FKN8H	938159Q
Pall	Replaces HC6200FKP8H	938158Q
Pall	Replaces HC6200FKS8H	938160Q
Pall	Replaces HC6200FKT8H	938161Q
Pall	Replaces HC6300FKN13H	937112Q
Pall	Replaces HC6300FKN16H	937113Q
Pall	Replaces HC6300FKN26H	937114Q
Pall	Replaces HC6300FKN8H	937115Q
Pall	Replaces HC6300FKP13H	937116Q
Pall	Replaces HC6300FKP16H	937117Q
Pall	Replaces HC6300FKP26H	937118Q
Pall	Replaces HC6300FKP8H	937122Q
Pall	Replaces HC6300FKS13H	937123Q
Pall	Replaces HC6300FKS16H	937124Q
Pall	Replaces HC6300FKS26H	937125Q
Pall	Replaces HC6300FKS8H	937126Q
Pall	Replaces HC6300FKT13H	937127Q
Pall	Replaces HC6300FKT16H	937128Q
Pall	Replaces HC6300FKT26H	937129Q
Pall	Replaces HC6300FKT8H	937130Q
Pall	Replaces HC6400FKN13H	935140
Pall	Replaces HC6400FKN16H	935144
Pall	Replaces HC6400FKN26H	935148
Pall	Replaces HC6400FKN8H	937134Q
Pall	Replaces HC6400FKP13H	935139
Pall	Replaces HC6400FKP16H	935143
Pall	Replaces HC6400FKP26H	935147
Pall	Replaces HC6400FKP8H	937138Q
Pall	Replaces HC6400FKS13H	935141
Pall	Replaces HC6400FKS16H	935145
Pall	Replaces HC6400FKS26H	935149
Pall	Replaces HC6400FKS8H	937142Q
Pall	Replaces HC6400FKT13H	935142
Pall	Replaces HC6400FKT16H	935146
Pall	Replaces HC6400FKT26H	935150
Pall	Replaces HC6400FKT8H	937146Q
Pall	Replaces HC6500FKN13H	935152
Pall	Replaces HC6500FKN16H	935156
Pall	Replaces HC6500FKN26H	935160
Pall	Replaces HC6500FKN8H	PR4346Q
Pall	Replaces HC6500FKP13H	935151
Pall	Replaces HC6500FKP16H	935155
Pall	Replaces HC6500FKP26H	935159
Pall	Replaces HC6500FKP8H	PR4347Q
Pall	Replaces HC6500FKS13H	935153
Pall	Replaces HC6500FKS16H	935157
Pall	Replaces HC6500FKS26H	935161
Pall	Replaces HC6500FKS8H	PR4345Q
Pall	Replaces HC6500FKT13H	935154
Pall	Replaces HC6500FKT16H	935158
Pall	Replaces HC6500FKT26H	935162

Hydraulic and Lubrication Interchangeable Element Range

Part Numbers

Note: Bold and darker tint panel indicates the item is standard and available to order immediately.

Filter Element Competitor	Filter Element Competitor Part Number	Parker Part Number	Filter Element Competitor	Filter Element Competitor Part Number	Parker Part Number
Pall	Replaces HC6500FKT8H	PR4344Q	Pall	Replaces HC8304FKT16H	937171Q
Pall	Replaces HC7400SKN4H	935164	Pall	Replaces HC8304FKT39H	937172Q
Pall	Replaces HC7400SKN8H	935168	Pall	Replaces HC8314FKN16H	934309Q
Pall	Replaces HC7400SKP4H	935163	Pall	Replaces HC8314FKN39H	934122Q
Pall	Replaces HC7400SKP8H	935167	Pall	Replaces HC8314FKP16H	934308Q
Pall	Replaces HC7400SKS4H	935165	Pall	Replaces HC8314FKP39H	934121Q
Pall	Replaces HC7400SKS8H	935169	Pall	Replaces HC8314FKS16H	934310Q
Pall	Replaces HC7400SKT4H	935166	Pall	Replaces HC8314FKS39H	934123Q
Pall	Replaces HC7400SKT8H	935170	Pall	Replaces HC8314FKT16H	934311Q
Pall	Replaces HC7500SKJ4H	937151Q	Pall	Replaces HC8314FKT39H	934124Q
Pall	Replaces HC7500SKN4H	928766	Pall	Replaces HC8400FKN16H	933759Q
Pall	Replaces HC7500SKN8H	932073	Pall	Replaces HC8400FKN26H	933227Q
Pall	Replaces HC7500SKP4H	934200	Pall	Replaces HC8400FKN39H	933090Q
Pall	Replaces HC7500SKS8H	929445	Pall	Replaces HC8400FKN8H	933758Q
Pall	Replaces HC7500SKT4H	928767	Pall	Replaces HC8400FKP16H	933776Q
Pall	Replaces HC7500SKT8H	929446	Pall	Replaces HC8400FKP26H	933226Q
Pall	Replaces HC8200FKN13H	934472Q	Pall	Replaces HC8400FKP39H	933089Q
Pall	Replaces HC8200FKN16H	935549Q	Pall	Replaces HC8400FKP8H	933773Q
Pall	Replaces HC8200FKN8H	932266Q	Pall	Replaces HC8400FKS16H	933777Q
Pall	Replaces HC8200FKP13H	934473Q	Pall	Replaces HC8400FKS26H	933228Q
Pall	Replaces HC8200FKP16H	935548Q	Pall	Replaces HC8400FKS39H	933091Q
Pall	Replaces HC8200FKP8H	933363Q	Pall	Replaces HC8400FKS8H	933774Q
Pall	Replaces HC8200FKS13H	934474Q	Pall	Replaces HC8400FKT16H	933763Q
Pall	Replaces HC8200FKS16H	935550Q	Pall	Replaces HC8400FKT26H	933229Q
Pall	Replaces HC8200FKS8H	933364Q	Pall	Replaces HC8400FKT39H	933092Q
Pall	Replaces HC8200FKT13H	934475Q	Pall	Replaces HC8400FKT8H	933775Q
Pall	Replaces HC8200FKT16H	935551Q	Pall	Replaces HC8500FKN13H	935176
Pall	Replaces HC8200FKT8H	933365Q	Pall	Replaces HC8500FKN26H	935180
Pall	Replaces HC8300FKN16H	PR2798Q	Pall	Replaces HC8500FKN8H	935172
Pall	Replaces HC8300FKN21H	937153Q	Pall	Replaces HC8500FKP13H	935175
Pall	Replaces HC8300FKN39H	932873Q	Pall	Replaces HC8500FKP26H	935179
Pall	Replaces HC8300FKN8H	927861Q	Pall	Replaces HC8500FKP8H	935171
Pall	Replaces HC8300FKP16H	PR3455Q	Pall	Replaces HC8500FKS13H	935177
Pall	Replaces HC8300FKP39H	932872Q	Pall	Replaces HC8500FKS26H	935181
Pall	Replaces HC8300FKP8H	927663Q	Pall	Replaces HC8500FKS8H	935173
Pall	Replaces HC8300FKS16H	PR3456Q	Pall	Replaces HC8500FKT13H	935178
Pall	Replaces HC8300FKS21H	937155Q	Pall	Replaces HC8500FKT26H	935182
Pall	Replaces HC8300FKS26H	937156Q	Pall	Replaces HC8500FKT8H	935174
Pall	Replaces HC8300FKS39H	932874Q	Pall	Replaces HC8700FKN4H	PR4454Q
Pall	Replaces HC8300FKS8H	927661Q	Pall	Replaces HC8700FKN8H	PR4458Q
Pall	Replaces HC8300FKT16H	933047Q	Pall	Replaces HC8700FKP4H	PR4453Q
Pall	Replaces HC8300FKT21H	937157Q	Pall	Replaces HC8700FKP8H	PR4457Q
Pall	Replaces HC8300FKT26H	937158Q	Pall	Replaces HC8700FKS4H	PR4455Q
Pall	Replaces HC8300FKT39H	932875Q	Pall	Replaces HC8700FKS8H	PR4459Q
Pall	Replaces HC8300FKT8H	929099Q	Pall	Replaces HC8700FKT4H	PR4456Q
Pall	Replaces HC8300FKZ16H	937159Q	Pall	Replaces HC8700FKT8H	PR4460Q
Pall	Replaces HC8300FKZ39H	937160Q	Pall	Replaces HC8800FKN13H	933378Q
Pall	Replaces HC8300FKZ8H	937161Q	Pall	Replaces HC8800FKN16H	933234Q
Pall	Replaces HC8300FWT16H	937162Q	Pall	Replaces HC8800FKN8H	933377Q
Pall	Replaces HC8300FWT39H	937163Q	Pall	Replaces HC8800FKP13H	930222Q
Pall	Replaces HC8300FWT8H	937164Q	Pall	Replaces HC8800FKP16H	930226Q
Pall	Replaces HC8304FKN16H	937165Q	Pall	Replaces HC8800FKP8H	930218Q
Pall	Replaces HC8304FKN39H	937166Q	Pall	Replaces HC8800FKS13H	930223Q
Pall	Replaces HC8304FKN16H	937167Q	Pall	Replaces HC8800FKS16H	930227Q
Pall	Replaces HC8304FKN39H	937168Q	Pall	Replaces HC8800FKS8H	930219Q
Pall	Replaces HC8304FKS16H	937169Q	Pall	Replaces HC8800FKT13H	930224Q
Pall	Replaces HC8304FKS39H	937170Q	Pall	Replaces HC8800FKT16H	930228Q

Hydraulic and Lubrication Interchangeable Element Range



Part Numbers

Note: Bold and darker tint panel indicates the item is standard and available to order immediately.

Filter Element Competitor	Filter Element Competitor Part Number	Parker Part Number
Pall	Replaces HC8800FKT8H	930220Q
Pall	Replaces HC8900FKN13H	933203Q
Pall	Replaces HC8900FKN16H	933211Q
Pall	Replaces HC8900FKN26H	933219Q
Pall	Replaces HC8900FKN39H	937180Q
Pall	Replaces HC8900FKN8H	933194Q
Pall	Replaces HC8900FKP13H	933202Q
Pall	Replaces HC8900FKP16H	933210Q
Pall	Replaces HC8900FKP26H	933218Q
Pall	Replaces HC8900FKP39H	937181Q
Pall	Replaces HC8900FKP8H	933193Q
Pall	Replaces HC8900FKS13H	933204Q
Pall	Replaces HC8900FKS16H	933212Q
Pall	Replaces HC8900FKS26H	933220Q
Pall	Replaces HC8900FKS39H	937182Q
Pall	Replaces HC8900FKS8H	933195Q
Pall	Replaces HC8900FKT13H	933205Q
Pall	Replaces HC8900FKT16H	933213Q
Pall	Replaces HC8900FKT26H	933221Q
Pall	Replaces HC8900FKT39H	937183Q
Pall	Replaces HC8900FKT8H	933196Q
Pall	Replaces HC8904FKN13H	944067Q
Pall	Replaces HC8904FKN26H	944071Q
Pall	Replaces HC8904FKN39H	938315Q
Pall	Replaces HC8904FKN8H	944063Q
Pall	Replaces HC8904FKP13H	944066Q
Pall	Replaces HC8904FKP26H	944070Q
Pall	Replaces HC8904FKP39H	938314Q
Pall	Replaces HC8904FKP8H	944062Q
Pall	Replaces HC8904FKS13H	944068Q
Pall	Replaces HC8904FKS26H	944072Q
Pall	Replaces HC8904FKS39H	938316Q
Pall	Replaces HC8904FKS8H	944064Q
Pall	Replaces HC8904FKT13H	944069Q
Pall	Replaces HC8904FKT26H	944073Q
Pall	Replaces HC8904FKT39H	938317Q
Pall	Replaces HC8904FKT8H	944065Q
Pall	Replaces HC9020FKN4H	933239Q
Pall	Replaces HC9020FKN8H	933246Q
Pall	Replaces HC9020FKP4H	925582Q
Pall	Replaces HC9020FKP8H	925602Q
Pall	Replaces HC9020FKS4H	925580Q
Pall	Replaces HC9020FKS8H	925600Q
Pall	Replaces HC9020FKT4H	PR3444Q
Pall	Replaces HC9020FKT8H	PR3446Q
Pall	Replaces HC9020FKZ4H	937184Q
Pall	Replaces HC9021FKP4H	927725Q
Pall	Replaces HC9021FKP8H	927723Q
Pall	Replaces HC9021FKS4H	927696Q
Pall	Replaces HC9021FKT4H	928642Q
Pall	Replaces HC9021FKT8H	928643Q
Pall	Replaces HC9100FKN8H	938163Q
Pall	Replaces HC9100FKP8H	938162Q
Pall	Replaces HC9100FKS8H	938164Q
Pall	Replaces HC9100FKT8H	938165Q
Pall	Replaces HC9300FKN8H	935184
Pall	Replaces HC9300FKP8H	935183

Filter Element Competitor	Filter Element Competitor Part Number	Parker Part Number
Pall	Replaces HC9300FKS8H	935185
Pall	Replaces HC9300FKT8H	935186
Pall	Replaces HC9400FKN13H	929886Q
Pall	Replaces HC9400FKN26H	929892Q
Pall	Replaces HC9400FKN39H	933264Q
Pall	Replaces HC9400FKP13H	929884Q
Pall	Replaces HC9400FKP26H	929890Q
Pall	Replaces HC9400FKP39H	933263Q
Pall	Replaces HC9400FKS13H	929885Q
Pall	Replaces HC9400FKS26H	929891Q
Pall	Replaces HC9400FKS39H	933265Q
Pall	Replaces HC9400FKT13H	933253Q
Pall	Replaces HC9400FKT26H	933258Q
Pall	Replaces HC9400FKT39H	933266Q
Pall	Replaces HC9600FKN13H	926845Q
Pall	Replaces HC9600FKN16H	926890Q
Pall	Replaces HC9600FKN4H	926841Q
Pall	Replaces HC9600FKN8H	926843Q
Pall	Replaces HC9600FKP13H	926698Q
Pall	Replaces HC9600FKP16H	926699Q
Pall	Replaces HC9600FKP4H	PR3435Q
Pall	Replaces HC9600FKP8H	PR3436Q
Pall	Replaces HC9600FKS13H	926839Q
Pall	Replaces HC9600FKS16H	926888Q
Pall	Replaces HC9600FKS4H	PR3437Q
Pall	Replaces HC9600FKS8H	PR3438Q
Pall	Replaces HC9600FKT13H	930162Q
Pall	Replaces HC9600FKT16H	930164Q
Pall	Replaces HC9600FKT4H	PR3440Q
Pall	Replaces HC9600FKT8H	PR3441Q
Pall	Replaces HC9600FWT13H	937186Q
Pall	Replaces HC9601FKN8H	934194Q
Pall	Replaces HC9601FKP13H	927182Q
Pall	Replaces HC9601FKP16H	928143Q
Pall	Replaces HC9601FKP4H	927170Q
Pall	Replaces HC9601FKP8H	927176Q
Pall	Replaces HC9601FKS13H	937187Q
Pall	Replaces HC9601FKS16H	937188Q
Pall	Replaces HC9601FKS4H	937189Q
Pall	Replaces HC9601FKS8H	937190Q
Pall	Replaces HC9601FKT13H	927181Q
Pall	Replaces HC9601FKT16H	928142Q
Pall	Replaces HC9601FKT4H	927169Q
Pall	Replaces HC9601FKT8H	927175Q
Pall	Replaces HC9604FKN13H	937191Q
Pall	Replaces HC9604FKN16H	937192Q
Pall	Replaces HC9604FKN4H	937193Q
Pall	Replaces HC9604FKN8H	937194Q
Pall	Replaces HC9604FKP13H	937197Q
Pall	Replaces HC9604FKP16H	937198Q
Pall	Replaces HC9604FKP4H	937199Q
Pall	Replaces HC9604FKP8H	937200Q
Pall	Replaces HC9604FKS13H	937201Q
Pall	Replaces HC9604FKS16H	937202Q
Pall	Replaces HC9604FKS4H	937203Q
Pall	Replaces HC9604FKS8H	937204Q
Pall	Replaces HC9604FKT13H	937205Q

Hydraulic and Lubrication Interchangeable Element Range

Part Numbers

Note: Bold and darker tint panel indicates the item is standard and available to order immediately.

Filter Element Competitor	Filter Element Competitor Part Number	Parker Part Number
Pall	Replaces HC9604FKT16H	937206Q
Pall	Replaces HC9604FKT4H	937207Q
Pall	Replaces HC9604FKT8H	937208Q
Pall	Replaces HC9650FKN13H	937209Q
Pall	Replaces HC9650FKN16H	926994Q
Pall	Replaces HC9650FKN4H	937210Q
Pall	Replaces HC9650FKN8H	926988Q
Pall	Replaces HC9650FKP13H	937211Q
Pall	Replaces HC9650FKP16H	926998Q
Pall	Replaces HC9650FKP4H	937212Q
Pall	Replaces HC9650FKP8H	926992Q
Pall	Replaces HC9650FKS13H	937213Q
Pall	Replaces HC9650FKS16H	926996Q
Pall	Replaces HC9650FKS4H	937214Q
Pall	Replaces HC9650FKS8H	926990Q
Pall	Replaces HC9650FKT13H	937215Q
Pall	Replaces HC9650FKT16H	933302Q
Pall	Replaces HC9650FKT4H	937216Q
Pall	Replaces HC9650FKT8H	933295Q
Pall	Replaces HC9651FKN16H	937217Q
Pall	Replaces HC9651FKN8H	937218Q
Pall	Replaces HC9651FKP16H	928156Q
Pall	Replaces HC9651FKP8H	928152Q
Pall	Replaces HC9651FKS16H	937219Q
Pall	Replaces HC9651FKS8H	937220Q
Pall	Replaces HC9651FKT16H	928154Q
Pall	Replaces HC9651FKT8H	928150Q
Pall	Replaces HC9700FKN18H	932678Q
Pall	Replaces HC9700FKN27H	933487Q
Pall	Replaces HC9700FKN9H	932669Q
Pall	Replaces HC9700FKN9H	HF41L5VQ
Pall	Replaces HC9700FKP18H	932677Q
Pall	Replaces HC9700FKP27H	933486Q
Pall	Replaces HC9700FKP9H	932668Q
Pall	Replaces HC9700FKP9H	HF41L3VQ
Pall	Replaces HC9700FKS18H	932679Q
Pall	Replaces HC9700FKS27H	933488Q
Pall	Replaces HC9700FKS9H	932670Q
Pall	Replaces HC9700FKS9H	HF41L10VQ
Pall	Replaces HC9700FKT18H	931020Q
Pall	Replaces HC9700FKT27H	933489Q
Pall	Replaces HC9700FKT9H	931018Q
Pall	Replaces HC9700FKT9H	HF41L20VQ
Pall	Replaces HC9800FKN13H	933784Q
Pall	Replaces HC9800FKN4H	930197Q
Pall	Replaces HC9800FKN8H	930198Q
Pall	Replaces HC9800FKP13H	933782Q
Pall	Replaces HC9800FKP4H	930189Q
Pall	Replaces HC9800FKP8H	930192Q
Pall	Replaces HC9800FKS13H	933786Q
Pall	Replaces HC9800FKS4H	930190Q
Pall	Replaces HC9800FKS8H	930193Q
Pall	Replaces HC9800FKT13H	933788Q
Pall	Replaces HC9800FKT4H	930191Q
Pall	Replaces HC9800FKT8H	930194Q
Pall	Replaces HC9801FKP13H	PR2759Q
Pall	Replaces HC9801FKP4H	935191Q

Filter Element Competitor	Filter Element Competitor Part Number	Parker Part Number
Pall	Replaces HC9801FKP8H	935193Q
Pall	Replaces HC9801FKP8Z	935193
Pall	Replaces HC9801FKS13H	937221Q
Pall	Replaces HC9801FKS4H	937222Q
Pall	Replaces HC9801FKS8H	937223Q
Pall	Replaces HC9801FKT13H	PR2760Q
Pall	Replaces HC9801FKT4H	935192Q
Pall	Replaces HC9801FKT8H	935194Q
Pall	Replaces HC9801FKT8Z	935194
Pall	Replaces HC9901FKP13H	935195
Pall	Replaces HC9901FKP26H	935197
Pall	Replaces HC9901FKP39H	935199
Pall	Replaces HC9901FKT13H	935196
Pall	Replaces HC9901FKT26H	935198
Pall	Replaces HC9901FKT39H	935200
Pall	Replaces WR8900FON26H	939300Q
Pall	Replaces HC9100FKN13H	944094Q
Pall	Replaces HC9100FKP13H	944093Q
Pall	Replaces HC9100FKS13H	944095Q
Pall	Replaces HC9100FKT13H	944096Q
Pall	Replaces HC9101FKN8H	944087Q
Pall	Replaces HC9101FKP8H	944086Q
Pall	Replaces HC9101FKS8H	944088Q
Pall	Replaces HC9101FKT8H	944089Q
PTI	Replaces F4E-030-BC-B	926543
PTI	Replaces F4E-050-CC-B	926169
PTI	Replaces F4E-051-CC-B	927147
PTI	Replaces F4E-051-DC-B	927148
PTI	Replaces P83-100-EF-B	929103
PTI	Replaces P83-150-EF-B	929109
PTI	Replaces P83-250-EF-B	932006
PTI	Replaces PG-015-GH	935217
PTI	Replaces PG-015-GU	935220
PTI	Replaces PG-015-HH	935218
PTI	Replaces PG-015-HU	935221
PTI	Replaces PG-015-JH	935219
PTI	Replaces PG-015-JU	935222
PTI	Replaces PG-025-GH	935223
PTI	Replaces PG-025-GU	935226
PTI	Replaces PG-025-HH	935224
PTI	Replaces PG-025-HU	935227
PTI	Replaces PG-025-JH	935225
PTI	Replaces PG-025-JU	935228
PTI	Replaces PG-030-GH	935229
PTI	Replaces PG-030-GU	935232
PTI	Replaces PG-030-HH	935230
PTI	Replaces PG-030-HU	935233
PTI	Replaces PG-030-JH	935231
PTI	Replaces PG-030-JU	935234
PTI	Replaces PG-050-GH	935235
PTI	Replaces PG-050-GU	935238
PTI	Replaces PG-050-HH	935236
PTI	Replaces PG-050-HU	935239
PTI	Replaces PG-050-JH	935237
PTI	Replaces PG-050-JU	935240
PTI	Replaces PG-080-GH	935241
PTI	Replaces PG-080-GU	935244

Hydraulic and Lubrication Interchangeable Element Range



Part Numbers

Note: Bold and darker tint panel indicates the item is standard and available to order immediately.

Filter Element Competitor	Filter Element Competitor Part Number	Parker Part Number
PTI	Replaces PG-080-HH	935242
PTI	Replaces PG-080-HU	935245
PTI	Replaces PG-080-JH	935243
PTI	Replaces PG-080-JU	935246
PTI	Replaces PG-120-GH	935247
PTI	Replaces PG-120-GU	935250
PTI	Replaces PG-120-HH	935248
PTI	Replaces PG-120-HU	935251
PTI	Replaces PG-120-JH	935249
PTI	Replaces PG-120-JU	935252
Schroeder	Replaces 7EZ10	936738
Schroeder	Replaces 8T10	930114
Schroeder	Replaces A10	926567
Schroeder	Replaces A25	926568
Schroeder	Replaces A3	926566
Schroeder	Replaces AAS25	935117
Schroeder	Replaces AAS7	935116
Schroeder	Replaces AAZ3	935115
Schroeder	Replaces AS25	935114
Schroeder	Replaces AZ10	935113
Schroeder	Replaces AZ3	935112
Schroeder	Replaces BBZ10	935122
Schroeder	Replaces BBZ25	935123
Schroeder	Replaces BBZ3/BBZ5	935121
Schroeder	Replaces CCZ10	935128
Schroeder	Replaces CCZ25	935129
Schroeder	Replaces CCZ3	935127
Schroeder	Replaces CCZX3	934978
Schroeder	Replaces CZ10	935125
Schroeder	Replaces CZ25	935126
Schroeder	Replaces CZ3	935124
Schroeder	Replaces DDS25	935135
Schroeder	Replaces DDS7	935134
Schroeder	Replaces DDZ3	935133
Schroeder	Replaces DS25	935132
Schroeder	Replaces DS3	935130
Schroeder	Replaces DS7	935131
Schroeder	Replaces J10	926557
Schroeder	Replaces J25	926558
Schroeder	Replaces J3	926556
Schroeder	Replaces JZ10	935137
Schroeder	Replaces JZ25	935138
Schroeder	Replaces JZ3	935136
Schroeder	Replaces K10	925520
Schroeder	Replaces K25	925773
Schroeder	Replaces K3	925772
Schroeder	Replaces KM74	925776
Schroeder	Replaces KXS3	932674Q
Schroeder	Replaces KW	930156
Schroeder	Replaces KZX10	932676Q
Schroeder	Replaces N10	936178
Schroeder	Replaces NNZX3	941461
Schroeder	Replaces SKB-1	936547
Schroeder	Replaces SKB-1 1/4	936548
Schroeder	Replaces SKB-2	936550
Schroeder	Replaces SKB-3	936551
Schroeder	Replaces 39QM150V	941697
Schroeder	Replaces 39QM60V	941698
Schroeder	Replaces 9V5Z10	941724Q
Schroeder	Replaces KM25	941723
Schroeder	Replaces NNZX25	941725Q
Separation Technologies	Replaces ST6504	929323
Separation Technologies	Replaces ST6505	929324
Separation Technologies	Replaces ST6728	929310
Separation Technologies	Replaces ST6729	929322
Separation Technologies	Replaces ST7040	925582
Separation Technologies	Replaces ST7043	925385
Separation Technologies	Replaces ST7047	925394
Separation Technologies	Replaces ST7338	925792
Separation Technologies	Replaces ST7339	925793
Separation Technologies	Replaces ST7708	901106
Separation Technologies	Replaces ST7709	901473

Filter Element Competitor	Filter Element Competitor Part Number	Parker Part Number
Separation Technologies	Replaces ST7710	901493
Separation Technologies	Replaces ST7711	901494
Separation Technologies	Replaces ST7712	901535
Separation Technologies	Replaces ST7713	901536
Separation Technologies	Replaces ST7714	901619
Separation Technologies	Replaces ST7715	901620
Separation Technologies	Replaces ST7717	901826
Separation Technologies	Replaces ST7718	901856
Separation Technologies	Replaces ST7719	901857
Separation Technologies	Replaces ST7720	906460
Separation Technologies	Replaces ST7721	906461
Separation Technologies	Replaces ST7722	907088
Separation Technologies	Replaces ST7723	907090
Separation Technologies	Replaces ST7726	908642
Separation Technologies	Replaces ST7727	908643
Separation Technologies	Replaces ST7730	909293
Separation Technologies	Replaces ST7732	909299
Separation Technologies	Replaces ST7733	920022
Separation Technologies	Replaces ST7734	920523
Separation Technologies	Replaces ST7735	921085
Separation Technologies	Replaces ST7737	922623
Separation Technologies	Replaces ST7740	922627
Separation Technologies	Replaces ST7741	922661
Separation Technologies	Replaces ST7742	922671
Separation Technologies	Replaces ST7743	922785
Separation Technologies	Replaces ST7745	922789
Separation Technologies	Replaces ST7746	922793
Separation Technologies	Replaces ST7747	922932
Separation Technologies	Replaces ST7748	922933
Separation Technologies	Replaces ST7749	922938
Separation Technologies	Replaces ST7750	922955
Separation Technologies	Replaces ST7751	922972
Separation Technologies	Replaces ST7752	922973
Separation Technologies	Replaces ST7753	922978
Separation Technologies	Replaces ST7754	922991
Separation Technologies	Replaces ST7755	922993
Separation Technologies	Replaces ST7756	923007
Separation Technologies	Replaces ST7757	923008
Separation Technologies	Replaces ST7758	923009
Separation Technologies	Replaces ST7759	923012
Separation Technologies	Replaces ST7760	923013
Separation Technologies	Replaces ST7761	923035
Separation Technologies	Replaces ST7762	923041
Separation Technologies	Replaces ST7763	923047
Separation Technologies	Replaces ST7765	924448
Separation Technologies	Replaces ST7770	924455
Separation Technologies	Replaces ST7771	924456
Separation Technologies	Replaces ST7772	924500
Separation Technologies	Replaces ST7773	924730
Separation Technologies	Replaces ST7775	924734
Separation Technologies	Replaces ST7777	924738
Separation Technologies	Replaces ST7778	924739
Separation Technologies	Replaces ST7779	924790
Separation Technologies	Replaces ST7785	924797
Separation Technologies	Replaces ST7786	924798
Separation Technologies	Replaces ST7787	925036
Separation Technologies	Replaces ST7788	925037
Separation Technologies	Replaces ST7790	925052
Separation Technologies	Replaces ST7791	925572
Separation Technologies	Replaces ST7792	925576
Separation Technologies	Replaces ST7794	925771
Separation Technologies	Replaces ST7795	925835
Separation Technologies	Replaces ST7799	926856
Separation Technologies	Replaces ST7800	927092
Separation Technologies	Replaces ST7801	927093
Separation Technologies	Replaces ST7802	927267
Separation Technologies	Replaces ST7803	927268
Separation Technologies	Replaces ST7804	927269
Separation Technologies	Replaces ST7805	927584
Separation Technologies	Replaces ST7807	932634Q
Separation Technologies	Replaces ST7809	932636Q
Separation Technologies	Replaces ST7810	987141

Marine PAR◇FIT™

Interchangeable Element Range



The marine replacement solution

New to the **PAR◇FIT™** family is a range of Marine Parfit Elements for a number of the most popular marine element competitors. Every Marine **PAR◇FIT™** element is manufactured in Europe to the highest standards and is backed by our unrivalled technical support.

You can reduce stockholdings, cut costs and be sure of the ultimate performance. Parfit filters are available from ParkerStores and authorised distributors throughout Europe.

www.parker.com/parfit
www.parkerhfde.com/parfit



Contact Information:

Parker Hannifin
Hydraulic Filter Division Europe

European Product Information Centre
Freephone: 00800 27 27 5374
(from AT, BE, CH, CZ, DE, EE, ES, FI, FR, IE, IT, PT, SE, SK, UK)
filtrationinfo@parker.com

www.parker.com/hfde

Typical Applications:

- Industrial power units
- Central lubrication systems
- Diesel engine lubrication
- Marine fuel systems
- Power plants
- Gearboxes
- Wind turbines

FEATURES	ADVANTAGES	BENEFITS
Microglass III replacement elements	Multi-layered design producing high dirt holding capacity and high efficiency	Great performance value
	Wire support reduces pleat bunching and keeps performance consistent	Reliable performance throughout element life
		Reduces downtime and maximizes element life
Coreless Ecoglass III replacement elements	No metal content in element	Environmentally friendly disposal by incineration
	Reduced overall weight of 50%	Lower element replacement costs
	Easy compaction of used elements	Lower disposal costs
	Eco adaptors available	Retrofit coreless design to housings already installed
Complete performance data disclosure	All pertinent information is provided in an easy to compare format	No hidden deficiencies
		Easy selection of correct interchange part number
Elements manufactured to exacting standards of original elements	Performance guarantee as good if not better than original fit	Durable, rugged and reliable construction with high quality standards

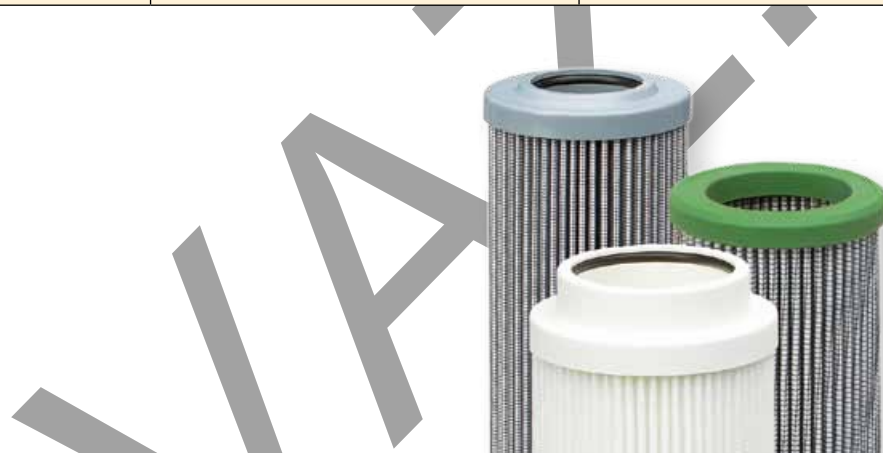

Filter Element Competitor	Filter Element Competitor Part Number	Parker Part Number
Boll and Kirch	1143103	939319Q
Boll and Kirch	1174632 (11843 GEW.300/250 h=230, 37um)	939317Q
Boll and Kirch	1174804 (11843 GEW.300/40)	939312Q
Boll and Kirch	1179995 (11844 GEW.300/40)	939311Q
Boll and Kirch	1340006 (660-63 filter candle pleated 10 um)	939307Q
Boll and Kirch	1340009 (250-40 filter candle 25 um)	939305Q
Boll and Kirch	1340079 (294-31 filter candle 34 um)	939306Q
Boll and Kirch	1940971 (11443 GEW.324/34)	939310Q
Boll and Kirch	1940990 (11513 GEW.275/34)	939309Q
Boll and Kirch	1942562 (11445 GEW.155/100)	939318Q
Boll and Kirch	1943048 (11531 GEW.205/34)	939308Q
Boll and Kirch	1945279 (11531 GEW.205/40)	939314Q
Boll and Kirch	1946344 (11445 GEW.155/40)	939313Q
Boll and Kirch	1947342 (Ø=85, h=244, 40um)	939316Q
Boll and Kirch	1949798 (Ø=85, h=195, 40um)	939315Q
Boll and Kirch	7605706 (Flushing oil element 6.61.07 GR10-15, h=508+36)	939329Q
Boll and Kirch	7608089 (Flushing oil element 6.61.07 GR20, h=760+36)	939330Q

More part numbers on the next page.

Marine PAR◊FIT™

Filter Element Competitor	Filter Element Competitor Part Number	Parker Part Number
Mann and Hummel	BF-1018/1	939332Q
Mann and Hummel	H-1081	939321Q
Mann and Hummel	H-12178	939323Q
Mann and Hummel	H-12225	939324Q
Mann and Hummel	H-15111/2	939338Q
Mann and Hummel	H-15190	939331Q
Mann and Hummel	H-15222/2	939333Q
Mann and Hummel	H-18300	939327Q
Mann and Hummel	H-20211	939335Q
Mann and Hummel	H-25444	939334Q
Mann and Hummel	H-25595	939326Q
Mann and Hummel	H-25669	939325Q
Mann and Hummel	H-28545	939336Q
Mann and Hummel	H-601/4	939320Q
Mann and Hummel	H-930	939328Q
Mann and Hummel	P-19185	939337Q
Pall	HC8300FKN16H	PR2798Q
Pall	HC8300FKN26H	939340Q
Pall	HC8300FKN39H	932873Q
Pall	HC8300FKP16H	PR3455Q
Pall	HC8300FKP26H	939339Q
Pall	HC8300FKP39H	932872Q
Pall	HC8300FKS16H	PR3456Q
Pall	HC8300FKS26H	937156Q
Pall	HC8300FKS39H	932874Q
Pall	HC8300FKT16H	933047Q
Pall	HC8300FKT26H	937158Q
Pall	HC8300FKT39H	932875Q
Pall	HC8304FKN16H	937165Q
Pall	HC8304FKN39H	937166Q
Pall	HC8304FKP16H	937167Q
Pall	HC8304FKP39H	937168Q
Pall	HC8304FKS16H	937169Q
Pall	HC8304FKS39H	937170Q
Pall	HC8304FKT16H	937171Q
Pall	HC8304FKT39H	937172Q
Vokes	B-62982	939303Q
Vokes	B-6358174	939301Q
Vokes	C-6352910	939322Q
Vokes	C-6360352	939304Q
Vokes	C-F7	939302Q

Static control filter elements

Filtration technology improving
safety and oil life time



Static-free is a promise difficult to fulfil

It is not only a filter - the overall portfolio of system components, circuit layout, oil brand and type and environmental conditions have an important influence on the electro-static process in systems and if it occurs to a level that can cause damage.

Parker Static Control Media is an effective method of reducing the overall impact of the electro-static process. **For a static free solution, the complete system and its environment needs to be considered and evaluated, not just the filter in isolation.**

Parker Filtration offers support with analysis of the system oil, wear & tear on system components and the condition of the filter elements.



Contact Information: Parker Advantages:

Parker Hannifin
Hydraulic Filter Division Europe

**European Product
Information Centre**
Freephone: 00800 27 27 5374
(from AT, BE, CH, CZ, DE, EE, ES,
FI, FR, IE, IT, PT, SE, SK, UK)
filtrationinfo@parker.com

www.parker.com/hfde

- Parker Static Control Filter media supports the reduction of varnish sealed in an oil system.
- Parker Static Control elements typically extend the oil life time.
- Using Parker Static Control Filter elements offers end-users no compromise in efficiency, dirt holding capacity or flow pressure drop.
- No vessel modifications are required.
- A 'drop-in' solution for system designers and maintenance engineers.
- Available in a wide range of element configurations.

Static-electric charging of oil reduces oil and system life time

Parker is pleased to present new patent-pending solutions to eliminate the negative impact of electro-static charging. Hydraulic fluids can be sensitive to electro-static charging when being pumped through a system or flowing through a fibrous synthetic filter media structure. The particles/molecules in the hydraulic fluid can gain electro-static load. The problem is related to the negative impact of discharging this load.

Electro-static charging can result in a sudden static discharge (sparks in oil) that, as a consequence, creates local micro hot spots in the oil. Like lightning the discharge occurs in milli-seconds and is associated with very high, localised increases in the temperature of the oil. This temperature increase causes damage to the molecular structure of the oil and hence affects its performance. The process of electro-static charging can eventually cause varnishing in the system.

Example of holes burned in the filter media



Because the discharge often occurs directly downstream of the filter element, the sparks can burn holes in the filter media. This directly influences the filter efficiency.

Fluid with good conductivity

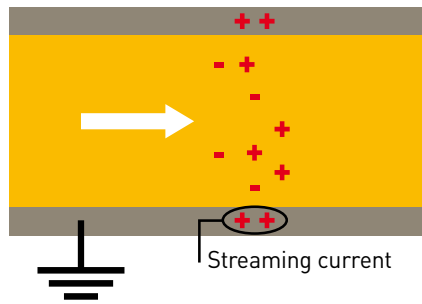

Electro-static charging can occur anywhere in the system. A conductive fluid is able to prevent the local accumulation of electro-static charge. In various components connected to earth a streaming current can be measured.

Fluid with reduced conductivity

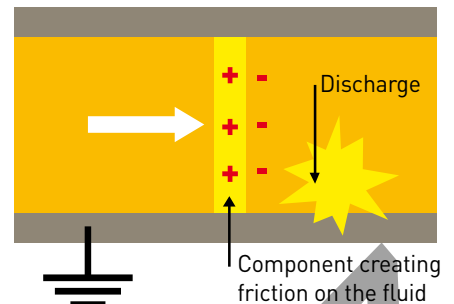

When the fluid conductivity is too low, the amount of Electro-static energy can achieve a level which is sufficient to create a sudden discharge. Just as a balloon can accumulate a specific volume of air, the lower the fluid conductivity the more electro-static energy can build up before a discharge (sparks in the oil) occurs.

Impact of oil groups

Differences amongst the base oil groups can have an impact on the presence of the electro-static discharge process in systems.

Group I oils usually apply a mixture of different hydrocarbon chains with limited or no uniformity. Typically these oils are used in basic applications.

Group II and III oils are in general more applied for demanding applications. **The lower zinc content can have a negative impact on the fluid conductivity.** Group III oils are commonly mixed with additives and positioned as synthetic or semi-synthetic oils. Oil manufacturers can decide to add additives to improve the fluid conductivity.

Group IV are more often applied for automotive and industrial applications, using chemical engineered base stocks like Polyalphaolefins (PAO's).

Group V includes Esters and Polyolesters, these are not used as base oils but added to other base oils. This influences the conductivity amongst the oils covered by this group.

Static-free is a promise difficult to fulfil

The electro-static phenomena can occur anywhere in the system. A filter can generate static electricity but other system components such as pumps, valves, hoses and piping can as well.

The parameters influencing the electro-static phenomena are mainly:

- Type of oil
- Oil temperature
- Air content of the oil
- Relaxation time of the oil in the hydraulic reservoir
- Fluid velocity in the system
- Electro-static energy created by components with rotating parts
- Conductivity & earthing of hoses and piping
- Weather conditions (not mathematically defined)

Table I: Typical element properties by oil group

	Group	I	II	III	IV	V
Element	P	+/- 0,05%	<0,05%	+/- 0,02%	Not included	Not included
Element	Zn	+/- 0,08%	<0,03%	<0,03%	Not included	Not included
Element	S	>0,03%	<0,03%	<0,03%	Not included	Not included
Viscosity Index	VI	80-120	80-120	>120	Not included	Not included
Saturation	%	<90%	>90%	>90%	Not included	Not included

Note: All given values are indicative

Studies have been conducted and these suggest that varnish is formed due to the thermal degradation and oxidisation of the hydraulic oil. The discharge process in the oil can create thermal degradation of the oil. In addition to this, the discharge process can cause pitting of component surfaces.

Varnish can cause system damage and lower system productivity by:

- Varnish build-up on surfaces, blocking flow path of components like heat exchangers
- Causing sticking (servo-) valves
- Slower response of system components with moving parts
- Plugging filters

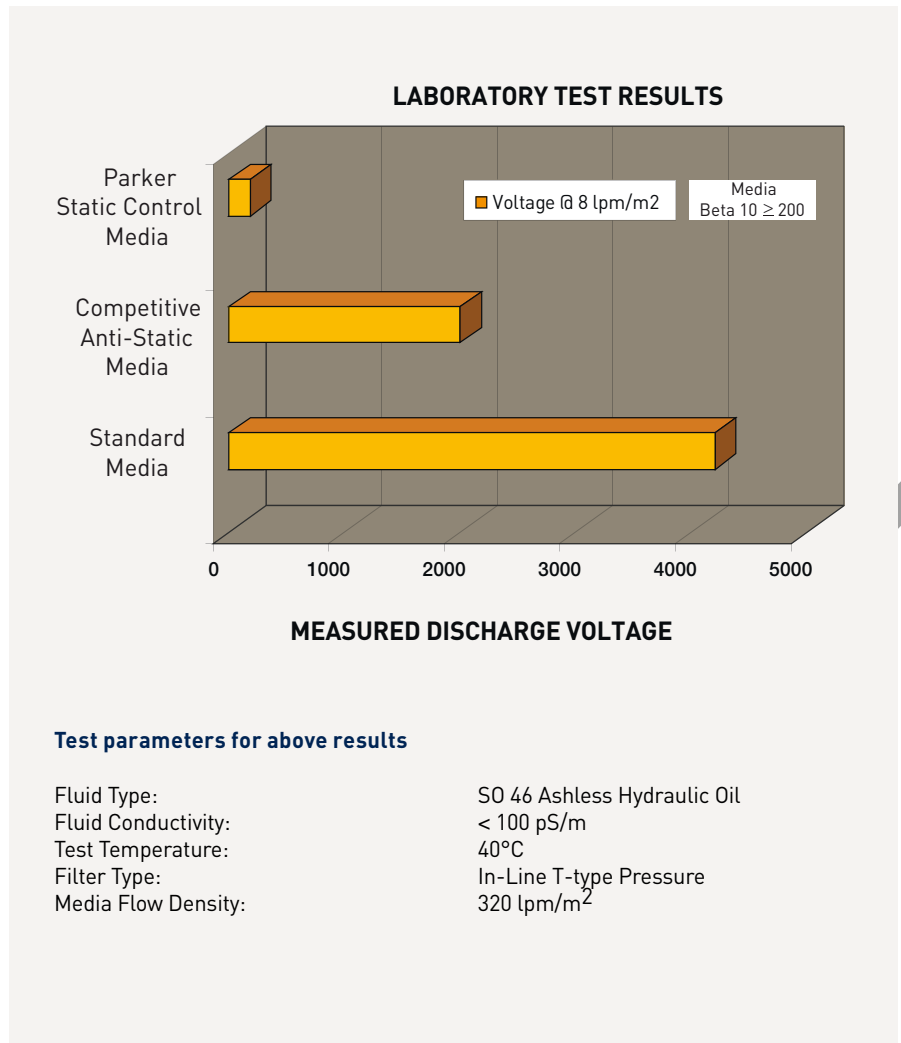

Varnish can block flow channels or cause 'stick-effect' in valves

Varnish is attracted to metal surfaces, the result is an overall decrease in productivity.

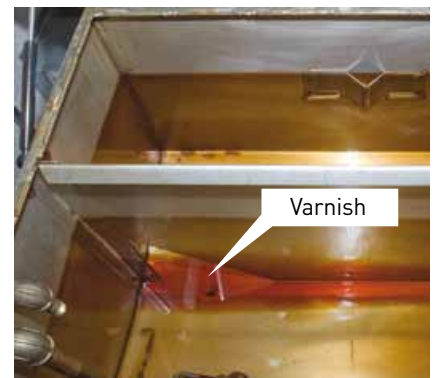
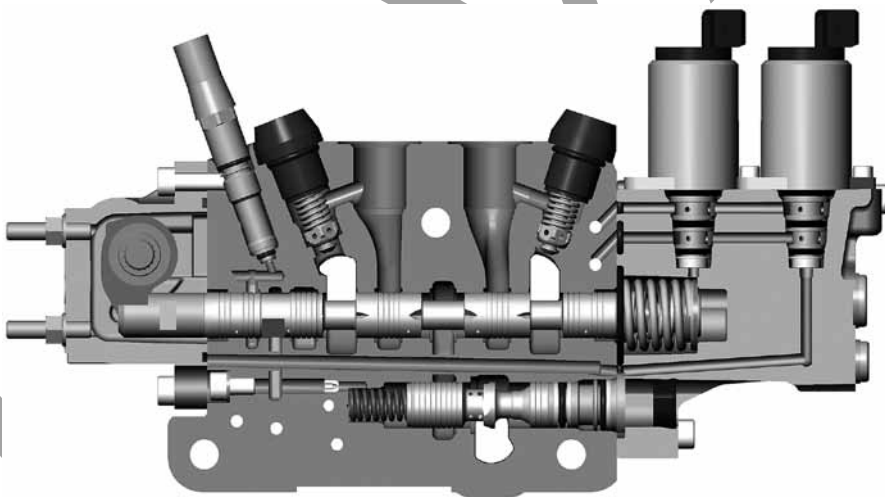

Parker filters available with static control media

TTF Series

Tanktop Mounted Return Line Filters, Max 500 l/min - 10 bar

- Aluminium filter head housing
- In-to-out flow
- ATEX certified version available
- Multiple - return ports (on request)



15/40/80CN Series

Medium Pressure Filters, Max 600 l/min - 70 bar

- Aluminium filter head housing
- In-to-out flow
- ATEX certified version available
- Multiple - return ports (on request)



STF Series

Tanktop Mounted Return Line Filters, Max 500 l/min - 10 bar

- Steel filter housing
- In-to-out flow
- ATEX certified version available
- Multiple - return ports (on request)



EPF iprotect® (Ecological Pressure Filter)

High Pressure Filters, Max 700 l/min - 450 bar

- Steel filter housing
- Patented filter element and reduction of waste typically over 50%
- Reduced surface area
- ATEX certified version available



BGT Series

Tanktop Mounted Return Line Filters, Max 2400 l/min - 10 bar

- Aluminium filter housing
- In-to-out flow
- ATEX certified version available
- Multiple - return ports (on request)



Other filter types available on request.

Ordering Information

TTF Series

Part Number	Flow L/min	Bypass	Ports	Included Options	Micron Rating Bx(c)>200	Replacement Element Part Numbers
TTF302ABP2EG121	90	1.5 bar	G¾	None	2	937750A
TTF310ABP2EG121	90	1.5 bar	G¾	None	10	937786A
TTF602ABP2EG203	170	1.5 bar	G1¼	Diffuser type T	2	937747A
TTF610ABP2EG203	170	1.5 bar	G1¼	Diffuser type T	10	937783A
TTF802ABP2EG243	300	1.5 bar	G1¼	Diffuser type T	2	937745A
TTF810ABP2EG243	300	1.5 bar	G1¼	Diffuser type T	10	937781A
TTF1002ABP2HG24A	500	2.0 bar	G1½	Diffuser type T	2	937743A
TTF1010ABP2HG24A	500	2.0 bar	G1½	Diffuser type T	10	938010A

STF Series

Part Number	Flow L/min	Bypass	Ports	Included Options	Micron Rating Bx(c)>200	Replacement Element Part Numbers
STF802ABP2ELC24G	300	1.5 bar	1½" SAE-flange	Airtight funnel type T	2	937745A
STF810ABP2ELC24G	300	1.5 bar	1½" SAE-flange	Airtight funnel type T	10	937781A
STF1002ABP2ELC24G	500	1.5 bar	1½" SAE-flange	Airtight funnel type T	2	937743A
STF1010ABP2ELC24G	500	1.5 bar	1½" SAE-flange	Airtight funnel type T	10	938010A



Ordering Information

BGT Series

Part Number	Flow L/min	Bypass	Ports	Included Options	Micron Rating Bx(c)>200	Replacement Element Part Numbers
BGT1202ABPER323	500	1.5 bar	2" SAE-3000-PSI	Diffuser type T	2	937741A
BGT1210ABPER323	500	1.5 bar	2" SAE-3000-PSI	Diffuser type T	10	937777A
BGT1502ABPER483	1000	1.5 bar	3" SAE-3000-PSI	Diffuser type T	2	937738A
BGT1510ABPER483	1000	1.5 bar	3" SAE-3000-PSI	Diffuser type T	10	937774A
BGT1702QBPER483	2000	1.5 bar	3" SAE-3000-PSI	Diffuser type T	2	937736A
BGT1710QBPER483	2000	1.5 bar	3" SAE-3000-PSI	Diffuser type T	10	937772A

15/40/80C N Series

Part Number	Flow L/min	Bypass	Ports	Included Options	Micron Rating Bx(c)>200	Replacement Element Part Numbers
15CN102AVPKG164	50	3.5 bar	G1"	none	2	932610A
15CN110AVPKG164	50	3.5 bar	G1"	none	10	932612A
15CN202AVPKG164	100	3.5 bar	G1"	none	2	932616A
15CN210AVPKG164	100	3.5 bar	G1"	none	10	932618A
40CN102AVPKG244	180	3.5 bar	G1½"	none	2	926716A
40CN110AVPKG244	180	3.5 bar	G1½"	none	10	926836A
40CN202AVPKG244	280	3.5 bar	G1½"	none	2	926717A
40CN210AVPKG244	280	3.5 bar	G1½"	none	10	926838A
80CN102APVKG324	370	3.5 bar	G2"	none	2	932659A
80CN110APVKG324	370	3.5 bar	G2"	none	10	932661A
80CN202AVPKG324	530	3.5 bar	G2"	none	2	932665A
80CN210AVPKG324	530	3.5 bar	G2"	none	10	932667A

EPF iprotect (Ecological Pressure Filter)

Part Number	Flow L/min	Micron Rating	Bypass	Ports	Micron Rating Bx(c)>200	Replacement Element Part Numbers
EPF1102AIBPMG081	40	2	7 bar	G½"	2	944418A
EPF1110AIBPMG081	40	10	7 bar	G½"	10	944420A
EPF2202AIBPMG121	140	2	7 bar	G¾"	2	944430A
EPF2210AIBPMG121	140	10	7 bar	G¾"	10	944432A
EPF3202AIBPMG161	250	2	7 bar	G1"	2	944438A
EPF3210AIBPMG161	250	10	7 bar	G1"	10	944440A
EPF4202AIBPMG201	450	2	7 bar	G1¼"	2	944446A
EPF4210AIBPMG201	450	10	7 bar	G1¼"	10	944448A
EPF5102AIBPMG241	500	2	7 bar	G1½"	2	944450A
EPF5110AIBPMG241	500	10	7 bar	G1½"	10	944452A

WARNING

FAILURE OR IMPROPER SELECTION OR IMPROPER USE OF THE PRODUCTS AND/OR SYSTEMS DESCRIBED HEREIN OR RELATED ITEMS CAN CAUSE DEATH, PERSONAL INJURY AND PROPERTY DAMAGE.

This document and other information from Parker Hannifin Corporation, its subsidiaries and authorised distributors provide product and/or system options for further investigation by users having technical expertise. It is important that you analyse all aspects of your application, including consequences of any failure, and review the information concerning the product or system in the current product catalogue. Due to the variety of operating conditions and applications for these products or systems, the user, through their own analysis and testing, is solely responsible for making the final selection of the products and systems and assuring that all performance, safety and warning requirements of the application are met.

The products described herein, including without limitation, product features, specifications, designs, availability and pricing, are subject to change by Parker Hannifin Corporation and its subsidiaries at any time without notice. **Offer of Sale** Please contact your Parker representation for a detailed "Offer of Sale".

The Par-Gel Filter

Water Removal Filter Elements



Stopping free water causing system damage

Increases system efficiency and machine productivity

The Par-Gel filter elements are an effective tool in controlling water related problems in hydraulic power and lubrication systems. Increases system efficiency and machine productivity and reduces the chance of catastrophic system failure.



Contact Information:

Parker Hannifin
Hydraulic Filter Division Europe

European Product Information Centre
Freephone: 00800 27 27 5374
(from AT, BE, CH, CZ, DE, EE, ES, FI, FR, IE, IT, PT, SE, SK, UK)
filtrationinfo@parker.com

www.parker.com/hfde

Product Features:

- Par-Gel elements control water related problems in hydraulic power and lubrication systems.
- Helps reduce component wear and system downtime.
- Increases system efficiency and machine productivity.
- Reduces the chance of catastrophic system failure.

The Par-Gel Filter

Water Removal Filter Elements

Par-Gel filter elements are an effective tool in controlling water related problems in hydraulic power and lubrication systems.

There is more to proper fluid maintenance than just removing particulate matter. You need to remove water as well. Parker has developed Par-Gel water removal elements to be used in combination with particulate filters to provide significant benefits.

- Less component wear, consequently less component generated contaminants.
- Significant reduction of costly downtime and replacement of failed components.
- Increased efficiency of the system, thereby improving machine productivity.
- Less frequent replacement and disposal of contaminated fluid.
- Reduced chance of catastrophic failure.



Water as a contaminant.

Whether you used a mineral-base or synthetic fluid, each will have a water saturation point. Above this point, the fluid cannot dissolve or hold any more water. This excessive water is referred to as 'free' or emulsified water. As little as .03% (300 ppm) by volume can saturate an hydraulic fluid. Many mineral-base and synthetic fluids, unless specifically filtered or treated in some way, will contain levels of water above their saturation point.

Water is everywhere!

Storage and handling. Fluids are constantly exposed to water and water vapour while being handled and stored. For instance, outdoor storage of tanks and drums is common. Water settles on top of tanks and drums and infiltrates the container, or is introduced when the container is opened to add or remove fluid.

In-service. Water can get into the system via worn cylinder and actuator seals, or through reservoir openings. Water can come into contact with these entry points through water based cutting fluids or when water and/or steam are used for cleaning.

Specification



Condensation is also a prime water source. As fluid cools in a reservoir, the temperature drop condenses water vapour on interior surfaces, which in turn causes rust. Rust scale in the reservoir eventually becomes particulate contamination in the system.

Microbial growth as a contaminant.

Once water enters a system, growth of micro-organisms begins. Since water is one of the end products of the breakdown of hydrocarbon fluid, once started, the process is somewhat self-sustaining.

Slime is evidence of microbial growth, as is the apparent increase in viscosity of the fluid, obnoxious odour and discoloured fluid. The results are: short fluid life, degraded surface finish and rapid corrosion.

Water generated damage and operating problems.

- Corrosion
- Accelerated abrasive wear
- Bearing fatigue
- Additive breakdown
- Increased acid level
- Viscosity variance
- Electrical conductivity
- Forms of water in fluid
- Dissolved water – below saturation point
- Free water – emulsified or in droplets*.

Water in the system creates oxides, slimes and resins. Corrosion is an obvious by-product and creates further contaminants in the system.

The effect is compounded, as you now have both particulate contaminant and water working together.

The particulate contamination can be as simple as rust flaking from reservoir walls. Anti-wear additives break down in the presence of water and form acids. The combination of water, heat and dissimilar metals encourages galvanic action. Pitted and corroded metal surfaces and finishes result.

Further complications occur as temperature drops and the fluid has less ability to hold water. As the freeze point is reached, ice crystals form, adversely affecting total system function. Operating functions may become slowed or erratic.

Electrical conductivity becomes a problem when water contamination weakens insulating properties of fluid (decreases dielectric kV strength).

Testing your fluid for water.

A simple 'crackle test' will tell you if there is water in your fluid. Simply take a metal dish or spoon with a small amount of fluid. Apply a flame under the container with a match. If bubbles rise and 'crackle' from the point of applied heat, you have free water.



ParTest fluid analysis. For complete analysis, Parker offers Par-Test fluid analysis. Your Parker representative can supply you with a fluid container, mailing carton and appropriate forms to identify your fluid and its use. An independent lab performs complete spectrometric analysis, particle counts, viscosity and water content.

Results are sent directly to the requester.

* Excessive free water must be removed from the system before filtering is attempted. In systems with gross amounts of water (1% to 2% by volume), settling or vacuum dehydration should be considered before using Par-Gel filter elements.

The Par-Gel Filter

Water Removal Filter Elements

Features & Benefits

Removing water.

Using a Par-Gel water removal element is an effective way of removing free water contamination from your hydraulic system. It is highly effective at removing free water from mineral-base and synthetic fluids.

The Par-Gel filter media is a highly absorbent copolymer laminate with an affinity for water. However, hydraulic or lubrication fluid passes freely through it and the water is bonded to the filter media.



Photo above shows 'dry' Par-Gel filter media and the same media swollen with absorbed water.

Parker technology and expertise at your disposal.

Choosing the correct filters can save money and minimise problems caused by particulate and water contaminants in hydraulic and lubricating fluids. Parker provides hard data and advice on choosing from a wide range of filter configurations, flow patterns and flow pressure capabilities.

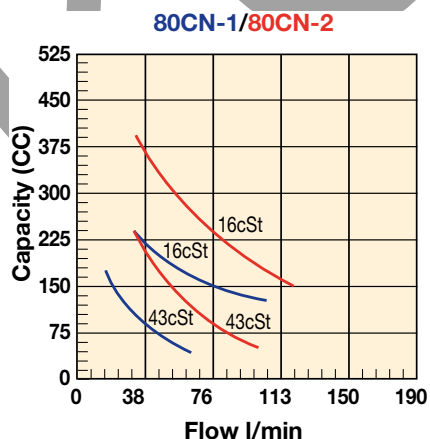

How many filter elements will I need?

Suppose you would like to remove water from contaminated oil stored in a 750 litre tank. The tank is found to have 1000 ppm of water (very contaminated). The circulation rate will be 40 lpm for the 40cSt fluid.

Example: How many single length 80CN elements will be needed to reduce the water to normal saturation levels. To find the answer, use the conversion charts and capacity curves for the 80CN-1 element.

- 1000 ppm start – 300 ppm finish = 700 ppm removed
- 700 ppm water x 0.0001% = .07%
.07% x 750 litres = 0.525 litres water total
- Capacity = 89cc at 40cSt & 40 lpm to pressure drop of 1.7 bar.
89cc per element x 0.001 litres per cc = 0.089 litres per element
- 0.525 litres total water = 6 elements*
0.089 litres per element

* The replacement value of this fluid may range from €1500.00 to €4500.00 (€0.50 to €1.25 litre). An estimated element cost of €150.00 each, the saving could be as much as €3600.00!

Using Par-Gel filter elements saves money in fluid and replacement component costs. Also, the frequency of fluid disposal and the problems associated with it are greatly reduced.

Filter capacity. There are no accepted and approved water capacity testing or reporting standards. Consequently, there is virtually no way to compare one element capacity with another. It is also difficult to simulate a specific application in testing... making it hard to predict field performance.

Why the discrepancies? Water removal media capacity is the result of the interplay of four variables: flow rate, viscosity, bypass setting and the media itself.

Here's an example: two identical elements, testing the same fluid, varying only the flow rate.

This is a 15% reduction in capacity, due to changing only the flow rate! Now, look at what happens when the test flow rate is the same and the viscosity is changed.

	Element A	Element A'
Flow rate:	11 lpm	38 lpm
Viscosity:	15 cSt	15 cSt
Test capacity:	425 ml	360 ml

Twice the capacity can be achieved just by manipulating the test viscosity!

	Element B	Element B'
Flow rate:	76 lpm	76 lpm
Viscosity:	40 cSt	15 cSt
Test capacity:	250 ml	550 ml

Naturally, having a lower bypass valve setting limits the capacity. Since the life of the element is measured in pressure drop, using higher bypass valve settings will increase apparent life (all other conditions equal).

We recommend 1.7 bar bypass valves to get adequate life from Par-Gel filter elements.

Capacity also depends on the media itself. That's why Parker spent two years researching the media used in Par-Gel filter elements. We tested all known media, and worked closely with our suppliers to achieve maximum water absorbency.

Specification

How we report:

Our goal is to give our customers usable data. Why show test results at a lower viscosity (13cSt for example), if the typical application uses 41cSt fluid? So, we report at 41cSt to give typical field application capacity, and 15cSt for competitive comparisons. But keep in mind when comparing, you still have to consider flow rate.

What it all means:

You deserve to know how an element will work for you in your applications. So, we test and report our data in such a way that it helps you predict element performance and life.

Be wary of claims that say... "this element holds one litre (or 5 litres) of water". What was the test flow rate? fluid viscosity? bypass valve setting? Was it run as a 'single pass' or 'multipass' test?

Rely on Parker to give you the facts and data you need. Our goal is to better protect your systems and components...and we start up-front by telling you what you need to know.

Is there any other way to do business?

Add it all up.

Broad selection, competitive prices, off-the-shelf availability, on-time delivery, high-efficiency filter media, reduced system contaminant and longer component life. When you add it all up, we think you'll agree...

Conversion Factors

If you have:	Multiply by:	To get:
mg/l	0.00009	%
ppm	0.0001	%
ml	1.0	cc
gallons	4.54	litres

Typical Saturation Points

Fluid type	PPM	%
Hydraulic	300	0.03
Lubrication	400	0.04
Transformer	50	0.005

Parker Par-Gel water removal filter elements are available in these standard Parker filter housings:

Fluid model series	Length	Element part number
40CN-1	Single	931412
40CN-2	Double	931414
80CN-1	Single	931416
80CN-2	Double	931418
Guardian®	Single	932019
Moduflow RFP 2-2 (10MFP)	Double	940734

Ideal Applications for Par-Gel filter elements



Guardian Portable Filtration System



Filtration Trolley