

# Piloted Non-Return Valves



Piloted non-return valves are designed to protect installations: if the compressed air supply is removed, they lock the air supply to the cylinder, thus maintaining it in position.

Ø metric:  
6 to 12 mm

## Technical Characteristics

- **Compatible Fluids:** compressed air
- **Working Pressure:** 1 to 10 bar
- **Working Temperature:** -5°C to +60°C
- **Cracking Pressure:** 0.3 bar

## Advantages

- Mounted in pairs on a cylinder
- 3 functions in 1 compact product:
  - piloted non-return valve
  - flow control regulator
  - manual exhaust
- Vent saves time on restart after maintenance operations

## Component Materials

### Silicone-free

Venting button: nickel-plated brass

Body:  
nickel-plated brass

Piston:  
nickel-plated brass

Valve poppet:  
nickel-plated brass,  
technical polymer

Gripping ring: stainless steel

Seals: NBR

Locking nut:  
nickel-plated brass

Flow control regulator body:  
technical polymer

Adjustment screw:  
nickel-plated brass

## Regulations

• RoHS

• REACH

• PED

## Operation

### Normal Operation

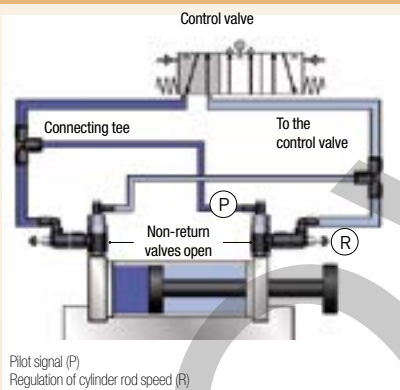

### Emergency Stop or Pressure Drop

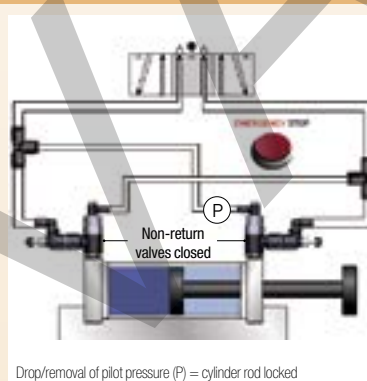

### Venting Operation

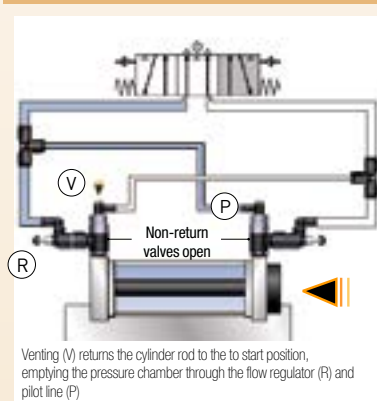

Model		Pilot and depilot threshold				
		2 bar	4 bar	6 bar	8 bar	10 bar
G1/8	Pilot Pressure	1.2	1.72	2.44	2.96	3.56
	Depilot Pressure	0.56	0.96	1.12	1.76	2.12
G1/4	Pilot Pressure	0.92	1.52	2.12	2.68	3.28
	Depilot Pressure	0.64	1.16	1.68	2.16	2.64
G3/8	Pilot Pressure	1.12	1.84	2.56	3.32	4.08
	Depilot Pressure	0.64	1.04	1.44	1.84	2.36
G1/2	Pilot Pressure	1.04	1.60	2.12	2.76	3.88
	Depilot Pressure	0.76	1.28	1.76	2.20	2.72

Maximum Flow at 6 bar (NI/min)	7894 06 10	7894 06 13	7894 08 10	7894 08 13	7894 08 17	7894 10 17	7894 10 21	7894 12 21
Direction of Adjustment	250	475	240	585	875	940	1535	1560
Return	365	620	355	815	1085	1205	1860	1940

# Piloted Non-Return Valves

## 7892 Piloted Non-Return Valve, Male BSPP Thread

Technical polymer, Nickel-plated brass, NBR

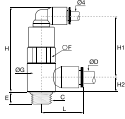

ØD	C		E	F	G	H	H1	H2	L	Kg
6	G1/8	<b>7892 06 10</b>	6	13	14	42	30	7	21	0.020
	G1/4	<b>7892 06 13</b>	9	17	18.5	45	32	9	23	0.042
8	G1/8	<b>7892 08 10</b>	6	13	14	42	29	9	25	0.020
	G1/4	<b>7892 08 13</b>	9	17	18.5	45	32	9	27	0.042
10	G3/8	<b>7892 08 17</b>	6	20	22.5	57	41	11	28	0.093
	G3/8	<b>7892 10 17</b>	6	20	22.5	57	41	11	31	0.144
12	G1/2	<b>7892 10 21</b>	10	24	28	63	47	16	36	0.109
	G1/2	<b>7892 12 21</b>	10	24	28	63	47	16	36	0.150

## 7894 Piloted Non-Return Valve with Flow Regulator Exhaust, Male BSPP Thread

Technical polymer, Nickel-plated brass

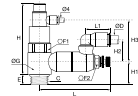

ØD	C		E	F1	F2	G	H	H1	H2	H3	L	L max	L1	Kg
6	G1/8	<b>7894 06 10</b>	6	13	8	14	46	7	24	31	48.5	51	16	0.041
	G1/4	<b>7894 06 13</b>	9	17	10	18.5	49	11	18	31	59.5	65	17	0.067
8	G1/8	<b>7894 08 10</b>	6	13	8	14	46	7	27	31	48.5	51	22	0.051
	G1/4	<b>7894 08 13</b>	9	17	10	18.5	49	11	23	31	59.5	65	23	0.068
10	G3/8	<b>7894 08 17</b>	7	20	14	22.5	69	13	21	40	67.5	73	23	0.060
	G3/8	<b>7894 10 17</b>	7	20	14	22.5	69	13	29	40	67.5	73	26	0.061
12	G1/2	<b>7894 10 21</b>	9	24	17	28	76	12.5	26	47	74	81	26	0.234
	G1/2	<b>7894 12 21</b>	9	24	17	28	76	12.5	27	47	74	81	30	0.237

# Non-Return Valves



Non-return valves allow compressed air to flow in one direction and prevent it from flowing in the other. Protect the circuit upstream.

Ø metric:  
4 to 12 mm

## Technical Characteristics

Compatible Fluids	Compressed air	
Working Pressure	1 to 10 bar	
Working Temperature	0°C to +70°C	
Cracking Pressure	0.3 bar	
Flow Characteristics (NI/min)	<b>Model</b>	<b>Flow at 6 bar</b>
	4 mm	350
	6 mm	670
	8 mm	1080
	10 mm	2230
12 mm	2300	

## Component Materials

Silicone-free

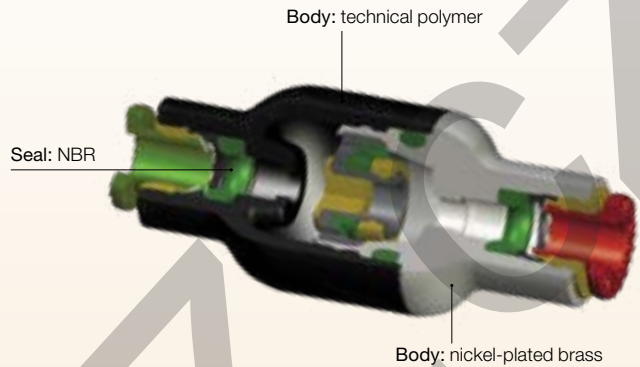

## Advantages

- Available in threaded or push-in version
  - Proven endurance according to the requirements of the DI 2006/42/CE
- Safe installation:**
- Symbol showing the operating direction of flow
  - Colour code: green for supply version, red for exhaust version

## Regulations

- RoHS
- REACH
- PED
- B10d: > 40 millions of cycles

## Operation

### In-Line Version

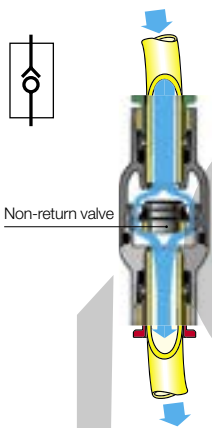

### Supply Version

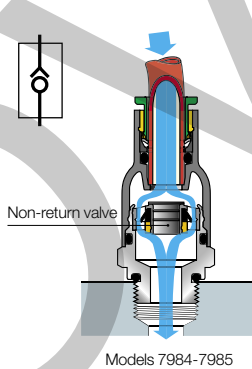

### Exhaust Version

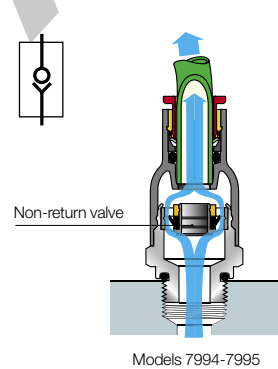

### Installation Diagram

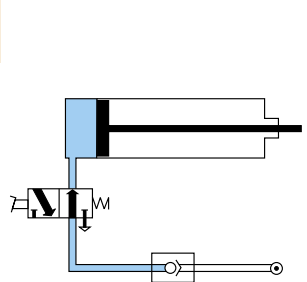

# Non-Return Valves

## 7996 In-Line Equal Non-Return Valve

Technical polymer, Nickel-plated brass, NBR

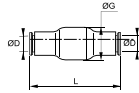

ØD		G	L	Kg
4	<b>7996 04 00</b>	16	38.5	0.008
6	<b>7996 06 00</b>	16	41	0.013
8	<b>7996 08 00</b>	19	51.5	0.017
10	<b>7996 10 00</b>	23	63.5	0.070
12	<b>7996 12 00</b>	23	66.5	0.050

## 7984 In-Line Non-Return Valve, Supply, Male BSP and Metric Thread

Technical polymer, Nickel-plated brass, NBR

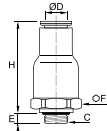

ØD	C	E	F	H	Kg
4	M5x0.8 <b>7984 04 19</b>	3	9	32	0.008
	G1/8 <b>7984 04 10</b>	5	16	28.5	0.015
6	G1/8 <b>7984 06 10</b>	5	16	30.5	0.015
	G1/4 <b>7984 06 13</b>	5.5	16	30.5	0.015
8	G1/8 <b>7984 08 10</b>	5	19	36	0.021
	G1/4 <b>7984 08 13</b>	5.5	19	36	0.023

## 7994 In-Line Non-Return Valve, Exhaust, Male BSP and Metric Thread

Technical polymer, Nickel-plated brass, NBR

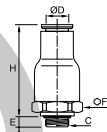

ØD	C	E	F	H	Kg
4	M5x0.8 <b>7994 04 19</b>	3	9	32	0.790
	G1/8 <b>7994 04 10</b>	5	16	28.5	0.018
6	G1/8 <b>7994 06 10</b>	5	16	30.5	0.015
	G1/4 <b>7994 06 13</b>	5.5	16	30.5	0.015
8	G1/8 <b>7994 08 10</b>	5	19	36	0.023
	G1/4 <b>7994 08 13</b>	5.5	19	36	0.023
12	G1/2 <b>7994 12 21</b>	7.5	23	44	0.045

## 7985 In-Line Non-Return Valve, Supply, Male BSPT Thread

Technical polymer, Nickel-plated brass, NBR

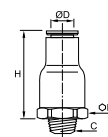

ØD	C	F	H	Kg
4	R1/8 <b>7985 04 10</b>	16	28.5	0.016
6	R1/8 <b>7985 06 10</b>	16	30.5	0.016
	R1/4 <b>7985 06 13</b>	16	30.5	0.021
8	R1/8 <b>7985 08 10</b>	19	36	0.022
	R1/4 <b>7985 08 13</b>	19	36	0.020
12	R1/2 <b>7985 12 21</b>	23	44	0.048

Pre-coated thread

## 7995 In-Line Non-Return Valve, Exhaust, Male BSPT Thread

Technical polymer, Nickel-plated brass, NBR

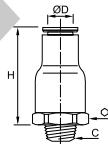

ØD	C	F	H	Kg
4	R1/8 <b>7995 04 10</b>	16	28.5	0.015
6	R1/8 <b>7995 06 10</b>	16	30.5	0.016
	R1/4 <b>7995 06 13</b>	16	30.5	0.022
8	R1/8 <b>7995 08 10</b>	19	36	0.022
	R1/4 <b>7995 08 13</b>	19	36	0.026
12	R3/8 <b>7995 12 17</b>	23	42	0.042

Pre-coated thread

# Adjustable Non-Return Valves

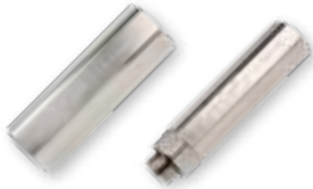

These nickel-plated brass adjustable non-return valves allow compressed air to flow in one direction and prevent flow in the other. They incorporate precise adjustment of opening pressure in the return direction.

## Technical Characteristics

- **Compatible Fluids:** compressed air
- **Working Pressure:** 0 to 12 bar
- **Working Temperature:** -20°C to +80°C

Cracking Pressure	Threads		0 to 4 turns (values given as an example only)	
	M5x0.8 - G1/8 - G1/4		1 to 0.10 bar	
	G3/8		1 to 0.15 bar	
	G1/2		1 to 0.20 bar	

Max. Tightening Torques	Threads	M5 x0.8	G1/8	G1/4	G3/8	G1/2
	daN.m	0.16	0.8	1.2	3	3.5

## Advantages

- Adjustment and locking of the non-return valve cracking pressure with two 2 Allen keys prevents the settings from being accidentally changed
- Designed with locking nut to protect initial setting in the event of vibration or accidental handling
- Developed for the food process industry (FDA compliance) and smooth external profile to facilitate cleaning in situ

## Operation

### Step 1

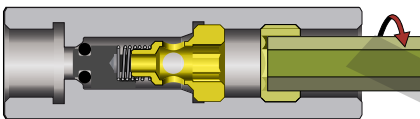

Unscrew the locking nut with an Allen key.

### Step 2

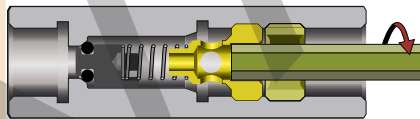

Unscrew the adjustment nut with a smaller Allen key to adjust the cracking pressure. The number of turns adjusts the cracking pressure from 1 bar to 0.10 bar.

### Step 3

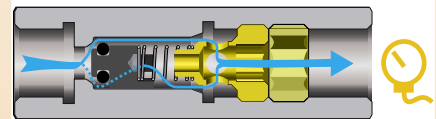

Tighten the locking nut with the Allen key to lock the cracking pressure setting. Then, control the pressure with a pressure gauge downstream.

## Component Materials

### External Components

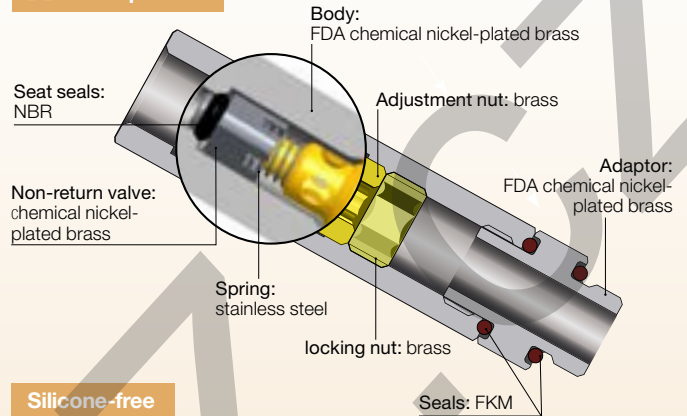

### Silicone-free

## Regulations

- RoHS
- FDA : 21CFR
- REACH

## 7930 Adjustable Check Valve, Double Female BSPP and Metric Thread

FDA chemical Nickel-plated brass, FKM

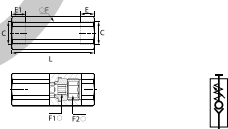

C	E	E1	F	F1	F2	L	Kg
M5x0.8 <b>7930 19 19</b>	8	4	13	4	6	49	0.055
G1/8 <b>7930 10 10</b>	8	6	13	4	6	45	0.033
G1/4 <b>7930 13 13</b>	10	7.5	16	6	8	54	0.073
G3/8 <b>7930 17 17</b>	11	8.5	20	8	10	61.5	0.163
G1/2 <b>7930 21 21</b>	13	10	24	10	12	73	0.171

## 7931 Adjustable Check Valve Supply, Male/Female BSPP Thread

FDA chemical Nickel-plated brass, FKM

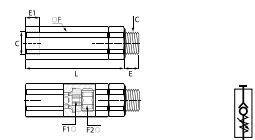

C	E	E1	F	F1	F2	L	Kg
G1/8 <b>7931 10 10</b>	5.5	6	13	4	6	51.5	0.043
G1/4 <b>7931 13 13</b>	6.5	7.5	16	6	8	61.5	0.208
G3/8 <b>7931 17 17</b>	7.5	8.5	20	8	10	70	0.125
G1/2 <b>7931 21 21</b>	9	10	24	10	12	82.5	0.212

# Adjustable Non-Return Valves

## 7932 Adjustable Check Valve Exhaust, Male/ Female BSPP Thread

FDA chemical Nickel-plated brass, FKM

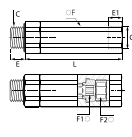

C		E	E1	F	F1	F2	L	Kg
G1/8	<b>7932 10 10</b>	5.5	8	13	4	6	51.5	0.009
G1/4	<b>7932 13 13</b>	6.5	10	16	6	8	61.5	0.058
G3/8	<b>7932 17 17</b>	7.5	11	20	8	10	70	0.123
G1/2	<b>7932 21 21</b>	9	13	24	10	12	82.5	0.212

### Complementary Products for Adjustable Non-Return Valves

#### Fittings

LF 3000



LF 3600



Nickel-Plated Accessories



# LIQUIfit® Non-Return Valves



LIQUIfit® non-return valves allow flow in one direction and prevent any return flow. Fitted in the circuit, they provide total protection.

Ø metric: 6 to 12 mm  
Ø inch: 1/4" to 1/2"

## Technical Characteristics

- **Compatible Fluids:** water, beverages, liquid foodstuffs
- **Working Pressure:** 1 to 10 bar
- **Working Temperature:** 1°C to +65°C
- **Cracking Pressure:** 0.02 bar up to O.D. 3/8"  
0.03 bar for O.D. 1/2"

## Advantages

- Fully compatible for use with water, beverages, liquid foodstuffs and gas
- Excellent chemical compatibility
- Hygienic design with smooth surfaces

## Component Materials

Silicone-free



## Regulations

- RoHS
- FDA: 21 CFR
- NSF 51
- REACH

## 7992 Single Non-Return Valve

POM, EPDM

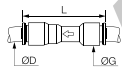

ØD		G	L	Kg
6	<b>7992 06 00WP2</b>	15.5	45.5	0.007
8	<b>7992 08 00WP2</b>	17.5	48.5	0.010
10	<b>7992 10 00WP2</b>	20	57.5	0.014
12	<b>7992 12 00WP2</b>	23.5	67.5	0.022

## 7992 Single Non-Return Valve

Inch

POM, EPDM



ØD		G	L	Kg
1/4	<b>7992 56 00WP2</b>	17	51	0.008
3/8	<b>7992 60 00WP2</b>	20	55	0.011
1/2	<b>7992 62 00WP2</b>	23	68	0.021

5/16" also available = 7992 08 00WP2

## Associated Products

The full range of LIQUIfit® products can be found in this catalogue:

- Push-in fittings for metric and inch tubing (Chapter 1)
- Valves (Chapter 4)

To complement the LIQUIfit® range, Parker Legris Advanced PE tubing (Chapter 3) is suited to the most demanding environments, approved for permanent contact with beverage and food products, as well as for water treatment.

# Stainless Steel Non-Return Valves



In harsh environments or for corrosive industrial fluids, stainless steel non-return valves allow fluids to flow in one direction and prevent them from flowing in the other.

## Technical Characteristics

- **Compatible Fluids:** Many fluids
- **Working Pressure:** 0.5 to 40 bar
- **Working Temperature:** -20°C to +180°C

	Threads	NI/min	Kv
<b>Flow Characteristics</b>	G1/8	18.88	1.60
	G1/4	19.91	1.69
	G3/8	35.54	3.01
	G1/2	36.50	3.10
	G3/4	65.86	5.59
	G1	92.60	7.86
<b>Cracking Pressure</b>	0.25 bar		

## Advantages

- Mechanical robustness and reduced dimensions
- Suitable for use with many chemicals or in corrosive environments
- Flow direction symbol protects against incorrect installation
- Smooth external surfaces contribute to equipment cleanliness

## Component Materials

Silicone-free

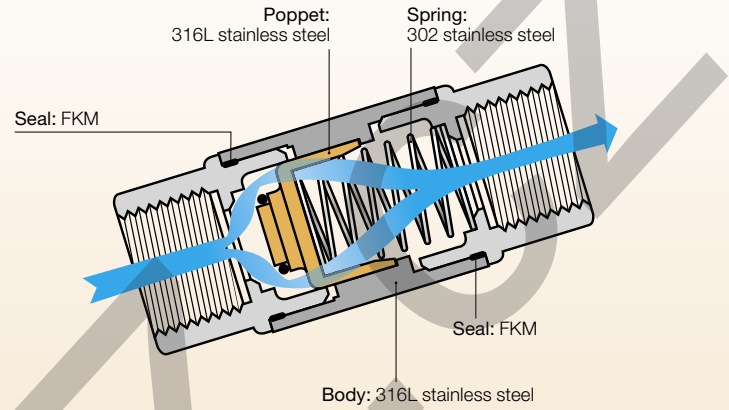

## Regulations

- RoHS
- REACH
- PED

## 4890 Non-Return Valve, Female BSPP Thread

Stainless steel 316L, FKM

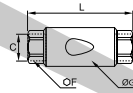

DN	C		F	G	L	Kg
10	G1/8	<b>4890 10 10</b>	17	22	50	0.082
	G1/4	<b>4890 13 13</b>	17	22	50	0.073
15	G3/8	<b>4890 17 17</b>	22	30	67	0.183
	G1/2	<b>4890 21 21</b>	24	30	71	0.182
20	G3/4	<b>4890 27 27</b>	32	42	84	0.288
25	G1	<b>4890 34 34</b>	38	42	90	0.418

## 4892 Non-Return Valve, Supply, Female BSPP Thread/Exhaust, Male BSPP Thread

Stainless steel 316L, FKM

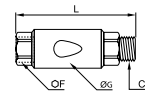

DN	C		F	G	L	Kg
10	G1/8	<b>4892 10 10</b>	17	22	56	0.090
	G1/4	<b>4892 13 13</b>	17	22	58	0.082
15	G3/8	<b>4892 17 17</b>	22	30	75	0.191
	G1/2	<b>4892 21 21</b>	24	30	79	0.210
20	G3/4	<b>4892 27 27</b>	32	42	84	0.313
25	G1	<b>4892 34 34</b>	38	42	102	0.514

## 4891 Non-Return Valve, Supply, Male BSPP Thread/Exhaust, Female BSPP Thread

Stainless steel 316L, FKM

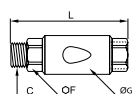

DN	C		F	G	L	Kg
10	G1/8	<b>4891 10 10</b>	17	22	56	0.084
	G1/4	<b>4891 13 13</b>	17	22	58	0.082
15	G3/8	<b>4891 17 17</b>	22	30	75	0.191
	G1/2	<b>4891 21 21</b>	24	30	79	0.210
20	G3/4	<b>4891 27 27</b>	32	42	84	0.300
25	G1	<b>4891 34 34</b>	38	42	102	0.519

## 4895 Non-Return Valve, Female NPT Thread

Stainless steel 316L, FKM

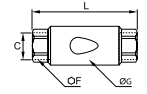

DN	C		F	G	L	Kg
10	NPT1/8	<b>4895 11 11</b>	17	22	50	0.082
	NPT1/4	<b>4895 14 14</b>	17	22	54	0.079
15	NPT3/8	<b>4895 18 18</b>	22	30	67	0.194
	NPT1/2	<b>4895 22 22</b>	24	30	77	0.195