

KOVANZ.CZ

Das SERTO-System

Le Système SERTO

The SERTO System



				Kapitel		Chapitre		Chapter	
Verschraubungen		Raccords	Unions	2	3	4	5	6	8
	Gerade Verschraubung	Union double	Straight union	■	■	■	■	■	■
	mit Einschraubnippel	Union simple mâle	Male adaptor union	■	■	■	■	■	■
	Schottverschraubung	Pour passage de cloison	Panel mount union	■	■	■	■	■	■
	mit Anschlussmuffe	Union simple femelle	Female adaptor union	■	■	■	■	■	■
	Reduktion	Réduction	Reduction	■	■	■	■	■	■
	Anschlussnippel	Ecrou de raccord. mâle	Nipple connection			■			
	Mit Einlöt-/Anschweissnippel	Avec embout à braser/à souder	Solder/weld-on union			■	■	■	
	Verbindungsnippel	Pièce folle	Tube stub	■		■	■		■
	Einstellbarer Anschluss	Union orientable	Adjustable male adaptor	■		■	■	■	■
Winkelverschraubungen		Coudes	Elbow unions	2	3	4	5	6	8
	Winkelverschraubung	Coude	Elbow union	■	■	■	■	■	■
	Verschraubung mit Aussengewinde	Coude mâle	Male adaptor elbow union	■	■	■	■	■	■
	Verschraubung mit Einstellzapfen	Coude orientable	Adjustable elbow union	■	■	■	■		■
	Winkelschottverschraubung	Coude pour passage de cloison	Panel mount elbow			■	■	■	■
	Winkelverschraubung mit Übergangsnippel	Coude avec adaptateur mâle	Elbow with male adaptor	■		■	■		
	Winkelverschraubung mit Übergangsmuffe	Coude avec adaptateur femelle	Elbow with female adaptor	■		■	■		
	Anschlusswinkel	Coude femelle	Female adaptor elbow union			■			
	Schwenkverschraubung	Coude banjo	Single banjo		■	■	■	■	
	Mehrfachverteiler	Coude banjo multiple	Double banjo		■	■			
	Schwenkverschraubung mit Drossel-Ventil	Coude banjo à passage réglable	Banjo with throttle valve			■			
	Schwenkverschraubung mit Drossel-Rückschlagventil	Coude banjo à passage réglable et soupape de retenue	Single banjo with non-return throttle valve			■			
Winkelverteiler		Distributeurs	V-distributor unions	2	3	4	5	6	8
	Winkelverteiler	Distributeur	V-distributor union			■			
	mit Nippel	avec pièce intermédiaire mâle	with male adaptor			■			
	mit Muffe	avec pièce intermédiaire femelle	with female adaptor			■			

				Kapitel		Chapitre		Chapter	
				2	3	4	5	6	8
T-Verschraubungen				Tés		Tee unions			
	T-Verschraubung	Té	Tee	■	■	■	■	■	■
	T-Verschraubung mit Aussengewinde	Té mâle	Male adaptor tee union	■	■	■	■		■
	T-Verschraubung mit Übergangsnippel	Té avec adaptateur mâle	Tee with male adaptor			■	■		
	T-Verschraubung mit Übergangsmuffe	Té avec adaptateur femelle	Tee with female adaptor	■		■	■		
	T-Verschraubung mit Einstellzapfen	Té orientable	Adjustable Tee		■	■	■		■
	L-Verschraubung mit Aussengewinde	Té mâle L	Male tee L		■	■	■		■
	T-Schwenkverschraubung	Té banjo	Tee banjo union		■	■			
	T-Mehrfachverteiler	Té banjo multiple	Tee double banjo		■	■			
Y-Verbindung				Y-égale		Y-connector			
	Y-Verbindung	Y-égale	Y-connector		■				
	Y-Einschraubverbindung	Union mâle-Y	Y-male connector		■				
Kreuzstück				Croix		Cross union			
	Verschraubung	Croix	Cross			■	■		
	mit Übergangsnippel	avec adaptateur mâle	with male adaptor			■	■		
	mit Übergangsmuffe	avec adaptateur femelle	with female adaptor			■	■		
Ergänzungsteile				Pièces complémentaires		Additional parts			
	Abschlusszapfen	Bouchon d'arrêt	Plug	■	■	■	■	■	■
	Klemmring	Bague de serrage	Compression ferrule	■	■	■	■	■	■
	Armaturenanschluss	Ecrou de raccordement	Nut connector	■	■	■	■		■
	Stützhülse	Douille d'appui	Stiffener sleeve	■		■	■	■	■
	Sechskantmutter	Ecrou à six pans	Hexagon nut	■		■	■	■	■
	Übergangsmuffe	Adaptateur femelle	Female adaptor	■	■	■	■		■
	Übergangsnippel	Adaptateur mâle	Male adaptor	■	■	■	■		■
	Dichtung	Joint	Washer			■			
	Verschlusschraube	Bouchon d'obturation	Screw plug			■			
	Schlauchtülle	Douille cannelée	Hose nozzle	■		■	■		■

			Kapitel		Chapitre		Chapter	
Ventile	Robinets	Valves	PVDF	PA	Ms	SS	Ms-CV	7
Regulierventile	Robinets de réglage	Regulating valves	✓	✓	✓	✓		■
Feinregulierventile	Robinets de réglage de précision	Fine regulating valves			✓	✓		■
Kugelhahn	Robinet à bille	Ball valve	✓		✓	✓		■
Absperrhahn	Vanne à boisseau ¼ de tour	Stop cock	✓		✓	✓		■
Durchgangshahn	Robinet simple à passage direct	Total flow cock			✓			■
Schwenkdrossel Ventil	Coude banjo à passage réglable	Banjo with throttle valve		✓	✓			■
Drossel-Rückschlagventil	Coude banjo à passage réglable et soupape de retenue	Single banjo with non-return throttle valve		✓	✓			■
Rückschlagventile	Soupapes de retenue	Non-return valves	✓		✓	✓		■
Adapter	Adaptateur	Adaptor	PVDF	PA	Ms	SS	Ms-CV	9
			✓	✓	✓	✓	✓	■
			✓	✓	✓	✓	✓	■
Verteilerleisten	Distributeur	Manifold	PVDF	PA	Ms	SS	Ms-CV	9
Verteilerleisten	Distributeur	Manifold	✓					■
Stecktüllen	Douilles cannelées	Hose nipples	PVDF	PA	Ms	SS	Ms-CV	9
Stecktüllen	Douilles cannelées	Hose nozzles	✓				✓	■
Rohre, Schläuche	Tubes, tuyaux	Tubes, hoses						10
Präzisionsrohre aus Edelstahl	Tubes de précision en acier inoxydable	Stainless steel tubes						■
Rohre aus PTFE	Tubes en PTFE	PTFE tubes						■
Rohre aus PVDF	Tubes en PVDF	PVDF tubes						■
Rohre aus FEP	Tubes en FEP	FEP tubes						■
Rohre aus PA	Tubes en PA	PA tubes						■
Rohre aus LD-PE	Tubes en LD-PE	LD-PE tubes						■
Schläuche aus PU	Tuyaux en PU	PU hoses						■
«jacoflon» Schläuche	Tuyaux «jacoflon»	«jacoflon» hoses						■
«SERTOflex» Rohre	Tubes «SERTOflex»	«SERTOflex» tubes						■
Schläuche PFA	Tuyaux en PFA	PFA hoses						■

	Zubehör und Werkzeug	Accessoires et outillage	Accessories and tooling	Kapitel		Chapitre		Chapter	
				PVDF	PA	Ms	SS	Ms-CV	11
	Montagestutzen	Pièce de montage	Pre-assembly stud	✓	✓	✓	✓		■
	T-Clip	T-Clip	T-Clip			✓	✓		■
	Distanzhalter	Cale d'épaisseur	Spacer	✓		✓	✓		■
	Fixbandrohrschele	Collier de fixation	Strap pipe clip	✓		✓	✓		■
	Winkelspange	Pince d'angle	Bend clip			✓			■
	Plasto-Joint	Plasto-Joint	Plasto-Joint		✓	✓			■
	Gewindedichtungsband aus PTFE	Ruban en PTFE	Thread seal tape from PTFE		✓	✓			■
	Schlauch-Cutty	Tube-cutty	Hose-cutty	✓		✓	✓		■
	Entgratungswerkzeug	Outil d'ébarbage	Deburring tool						■
	SERTOtool, pneumatisches Vormontagegerät für Rohrdurchmesser 4 - 10 mm	SERTOtool, appareil pneumatique pour le pré-montage des diamètres 4 - 10 mm	SERTOtool, pneumatic apparatus for the pre-assembly of diameters 4 - 10 mm						■
	SERTOmatic, hydraulisches Vormontagegerät für Rohrdurchmesser 10 - 35 mm	SERTOmatic, appareil hydraulique pour le pré-montage des diamètres 10 - 35 mm	SERTOmatic, hydraulic apparatus for the pre-assembly of diameters 10 - 35 mm						■
Kupplungen				Coupleurs		Couplings		12	
	Schnellkupplungen Serie 20, 21, 22	Coupleur rapide Série 20, 21, 22	Quick couplings Serie 20, 21, 22						■
	SERTOchem DN 10	SERTOchem DN 10	SERTOchem DN 10						■
	SERTOchem DN 5	SERTOchem DN 5	SERTOchem DN 5						■
	Schnellkupplungen POM	Coupleur rapide POM	Quick couplings POM						■
	Schnellkupplungen Serie EA, E, H, T (Messing)	Coupleur rapide Serie EA, E, H, T (Laiton)	Quick couplings Serie EA, E, H, T (Brass)						■
	Schnellkupplungen Serie JA, EA, E, H, T, V25, P25 (Inox)	Coupleur rapide Serie EA, E, H, T, V25, P25 (Inox)	Quick couplings Serie EA, E, H, T, V25, P25 (Inox)						■
	Schnellkupplungen Serie H, T (Stahl)	Coupleur rapide Serie H, T (Acier)	Quick couplings Serie H, T (Steel)						■

Wie finde ich die richtige Systemgruppe?
Comment puis-je trouver le groupe de système adéquat?
How do I find the right system group?

Das SERTO System wurde nach Materialart gegliedert. Welches Lieferprogramm gewählt wird, richtet sich in erster Linie nach dem zu transportierenden Medium, dem Betriebsdruck und der Temperatur.

Le système SERTO a été structuré en fonction du type de matériel. Le programme de livraison qui est sélectionné dépend avant tout du fluide à acheminer, de la pression de service et de la température.

The SERTO system has been structured according to material type. The product range selected is governed principally by the medium to be conveyed, by the operating pressure and by the temperature.

Für eine detaillierte Beratung wenden Sie sich bitte an Ihre SERTO-Vertretung.

Si vous avez besoin de conseils précis, veuillez vous adresser à votre représentant SERTO.

For detailed information please consult your SERTO agent.

Medien, Rohrmaterial und Umgebung
Fluides, matériaux de tubes et environnement
Medium, tube material and environment

Programm Programme Product range	Geeignete Medien Fluides appropriés Appropriate media			Aggressivität Agressivité Aggressiveness			Umgebung Environnement Environment			Anzuschliessende Rohre Tubes à raccorder Tubes to be connected				
	Luft air air	Gas Gaz Gases	Flüssig Fluides Liquid	Oele Huile Oil	aggressiv agressif aggressive	leicht aggressiv peu agressif slightly	nicht aggressiv pas agressif non-aggressive	korrosiv corrosif corrosive	nicht korrosiv non corrosif non-corrosive	Buntmetall Métaux lourds non ferreux Non-ferrous heavy metals	Stahl Acier Steel	Nichrostender Stahl Acier inoxydable Stainless steel	Leichtmetall Métaux légers Light metals	Kunststoff Matières plastiques Plastics
PVDF PVDF PVDF	•	•	•	•	•	•	•	•	•					•
PA PA PA	•	•					•		•					•
Flip Flip Flip	•						•		•					•
Messing M/G Laiton M/G Brass M/G	•	•	•	•			•		•	•				•
Messing chem.-vernickelt Laiton nicklé chimique Brass chem. nickel-plated	•	•	•	•		•	•		•	•				•
Edelstahl Acier inoxydable Stainless steel	•	•	•	•	•	•	•	•	•		•			•
Stahl Acier Steel	•	•	•	•	•	•	•	•	•	•				

Rohrdurchmesser und max. Betriebsdruck

Diamètre du tube et pression maximale de service

Tube diameter and maximum operating pressure



Die Zahlen in den Balken zeigen den maximal zulässigen Betriebsdruck des jeweiligen Durchmesserbereichs.

Les valeurs indiquées ci-après indiquent la pression de service maximale admissible en fonction du diamètre du tube.

The values indicated in the bars indicate the maximum admissible operating pressure of the respective pressure range.

SERTO Verschraubungen eignen sich für den Vakuumbereich bis 10⁻⁴ mbar.

Les raccords SERTO conviennent pour une plage de vide qui ne dépasse pas 10⁻⁴ mbar.

SERTO unions are suitable for vacuum ranging up to 10⁻⁴ mbar.

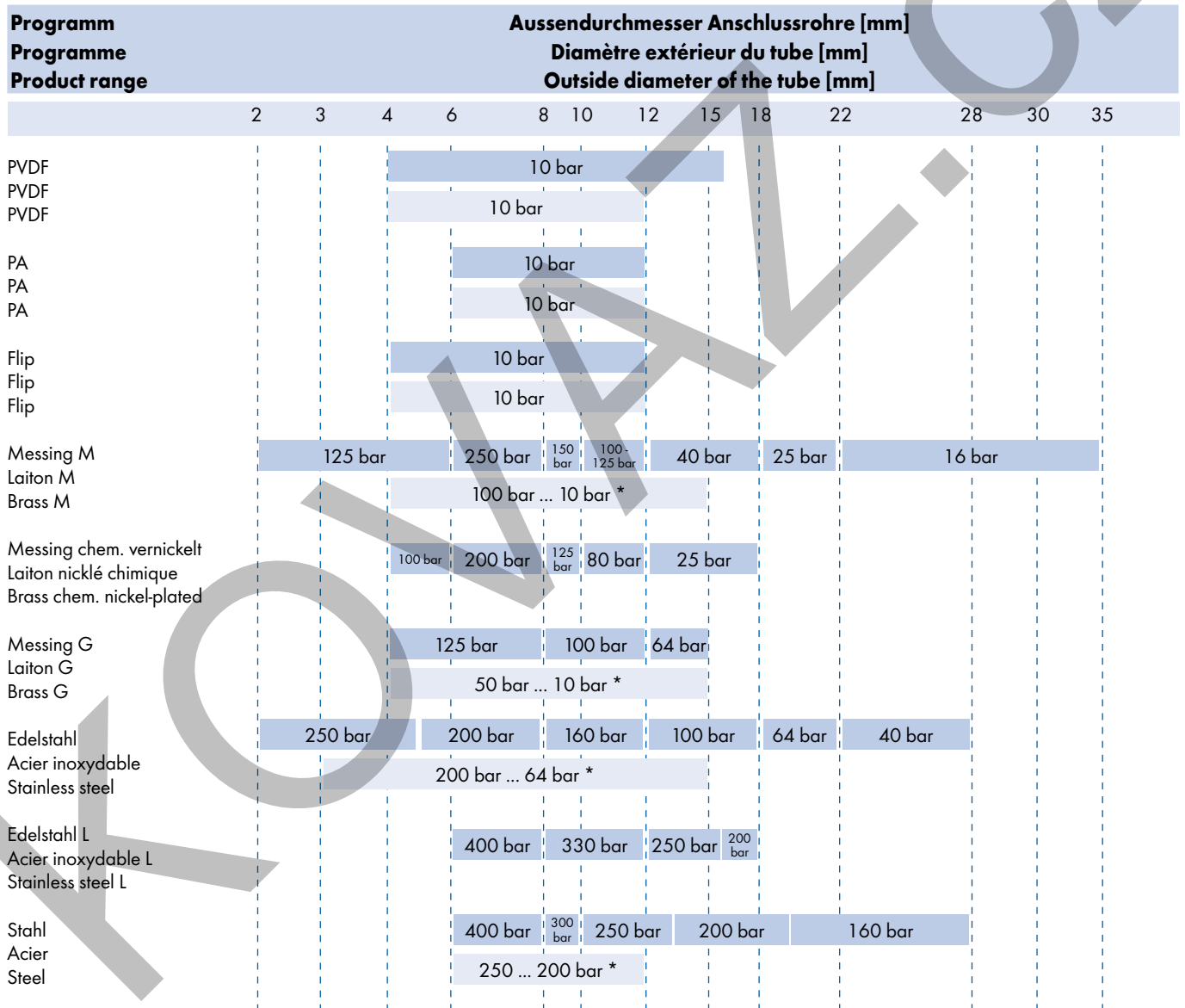

* effektive Werte siehe indiv. Typentabelle

* valeurs effectives voir tableau du produit ind.

* effective values see ind. table of product

Verschraubungen Ventile

Raccords Robinets

Tube unions Valves

Temperaturen und Druckauswertungsgrad Températures et degré d'évaluation de la pression Temperatures and pressure coefficient

Die Prozentwerte in den Balken zeigen den Druckauswertungsgrad des Betriebsdruckes in Abhängigkeit der Temperatur.

Les valeurs en pourcentage figurant ci-dessous dans les barres ci-après indiquent le degré d'évaluation de la pression de service en fonction de la température.

The percentage values in the bars indicate the operating pressure coefficient in function of temperature.

Gültig für SERTO Verschraubungen.

Applicable aux raccords SERTO.

Applicable for SERTO unions.

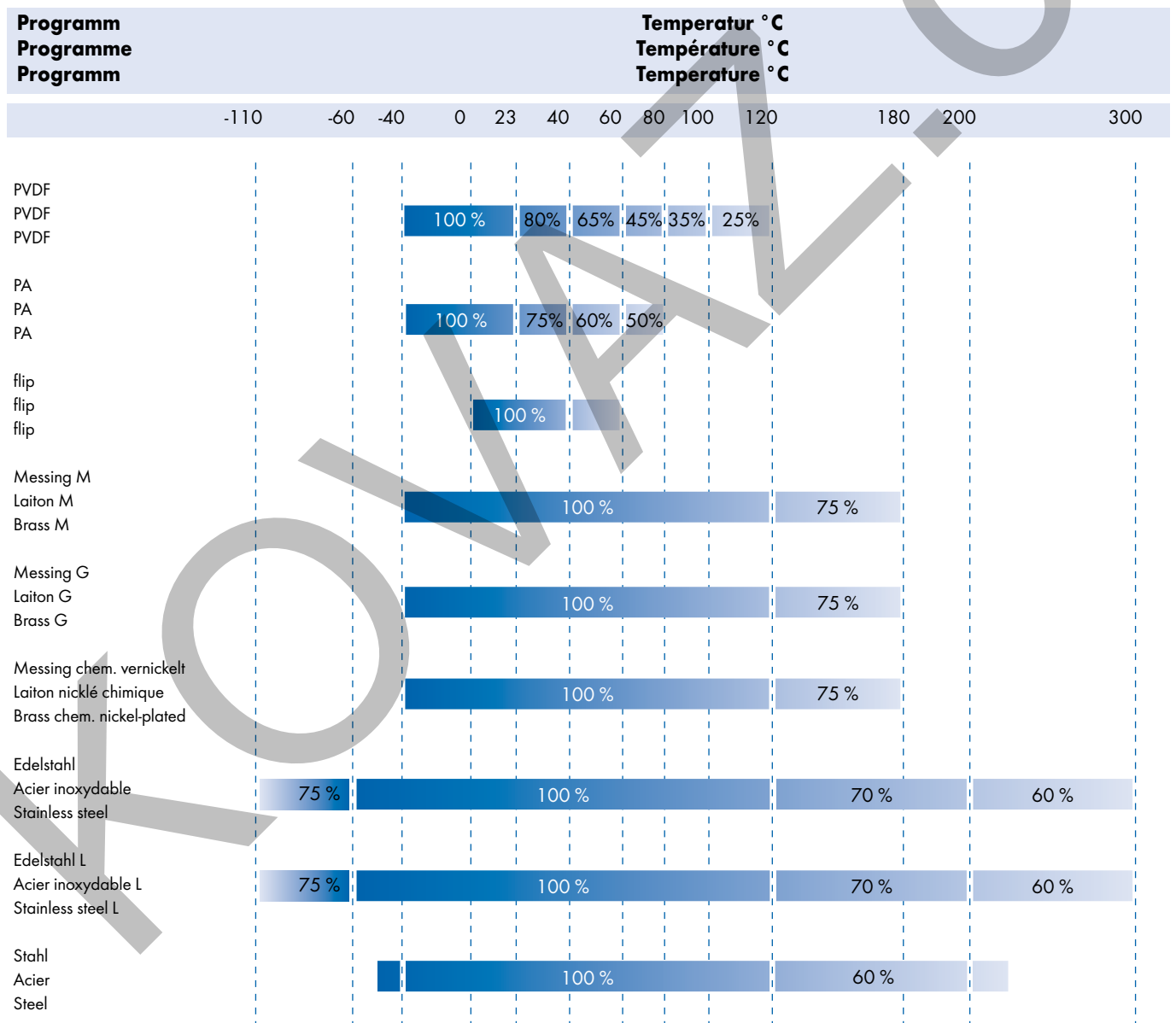

Messing M

Verschraubungen

























Laiton M









Raccords





Brass M

Unions









	Seite/Page/Page		Seite/Page/Page		Seite/Page/Page
Klemmring Bague de serrage Compression ferrule	35-37 	Übergangsnippel Adaptateur femelle - mâle Male adaptor	49-50 	Verschraubung mit Einlötnippel Union avec embout à braser Adaptor union with soldering nipple	69 
	SO 40001		SO 40040		SO 41421
Abschlusszapfen Bouchon d'arrêt Plug	38 	Schlauchtülle Douille cannelée Hose nozzle	51-52 	Gerade Schottverschraubung Union double traversée de cloison Panel mount union	70-73 
	SO 40002		SO 40503		SO 41521
Stützhülse Douille d'appui Stiffener sleeve	39-40 	Anschlussnippel Ecrou de raccordement mâle Nipple connection	53 	Einstellnippel Adaptateur orientable mâle Adjustable male adaptor	74-75 
	SO 40003		SO 41001		SO 41600
Dichtung Joint Washer	41-43 	Gerade Verschraubung Union double Straight union	54-55 	Einstellbare Einschraubverschraubung Union mâle orientable Adjustable male adaptor union	76-77 
	SO 40005		SO 41021		SO 41625
Sechskantmutter METR Ecrou à six pans METR Hexagon nut METR	42 	Gerade Einschraubverschraubung Union mâle Male adaptor union	56-63 	Einstellmuffe Union orientable femelle Adjustable female adaptor	78 
	SO 40006		SO 41121		SO 41704
Anschlussmutter Ecrou Union nut	44 	Gerade Aufschraubverschraubung Union femelle Female adaptor union	64-65 	Einstellbare Aufschraubverschraubung Union femelle orientable Adjustable female adaptor union	79 
	SO 40020		SO 41221		SO 41726
Armaturenanschluss Ecrou et bague de raccordement Nut connection	45-47 	Verbindungsnippel Pièce folle Tube stub	66-67 	Reduktionsverschraubung Union de réduction Reduction union	80-81 
	SO 40021		SO 41300		SO 41821
Übergangsmuffe Adaptateur femelle Female adaptor	48 	Einstellbare Verschraubung Union orientable Adjustable union	68 	Winkelverschraubung Coude Elbow union	82-86 
	SO 40030		SO 41325		SO 42021

	Seite/Page/Page
Anschlusswinkel Coude femelle Female adaptor elbow union	87  SO 42321
Winkel-Einschraubverschraubung Coude mâle Male adaptor elbow union	88-91  SO 42421
Winkel-Aufschraubverschraubung Coude femelle Female adaptor elbow union	92  SO 42521
Einstellbare Winkelverschraubung Coude orientable Adjustable elbow union	93-95  SO 42621
Winkel-Schottverschraubung Coude traversée de cloison Panel mount elbow union	96-97  SO 42721
Schwenkverschraubung Coude banjo Single banjo	98-100  SO 42824
T-Verschraubung Té égal Tee union	101-105  SO 43021
Einstellbare T- und L-Verschraubung Té et L orientable Adjustable tee and L union	106-108  SO 43621

	Seite/Page/Page
T- und L-Einschraubverschraubung Té et L mâle Male adaptor tee and L union	109-110  SO 43721
T-Schwenkverschraubung Té banjo Tee banjo	111-113  SO 43824
Kreuzverschraubung Croix égale Cross union	114  SO 44021
Schwenkverschraubung Coude banjo Single banjo	115-116  SO 47624

Sonderausführungen auf Anfrage
Exécution en option sur demande
Optional services on request

-  Spezialreinigung - entfettet
Traitement spécial - dégraissé
Special treatment - degreased
-  Spezialbehandlung für Einsatz mit Sauerstoff
Traitement spécial pour utilisation sous oxygène
Special treatment for use with oxygen
-  Spezialbehandlung - silikonfrei
Traitement spécial - sans silicone
Special treatment - silicone free
-  Vorbeschichtete Gewinde PTFE-Band umwickelt
Filetages pré enduits avec ruban en PTFE
Pre-coated threads with PTFE-tape
-  Vorbeschichtete Gewinde mit Loctite 5061
Filetages pré enduits avec Loctite 5061
Pre-coated threads with Loctite 5061
-  Chemisch vernickelt
Nickelage chimique
Chemical nickel-plated
-  Messing bleiarml
Laiton à faible teneur en plomb
Low-lead brass

Bestätigungen auf www.serto.com
Confirmations sur www.serto.com
Confirmations on www.serto.com

-  RoHS
-  CE
-  Ex

Messing M

Eigenschaften, Besonderheiten

- einfache, schnelle Montage
- kompakte Baumassee
- grosse Sortimentervielfalt
- sehr viele Kombinationsmöglichkeiten
- zwei Ausführungen:
M = Anschlussmutter metrisch
G = Anschlussmutter Rohrgewinde (Zoll)
(M und G nicht austauschbar)

Funktionsprinzip

Siehe Kapitel i

Werkstoff

Messing CW 617N (CuZn40Pb2), Oberfläche gebeizt.
Chemisch vernickelt siehe Kapitel 2.

Betriebsdruck PN

Siehe Produkttabellen (4-fache Sicherheit)

Temperaturbereich

-196°C bis +180°C

Helium-Leckrate

10⁻⁸ mbar • l/s *

Vakuum

Bis 10⁻⁴ mbar, höhere Werte möglich

Anzuschliessende Rohre

Kunststoffrohre und nahtlose, gezogene Kupferrohre (insbes. EN 12449/1057) mit sauberer, glatter Oberfläche. Toleranz Aussendurchmesser ± 0.1 mm, Rohre Ø < 6 mm Toleranz ± 0.05 mm; Ausnahme: Kunststoffrohre. Siehe auch Kapitel i und Kapitel 19. Weitere Materialien auf Anfrage.

Zulassungen

SVGW, DVGW

Einschraubzapfen, Gewinde

Rohrgewinde (Zoll) und metrisches Feingewinde DIN 3852, kegelig nach Form C, mit Dichtkante nach Form B. NPT-Gewinde nach ANSI B1.20.1.

Zum Abdichten der kegeligen Einschraubgewinde empfehlen wir das PTFE Band AC 840/841 oder Loctite 5061.

Druckauswertungsgrad in % des PN



* bei fachgerechter Montage; siehe Kapitel i:
- Montageanleitung
- Rohempfehlungen

Laiton M

Propriétés, spécificités

- montage facile et rapide
- compactes dimensions
- vaste gamme de produits
- multiples possibilités de combinaisons
- deux exécutions:
M = écrou SERTO avec filetage métrique
G = écrou SERTO avec filetage gaz (BSP)
(M et G ne sont pas interchangeables)

Principe de fonctionnement

Voir chapitre i

Matériau

Laiton CW 617N (CuZn40Pb2), la surface est décapée.
Nickelé chimiquement voir chapitre 2.

Pression de service PN

Voir tableaux des produits (facteur de sécurité 4)

Plage de température admissible

-196°C à +180°C

Débit de fuite avec hélium

10⁻⁸ mbar • l/s *

Vide

Jusqu'à 10⁻⁴ mbar, valeurs plus élevées possible

Tubes à utiliser

Tubes en matière plastique et tous les tubes en cuivre sans soudure (selon EN 12449/1057) avec surface propre et lisse. Tolérance du diamètre extérieur de ± 0.1 mm, tubes Ø < 6 mm tolérance ± 0.05 mm; exception: tubes en plastique. Voir aussi chapitre i et chapitre 19. Autres matériaux sur demande.

Certifications

SSIGE, DVGW

Embouts mâles, filetages

Filetage-gaz (BSP) et filetage métrique à pas fin DIN 3852; conique selon forme C; filetage d'étanchéité selon forme B. Filetage NPT selon ANSI B1.20.1.

Pour assurer l'étanchéité des filetages mâles coniques, nous recommandons le ruban en PTFE AC 840/841 ou Loctite 5061.

Coefficient de pression de service admissible en % de PN

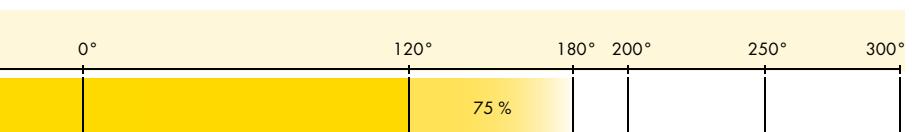

* à la base d'un montage dans les règles de l'art; voir chapitre i:
- Instructions de montage
- Recommandations pour tubes

Brass M

Characteristics, specialities

- easy and fast to install
- compact size
- extensive product range
- many combination possibilities
- two models:
M = connection nut with metric thread
G = connection nut with British Standard Pipe (BSP) thread
(M and G are not interchangeable)

Operating principle

See chapter i

Material

Brass CW 617N (CuZn40Pb2), the surface is pickled.
Chemically nickel plated see chapter 2.

Working pressure PN

See product tables (safety factor 4)

Temperature range

-196°C to +180°C

Leak rate with helium

10⁻⁸ mbar • l/s *

Vacuum

Up to 10⁻⁴ mbar, higher values are possible

Tubes to use

Tubes of plastic and seamless copper tubes (esp. EN 12449/1057) with clean smooth surface. Tolerance of outside diameter ± 0.1 mm, tubes Ø < 6 mm tolerance ± 0.05 mm; exception: plastic tubes. See also chapter i and chapter 19. Further materials on request.

Approvals

SVGW, DVGW

Adaptor stem, male thread

British Standard Pipe (BSP) and metric fine thread DIN 3852; tapered form C; thread with edge seal form B. NPT-thread according to ANSI B1.20.1.

For sealing of the tapered male adaptor thread we recommend the PTFE tape AC 840/841 or Loctite 5061.

Pressure coefficient % of PN

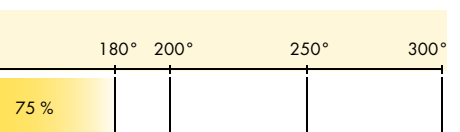

* when professionally assembled; see chapter i:
- Installation instructions
- Recommendations for tubes

Klemmring

Bague de serrage

Compression ferrule

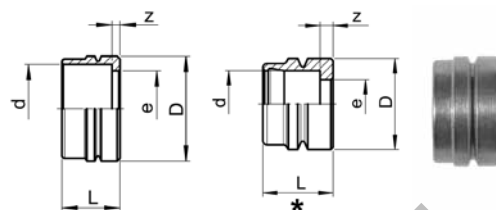

SO 40001

Type-d	Mat.-Nr.	bar	L	D	z	e	kg/100
Für metrische Rohre	Pour tubes métriques		For metric tubes				
SO 40001-2	016.0010.020	125	3.5	5.0	0.6	1.5	0.015
SO 40001-3	016.0010.030	125	4.5	5.0	0.8	2.5	0.030
SO 40001-4	016.0010.040	125	5.0	6.0	1.0	3.4	0.050
SO 40001-5	016.0010.050	125	5.5	6.8	1.0	4.0	0.060
SO 40001-6 *	016.0010.060	250	6.5	8.4	1.2	4.5	0.120
SO 40001-8 *	016.0010.080	150	7.0	10.4	1.2	6.5	0.170
SO 40001-10 *	016.0010.100	125	7.8	12.7	1.2	8.5	0.250
SO 40001-12 *	016.0010.120	100	8.8	14.7	1.2	10.0	0.330
SO 40001-14 *	016.0010.140	40	10.0	17.5	1.4	12.0	0.550
SO 40001-15 *	016.0010.150	40	10.0	18.0	1.4	13.0	0.530
SO 40001-16 *	016.0010.160	40	11.7	21.0	1.4	14.0	0.980
SO 40001-17 *	016.0010.170	40	11.7	21.0	1.4	15.0	0.900
SO 40001-18 *	016.0010.180	40	11.7	22.0	1.4	16.0	0.910
SO 40001-22 *	016.0010.220	25	13.5	26.0	1.4	20.0	1.270
SO 40001-28 *	016.0010.280	16	15.4	32.5	2.0	24.0	2.140
SO 40001-35 *	016.0010.350	16	17.0	39.5	2.0	32.5	3.000
Für Zollrohre	Pour tubes pouces		For inch tubes				
SO 40001-3,2	016.0010.032	125	4.5	5.0	0.8	2.5	0.030
SO 40001-6,35 *	016.0010.063	250	6.5	8.4	1.2	4.5	0.110
SO 40001-7,94 *	016.0010.079	150	7.0	10.4	1.2	6.5	0.170
SO 40001-9,52 *	016.0010.095	125	7.8	12.7	1.2	8.0	0.280
SO 40001-15,88	016.0010.158	40	11.7	21.0	1.4	14.0	0.510
SO 40001-22,22	016.0010.222	25	13.5	26.0	1.4	20.0	1.280

Umrechnung für "d" bei Zollrohren:

3,2 = 1/8
 6,35 = 1/4
 7,94 = 5/16
 9,52 = 3/8
 15,88 = 5/8
 22,22 = 7/8

Conversion de "d" pour tubes en pouces:

3,2 = 1/8
 6,35 = 1/4
 7,94 = 5/16
 9,52 = 3/8
 15,88 = 5/8
 22,22 = 7/8

Conversion for "d" for inch tubes:

3,2 = 1/8
 6,35 = 1/4
 7,94 = 5/16
 9,52 = 3/8
 15,88 = 5/8
 22,22 = 7/8

Klemmring reduziert

Bague de serrage de réduction

Reduction compression ferrule

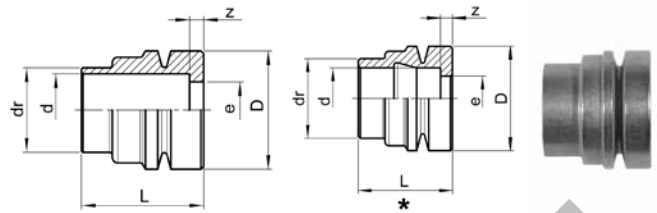

SO 40001 RED

Type-dr-d	Mat.-Nr.	bar	L	D	z	e	kg/100
Für metrische Rohre	Pour tubes métriques		For metric tubes				
SO 40001-5-3	016.0014.060	125	7.5	6.8	0.8	2.5	0.130
SO 40001-6-4	016.0014.110	100	8.5	8.4	1.0	3.4	0.230
SO 40001-6-5	016.0014.117	100	8.7	8.4	1.0	4.0	0.180
SO 40001-8-6 *	016.0014.140	250	9.5	10.5	1.2	4.5	0.330
SO 40001-10-8 *	016.0014.190	150	11.5	12.7	1.2	6.5	0.450
SO 40001-12-10 *	016.0014.240	100	12.5	14.7	1.2	8.5	0.610
SO 40001-14-12	016.0014.340	40	14.0	17.5	1.4	10.0	0.890
SO 40001-15-12	016.0014.420	40	14.0	18.0	1.4	10.0	1.050
SO 40001-15-13	016.0014.430	40	14.0	18.0	1.4	11.0	0.960
SO 40001-17-14	016.0014.530	40	15.7	21.0	1.4	12.0	1.560
SO 40001-18-15	016.0014.610	40	15.7	22.0	1.4	13.0	1.660
SO 40001-18-16	016.0014.620	40	15.7	22.0	1.4	14.0	1.430
SO 40001-22-17	016.0014.750	25	19.0	26.0	1.4	15.0	3.030
SO 40001-22-18	016.0014.755	25	19.0	26.0	1.4	16.0	2.850
SO 40001-22-19	016.0014.760	25	19.0	26.0	1.4	16.0	2.600

Für Zollrohre	Pour tubes pouces		For inch tubes				
SO 40001-4-3,2	016.0014.042	125	7.0	6.0	0.8	2.5	0.090
SO 40001-10-7,94	016.0014.187	150	11.5	12.7	1.2	6.5	0.450
SO 40001-15-12,7 *	016.0014.427	40	15.0	18.0	1.4	11.0	0.990
SO 40001-22-19,05	016.0014.762	25	19.0	26.0	1.4	17.0	2.600

Umrechnung für "d" bei Zollrohren:

3,2 = 1/8
 7,94 = 5/16
 12,7 = 1/2
 19,05 = 3/4

Conversion de "d" pour tubes en pouces:

3,2 = 1/8
 7,94 = 5/16
 12,7 = 1/2
 19,05 = 3/4

Conversion for "d" for inch tubes:

3,2 = 1/8
 7,94 = 5/16
 12,7 = 1/2
 19,05 = 3/4

Anwendungsbeispiele:

Einstufige Reduktionen von Rohranschlüssen sind auf einfachste Art durch Auswechseln der normalen gegen die reduzierten Klemmringe möglich.

Beispiel:

Reduktion eines Rohranschlusses 15 mm auf 12 mm:
 Klemmring SO 40001-15 austauschen gegen SO 40001-15-12 RED. Anschlussmutter SO 40020-15 bleibt.

Exemples d'utilisation:

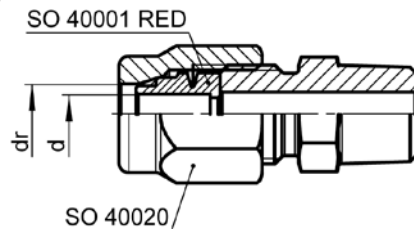

Les réductions à une étape des raccords sont disponibles de manière simple en remplaçant la normale par rapport aux bagues de serrage réduites.

Exemple:

Réduction d'un raccord 15 mm sur 12 mm:
 Bague de serrage SO 40001-15 en échange de SO 40001-15-12 RED. L'écrou SO 40020-15 reste.

Sample combinations:

Single stage reductions for tube connections can be simply achieved by replacing the standard compression ferrule with reduced ones.

Example:

Reduction of a tube connection 15 mm to 12 mm:
 Replace compression ferrule SO 40001-15 with SO 40001-15-12 RED. The union nut SO 40020-15 remains.

Klemmring

für Thermofühler

Bague de serrage

pour sondes

Compression ferrule

for temperature probes

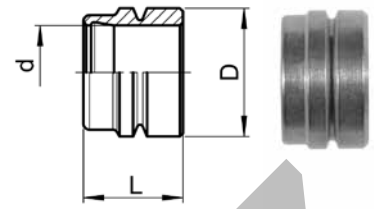

SO 40001 D

Type -d	Mat.-Nr.	bar	L	D	kg/100
SO 40001-3 D	016.0012.030	125	4.5	5.0	0.030
SO 40001-4 D	016.0012.040	125	5.0	6.0	0.050
SO 40001-4-3,2 D	016.0012.042	125	7.0	6.0	0.750
SO 40001-6 D	016.0012.060	100	6.5	8.5	0.110
SO 40001-6-4 D	016.0012.110	100	8.5	8.4	0.210
SO 40001-8 D	016.0012.080	100	7.0	10.5	0.150
SO 40001-8-6 D	016.0012.188	100	9.5	10.5	0.280
SO 40001-10 D	016.0012.100	100	8.0	12.5	0.220
SO 40001-10-8 D	016.0012.190	64	11.5	12.5	0.340

Anwendungsbeispiele:

Exemples d'utilisation:

Sample combinations:

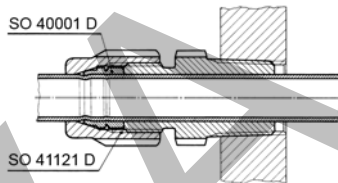

Messleitungen können durch den Klemmring ohne Innenbund durchgesteckt werden. Durchgangsverschraubungen für Messleitungen sind auch erhältlich. Bei Bestellung ist die Typennummer der Standard Verschraubung zusätzlich mit "D" zu ergänzen; z.B. SO 41121-8-1/4 D.

Les lignes de mesure peuvent être insérées à travers la bague de serrage sans collet intérieur. Des raccords pour conduites de mesure sont également disponibles. Lors de la commande, le numéro de type du raccord standard doit être complété avec la lettre "D", par exemple SO 41121-8-1/4 D.

Measuring lines can be pushed through the compression ferrule without collar. Unions for gauge lines are also available. For ordering, the type number of the standard union must be supplemented with "D", e.g. SO 41121-8-1/4 D.

Klemmring

mit integrierter Stützhülse

Bague de serrage

avec douille d'appui intégrée

Compression ferrule

with integrated stiffener sleeve

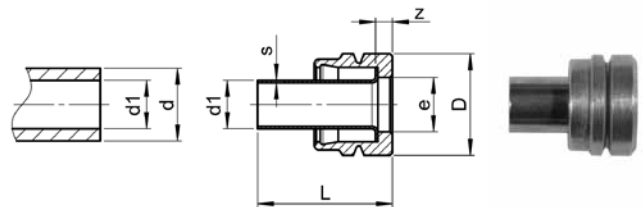

SO 40001 FIX

Type -d-d1	Mat.-Nr.	bar	L	D	s	z	e	kg/100
SO 40001-6-4 FIX	016.0015.110	250	11.0	8.5	0.20	1.0	4.5	0.143
SO 40001-8-6 FIX	016.0015.140	150	13.0	10.5	0.25	1.0	6.5	0.230

d=Rohrassen-ø
d1=Rohrinnen-ø
e=kleinste Bohrung
s=Rohrwandstärke

d=ø extérieur du tube
d1=ø intérieur du tube
e=ø-min. de passage
s=épaisseur de la paroi du tube

d=tube outside diameter
d1=tube inside diameter
e=minimum bore
s=tube wall thickness

Abschlusszapfen Bouchon d'arrêt Plug

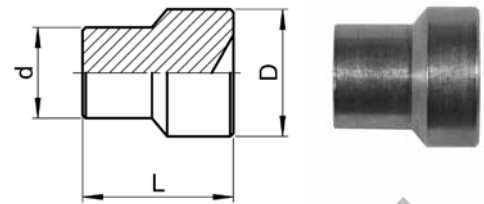

SO 40002

Type -d	Mat.-Nr.	L	D	kg/100
Für metrische Rohre	Pour tubes métriques		For metric tubes	
SO 40002-2	016.0020.020	5.3	5.0	0.040
SO 40002-3	016.0020.030	7.0	5.0	0.080
SO 40002-4	016.0020.040	8.0	6.8	0.150
SO 40002-5	016.0020.050	8.5	6.8	0.190
SO 40002-6	016.0020.060	10.0	8.4	0.320
SO 40002-8	016.0020.080	10.5	10.5	0.570
SO 40002-10	016.0020.100	13.0	12.7	0.970
SO 40002-12	016.0020.120	14.0	14.8	1.550
SO 40002-14/15	016.0020.140	15.0	17.5	2.220
SO 40002-17/18	016.0020.170	17.2	21.0	3.680
SO 40002-22	016.0020.220	19.0	26.0	6.300
SO 40002-28	016.0020.280	22.5	32.5	12.320
SO 40002-35	016.0020.350	25.2	39.5	21.300

Für Zollrohre	Pour tubes pouces		For inch tubes	
SO 40002-6,35	016.0020.063	10.0	8.4	0.330
SO 40002-7,94	016.0020.079	10.5	10.5	0.560
SO 40002-9,52	016.0020.095	13.0	12.7	0.960
SO 40002-12,7	016.0020.127	14.0	14.8	1.550

Umrechnung für "d" bei Zollrohren:

- 6,35 = 1/4
- 7,94 = 5/16
- 9,52 = 3/8
- 12,7 = 1/2

Conversion de "d" pour tubes en pouces:

- 6,35 = 1/4
- 7,94 = 5/16
- 9,52 = 3/8
- 12,7 = 1/2

Conversion for "d" for inch tubes:

- 6,35 = 1/4
- 7,94 = 5/16
- 9,52 = 3/8
- 12,7 = 1/2

Anwendungsbeispiele:



Der Abschlusszapfen lässt sich in jede Verschraubung anstelle eines Klemmringes der gleichen Grösse einsetzen. Wird ein reduzierter Klemmring durch einen Abschlusszapfen ersetzt, so muss immer von der Grösse der Anschlussmutter ausgegangen werden.

Montagehinweis: Anschlussmutter mit 1/4 Umdrehung anziehen.

Exemples d'utilisation:

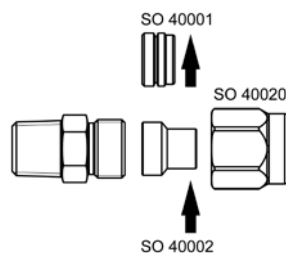

Le bouchon d'arrêt s'insère dans tout raccord au lieu d'une bague de serrage de la même taille. Si une bague de serrage de réduction est remplacée par un bouchon d'arrêt, la taille de l'écrou de raccordement doit toujours être prise en compte.

Note d'installation: Serrez l'écrou d'accouplement de 1/4 de tour.

Sample combinations:

The plug can be inserted into all unions instead of a compression ferrule of the same size. If a reduction compression ferrule is replaced by a plug, the size of the union nut must be used as a basis.

Assembly information: Tighten the union nut with 1/4 turn.

Stützhülse

zur Rohrverstärkung

Douille d'appui

pour renforcer les tubes

Stiffener sleeve

to reinforce tubes

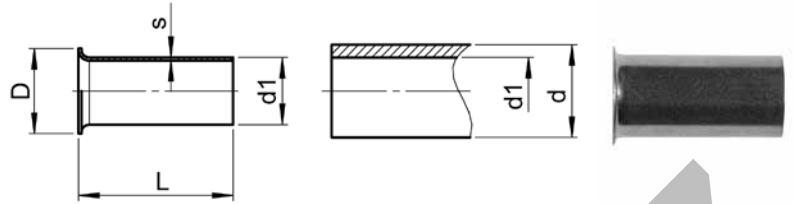

SO 40003

Type - d - d1	Mat.-Nr.	L	D	s	kg/100
Für metrische Rohre	Pour tubes métriques			For metric tubes	
SO 40003-3-2	016.0030.020	6.0	2.8	0.20	0.006
SO 40003-3-2,4	016.0030.024	6.0	2.8	0.20	0.007
SO 40003-4-2	016.0030.030	8.0	3.8	0.20	0.008
SO 40003-4-2,5	016.0030.035	8.0	3.8	0.20	0.010
SO 40003-4-3	016.0030.040	8.0	3.8	0.20	0.010
SO 40003-5-3	016.0030.060	8.0	4.5	0.20	0.015
SO 40003-5-3,5	016.0030.075	8.0	4.5	0.20	0.020
SO 40003-6-3	016.0030.100	10.0	5.2	0.20	0.015
SO 40003-6-4	016.0030.110	10.0	5.5	0.20	0.025
SO 40003-6-4,4	016.0030.113	10.0	5.5	0.20	0.025
SO 40003-6-4,65	016.0030.116	10.0	5.5	0.20	0.025
SO 40003-6-4,7 D	016.0030.118	10.0	5.5	0.40	0.046
SO 40003-8-5	016.0030.136	12.0	7.5	0.25	0.040
SO 40003-8-5,5	016.0030.138	12.0	7.5	0.25	0.045
SO 40003-8-6	016.0030.140	12.0	7.5	0.25	0.045
SO 40003-8-6,4	016.0030.144	12.0	7.5	0.25	0.050
SO 40003-10-7	016.0030.180	16.0	9.5	0.30	0.080
SO 40003-10-7,5	016.0030.185	16.0	9.5	0.30	0.090
SO 40003-10-8 D	016.0030.189	16.0	9.5	0.60	0.190
SO 40003-10-8	016.0030.190	16.0	9.5	0.30	0.100
SO 40003-10-8,4	016.0030.192	16.0	9.5	0.30	0.095
SO 40003-10-8,6	016.0030.193	16.0	9.5	0.30	0.095
SO 40003-12-9	016.0030.230	20.0	11.5	0.40	0.190
SO 40003-12-9,5	016.0030.235	20.0	11.5	0.40	0.195
SO 40003-12-10	016.0030.240	20.0	11.5	0.40	0.195
SO 40003-12-10,4	016.0030.254	20.0	11.5	0.40	0.195
SO 40003-12-11 D	016.0030.257	20.0	12.0	1.00	0.500
SO 40003-13-11 D	016.0030.279	20.0	12.5	1.00	0.530
SO 40003-13-11	016.0030.280	20.0	12.5	0.50	0.330
SO 40003-14-11	016.0030.330	20.0	12.5	0.50	0.330
SO 40003-14-11,5	016.0030.335	24.0	13.5	0.50	0.350
SO 40003-14-12	016.0030.340	24.0	13.5	0.50	0.370
SO 40003-15-12,5	016.0030.425	24.0	14.5	0.50	0.390
SO 40003-15-13	016.0030.430	24.0	14.5	0.50	0.390
SO 40003-16-13,5	016.0030.495	26.0	15.5	0.50	0.430
SO 40003-16-14 D	016.0030.499	26.0	15.5	1.00	0.900
SO 40003-16-14	016.0030.500	26.0	15.5	0.50	0.470
SO 40003-17-15	016.0030.540	26.0	16.5	0.60	0.590
SO 40003-18-15	016.0030.610	26.0	16.5	0.60	0.590
SO 40003-18-15,6	016.0030.616	26.0	17.5	0.60	0.610
SO 40003-18-16	016.0030.620	26.0	17.5	0.60	0.630
SO 40003-19-17	016.0030.640	28.0	18.5	0.60	0.820
SO 40003-19-17 D	016.0030.642	28.0	19.0	1.00	1.140

Fortsetzung nächste Seite

Suite à la prochaine page

Continued on next page

d=Rohraussen-ø
d1=Rohrinnen-ø
s=Rohrwandstärke

d=ø extérieur du tube
d1=ø intérieur de tube
s=épaisseur de la paroi du tube

d=tube outside diameter
d1=tube inside diameter
s=tube wall thickness

Stützhülse

zur Rohrverstärkung

Douille d'appui

pour renforcer les tubes

Stiffener sleeve

to reinforce tubes

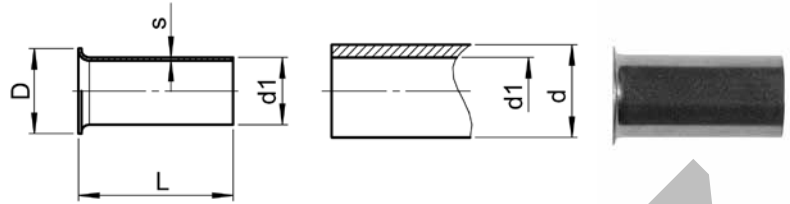

SO 40003

Type -d-d1	Mat.-Nr.	L	D	s	kg/100
Für metrische Rohre	Pour tubes métriques			For metric tubes	
SO 40003-20-18	016.0030.700	28.0	19.5	0.60	0.830
SO 40003-22-19	016.0030.760	30.0	21.5	0.60	0.850
SO 40003-22-19,6	016.0030.771	30.0	21.5	0.60	0.940
SO 40003-22-20	016.0030.775	30.0	21.5	0.60	0.980
SO 40003-28-25	016.0030.870	36.0	27.5	0.80	1.500
SO 40003-28-25,6	016.0030.876	36.0	27.5	0.80	1.600
SO 40003-35-32	016.0030.890	41.0	34.0	0.85	2.500

Für Zollrohre	Pour tubes pouces			For inch tubes	
SO 40003-6,35-4,3	016.0030.112	10.0	5.5	0.20	0.023
SO 40003-9,52-6,35	016.0030.160	16.0	9.0	0.30	0.080
SO 40003-12,7-10,7	016.0030.269	20.0	12.5	0.50	0.200
SO 40003-12,7-10,9	016.0030.271	20.0	12.5	0.50	0.286
SO 40003-15,88-14,25 D	016.0030.465	26.0	15.5	0.50	0.916

Umrechnung für "d" bei Zollrohren:

6,35 = 1/4
 9,52 = 3/8
 12,7 = 1/2
 15,88 = 5/8

Conversion de "d" pour tubes en pouces:

6,35 = 1/4
 9,52 = 3/8
 12,7 = 1/2
 15,88 = 5/8

Conversion for "d" for inch tubes:

6,35 = 1/4
 9,52 = 3/8
 12,7 = 1/2
 15,88 = 5/8

Werkstoff: Messing CW508L

Matériau: Laiton CW508L

Material: Brass CW508L

Verstärken:

Dünnwandige und weiche Rohre sowie alle Kunststoffrohre sind mit Stützhülsen zu verstärken.

Genauere Angaben über das Verstärken siehe Kapitel i.

Hilfswerkzeuge zum Entgraten und Kalibrieren der Rohre siehe Kapitel 21.

Typenbezeichnung mit D: für weiches oder sehr dünnwandiges Kupferrohr.

Renforcement:

Tubes à paroi mince et tubes souples ainsi que tubes en plastique doivent être renforcés à l'aide de douilles d'appui.

Pour des indications concernant le renforcement voir chapitre i.

Pour des outils pour l'ébarbage et le calibrage du tube voir chapitre 21.

Types avec D: pour des tubes de cuivre mous ou à parois très minces.

Reinforcement:

Thin walled, soft tubes and all plastic tubes are to be reinforced with stiffener sleeves.

Details concerning stiffening are to be found in chapter i.

For useful tools for deburring and calibrating tubes see chapter 21.

Types with D: for soft or very thin-walled copper tubes.

Dichtung für Innengewinde

Joint pour taraudage

Washer for female threads

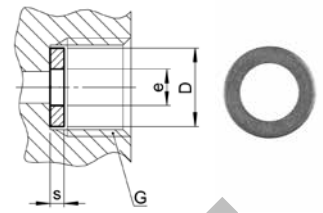

SO 40005

Type -d -G	Mat.-Nr.	D	s	e	kg/100
G=Rohrgewinde (zylindrisch)		G=Filetage-gaz BSP (cylindrique)		G=BSP thread (parallel)	
SO 40005-4-1/8	016.0050.060	8.5	2.00	4.0	0.070
SO 40005-5-1/8	016.0050.082	8.5	2.00	4.0	0.070
SO 40005-6-1/4	016.0050.110	11.2	2.00	5.2	0.130
SO 40005-8-1/4	016.0050.170	11.2	2.00	6.8	0.090
SO 40005-8,2-1/4	016.0050.173	11.2	2.00	8.2	0.080
SO 40005-10-3/8	016.0050.280	14.8	2.00	9.0	0.170
SO 40005-10,2-3/8	016.0050.283	14.8	2.00	10.2	0.150
SO 40005-12-1/2	016.0050.400	18.5	2.00	10.0	0.330
SO 40005-14-1/2	016.0050.504	18.5	2.00	13.5	0.210
SO 40005-15-1/2	016.0050.534	18.5	2.00	13.5	0.210
SO 40005-15-3/4	016.0050.536	24.0	2.00	14.2	0.490
SO 40005-17-3/4	016.0050.598	24.0	2.00	16.2	0.410
SO 40005-18-7/8	016.0050.650	27.8	2.00	16.2	0.700
SO 40005-22-1	016.0050.770	30.0	2.00	20.0	0.670

Anwendungsbeispiele:

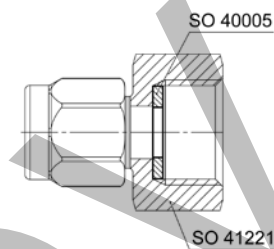

Material: Kupfer weich

Zu verwenden:
 Als stirnseitige Abdichtung in Anschlussgewinden bei Verschraubungen z.B. SO 41221 und bei Übergangsmuffe SO 40030 (nicht abgebildet).
 Als Auflage für den Klemmring bei Verwendung von Einschraubstutzen SO 41001.

Exemples d'utilisation:

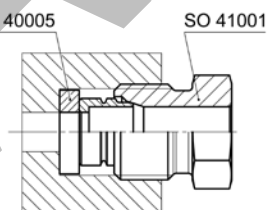

Matériau: Cuivre mou

Pour l'utilisation:
 Comme l'étanchéité de la façade dans les filets au niveau des raccords à vis par exemple SO 41221 et au niveau de l'adaptateur femelle SO 40030 (non illustré).
 Comme support de la bague de serrage pour l'utilisation d'écrou de raccord mâle SO 41001.

Sample combinations:

Material: Soft copper

Use:
 As a face side seal in connecting threads for screw fittings, e.g. SO 41221 and for female adaptor SO 40030 (not illustrated).
 As a support for the compression ferrule if the nipple connection SO 41001 is used.

Sechskantmutter METR
Ecrou à six pans METR
Hexagon nut METR

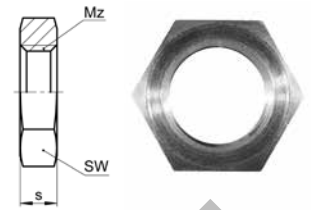

SO 40006 METR

Type -Mz	Mat.-Nr.	SW	s	kg/100
Mz=metrisches Gewinde (zylindrisch)	Mz=Filetage métrique (cylindrique)	Mz=Metric thread (parallel)		
SO 40006-M8x1	016.0063.120	12	3.50	0.220
SO 40006-M10x1	016.0063.150	14	4.00	0.270
SO 40006-M12x1	016.0063.190	17	4.00	0.460
SO 40006-M14x1	016.0063.220	19	4.00	0.530
SO 40006-M16x1	016.0063.260	19	4.00	0.380
SO 40006-M20x1	016.0063.340	24	4.50	0.690
SO 40006-M20x1,5	016.0063.345	27	6.00	1.640
SO 40006-M24x1,5	016.0063.405	27	7.00	1.140
SO 40006-M28x1,5	016.0063.445	36	8.00	3.760

Sechskantmutter für SO 41521, SO 41524, SO 42721 und Ventile

Ecrou à six pans pour SO 41521, SO 41524, SO 42721 et vannes

Hexagon nut for SO 41521, SO 41524, SO 42721 and valves

Dichtung für Aussengewinde METR
Joint pour filetage METR
Washer for male thread METR

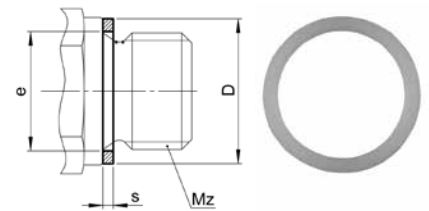

SO 40507 METR

Type -Mz	Mat.-Nr.	D	s	e	kg/100
Mz=metrisches Gewinde (zylindrisch)	Mz=Filetage métrique (cylindrique)	Mz=Metric thread (parallel)			
SO 40507-M5	016.0075.080	8.0	1.00	5.2	0.005
SO 40507-M5-2	016.0075.083	8.0	2.00	5.2	0.010
SO 40507-M6	016.0075.100	9.0	1.00	6.2	0.004
SO 40507-M8/G1/16"	016.0075.120	10.0	1.00	8.2	0.003
SO 40507-M10/G1/8"	016.0075.150	12.0	1.00	10.2	0.006

Material: Kunststoff POM

Matériau: Plastique POM

Material: Plastic POM

Dichtung für Aussengewinde

Joint pour filetage

Washer for male thread

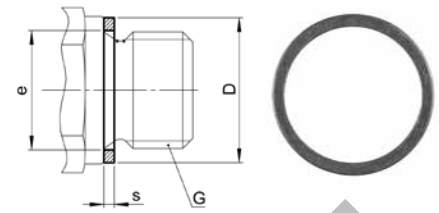

SO 40007

Type -G	Mat.-Nr.	D	s	e	kg/100
G=Rohrgewinde (zylindrisch)	G=Filetage-gaz BSP (cylindrique)	G=BSP thread (parallel)			
SO 40007-1/8	016.0070.020	13.4	1.50	10.2	0.050
SO 40007-1/4	016.0070.040	17.9	1.50	14.2	0.110
SO 40007-3/8	016.0070.060	21.0	1.50	17.2	0.130
SO 40007-1/2	016.0070.080	25.9	1.50	21.2	0.220
SO 40007-3/4	016.0070.120	31.0	1.50	26.5	0.230

Dichtung für Aussengewinde METR

Joint pour filetage METR

Washer for male thread METR

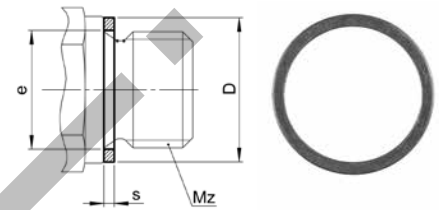

SO 40007 METR

Type -Mz	Mat.-Nr.	D	s	e	kg/100
Mz=metrisches Gewinde (zylindrisch)	Mz=Filetage métrique (cylindrique)	Mz=Metric thread (parallel)			
SO 40007-M5	016.0073.080	8.0	1.00	5.0	0.023
SO 40007-M6	016.0073.100	8.0	1.00	6.2	0.014
SO 40007-M8	016.0073.173	11.2	2.00	8.2	0.080
SO 40007-M10	016.0073.150	13.4	1.50	10.2	0.050
SO 40007-M12	016.0073.190	15.4	1.50	12.2	0.080
SO 40007-M14	016.0073.220	17.9	1.50	14.2	0.110
SO 40007-M16	016.0073.260	19.9	1.50	16.2	0.120
SO 40007-M18	016.0073.300	21.7	1.50	18.2	0.140
SO 40007-M22	016.0073.370	27.0	1.50	22.2	0.225

Anwendungsbeispiele:

Exemples d'utilisation:

Sample combinations:

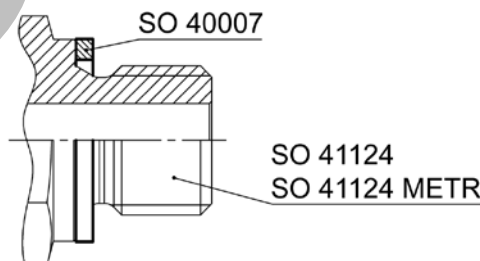

Material: Kupfer weich

Ersatzdichtungen für Schwenkverschraubungen und Mehrfachverteiler.

Zu verwenden:

Als Abdichtung der Verschraubung mit zylindrischem Einschraubgewinde.

Matériau: Cuivre mou

Joints de rechange pour coudes banjo et coudes banjo multiples.

Emploi:

Rendre étanche à un filetage cylindrique mâle.

Material: Soft copper

Replacement washer for single and double banjo.

Application:

As seal for union with straight male adaptor thread.

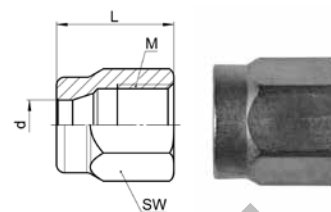
Anschlussmutter
Ecrou
Union nut

SO 40020

Type -d	Mat.-Nr.	bar	M	SW	L	kg/100
Für metrische Rohre	Pour tubes métriques		For metric tubes			
SO 40020-2	016.0200.020	125	6x0.75	8	8.5	0.245
SO 40020-3	016.0200.030	125	6x0.75	8	10.0	0.270
SO 40020-4	016.0200.040	125	8x1.0	10	13.0	0.510
SO 40020-5	016.0200.050	125	8x1.0	10	13.5	0.500
SO 40020-6	016.0200.060	250	10x1.0	12	14.5	0.720
SO 40020-8	016.0200.080	150	12x1.0	14	16.0	0.950
SO 40020-10	016.0200.100	125	14x1.0	17	18.5	1.640
SO 40020-12	016.0200.120	100	16x1.0	19	20.0	2.010
SO 40020-14	016.0200.140	40	20x1.5	24	21.5	4.050
SO 40020-15	016.0200.150	40	20x1.5	24	21.5	3.730
SO 40020-16	016.0200.160	40	24x1.5	27	24.0	4.790
SO 40020-17	016.0200.170	40	24x1.5	27	24.0	4.680
SO 40020-18	016.0200.180	40	24x1.5	27	24.0	4.350
SO 40020-22	016.0200.220	25	28x1.5	32	27.0	7.150
SO 40020-28	016.0200.280	16	36x2.0	41	32.0	14.300
SO 40020-35	016.0200.350	16	42x2.0	50	36.0	26.200

Für Zollrohre	Pour tubes pouces		For inch tubes			
SO 40020-3,2	016.0200.032	125	6x0.75	8	10.0	0.270
SO 40020-6,35	016.0200.063	250	10x1.0	12	14.5	0.710
SO 40020-7,94	016.0200.079	150	12x1.0	14	16.0	0.950
SO 40020-9,52	016.0200.095	125	14x1.0	17	18.5	1.730
SO 40020-15,88	016.0200.158	40	24x1.5	27	24.0	4.790
SO 40020-22,22	016.0200.222	25	28x1.5	32	27.0	7.020

Umrechnung für "d" bei Zollrohren:

3,2 = 1/8
 6,35 = 1/4
 7,94 = 5/16
 9,52 = 3/8
 15,88 = 5/8
 22,22 = 7/8

Conversion de "d" pour tubes en pouces:

3,2 = 1/8
 6,35 = 1/4
 7,94 = 5/16
 9,52 = 3/8
 15,88 = 5/8
 22,22 = 7/8

Conversion for "d" for inch tubes:

3,2 = 1/8
 6,35 = 1/4
 7,94 = 5/16
 9,52 = 3/8
 15,88 = 5/8
 22,22 = 7/8

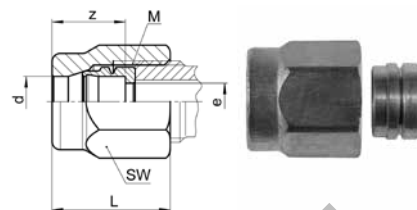
Armaturenanschluss
Ecrou et bague de raccordement
Nut connection

SO 40021

Type-d	Mat.-Nr.	bar	M	SW	L	z	e	kg/100
Für metrische Rohre	Pour tubes métriques			For metric tubes				
SO 40021-2	016.0210.020	125	6x0.75	8	8.5	4.0	1.5	0.260
SO 40021-3	016.0210.030	125	6x0.75	8	10.0	5.0	2.5	0.300
SO 40021-4	016.0210.040	125	8x1.0	10	13.0	6.0	3.4	0.570
SO 40021-5	016.0210.050	125	8x1.0	10	13.5	6.5	4.0	0.560
SO 40021-6	016.0210.060	250	10x1.0	12	14.5	7.5	4.5	0.840
SO 40021-8	016.0210.080	150	12x1.0	14	16.0	8.0	6.5	1.120
SO 40021-10	016.0210.100	125	14x1.0	17	18.5	10.0	8.5	1.890
SO 40021-12	016.0210.120	100	16x1.0	19	20.0	11.0	10.0	2.340
SO 40021-14	016.0210.140	40	20x1.5	24	21.5	12.5	12.0	4.560
SO 40021-15	016.0210.150	40	20x1.5	24	21.5	12.5	13.0	4.240
SO 40021-16	016.0210.160	40	24x1.5	27	24.0	14.0	14.0	5.300
SO 40021-17	016.0210.170	40	24x1.5	27	24.0	14.0	15.0	5.530
SO 40021-18	016.0210.180	40	24x1.5	27	24.0	14.0	16.0	5.260
SO 40021-22	016.0210.220	25	28x1.5	32	27.0	17.5	20.0	8.420
SO 40021-28	016.0210.280	16	36x2.0	41	32.0	19.5	24.0	16.700
SO 40021-35	016.0210.350	16	42x2.0	50	36.0	22.0	32.5	29.200

Für Zollrohre	Pour tubes pouces			For inch tubes				
SO 40021-3,2	016.0210.032	125	6x0.75	8	10.0	5.0	2.5	0.300
SO 40021-6,35	016.0210.063	250	10x1.0	12	14.5	7.5	4.5	0.830
SO 40021-7,94	016.0210.079	150	12x1.0	14	16.0	8.0	6.5	1.120
SO 40021-9,52	016.0210.095	125	14x1.0	17	18.5	10.0	8.0	1.950
SO 40021-15,88	016.0210.158	40	24x1.5	27	24.0	14.0	14.0	5.300
SO 40021-22,22	016.0210.222	25	28x1.5	32	27.0	17.5	20.0	8.300

Umrechnung für "d" bei Zollrohren:

3,2 = 1/8
 6,35 = 1/4
 7,94 = 5/16
 9,52 = 3/8
 15,88 = 5/8
 22,22 = 7/8

Conversion de "d" pour tubes en pouces:

3,2 = 1/8
 6,35 = 1/4
 7,94 = 5/16
 9,52 = 3/8
 15,88 = 5/8
 22,22 = 7/8

Conversion for "d" for inch tubes:

3,2 = 1/8
 6,35 = 1/4
 7,94 = 5/16
 9,52 = 3/8
 15,88 = 5/8
 22,22 = 7/8

Armaturenanschluss reduziert

Ecrou et bague de raccordement réduite

Reduction nut connection

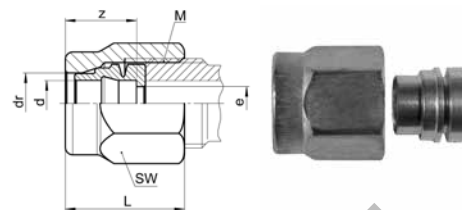

SO 40021 RED

Type-dr-d	Mat.-Nr.	bar	M	SW	L	z	e	kg/100
Für metrische Rohre	Pour tubes métriques			For metric tubes				
SO 40021-5-3	016.0214.060	125	8x1.0	10	13.5	6.5	2.5	0.620
SO 40021-6-4	016.0214.110	100	10x1.0	12	14.5	7.5	3.4	0.950
SO 40021-6-5	016.0214.117	100	10x1.0	12	14.5	7.5	4.0	0.900
SO 40021-8-6	016.0214.140	250	12x1.0	14	16.0	8.0	4.5	1.280
SO 40021-10-8	016.0214.190	150	14x1.0	17	18.5	10.0	6.5	2.090
SO 40021-12-10	016.0214.240	100	16x1.0	19	20.0	11.0	8.5	2.620
SO 40021-14-12	016.0214.340	40	20x1.5	24	21.5	12.5	10.0	4.940
SO 40021-15-12	016.0214.420	40	20x1.5	24	21.5	12.5	10.0	4.780
SO 40021-15-13	016.0214.430	40	20x1.5	24	21.5	12.5	11.0	4.670
SO 40021-17-14	016.0214.530	40	24x1.5	27	24.0	14.0	12.0	6.240
SO 40021-18-15	016.0214.610	40	24x1.5	27	24.0	14.0	13.0	6.010
SO 40021-18-16	016.0214.620	40	24x1.5	27	24.0	14.0	14.0	5.780
SO 40021-22-17	016.0214.750	25	28x1.5	32	27.0	17.5	15.0	10.180
SO 40021-22-18	016.0214.755	25	28x1.5	32	27.0	17.5	16.0	10.400
SO 40021-22-19	016.0214.760	25	28x1.5	32	27.0	17.5	16.0	10.175

Für Zollrohre	Pour tubes pouces			For inch tubes				
SO 40021-4-3,2	016.0214.042	125	8x1.0	10	13.0	6.0	2.5	0.600
SO 40021-10-7,94	016.0214.187	64	14x1.0	17	18.5	10.0	6.5	2.090
SO 40021-15-12,7	016.0214.427	40	20x1.5	24	21.0	12.5	11.0	4.670
SO 40021-18-15,88	016.0214.618	40	24x1.5	27	23.0	14.0	14.0	5.780
SO 40021-22-19,05	016.0214.762	25	28x1.5	32	27.5	17.5	17.0	10.175

Umrechnung für "d" bei Zollrohren:

3,2 = 1/8
 7,94 = 5/16
 12,7 = 1/2
 15,88 = 5/8
 19,05 = 3/4

Conversion de "d" pour tubes en pouces:

3,2 = 1/8
 7,94 = 5/16
 12,7 = 1/2
 15,88 = 5/8
 19,05 = 3/4

Conversion for "d" for inch tubes:

3,2 = 1/8
 7,94 = 5/16
 12,7 = 1/2
 15,88 = 5/8
 19,05 = 3/4

Anwendungsbeispiele:

Mit diesem Armaturenanschluss können einstufige Reduktionen vorgenommen werden. Die Anschlussgewindegrößen sind im Kapitel i aufgeführt.

Exemples d'utilisation:

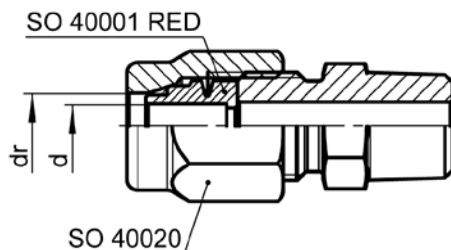

Avec cet écrou de raccordement, les réductions à une étape peuvent être faites. Les tailles des filets sont listées dans le chapitre i.

Sample combinations:

Single stage reductions can be made with this nut connection. The connecting threads are listed in chapter i.

Manometeranschluss
Ecrou de manomètre
Nut connection for pressure gauge

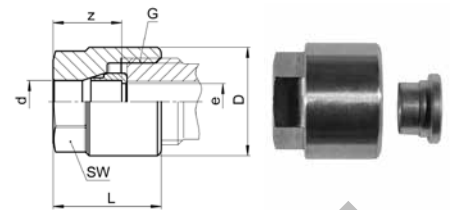

SO 00021 MAN

Type -d -G	Mat.-Nr.	bar	SW	L	D	z	e	kg/100
G=Rohrgewinde (zylindrisch)								
			G=Filetage-gaz BSP (cylindrique)					
						G=BSP thread (parallel)		
SO 00021-6-¼ MAN	246.0211.110	125	14	20.0	17.0	8.5	5.5	2.190
SO 00021-6-½ MAN	246.0211.125	125	22	25.5	26.0	8.5	5.0	6.810
SO 00021-8-¼ MAN	246.0211.170	125	14	19.0	17.0	10.5	7.0	2.000
SO 00021-8-½ MAN	246.0211.185	125	22	26.0	26.0	10.0	6.5	6.820
SO 00021-10-½ MAN	246.0211.285	100	19	24.0	26.0	12.0	9.0	5.500
SO 00021-12-½ MAN	246.0211.400	100	19	26.0	26.0	14.0	11.0	5.640

Anwendungsbeispiele:

Exemples d'utilisation:

Sample combinations:

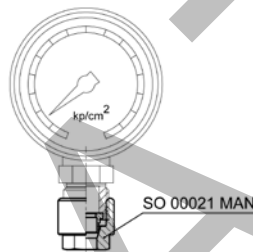

Gewindezapfen für SERTO-Anschlüsse siehe Kapitel i.

Embout fileté par écrous de raccordement SERTO voir chapitre i.

Threaded stem for SERTO connections see chapter i.

Übergangsmuffe Adaptateur femelle Female adaptor

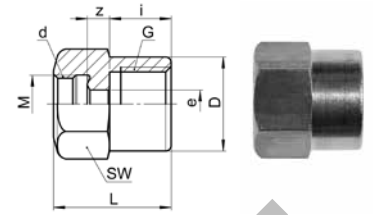

SO 40030

Type -d-G	Mat.-Nr.	bar	M	SW	L	D	i	z	e	kg/100
G=Rohrgewinde (zylindrisch)	G=Filetage-gaz BSP (cylindrique)	G=BSP thread (parallel)								
SO 40030-6-1/8	016.0301.100	250	10x1.0	14	20.0	13.8	10.0	4.0	5.0	1.670
SO 40030-6-1/4	016.0301.110	250	10x1.0	17	21.0	16.8	11.0	4.0	5.0	2.530
SO 40030-6-3/8	016.0301.120	250	10x1.0	22	22.0	21.8	12.0	4.0	5.0	4.800
SO 40030-8-1/8	016.0301.160	150	12x1.0	17	21.0	16.8	10.0	4.0	6.5	2.790
SO 40030-8-1/4	016.0301.170	150	12x1.0	17	23.0	16.8	11.0	5.0	6.5	2.540
SO 40030-8-3/8	016.0301.180	150	12x1.0	22	23.0	21.8	12.0	4.0	6.5	4.780
SO 40030-10-1/4	016.0301.270	125	14x1.0	17	22.0	16.8	11.0	4.0	8.5	2.090
SO 40030-10-3/8	016.0301.280	125	14x1.0	22	23.0	21.8	12.0	5.0	8.5	4.760
SO 40030-12-1/4	016.0301.380	100	16x1.0	19	22.0	18.8	11.0	4.0	10.5	2.780
SO 40030-12-3/8	016.0301.390	100	16x1.0	22	23.0	21.8	12.0	4.0	10.5	4.090
SO 40030-12-1/2	016.0301.400	100	16x1.0	27	25.0	26.8	14.0	4.0	10.5	7.270
SO 40030-15-3/8	016.0301.532	40	20x1.5	24	25.0	23.8	12.0	5.0	13.0	5.100
SO 40030-15-1/2	016.0301.534	40	20x1.5	27	27.0	26.8	14.0	5.0	13.0	7.130
SO 40030-15-3/4	016.0301.536	40	20x1.5	32	30.0	31.8	17.0	5.0	13.0	10.980
SO 40030-18-1/2	016.0301.646	40	24x1.5	30	28.0	29.8	14.0	6.0	15.0	9.410
SO 40030-18-3/4	016.0301.648	40	24x1.5	32	31.0	31.8	17.0	6.0	15.0	10.350
SO 40030-22-3/4	016.0301.768	25	28x1.5	36	31.0	35.8	17.0	6.0	19.0	14.320
SO 40030-28-1	016.0301.850	16	36x2.0	41	37.0	40.8	20.0	7.0	25.0	16.700
SO 40030-35-1 1/4	016.0301.944	16	42x2.0	50	41.0	49.8	22.0	7.0	31.0	27.400

Anwendungsbeispiele:

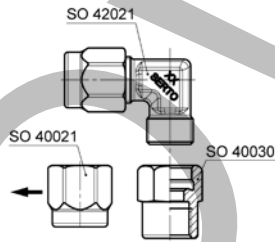

Die Übergangsmuffe kann auf jedes SERTO-Formteil mit dem passenden zylindrischen Gewinde geschraubt werden und muss mit 1/4 Umdrehung angezogen werden.

Dichtungsprinzip: Bei der Montage drückt sich die Dichtkante des Übergangsstückes in das SERTO-Formteil ein, dadurch entsteht eine einwandfreie Dichtung.

Wir empfehlen, das Gewinde mit einem geeigneten Flüssigklebstoff gegen unbeabsichtigtes Lösen zu sichern.

Exemples d'utilisation:

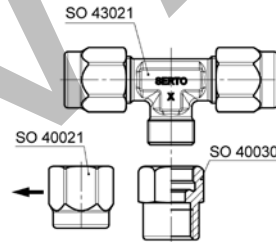

L'adaptateur femelle peut être vissé à toute pièce moulée SERTO avec le filetage cylindrique approprié et doit être serré de 1/4 de tour.

Principe d'étanchéité: Lors de l'assemblage, l'arête d'étanchéité de l'adaptateur appuie sur la pièce moulée SERTO, créant ainsi une étanchéité parfaite.

Nous recommandons de fixer le filetage avec une colle liquide appropriée pour empêcher le desserrage involontaire.

Sample combinations:

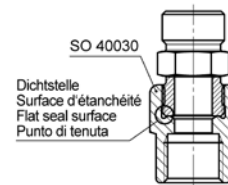

The female adaptor can be screwed onto all SERTO moulded parts with a matching cylindrical thread and must be tightened with 1/4 turn.

Sealing principle: During assembly, the sealing edge of the female adaptor presses into the SERTO moulded part to produce a perfect seal.

We recommend that the thread is secured against accidental unscrewing by means of a suitable liquid adhesive.

Übergangsnippel Adaptateur femelle - mâle Male adaptor

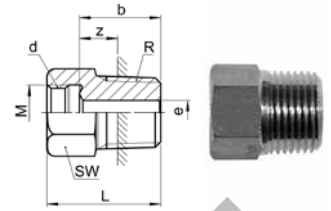

SO 40040

Type -d -R	Mat.-Nr.	bar	M	SW	L	b	z	e	kg/100
R=Rohrgewinde (kegelig)	R=Filetage-gaz BSP (conique)	R=BSP thread (tapered)							
SO 40040-6-1/8	016.0401.100	250	10x1.0	12	17.0	11.0	6.0	5.0	0.800
SO 40040-6-1/4	016.0401.110	250	10x1.0	14	21.0	15.0	7.0	5.0	1.850
SO 40040-6-3/8	016.0401.120	250	10x1.0	17	20.0	14.0	6.0	5.0	2.440
SO 40040-6-1/2	016.0401.125	250	10x1.0	22	23.0	17.0	7.0	5.0	5.700
SO 40040-8-1/8	016.0401.160	150	12x1.0	14	18.0	11.0	6.0	6.5	0.990
SO 40040-8-1/4	016.0401.170	150	12x1.0	14	22.0	15.0	7.0	6.5	1.520
SO 40040-8-3/8	016.0401.180	150	12x1.0	17	22.0	15.0	7.0	6.5	2.970
SO 40040-10-1/4	016.0401.270	125	14x1.0	17	22.0	15.0	7.0	8.5	1.710
SO 40040-10-3/8	016.0401.280	125	14x1.0	17	22.0	15.0	7.0	8.5	2.440
SO 40040-10-1/2	016.0401.285	125	14x1.0	22	23.0	16.0	6.0	8.5	5.030
SO 40040-12-1/4	016.0401.380	100	16x1.0	19	23.0	16.0	8.0	8.5	2.110
SO 40040-12-3/8	016.0401.390	100	16x1.0	19	23.0	16.0	8.0	10.5	2.870
SO 40040-12-1/2	016.0401.400	100	16x1.0	22	26.0	19.0	9.0	10.5	4.840
SO 40040-15-3/8	016.0401.532	40	20x1.5	24	24.0	16.0	8.0	10.5	3.760
SO 40040-15-1/2	016.0401.534	40	20x1.5	24	28.0	20.0	10.0	13.0	4.430
SO 40040-15-3/4	016.0401.536	40	20x1.5	27	27.5	19.5	7.5	13.0	8.250
SO 40040-18-1/2	016.0401.646	40	24x1.5	30	29.0	21.0	11.0	13.0	6.010
SO 40040-18-3/4	016.0401.648	40	24x1.5	30	29.5	21.5	9.5	15.0	8.930
SO 40040-22-1/2	016.0401.764	25	28x1.5	36	29.0	21.0	11.0	15.0	8.910
SO 40040-22-3/4	016.0401.768	25	28x1.5	36	29.5	21.5	9.5	19.0	9.480
SO 40040-28-1	016.0401.850	16	36x2.0	41	36.0	26.0	12.0	24.0	14.900
SO 40040-35-1 1/4	016.0401.944	16	42x2.0	50	42.0	30.0	16.0	31.0	26.600

Anwendungsbeispiele:

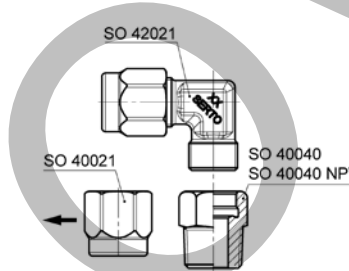

Exemples d'utilisation:

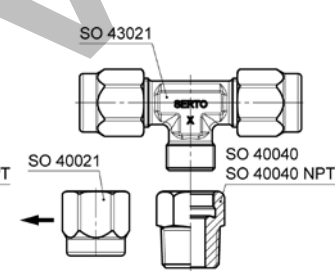

Sample combinations:

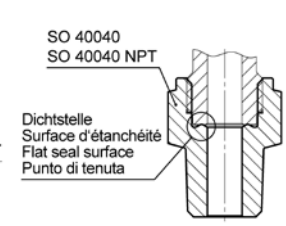

Der Übergangsnippel kann auf jedes SERTO-Formteil mit dem passenden zylindrischen Gewinde geschraubt werden und muss mit 1/4 Umdrehung angezogen werden.

Dichtungsprinzip: Bei der Montage drückt sich die Dichtkante des Übergangsstückes in das SERTO-Formteil ein, dadurch entsteht eine einwandfreie Dichtung. Wir empfehlen, das Gewinde mit einem geeigneten Flüssigklebstoff gegen unbeabsichtigtes Lösen zu sichern.

L'adaptateur mâle peut être vissé à toute pièce moulée SERTO avec le filetage cylindrique approprié et doit être serré de 1/4 de tour.

Principe d'étanchéité: Lors de l'assemblage, l'arête d'étanchéité de l'adaptateur appuie sur la pièce moulée SERTO, créant ainsi une étanchéité parfaite. Nous recommandons de fixer le filetage avec une colle liquide appropriée pour empêcher le desserrage involontaire.

The male adaptor can be screwed onto all SERTO moulded parts with a matching cylindrical thread and must be tightened with 1/4 turn.

Sealing principle: During assembly, the sealing edge of the male adaptor presses into the SERTO moulded part to produce a perfect seal. We recommend that the thread is secured against accidental unscrewing by means of a suitable liquid adhesive.

Übergangsnippel NPT

Adaptateur femelle - mâle NPT

Male adaptor NPT

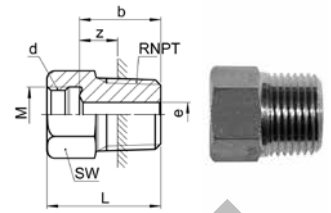

SO 40040 NPT

Type -d -RNPT	Mat.-Nr.	bar	M	SW	L	b	z	e	kg/100
RNPT=NPT Gewinde									

Anwendungsbeispiele:

Exemples d'utilisation:

Sample combinations:

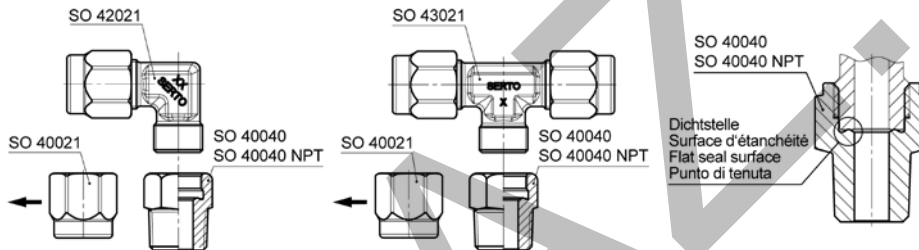

Der Übergangsnippel kann auf jedes SERTO-Formteil mit dem passenden zylindrischen Gewinde geschraubt werden und muss mit 1/4 Umdrehung angezogen werden.

Dichtungsprinzip: Bei der Montage drückt sich die Dichtkante des Übergangsstückes in das SERTO-Formteil ein, dadurch entsteht eine einwandfreie Dichtung. Wir empfehlen, das Gewinde mit einem geeigneten Flüssigklebstoff gegen unbeabsichtigtes Lösen zu sichern.

L'adaptateur mâle peut être vissé à toute pièce moulée SERTO avec le filetage cylindrique approprié et doit être serré de 1/4 de tour.

Principe d'étanchéité: Lors de l'assemblage, l'arête d'étanchéité de l'adaptateur appuie sur la pièce moulée SERTO, créant ainsi une étanchéité parfaite. Nous recommandons de fixer le filetage avec une colle liquide appropriée pour empêcher le desserrage involontaire.

The male adaptor can be screwed onto all SERTO moulded parts with a matching cylindrical thread and must be tightened with 1/4 turn.

Sealing principle: During assembly, the sealing edge of the male adaptor presses into the SERTO moulded part to produce a perfect seal. We recommend that the thread is secured against accidental unscrewing by means of a suitable liquid adhesive.

Schlauchtülle

Douille cannelée

Hose nozzle

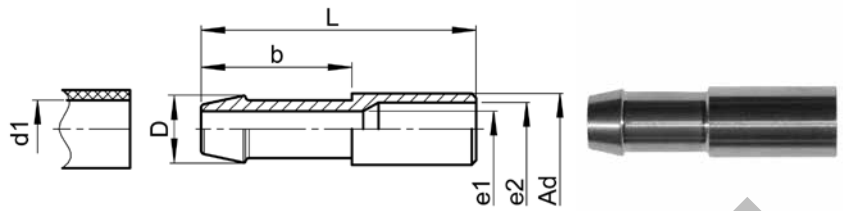

SO 40503

Type -Ad -d1	Mat.-Nr.	L	D	b	e1	e2	kg/100
SO 40503-A4-2,5	016.0500.035	17.0	3.0	8.0	2.0	2.0	0.090
SO 40503-A5-2,5	016.0500.055	17.0	3.0	8.0	2.0	3.0	0.120
SO 40503-A5-3	016.0500.060	18.0	3.8	9.0	2.5	3.0	0.140
SO 40503-A6-2,5	016.0500.095	22.0	3.0	8.0	2.0	4.0	0.210
SO 40503-A6-3	016.0500.100	23.0	3.8	9.0	2.5	4.0	0.260
SO 40503-A6-4	016.0500.110	25.0	5.0	11.0	3.0	4.0	0.270
SO 40503-A6-6	016.0500.122	31.0	7.5	17.0	4.0	4.0	0.480
SO 40503-A6-8	016.0500.121	31.0	9.5	17.0	4.0	4.0	0.804
SO 40503-A8-4	016.0500.132	25.0	5.0	11.0	3.0	6.0	0.275
SO 40503-A8-5	016.0500.136	27.0	6.0	13.0	4.0	6.0	0.324
SO 40503-A8-6	016.0500.140	31.0	7.5	17.0	5.0	6.0	0.520
SO 40503-A8-8	016.0500.154	31.0	9.5	17.0	6.0	6.0	0.710
SO 40503-A8-10	016.0500.157	33.0	11.5	19.0	6.0	6.0	1.392
SO 40503-A10-8	016.0500.190	35.0	9.5	17.0	6.0	8.0	0.720
SO 40503-A10-10	016.0500.198	37.0	11.5	19.0	8.0	8.0	1.370
SO 40503-A10-12	016.0500.199	37.0	13.5	19.0	8.0	8.0	1.918
SO 40503-A10-13	016.0500.200	39.0	15.0	21.0	8.0	8.0	2.443
SO 40503-A12-10	016.0500.240	37.0	11.5	19.0	8.0	9.0	1.230
SO 40503-A12-13	016.0500.260	39.0	15.0	21.0	9.0	9.0	2.889
SO 40503-A15-13	016.0500.430	41.0	15.0	21.0	11.0	12.0	2.050
SO 40503-A18-16	016.0500.620	47.0	18.0	26.0	13.0	15.0	3.240
SO 40503-A22-19	016.0500.760	50.0	21.5	26.0	16.0	19.0	4.590

Anwendungsbeispiele:

Exemples d'utilisation:

Sample combinations:

SO 40503

SO 40021

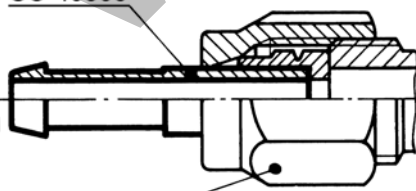

Mit dieser Schlauchtülle können Schläuche und Rohre aus Kunststoff wie z.B. PTFE, PVDF, Polyamid usw. direkt an SERTO-Verschraubungen angeschlossen werden.

Für die Schlauchsicherung verwenden Sie bitte Schlauchklemme SO 40512 (siehe Kapitel 21).

Avec ce douille cannelée, les tuyaux et les tubes en plastique comme p.exp. PTFE, PVDF, polyamide, etc. peuvent être branchés directement au raccord fileté SERTO.

Pour fixer le tuyau, utilisez le collier de serrage SO 40512 (voir chapitre 21).

With this hose nozzle, hoses and tubes made of plastic, e.g. PTFE, PVDF, polyamide etc. can be connected directly to SERTO unions. To secure the hose, use the SO 40512 hose clamp (see chapter 21).

Schlauchtülle vormontiert
Douille cannelée prémontée
Hose nozzle pre-assembled

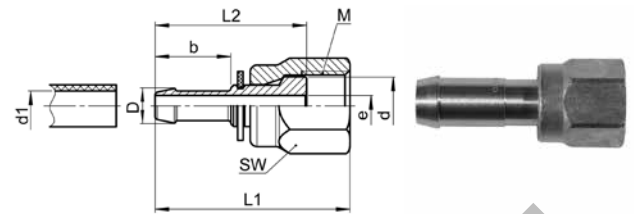

SO 40526

Type -d-d1	Mat.-Nr.	M	SW	L1	L2	D	b	e	kg/100
SO 40526-A5-3	018.0520.060	8x1.0	10	26.0	20.0	3.8	9.0	2.5	0.700
SO 40526-A6-2,5	018.0520.095	10x1.0	12	25.0	19.0	3.0	7.5	2.0	1.050
SO 40526-A6-3	018.0520.100	10x1.0	12	26.0	20.0	3.8	8.0	2.5	1.100
SO 40526-A6-4	018.0520.110	10x1.0	12	28.0	22.0	5.0	10.5	3.0	1.110
SO 40526-A6-8	018.0520.121	10x1.0	12	38.0	32.0	9.5	17.0	4.0	1.115
SO 40526-A6-6	018.0520.122	10x1.0	12	38.0	32.0	7.5	17.0	4.0	1.320
SO 40526-A8-6	018.0520.140	12x1.0	14	36.0	29.0	7.5	16.5	4.0	1.640
SO 40526-A8-8	018.0520.154	12x1.0	14	41.0	32.0	9.5	17.0	6.0	1.830
SO 40526-A8-10	018.0520.157	12x1.0	14	45.0	34.0	11.5	19.0	6.0	2.512
SO 40526-A10-8	018.0520.190	14x1.0	17	39.0	32.0	9.5	16.5	6.0	2.610
SO 40526-A10-10	018.0520.198	14x1.0	17	45.0	38.0	11.5	19.0	7.0	3.260
SO 40526-A10-12	018.0520.199	14x1.0	17	45.0	38.0	13.5	19.0	7.0	3.520
SO 40526-A10-13	018.0520.200	14x1.0	17	45.0	40.0	15.0	21.0	7.0	3.550
SO 40526-A12-10	018.0520.240	16x1.0	19	42.0	35.0	11.5	18.5	7.0	3.570
SO 40526-A15-13	018.0520.430	20x1.5	24	45.0	38.0	15.0	20.5	11.0	6.290
SO 40526-A22-19	018.0520.760	28x1.5	32	56.0	48.0	21.5	25.5	16.0	13.010

Mit dieser Schlauchtülle können Schläuche und Rohre aus Kunststoff wie z.B. PTFE, PVDF, Polyamid usw. direkt an SERTO-Verschraubungen angeschlossen werden. Für die Schlauchsicherung verwenden Sie bitte Schlauchklemme SO 40512 (siehe Kapitel 21).

Montagehinweis: Anschlussmutter mit 1/4 Umdrehung anziehen. Wir empfehlen eine zusätzliche Schmierung auf der Planfläche.

Avec ce douille cannelée, les tuyaux et les tubes en plastique comme p.ex. PTFE, PVDF, polyamide, etc. peuvent être branchés directement au raccord fileté SERTO. Pour fixer le tuyau, utilisez le collier de serrage SO 40512 (voir chapitre 21).

Note d'installation: Serrez l'écrou de 1/4 de tour. Nous recommandons une lubrification supplémentaire sur la surface plane.

With this hose nozzle, hoses and tubes made of plastic, e.g. PTFE, PVDF, polyamide etc. can be connected directly to SERTO unions. To secure the hose, use the SO 40512 hose clamp (see chapter 21).

Assembly information: Tighten the union nut with 1/4 turn. We recommend additional lubrication on the plane surface.

d=Rohrassen-ø
d1=Rohrinnendurchmesser
e=kleinste Bohrung
L=Mass in montiertem Zustand

d=ø extérieur du tube
d1=ø Intérieur du tube
e=ø-min. de passage
L=après montage

d=tube outside diameter
d1=tube inside diameter
e=minimum bore
L=installed length

Anschlussnippel Ecrou de raccordement mâle Nipple connection

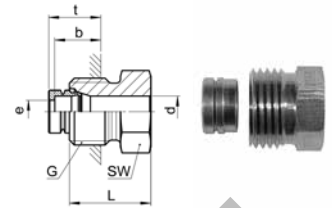

SO 41001

Type -d -G	Mat.-Nr.	bar	SW	L	b	t	e	kg/100
Für metrische Rohre G=Rohrgewinde (zylindrisch)	Pour tubes métriques G=Filetage-gaz BSP (cylindrique)			For metric tubes G=BSP thread (parallel)				
SO 41001-4-1/8	016.1001.060	125	10	12.0	6.0	7.0	3.4	0.590
SO 41001-5-1/8	016.1001.082	125	10	12.0	6.0	7.0	4.0	0.530
SO 41001-6-1/4	016.1001.110	250	14	16.0	8.5	9.5	4.5	1.430
SO 01001-8-1/4	246.1001.170	125	14	16.0	8.5	9.5	6.5	1.160
SO 01001-10-3/8	246.1001.280	100	17	17.0	9.0	10.0	9.0	1.900
SO 41001-12-1/2	016.1001.400	100	22	20.5	12.5	14.0	10.0	4.060
SO 41001-15-1/2	016.1001.534	40	22	19.5	12.5	14.0	13.0	3.010

Für Zollrohre	Pour tubes pouces			For inch tubes				
SO 41001-6,35-1/4	016.1001.140	250	14	16.0	8.5	9.5	4.5	1.400
SO 01001-9,52-3/8	246.1001.235	125	17	17.0	9.0	10.0	8.0	2.100

Umrechnung für "d" bei Zollrohren:

6,35 = 1/4

9,52 = 3/8

Conversion de "d" pour tubes en pouces:

6,35 = 1/4

9,52 = 3/8

Conversion for "d" for inch tubes:

6,35 = 1/4

9,52 = 3/8

Anwendungsbeispiele:

Exemples d'utilisation:

Sample combinations:

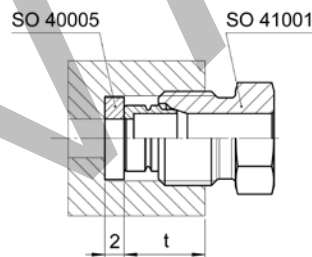

Die entsprechende Kupferdichtung SO 40005 ist immer separat zu bestellen.

Les joints correspondants SO 40005 sont à commander séparément.

The relevant copper washer SO 40005 must always be ordered separately.

Gerade Verschraubung

Union double

Straight union

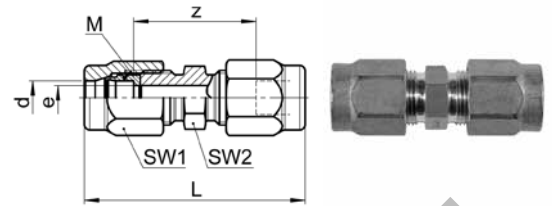

SO 41021

Type -d	Mat.-Nr.	bar	M	SW1	SW2	L	z	e	kg/100
Für metrische Rohre	Pour tubes métriques		For metric tubes						
SO 41021-2	018.1020.020	125	6x0.75	8	7	23.5	15.5	1.5	0.810
SO 41021-3	018.1020.030	125	6x0.75	8	7	26.0	16.0	2.5	0.890
SO 41021-4	018.1020.040	125	8x1.0	10	10	34.0	22.0	3.4	1.770
SO 41021-5	018.1020.050	125	8x1.0	10	10	35.0	22.0	3.4	1.750
SO 41021-6	018.1020.060	250	10x1.0	12	10	37.5	22.0	4.5	2.520
SO 41021-8	018.1020.080	150	12x1.0	14	12	41.0	25.0	6.5	3.530
SO 41021-10	018.1020.100	125	14x1.0	17	14	46.0	26.0	8.5	5.490
SO 41021-12	018.1020.120	100	16x1.0	19	17	48.5	26.5	10.0	7.030
* SO 41021-13	018.1020.130	40	20x1.5	24	22	57.0	31.0	11.0	12.950
SO 41021-14	018.1020.140	40	20x1.5	24	22	57.0	32.0	12.0	13.160
SO 41021-15	018.1020.150	40	20x1.5	24	22	57.0	32.0	13.0	12.520
SO 41021-16	018.1020.160	40	24x1.5	27	24	61.0	33.0	14.0	16.330
SO 41021-17	018.1020.170	40	24x1.5	27	24	61.0	33.0	15.0	16.350
SO 41021-18	018.1020.180	40	24x1.5	27	24	61.0	33.0	15.0	15.810
* SO 41021-19	018.1020.190	25	28x1.5	32	30	69.0	34.0	16.0	27.100
SO 41021-22	018.1020.220	25	28x1.5	32	30	69.0	34.0	19.0	24.380
SO 41021-28	018.1020.280	16	36x2.0	41	36	81.0	42.0	24.0	49.320
SO 41021-35	018.1020.350	16	42x2.0	50	46	92.0	48.0	31.0	81.900
Für Zollrohre	Pour tubes pouces		For inch tubes						
SO 41021-3,2	018.1020.032	125	6x0.75	8	7	26.0	16.0	2.5	0.850
SO 41021-6,35	018.1020.063	250	10x1.0	12	10	37.5	22.0	4.5	2.490
SO 41021-9,52	018.1020.095	125	14x1.0	17	14	46.0	26.0	8.0	5.610
* SO 41021-12,7	018.1020.127	40	20x1.5	24	22	57.0	31.0	11.0	12.950
SO 41021-15,88	018.1020.158	40	24x1.5	27	24	61.0	33.0	14.0	16.330

Umrechnung für "d" bei Zollrohren:

3,2 = 1/8
 6,35 = 1/4
 9,52 = 3/8
 12,7 = 1/2
 15,88 = 5/8

Conversion de "d" pour tubes en pouces:

3,2 = 1/8
 6,35 = 1/4
 9,52 = 3/8
 12,7 = 1/2
 15,88 = 5/8

Conversion for "d" for inch tubes:

3,2 = 1/8
 6,35 = 1/4
 9,52 = 3/8
 12,7 = 1/2
 15,88 = 5/8

Gerade Verschraubung reduziert

Union double réduite

Straight reduction union

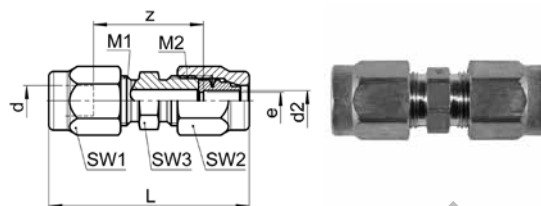

SO 41021 RED

Type -d -d2	Mat.-Nr.	bar	M1	M2	SW1	SW2	SW3	L	z	e	kg/100
Für metrische Rohre	Pour tubes métriques		For metric tubes								
SO 41021-3-2	018.1024.020	125	6x0.75	6x0.75	8	8	8	25.0	15.5	1.5	0.850
* SO 41021-5-3	018.1024.060	125	8x1.0	8x1.0	10	10	10	35.0	22.0	2.5	1.810
SO 41021-5-4	018.1024.080	125	8x1.0	8x1.0	10	10	10	34.5	22.0	3.4	0.560
* SO 41021-6-4	018.1024.110	125	10x1.0	10x1.0	12	12	10	37.5	22.5	3.4	2.630
* SO 41021-6-5	018.1024.117	125	10x1.0	10x1.0	12	12	10	37.5	22.5	4.0	2.580
* SO 41021-8-4	018.1024.132	125	12x1.0	10x1.0	14	12	12	39.5	23.5	3.4	3.500
* SO 41021-8-5	018.1024.136	125	12x1.0	10x1.0	14	12	12	39.5	23.5	4.0	3.500
SO 41021-8-6	018.1024.140	150	12x1.0	10x1.0	14	12	12	39.5	24.0	4.5	3.400
* SO 41021-10-8	018.1024.190	125	14x1.0	14x1.0	17	17	14	46.0	26.5	6.5	5.690
* SO 41021-12-8	018.1024.225	100	20x1.5	14x1.0	24	17	22	51.0	29.5	6.5	7.210
* SO 41021-12-10	018.1024.240	100	16x1.0	16x1.0	19	19	17	48.5	30.0	8.5	7.310
* SO 41021-14-8	018.1024.308	40	20x1.5	14x1.0	24	17	22	51.0	29.5	6.5	6.080
SO 41021-14-10	018.1024.320	40	20x1.5	14x1.0	24	17	22	51.0	29.5	8.5	5.850
* SO 41021-14-12	018.1024.340	40	20x1.5	20x1.5	24	24	22	57.0	32.0	10.0	13.540
* SO 41021-15-8	018.1024.400	40	20x1.5	14x1.0	24	17	22	51.0	29.5	6.5	6.080
SO 41021-15-10	018.1024.410	40	20x1.5	14x1.0	24	17	22	52.0	29.5	8.5	5.850
* SO 41021-15-12	018.1024.420	40	20x1.5	20x1.5	24	24	22	57.0	32.0	10.0	13.060
* SO 41021-15-13	018.1024.430	40	20x1.5	20x1.5	24	24	22	57.0	32.0	11.0	12.950
* SO 41021-16-15	018.1024.510	40	24x1.5	24x1.5	27	27	24	61.0	33.0	13.0	16.400
* SO 41021-17-14	018.1024.530	40	24x1.5	24x1.5	27	27	24	61.0	33.0	12.0	17.060
* SO 41021-18-15	018.1024.610	40	24x1.5	24x1.5	27	27	24	61.0	33.0	13.0	16.560
SO 41021-18-16	018.1024.620	40	24x1.5	24x1.5	27	27	24	61.0	33.0	14.0	16.330
* SO 41021-22-17	018.1024.750	25	28x1.5	28x1.5	32	33	30	69.0	34.0	15.0	26.140
* SO 41021-22-18	018.1024.755	25	28x1.5	28x1.5	32	33	30	69.0	34.0	16.0	25.960
* SO 41021-22-19	018.1024.760	25	28x1.5	28x1.5	32	33	30	69.0	34.0	16.0	25.700

Für Zollrohre	Pour tubes pouces		For inch tubes								
SO 41021-6-6,35	018.1024.119	250	10x1.0	10x1.0	12	12	10	37.5	22.5	4.5	2.480
SO 41021-8-6,35	018.1024.143	150	12x1.0	10x1.0	14	12	12	39.5	24.0	4.5	3.400
SO 41021-10-9,52	018.1024.197	125	14x1.0	14x1.0	17	17	14	46.0	26.5	8.0	5.600
SO 41021-14-9,52	018.1024.312	40	20x1.5	14x1.0	24	17	22	51.0	29.5	8.0	5.780
SO 41021-15-9,52	018.1024.408	40	20x1.5	14x1.0	24	17	22	51.0	29.5	8.0	5.870
* SO 41021-15-12,7	018.1024.427	40	20x1.5	20x1.5	24	24	22	57.0	32.0	11.0	12.950

Umrechnung für "d" bei Zollrohren:

6,35 = 1/4

9,52 = 3/8

12,7 = 1/2

Conversion de "d" pour tubes en pouces:

6,35 = 1/4

9,52 = 3/8

12,7 = 1/2

Conversion for "d" for inch tubes:

6,35 = 1/4

9,52 = 3/8

12,7 = 1/2

Weitere Reduktionen siehe SO 41821

Autres réductions voir SO 41821

Alternative reductions see SO 41821

d=Rohrassen-ø
 e=kleinste Bohrung
 L=Mass in montiertem Zustand
 *=mit reduziertem Klemmring

d=ø extérieur du tube
 e=ø-min. de passage
 L=après montage
 *=avec bague de serrage de réduction

d=tube outside diameter
 e=minimum bore
 L=installed length
 *=with reduction compression ferrule

Gerade Einschraubverschraubung

Union mâle

Male adaptor union

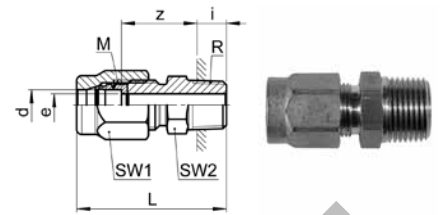

SO 41121

Type -d-R	Mat.-Nr.	bar	M	SW1	SW2	L	i	z	e	kg/100
Für metrische Rohre	Pour tubes métriques		For metric tubes							
R=Rohrgewinde (kegelig)	R=Filetage-gaz BSP (conique)		R=BSP thread (tapered)							
SO 41121-2-1/8	018.1101.020	125	6x0.75	8	10	22.0	5.0	13.0	1.5	0.880
SO 41121-3-1/8	018.1101.040	125	6x0.75	8	10	23.5	5.0	13.5	2.5	0.920
SO 41121-4-1/8	018.1101.060	125	8x1.0	10	10	27.0	5.0	16.0	3.4	1.410
* SO 41121-4-1/4	018.1101.065	125	10x1.0	12	14	34.0	8.0	18.5	3.4	2.930
* SO 41121-4-3/8	018.1101.068	125	10x1.0	12	17	34.5	8.0	19.0	3.4	3.500
SO 41121-5-1/8	018.1101.082	125	8x1.0	10	10	27.5	5.0	16.0	3.5	1.390
* SO 41121-5-1/4	018.1101.084	125	10x1.0	12	14	34.0	8.0	18.5	4.0	2.880
* SO 41121-5-3/8	018.1101.086	125	10x1.0	12	17	34.5	8.0	19.0	4.0	3.450
SO 41121-6-1/8	018.1101.100	250	10x1.0	12	10	28.5	5.0	16.0	4.5	1.690
SO 41121-6-1/4	018.1101.110	250	10x1.0	12	14	34.0	8.0	18.5	4.5	2.820
SO 41121-6-3/8	018.1101.120	250	10x1.0	12	17	34.5	8.0	19.0	4.5	3.390
* SO 41121-6-1/2	018.1101.125	250	12x1.0	14	22	41.0	10.0	23.2	4.5	6.180
SO 41121-8-1/8	018.1101.160	150	12x1.0	14	12	30.5	5.0	17.5	6.0	2.260
SO 41121-8-1/4	018.1101.170	150	12x1.0	14	14	35.5	8.0	19.5	6.5	3.110
SO 41121-8-3/8	018.1101.180	150	12x1.0	14	17	36.0	8.0	20.0	6.5	3.730
SO 41121-8-1/2	018.1101.185	150	12x1.0	14	22	41.0	10.0	23.0	6.5	6.040
SO 41121-10-1/4	018.1101.270	125	14x1.0	17	14	37.5	8.0	19.5	8.5	3.630
SO 41121-10-3/8	018.1101.280	125	14x1.0	17	17	38.0	8.0	20.0	8.5	4.830
SO 41121-10-1/2	018.1101.285	125	14x1.0	17	22	43.0	10.0	23.0	8.5	8.550
SO 41121-12-1/4	018.1101.380	100	16x1.0	19	17	39.0	8.0	20.0	8.5	4.820
SO 41121-12-3/8	018.1101.390	100	16x1.0	19	17	39.0	8.0	20.0	10.0	5.110
SO 41121-12-1/2	018.1101.400	100	16x1.0	19	22	44.0	10.0	23.0	10.0	7.760
* SO 41121-12-3/4	018.1101.405	100	20x1.5	24	27	49.0	12.0	24.5	10.0	11.190
* SO 41121-13-1/4	018.1101.445	40	20x1.5	24	22	44.0	8.0	23.5	8.5	9.200
* SO 41121-13-3/8	018.1101.450	40	20x1.5	24	22	44.0	8.0	23.5	10.5	9.250
* SO 41121-13-1/2	018.1101.454	40	20x1.5	24	22	48.0	10.0	25.5	11.0	9.540
* SO 41121-13-3/4	018.1101.456	40	20x1.5	24	27	49.0	12.0	24.5	11.0	11.080
SO 41121-14-1/4	018.1101.500	40	20x1.5	24	22	44.0	8.0	23.5	8.5	9.100
SO 41121-14-3/8	018.1101.502	40	20x1.5	24	22	44.0	8.0	23.5	10.5	9.340
SO 41121-14-1/2	018.1101.504	40	20x1.5	24	22	48.0	10.0	25.5	12.0	9.430
SO 41121-14-3/4	018.1101.506	40	20x1.5	24	27	49.0	12.0	24.5	12.0	10.970
SO 41121-15-1/4	018.1101.528	40	20x1.5	24	22	44.0	8.0	23.5	8.5	8.900
SO 41121-15-3/8	018.1101.532	40	20x1.5	24	22	44.0	8.0	23.5	10.5	8.820
SO 41121-15-1/2	018.1101.534	40	20x1.5	24	22	48.0	10.0	25.5	13.0	9.110
SO 41121-15-3/4	018.1101.536	40	20x1.5	24	27	49.0	12.0	24.5	13.0	10.650

Fortsetzung nächste Seite

Suite à la prochaine page

Continued on next page

d=Rohrassen-ø
 e=kleinste Bohrung
 L=Mass in montiertem Zustand
 *=mit reduziertem Klemmring

d=ø extérieur du tube
 e=ø-min. de passage
 L=après montage
 *=avec bague de serrage de réduction

d=tube outside diameter
 e=minimum bore
 L=installed length
 *=with reduction compression ferrule

Gerade Einschraubverschraubung

Union mâle

Male adaptor union

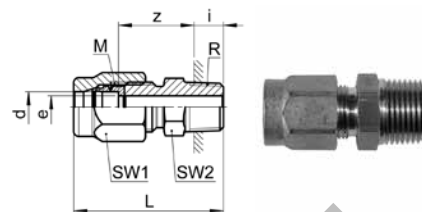

SO 41121

Type -d-R	Mat.-Nr.	bar	M	SW1	SW2	L	i	z	e	kg/100
Für metrische Rohre	Pour tubes métriques			For metric tubes						
R=Rohrgewinde (kegelig)	R=Filetage-gaz BSP (conique)			R=BSP thread (tapered)						
SO 41121-16-1/2	018.1101.566	40	24x1.5	27	24	50.5	10.0	26.5	14.0	11.280
SO 41121-16-3/4	018.1101.568	40	24x1.5	27	27	50.5	12.0	24.5	14.0	12.970
SO 41121-17-1/2	018.1101.596	40	24x1.5	27	24	50.5	10.0	26.5	15.0	11.030
SO 41121-17-3/4	018.1101.598	40	24x1.5	27	27	50.5	12.0	24.5	15.0	12.720
* SO 41121-17-1	018.1101.602	25	28x1.5	32	36	59.0	14.0	27.5	15.0	24.990
SO 41121-18-1/2	018.1101.646	40	24x1.5	27	24	50.5	10.0	26.5	15.0	10.760
SO 41121-18-3/4	018.1101.648	40	24x1.5	27	27	50.5	12.0	24.5	15.0	12.450
* SO 41121-18-1	018.1101.652	25	28x1.5	32	36	59.0	14.0	27.5	16.0	24.840
* SO 41121-19-3/4	018.1101.678	25	28x1.5	32	30	55.0	12.0	25.5	16.0	17.800
* SO 41121-19-1	018.1101.686	25	28x1.5	32	36	59.0	14.0	27.5	16.0	24.540
SO 41121-22-3/4	018.1101.768	25	28x1.5	32	30	55.0	12.0	25.5	19.0	16.440
SO 41121-22-1	018.1101.770	25	28x1.5	32	36	59.0	14.0	27.5	19.0	23.330
SO 41121-28-1	018.1101.850	16	36x2.0	41	36	64.5	14.0	31.0	24.0	31.300
SO 41121-35-1 1/4	018.1101.944	16	42x2.0	50	46	74.0	14.0	38.0	31.0	56.300
Für Zollrohre	Pour tubes pouces			For inch tubes						
SO 41121-3,2-1/8	018.1101.045	125	6x0.75	8	10	26.0	5.0	16.0	2.5	0.900
SO 41121-6,35-1/8	018.1101.135	250	10x1.0	12	10	28.5	5.0	16.0	4.5	1.680
SO 41121-6,35-1/4	018.1101.140	250	10x1.0	12	14	34.0	8.0	18.5	4.5	2.810
SO 41121-6,35-3/8	018.1101.145	250	10x1.0	12	17	34.5	8.0	19.0	4.5	3.350
SO 41121-9,52-1/4	018.1101.230	125	14x1.0	17	14	37.5	8.0	19.5	8.0	3.690
SO 41121-9,52-3/8	018.1101.235	125	14x1.0	17	17	38.0	8.0	20.0	8.0	1.890
* SO 41121-12,7-1/4	018.1101.430	40	20x1.5	24	22	44.0	8.0	23.5	8.5	9.200
* SO 41121-12,7-3/8	018.1101.432	40	20x1.5	24	22	44.0	8.0	23.5	10.5	9.250
* SO 41121-12,7-1/2	018.1101.434	40	20x1.5	24	22	48.0	10.0	25.5	11.0	9.540
* SO 41121-12,7-3/4	018.1101.436	40	20x1.5	24	27	49.0	12.0	24.5	11.0	11.080
SO 41121-15,88-1/2	018.1101.541	40	24x1.5	27	24	50.5	10.0	26.5	14.0	11.280
* SO 41121-19,05-3/4	018.1101.760	25	28x1.5	32	30	55.5	12.0	25.5	16.0	17.800
* SO 41121-22,22-1	018.1101.785	25	28x1.5	32	36	62.5	14.0	27.5	19.0	23.300

Umrechnung für "d" bei Zollrohren:

- 3,2 = 1/8
- 6,35 = 1/4
- 9,52 = 3/8
- 12,7 = 1/2
- 15,88 = 5/8
- 19,05 = 3/4
- 22,22 = 7/8

Conversion de "d" pour tubes en pouces:

- 3,2 = 1/8
- 6,35 = 1/4
- 9,52 = 3/8
- 12,7 = 1/2
- 15,88 = 5/8
- 19,05 = 3/4
- 22,22 = 7/8

Conversion for "d" for inch tubes:

- 3,2 = 1/8
- 6,35 = 1/4
- 9,52 = 3/8
- 12,7 = 1/2
- 15,88 = 5/8
- 19,05 = 3/4
- 22,22 = 7/8

d=Rohrassen-ø
e=kleinste Bohrung
L=Mass in montiertem Zustand
*=mit reduziertem Klemmring

d=ø extérieur du tube
e=ø-min. de passage
L=après montage
*=avec bague de serrage de réduction

d=tube outside diameter
e=minimum bore
L=installed length
*=with reduction compression ferrule

Gerade Einschraubverschraubung NPT
Union mâle NPT
Male adaptor union NPT

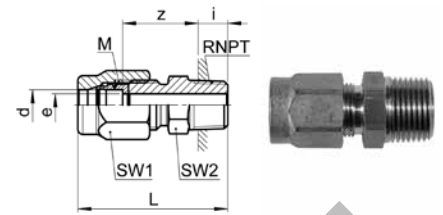

SO 41121 NPT

Type -d -RNPT	Mat.-Nr.	bar	M	SW1	SW2	L	i	z	e	kg/100
Für metrische Rohre RNPT=NPT Gewinde	Pour tubes métriques RNPT=Filetage NPT	For metric tubes RNPT=NPT thread								
* SO 41121-3-1/8 NPT	018.1102.040	125	8x1.0	10	12	29.0	7.0	17.0	2.5	1.710
SO 41121-4-1/8 NPT	018.1102.060	125	8x1.0	10	12	30.0	7.0	17.0	3.4	1.670
* SO 41121-4-1/4 NPT	018.1102.065	125	10x1.0	12	14	35.0	10.0	18.5	3.4	3.230
SO 41121-5-1/8 NPT	018.1102.082	125	8x1.0	10	12	30.5	7.0	17.0	3.4	1.650
* SO 41121-5-1/4 NPT	018.1102.084	125	10x1.0	12	14	36.0	10.0	18.5	4.0	3.180
SO 41121-6-1/8 NPT	018.1102.100	250	10x1.0	12	12	31.0	10.0	17.0	4.5	1.940
SO 41121-6-1/4 NPT	018.1102.110	250	10x1.0	12	14	36.5	10.0	18.5	4.5	3.120
* SO 41121-6-3/8 NPT	018.1102.120	250	12x1.0	14	22	38.0	10.0	20.0	4.5	5.540
* SO 41121-6-1/2 NPT	018.1102.125	250	12x1.0	14	22	44.0	14.0	22.5	4.5	6.200
SO 41121-8-1/4 NPT	018.1102.170	150	12x1.0	14	14	38.0	10.0	19.5	6.5	3.350
SO 41121-8-3/8 NPT	018.1102.180	150	12x1.0	14	17	38.0	10.0	20.0	6.5	5.540
SO 41121-8-1/2 NPT	018.1102.185	150	12x1.0	14	22	44.0	14.0	22.5	6.5	6.040
SO 41121-10-1/4 NPT	018.1102.270	125	14x1.0	17	14	40.0	10.0	19.5	8.5	3.860
SO 41121-10-3/8 NPT	018.1102.280	125	14x1.0	17	17	40.0	10.0	19.5	8.5	5.340
* SO 41121-10-1/2 NPT	018.1102.285	125	16x1.0	19	17	41.0	10.0	19.5	8.5	10.350
SO 41121-12-1/4 NPT	018.1102.380	100	16x1.0	19	17	41.0	10.0	20.5	8.5	4.980
SO 41121-12-3/8 NPT	018.1102.390	100	16x1.0	19	17	41.0	10.0	19.5	10.0	5.390
SO 41121-12-1/2 NPT	018.1102.400	100	16x1.0	19	22	41.0	14.0	19.5	10.0	10.350
* SO 41121-13-1/2 NPT	018.1102.454	40	20x1.5	24	22	47.0	14.0	25.0	11.0	10.240
SO 41121-14-1/2 NPT	018.1102.504	40	20x1.5	24	22	47.0	14.0	25.0	12.0	10.130
SO 41121-15-1/2 NPT	018.1102.534	40	20x1.5	24	22	47.0	14.0	25.0	13.0	9.810

Für Zollrohre	Pour tubes pouces	For inch tubes								
SO 41121-3,2-1/8 NPT	018.1102.045	100	8x1.0	10	12	29.5	7.0	17.0	2.5	1.710
SO 41121-6,35-1/8 NPT	018.1102.135	250	10x1.0	12	12	31.0	7.0	17.0	4.5	1.930
SO 41121-6,35-1/4 NPT	018.1102.140	250	10x1.0	12	14	36.0	10.0	18.5	4.5	3.110
SO 41121-9,52-1/4 NPT	018.1102.230	125	14x1.0	17	14	40.0	10.0	19.5	8.0	3.920
SO 41121-9,52-3/8 NPT	018.1102.235	125	14x1.0	17	17	40.0	10.0	19.5	8.0	5.340
* SO 41121-12,7-1/2 NPT	018.1102.434	40	20x1.5	24	22	47.0	14.0	25.0	11.0	10.240

Umrechnung für "d" bei Zollrohren:

- 3,2 = 1/8
- 6,35 = 1/4
- 9,52 = 3/8
- 12,7 = 1/2

Conversion de "d" pour tubes en pouces:

- 3,2 = 1/8
- 6,35 = 1/4
- 9,52 = 3/8
- 12,7 = 1/2

Conversion for "d" for inch tubes:

- 3,2 = 1/8
- 6,35 = 1/4
- 9,52 = 3/8
- 12,7 = 1/2

d=Rohrassen-ø
 e=kleinste Bohrung
 L=Mass in montiertem Zustand
 *=mit reduziertem Klemmring

d=ø extérieur du tube
 e=ø-min. de passage
 L=après montage
 *=avec bague de serrage de réduction

d=tube outside diameter
 e=minimum bore
 L=installed length
 *=with reduction compression ferrule

Gerade Einschraubverschraubung

mit Dichtkante

Union mâle

avec arête d'étanchéité

Male adaptor union

with edge seal

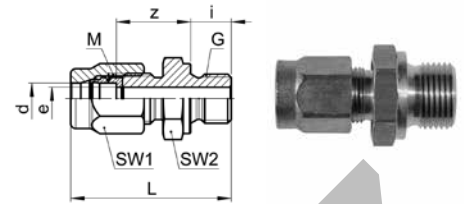

SO 41124

Type -d-G	Mat.-Nr.	bar	M	SW1	SW2	L	D	i	t	z	e	kg/100
Für metrische Rohre	Pour tubes métriques			For metric tubes								
G=Rohrgewinde (zylindrisch)	G=Filetage-gaz BSP (cylindrique)			G=BSP thread (parallel)								
SO 41124-2-1/8	018.1141.020	125	6x0.75	8	14	23.5	14.5	8.0	1.0	11.5	1.5	1.360
SO 41124-3-1/8	018.1141.040	125	6x0.75	8	14	25.0	14.5	8.0	1.0	12.0	2.5	1.400
SO 41124-4-1/8	018.1141.060	125	8x1.0	10	14	28.5	14.5	8.0	1.0	14.5	3.4	1.820
* SO 41124-4-1/4	018.1141.065	125	10x1.0	12	19	35.5	18.5	12.0	1.5	16.0	3.4	3.840
SO 41124-5-1/8	018.1141.082	125	8x1.0	10	14	29.0	14.5	8.0	1.0	14.5	3.5	1.790
* SO 41124-5-1/4	018.1141.084	125	10x1.0	12	19	35.5	18.5	12.0	1.5	16.0	4.0	3.790
SO 41124-6-1/8	018.1141.100	250	10x1.0	12	14	30.0	14.5	8.0	1.0	14.5	4.5	2.070
SO 41124-6-1/4	018.1141.110	250	10x1.0	12	19	35.5	18.5	12.0	1.5	16.0	4.5	3.730
* SO 41124-6-3/8	018.1141.120	250	12x1.0	14	22	38.5	22.5	12.0	2.0	18.5	6.5	5.880
* SO 41124-6-1/2	018.1141.125	250	12x1.0	14	27	42.0	26.5	14.0	2.5	20.0	4.5	6.900
SO 41124-8-1/8	018.1141.160	150	12x1.0	14	14	31.5	14.5	8.0	1.0	15.5	4.5	2.830
SO 41124-8-1/4	018.1141.170	150	12x1.0	14	19	37.0	18.5	12.0	1.5	17.0	6.5	3.860
SO 41124-8-3/8	018.1141.180	150	12x1.0	14	22	38.5	22.5	12.0	2.0	18.5	6.5	5.720
SO 41124-8-1/2	018.1141.185	150	12x1.0	14	27	42.0	27.0	14.0	2.5	20.0	6.5	9.457
SO 41124-10-1/4	018.1141.270	125	14x1.0	17	19	39.0	18.5	12.0	1.5	17.0	7.0	4.860
SO 41124-10-3/8	018.1141.280	125	14x1.0	17	22	40.5	22.5	12.0	2.0	18.5	8.5	6.250
* SO 41124-10-1/2	018.1141.285	125	16x1.0	19	27	45.0	27.0	14.0	2.5	20.0	8.5	7.500
SO 41124-12-1/4	018.1141.380	100	16x1.0	19	19	40.0	18.5	12.0	1.5	17.0	7.0	5.800
SO 41124-12-3/8	018.1141.390	100	16x1.0	19	22	41.5	22.5	12.0	2.0	18.5	10.0	6.500
SO 41124-12-1/2	018.1141.400	100	16x1.0	19	27	45.0	27.0	14.0	2.5	20.0	10.0	7.200
Für Zollrohre	Pour tubes pouces			For inch tubes								
SO 41124-3,2-1/8	018.1141.045	125	6x0.75	8	14	25.0	14.5	8.0	1.0	12.0	2.2	1.300
SO 41124-6,35-1/8	018.1141.135	250	10x1.0	12	14	30.0	14.5	8.0	1.0	14.5	4.5	2.006
SO 41124-6,35-1/4	018.1141.140	250	10x1.0	12	19	35.5	18.5	12.0	1.5	16.0	4.5	3.720
SO 41124-9,52-1/4	018.1141.230	125	14x1.0	17	19	39.0	18.5	12.0	1.5	17.0	8.0	4.920
SO 41124-9,52-3/8	018.1141.235	125	14x1.0	17	22	40.5	22.5	12.0	2.0	18.5	8.0	6.310

Umrechnung für "d" bei Zollrohren:

3,2 = 1/8
6,35 = 1/4
9,52 = 3/8

Conversion de "d" pour tubes en pouces:

3,2 = 1/8
6,35 = 1/4
9,52 = 3/8

Conversion for "d" for inch tubes:

3,2 = 1/8
6,35 = 1/4
9,52 = 3/8

Einbauempfehlung:

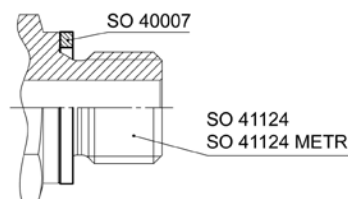

Bei Bedarf ist die entsprechende Dichtung SO 40007 / SO 40507 separat zu bestellen.

Conseil de montage:

Si nécessaire, le joint correspondant SO 40007 / SO 40507 doit être commandé séparément.

Recommendation for installation:

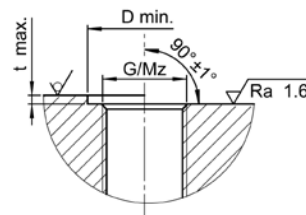

If necessary, the relevant washer SO 40007 / SO 40507 must be ordered separately.

d=Rohrassen-ø
e=kleinste Bohrung
L=Mass in montiertem Zustand
*=mit reduziertem Klemmring

d=ø extérieur du tube
e=ø-min. de passage
L=après montage
*=avec bague de serrage de réduction

d=tube outside diameter
e=minimum bore
L=installed length
*=with reduction compression ferrule

Gerade Einschraubverschraubung METR

mit Dichtkante

Union mâle METR

avec arête d'étanchéité

Male adaptor union METR

with edge seal

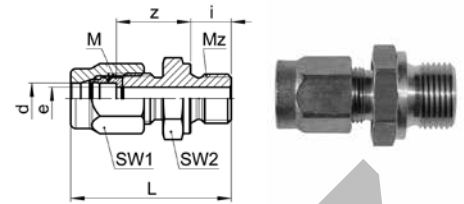

SO 41124 METR

Type - d - Mz	Mat.-Nr.	bar	M	SW1	SW2	L	D	i	t	z	e	kg/100
Für metrische Rohre	Pour tubes métriques					For metric tubes						
Mz=metrisches Gewinde (zylindrisch)	Mz=Filetage métrique (cylindrique)					Mz=Metric thread (parallel)						
SO 41124-2-M5 *	018.1143.020	125	6x0.75	8	8	18.0	10.0	4.5	0.5	9.5	1.5	0.500
SO 41124-3-M5 *	018.1143.050	125	6x0.75	8	8	20.0	10.0	4.5	0.5	10.0	2.2	0.540
* SO 41124-3-M6x0,75 *	018.1143.055	125	8x1.0	10	8	26.0	10.0	6.0	0.5	13.0	2.5	1.110
* SO 41124-3-M8x1	018.1143.060	125	8x1.0	10	12	29.5	12.5	8.0	1.0	14.0	2.5	1.570
SO 41124-4-M5 *	018.1143.080	125	8x1.0	10	8	24.0	10.0	4.5	0.5	13.0	2.2	1.000
SO 41124-4-M6x0,75 *	018.1143.085	125	8x1.0	10	8	25.5	10.0	6.0	0.5	13.0	2.5	1.070
SO 41124-4-M6x1 *	018.1143.086	125	8x1.0	10	10	24.5	12.0	5.0	0.5	13.0	2.5	1.050
SO 41124-4-M8x1	018.1143.090	125	8x1.0	10	12	29.0	12.5	8.0	1.0	15.0	3.4	1.530
* SO 41124-4-M10x1	018.1143.096	125	10x1.0	12	14	30.5	14.5	8.0	1.0	14.5	3.4	1.490
SO 41124-5-M5 *	018.1143.110	125	8x1.0	10	8	24.5	10.0	4.5	0.5	13.0	2.2	0.990
SO 41124-5-M6x0,75 *	018.1143.115	125	8x1.0	10	8	26.0	10.0	6.0	0.5	13.0	2.5	1.050
SO 41124-5-M6 *	018.1143.118	125	8x1.0	10	10	25.0	12.0	5.0	0.5	13.0	2.5	1.030
SO 41124-5-M8x1	018.1143.125	125	8x1.0	10	12	29.5	12.5	8.0	1.0	14.5	3.5	1.510
* SO 41124-5-M10x1	018.1143.135	125	10x1.0	12	14	33.5	14.5	8.0	1.0	14.5	4.0	1.440
SO 41124-6-M5 *	018.1143.155	250	10x1.0	12	10	25.5	12.0	4.5	0.5	13.0	2.2	1.560
SO 41124-6-M8x1	018.1143.170	250	10x1.0	12	12	30.5	12.5	8.0	1.0	14.5	3.5	1.450
SO 41124-6-M10x1	018.1143.180	250	10x1.0	12	14	30.5	14.5	8.0	1.0	14.5	4.5	2.193
* SO 41124-6-M12x1,5	018.1143.195	250	12x1.0	14	17	37.5	17.5	12.0	1.5	17.0	4.5	3.760
SO 41124-8-M12x1,5	018.1143.240	150	12x1.0	14	17	37.5	17.5	12.0	1.5	17.0	6.0	3.600
* SO 41124-8-M14x1,5	018.1143.245	150	14x1.0	17	19	40.0	19.5	12.0	1.5	17.0	6.5	5.120
SO 41124-10-M12x1,5	018.1143.275	125	14x1.0	17	17	40.5	17.5	12.0	1.5	17.0	6.0	4.940
SO 41124-10-M14x1,5	018.1143.280	125	14x1.0	17	19	40.5	19.5	12.0	1.5	17.0	7.5	4.920
* SO 41124-10-M16x1,5	018.1143.285	125	16x1.0	19	22	43.5	21.5	12.0	1.5	19.0	8.5	5.780
SO 41124-12-M16x1,5	018.1143.330	100	16x1.0	19	22	44.0	21.5	12.0	1.5	19.0	9.0	5.500
* SO 41124-12-M18x1,5	018.1143.333	100	20x1.5	24	24	48.0	23.5	12.0	2.0	23.0	10.0	10.820
SO 41124-12-M22x1,5	018.1143.338	100	16x1.0	19	27	47.0	28.0	14.0	2.5	20.0	10.0	12.350
* SO 41124-13-M18x1,5	018.1143.365	40	20x1.5	24	24	48.0	23.5	12.0	2.0	23.0	11.0	10.710
* SO 41124-13-M22x1,5	018.1143.369	40	20x1.5	24	27	50.0	28.0	14.0	2.5	22.5	11.0	12.100
SO 41124-14-M18x1,5	018.1143.380	40	20x1.5	24	24	48.0	23.5	12.0	2.0	23.0	11.0	10.600
SO 41124-14-M22x1,5	018.1143.385	40	20x1.5	24	27	49.5	28.0	14.0	2.5	22.5	12.0	12.000
SO 41124-15-M18x1,5	018.1143.390	40	20x1.5	24	24	48.0	23.5	12.0	2.0	23.0	11.0	10.280
SO 41124-15-M22x1,5	018.1143.395	40	20x1.5	24	27	50.0	28.0	14.0	2.5	25.0	13.0	11.680

* Für die Größen M5, M6, M6x0.75, M6x1 empfiehlt sich die Verwendung der Dichtung SO 40007 oder SO 40507.
Bei Bedarf ist die entsprechende Dichtung SO 40007 / SO 40507 separat zu bestellen.

* Pour les dimensions M5, M6, M6x0.75, M6x1 nous recommandons l'utilisation du joint SO 40007 ou SO 40507.
Si nécessaire, le joint correspondant SO 40007 / SO 40507 doit être commandé séparément.

* For sizes M5, M6, M6x0.75, M6x1 we recommend the use of the washer SO 40007 or SO 40507.
If necessary, the relevant washer SO 40007 / SO 40507 must be ordered separately.

Fortsetzung nächste Seite

Suite à la prochaine page

Continued on next page

d=Rohrassen-ø
e=kleinste Bohrung
L=Mass in montiertem Zustand
*=mit reduziertem Klemmring

d=ø extérieur du tube
e=ø-min. de passage
L=après montage
*=avec bague de serrage de réduction

d=tube outside diameter
e=minimum bore
L=installed length
*=with reduction compression ferrule

Gerade Einschraubverschraubung METR

mit Dichtkante

Union mâle METR

avec arête d'étanchéité

Male adaptor union METR

with edge seal

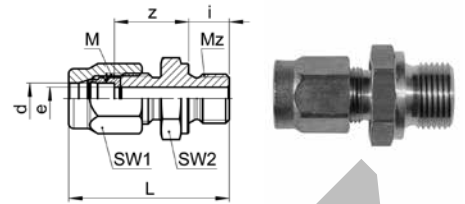

SO 41124 METR

Type -d -Mz		bar	M	SW1	SW2	L	D	i	t	z	e	kg/100	
Für Zollrohre		Pour tubes pouces					For inch tubes						
Mz=metrisches Gewinde (zylindrisch)		Mz=Filetage métrique (cylindrique)					Mz=Metric thread (parallel)						
SO 41124-3,2-M5 *	018.1143.067	125	6x0.75	8	8	20.0	10.0	4.5	0.5	10.0	2.2	0.500	
SO 41124-6,35-M5 *	018.1143.205	250	10x1.0	12	10	25.5	12.0	4.5	0.5	13.0	2.2	1.550	
SO 41124-6,35-M8x1	018.1143.207	250	10x1.0	12	12	30.5	12.5	8.0	1.0	14.5	3.5	1.450	
SO 41124-6,35-M10x1	018.1143.210	250	10x1.0	12	14	30.5	14.5	8.0	1.0	14.5	4.5	2.090	
SO 41124-9,52-M12x1,5	018.1143.261	125	14x1.0	17	17	40.0	17.5	12.0	1.5	17.0	6.0	5.000	
SO 41124-9,52-M14x1,5	018.1143.265	125	14x1.0	17	19	40.0	19.5	12.0	1.5	17.0	7.5	4.980	
★ SO 41124-12,7-M18x1,5	018.1143.354	40	20x1.5	24	24	48.0	23.5	12.0	2.0	22.5	11.0	10.710	
★ SO 41124-12,7-M22x1,5	018.1143.358	40	20x1.5	24	27	50.0	28.0	14.0	2.5	22.5	11.0	12.100	

Umrechnung für "d" bei Zollrohren:

- 3,2 = 1/8
- 6,35 = 1/4
- 9,52 = 3/8
- 12,7 = 1/2

Conversion de "d" pour tubes en pouces:

- 3,2 = 1/8
- 6,35 = 1/4
- 9,52 = 3/8
- 12,7 = 1/2

Conversion for "d" for inch tubes:

- 3,2 = 1/8
- 6,35 = 1/4
- 9,52 = 3/8
- 12,7 = 1/2

Anwendungsbeispiele:

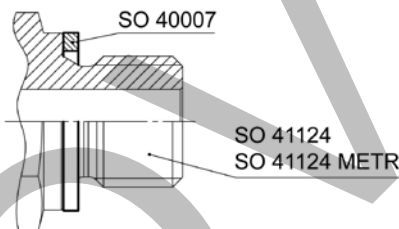

* Für die Größen M5, M6, M6x0.75, M6x1 empfiehlt sich die Verwendung der Dichtung SO 40007 oder SO 40507. Bei Bedarf ist die entsprechende Dichtung SO 40007 / SO 40507 separat zu bestellen.

Exemples d'utilisation:

* Pour les dimensions M5, M6, M6x0.75, M6x1 nous recommandons l'utilisation du joint SO 40007 ou SO 40507. Si nécessaire, le joint correspondant SO 40007 / SO 40507 doit être commandé séparément.

Sample combinations:

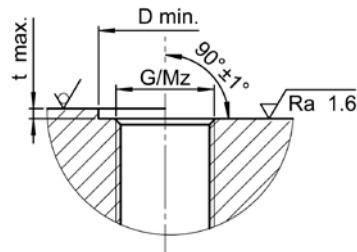

* For sizes M5, M6, M6x0.75, M6x1 we recommend the use of the washer SO 40007 or SO 40507. If necessary, the relevant washer SO 40007 / SO 40507 must be ordered separately.

Gerade Einschraubverschraubung

mit Conovor O-Ringabdichtung (NBR)

Union mâle

avec joint torique système Conovor (NBR)

Male adaptor union

with Conovor O-ring seal (NBR)

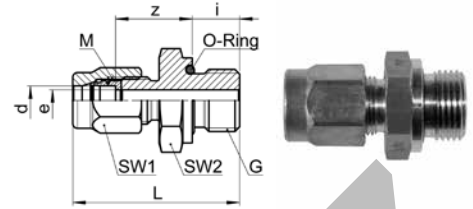

SO 41124 OR

Type -d-G	Mat.-Nr.	bar	M	SW1	SW2	L	D	i	t	O-Ring	z	e	kg/100
Für metrische Rohre	Pour tubes métriques			For metric tubes									
G=Rohrgewinde (zylindrisch)	G=Filetage-gaz BSP (cylindrique)			G=BSP thread (parallel)									
* SO 41124-4-1/8 OR	018.1171.060	100	10x1.0	12	14	30.0	14.5	8.0	1.0	8.73x1.78	14.5	3.4	2.300
* SO 41124-4-1/4 OR	018.1171.065	100	10x1.0	12	19	33.5	18.5	10.0	1.5	11.1x1.78	16.0	3.4	3.900
* SO 41124-5-1/8 OR	018.1171.082	100	10x1.0	12	14	30.0	14.5	8.0	1.0	8.73x1.78	14.5	4.0	2.200
* SO 41124-5-1/4 OR	018.1171.084	100	10x1.0	12	19	33.5	18.5	10.0	1.5	11.1x1.78	16.0	4.0	3.900
SO 41124-6-1/8 OR	018.1171.100	250	10x1.0	12	14	30.0	14.5	8.0	1.0	8.73x1.78	14.5	4.5	2.000
SO 41124-6-1/4 OR	018.1171.110	250	10x1.0	12	19	33.5	18.5	10.0	1.5	11.1x1.78	16.0	4.5	3.900
SO 41124-6-3/8 OR	018.1171.120	250	10x1.0	12	22	36.5	22.5	10.0	2.0	14.0x1.78	19.0	4.0	4.970
SO 41124-8-1/8 OR	018.1171.160	150	12x1.0	14	14	32.0	14.5	8.0	1.0	8.73x1.78	15.5	5.0	2.800
SO 41124-8-1/4 OR	018.1171.170	150	12x1.0	14	19	35.0	18.5	10.0	1.5	11.1x1.78	17.0	6.5	4.000
* SO 41124-8-3/8 OR	018.1171.180	150	14x1.0	17	22	38.5	22.5	10.0	2.0	14.0x1.78	18.5	6.5	6.400
SO 41124-10-1/4 OR	018.1171.270	125	14x1.0	17	19	37.0	18.5	10.0	1.5	11.1x1.78	17.0	6.5	4.700
SO 41124-10-3/8 OR	018.1171.280	125	14x1.0	17	22	38.5	22.5	10.0	2.0	14.0x1.78	18.5	8.5	6.200
* SO 41124-10-1/2 OR	018.1171.285	125	16x1.0	17	27	42.0	27.0	12.0	2.5	18.72x2.62	19.0	8.5	7.900
SO 41124-12-3/8 OR	018.1171.390	100	16x1.0	19	22	39.5	22.5	10.0	2.0	14.0x1.78	18.5	10.0	6.300
SO 41124-12-1/2 OR	018.1171.400	100	16x1.0	19	27	42.0	27.0	12.0	2.5	18.72x2.62	19.0	10.0	7.700
* SO 41124-13-1/2 OR	018.1171.454	40	20x1.5	24	27	46.0	27.0	12.0	2.5	18.72x2.62	21.5	14.0	13.600
SO 41124-14-3/8 OR	018.1171.502	40	20x1.5	24	22	43.5	22.5	10.0	2.0	14.0x1.78	20.0	10.5	11.000
SO 41124-14-1/2 OR	018.1171.504	40	20x1.5	24	27	46.0	27.0	12.0	2.5	18.72x2.62	21.5	12.0	13.500
SO 41124-15-3/8 OR	018.1171.532	40	20x1.5	24	22	43.5	22.5	10.0	2.0	14.0x1.78	20.0	10.5	11.000
SO 41124-15-1/2 OR	018.1171.534	40	20x1.5	24	27	46.0	27.0	12.0	2.5	18.72x2.62	21.5	13.0	13.500
SO 41124-16-1/2 OR	018.1171.566	40	24x1.5	27	27	47.5	27.0	12.0	2.5	18.72x2.62	21.5	13.0	16.100
SO 41124-17-1/2 OR	018.1171.596	40	24x1.5	27	27	47.5	27.0	12.0	2.5	18.72x2.62	21.5	13.0	15.500
* SO 41124-17-3/4 OR	018.1171.598	40	28x1.5	32	32	52.0	33.0	12.0	2.5	23.47x2.62	22.5	15.0	23.800
SO 41124-18-1/2 OR	018.1171.646	40	24x1.5	27	27	47.5	27.0	12.0	2.5	18.72x2.62	21.5	13.0	15.300
* SO 41124-18-3/4 OR	018.1171.648	25	28x1.5	32	32	52.0	33.0	12.0	2.5	23.47x2.62	22.5	16.0	23.600
* SO 41124-19-3/4 OR	018.1171.678	25	28x1.5	32	32	52.0	33.0	12.0	2.5	23.47x2.62	22.5	16.0	23.500
SO 41124-22-3/4 OR	018.1171.768	25	28x1.5	32	32	52.0	33.0	12.0	2.5	23.47x2.62	22.5	19.0	22.100

Für Zollrohre

Pour tubes pouces

For inch tubes

SO 41124-6,35-1/8 OR	018.1171.135	250	10x1.0	12	14	30.0	14.5	8.0	1.0	8.73x1.78	14.5	4.5	2.100
SO 41124-6,35-1/4 OR	018.1171.140	250	10x1.0	12	19	33.5	18.5	10.0	1.5	11.1x1.78	16.0	4.5	3.800
SO 41124-9,52-1/4 OR	018.1171.230	125	14x1.0	17	19	37.0	18.5	10.0	1.5	11.1x1.78	17.0	6.5	4.800
SO 41124-9,52-3/8 OR	018.1171.235	125	14x1.0	17	22	38.5	22.5	10.0	2.0	14.0x1.78	18.5	8.0	6.100
SO 41124-12,7-1/2 OR	018.1171.434	40	20x1.5	24	27	46.0	27.0	12.0	2.5	18.72x2.62	21.5	11.0	13.800
SO 41124-15,88-1/2 OR	018.1171.541	40	24x1.5	27	27	47.5	27.0	12.0	2.5	18.72x2.62	21.5	13.0	16.100

Umrechnung für "d" bei Zollrohren:

6,35 = 1/4
9,52 = 3/8
12,7 = 1/2
15,88 = 5/8

Conversion de "d" pour tubes en pouces:

6,35 = 1/4
9,52 = 3/8
12,7 = 1/2
15,88 = 5/8

Conversion for "d" for inch tubes:

6,35 = 1/4
9,52 = 3/8
12,7 = 1/2
15,88 = 5/8

Fortsetzung nächste Seite

Suite à la prochaine page

Continued on next page

d=Rohrassens-ø
e=kleinste Bohrung
L=Mass in montiertem Zustand
*=mit reduziertem Klemmring

d=ø extérieur du tube
e=ø-min. de passage
L=après montage
*=avec bague de serrage de réduction

d=tube outside diameter
e=minimum bore
L=installed length
*=with reduction compression ferrule

Gerade Einschraubverschraubung METR

mit Conovor O-Ringabdichtung (NBR)

Union mâle METR

avec joint torique système Conovor (NBR)

Male adaptor union METR

with Conovor O-ring seal (NBR)

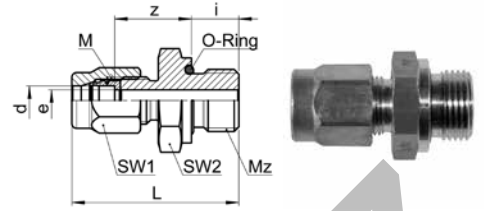

SO 41124 OR METR

Type -d-Mz	Mat.-Nr.	bar	M	SW1	SW2	L	D	i	t	O-Ring	z	e	kg/100
Mz=metrisches Gewinde (zylindrisch)	Mz=Filetage métrique (cylindrique)	Mz=Metric thread (parallel)											
SO 41124-4-M5 OR	018.1173.080	100	8x1.0	10	8	25.5	8.5	5.0	0.5	4.0x1.5	14.0	2.2	1.000
SO 41124-5-M5 OR	018.1173.110	100	8x1.0	10	8	26.0	8.5	5.0	0.5	4.0x1.5	14.0	2.2	0.900

Einbauempfehlung:

Conseil de montage:

Recommendation for installation:

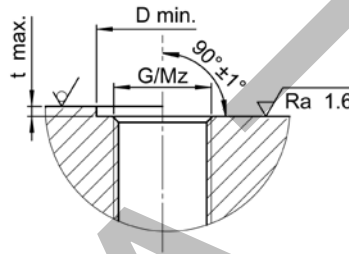

Einsatztemperaturbereich: -30 °C bis +100 °C

Die Vorteile dieser O-Ringabdichtung:

- keine Dichtmittelreste in Geräten
- einwandfreie Abdichtung
- keine Beschädigung von Geräten durch konische Gewinde
- schnelle Montage

Conovor patentierte O-Ring Abdichtung

Plage de température de service: -30 °C à +100 °C

Les avantages de cette étanchéité à joint torique:

- aucun reste de scellant dans les équipements
- une étanchéité parfaite
- aucun endommagement de l'équipement par le filetage conique
- facilité d'installation

Etanchéité à joint torique brevetée Conovor

Operating temperature range: -30 °C to +100 °C

Advantages of this O-ring seal:

- no sealing residues in devices
- perfect seal
- no damage to devices due to tapered thread
- rapid assembly

Conovor patented O-ring seal

d=Rohrassen-ø
e=kleinste Bohrung
L=Mass in montiertem Zustand
*=mit reduziertem Klemmring

d=ø extérieur du tube
e=ø-min. de passage
L=après montage
*=avec bague de serrage de réduction

d=tube outside diameter
e=minimum bore
L=installed length
*=with reduction compression ferrule

Gerade Aufschraubverschraubung
Union femelle
Female adaptor union

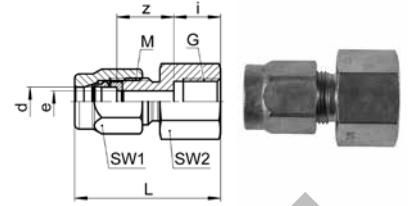

SO 41221

Type -d -G	Mat.-Nr.	bar	M	SW1	SW2	L	i	z	e	kg/100
Für metrische Rohre	Pour tubes métriques		For metric tubes							
G=Rohrgewinde (zylindrisch)	G=Filetage-gaz BSP (cylindrique)		G=BSP thread (parallel)							
* SO 41221-3-1/8	018.1201.040	125	8x1.0	10	14	28.5	10.0	12.0	2.5	2.060
SO 41221-4-1/8	018.1201.060	125	8x1.0	10	14	28.0	10.0	12.0	3.4	2.000
* SO 41221-4-1/4	018.1201.065	125	10x1.0	12	17	31.5	11.0	13.0	3.4	3.110
SO 41221-5-1/8	018.1201.082	125	8x1.0	10	14	28.5	10.0	12.0	3.5	2.000
* SO 41221-5-1/4	018.1201.084	125	10x1.0	12	17	31.5	11.0	13.0	4.0	3.060
SO 41221-6-1/8	018.1201.100	250	10x1.0	12	14	29.5	10.0	12.0	4.5	2.360
SO 41221-6-1/4	018.1201.110	250	10x1.0	12	17	31.5	11.0	13.0	4.5	3.000
* SO 41221-6-3/8	018.1201.120	250	12x1.0	14	22	34.0	12.0	14.0	4.5	5.100
* SO 41221-6-1/2	018.1201.125	250	12x1.0	14	27	36.0	14.0	14.0	4.5	7.400
SO 41221-8-1/8	018.1201.160	150	12x1.0	14	14	31.0	10.0	13.0	6.5	2.790
SO 41221-8-1/4	018.1201.170	150	12x1.0	14	17	33.0	11.0	14.0	6.5	2.430
SO 41221-8-3/8	018.1201.180	150	12x1.0	14	22	34.0	12.0	14.0	6.5	4.940
SO 41221-8-1/2	018.1201.185	150	12x1.0	14	27	36.0	14.0	14.0	6.5	7.300
SO 41221-10-1/4	018.1201.270	125	14x1.0	17	17	35.0	11.0	14.0	8.5	4.180
SO 41221-10-3/8	018.1201.280	125	14x1.0	17	22	36.0	12.0	14.0	8.5	5.900
* SO 41221-10-1/2	018.1201.285	100	16x1.0	19	27	39.0	14.0	14.0	8.5	9.060
SO 41221-12-1/4	018.1201.380	100	16x1.0	19	17	36.0	11.0	14.0	8.5	4.790
SO 41221-12-3/8	018.1201.390	100	16x1.0	19	22	37.0	12.0	14.0	10.5	6.450
SO 41221-12-1/2	018.1201.400	100	16x1.0	19	27	39.0	14.0	14.0	10.0	8.780
* SO 41221-12-3/4	018.1201.405	40	20x1.5	24	32	45.5	17.0	16.0	10.0	14.180
* SO 41221-13-1/2	018.1201.454	40	20x1.5	24	27	45.0	14.0	18.5	11.0	11.950
* SO 41221-13-3/4	018.1201.456	40	20x1.5	24	32	45.5	17.0	16.0	11.0	14.070
SO 41221-14-1/2	018.1201.504	40	20x1.5	24	27	45.0	14.0	18.5	12.0	11.840
SO 41221-14-3/4	018.1201.506	40	20x1.5	24	32	45.5	17.0	16.0	12.0	13.960
SO 41221-15-1/2	018.1201.534	40	20x1.5	24	27	45.0	14.0	18.5	12.5	11.520
SO 41221-15-3/4	018.1201.536	40	20x1.5	24	32	45.5	17.0	16.0	12.0	13.640
SO 41221-16-1/2	018.1201.566	40	24x1.5	27	27	45.0	10.0	17.0	14.0	13.270
SO 41221-16-3/4	018.1201.568	40	24x1.5	27	32	47.0	17.0	16.0	14.0	15.700
SO 41221-17-1/2	018.1201.596	40	24x1.5	27	27	45.0	14.0	17.0	14.5	13.020
SO 41221-17-3/4	018.1201.598	40	24x1.5	27	32	47.0	17.0	16.0	15.0	15.450
SO 41221-18-1/2	018.1201.646	40	24x1.5	27	27	45.0	14.0	17.0	14.5	12.750
SO 41221-18-3/4	018.1201.648	40	24x1.5	27	32	47.0	17.0	16.0	15.0	15.180
* SO 41221-19-3/4	018.1201.678	25	28x1.5	32	32	51.5	17.0	17.0	16.0	20.100
SO 41221-22-3/4	018.1201.768	25	28x1.5	32	32	51.5	17.0	17.0	19.0	18.710
SO 41221-28-1	018.1201.850	16	36x2.0	41	41	60.5	20.0	21.0	24.0	38.000

Fortsetzung nächste Seite

Suite à la prochaine page

Continued on next page

d=Rohrassen-ø
 e=kleinste Bohrung
 L=Mass in montiertem Zustand
 *=mit reduziertem Klemmring

d=ø extérieur du tube
 e=ø-min. de passage
 L=après montage
 *=avec bague de serrage de réduction

d=tube outside diameter
 e=minimum bore
 L=installed length
 *=with reduction compression ferrule

Gerade Aufschraubverschraubung Union femelle Female adaptor union

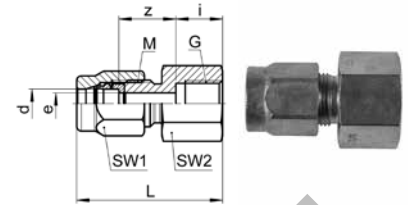

SO 41221

Type -d -G	Mat.-Nr.	bar	M	SW1	SW2	L	i	z	e	kg/100
Für Zollrohre	Pour tubes pouces		For inch tubes							
G=Rohrgewinde (zylindrisch)	G=Filetage-gaz BSP (cylindrique)		G=BSP thread (parallel)							
SO 41221-6,35-1/8	018.1201.135	250	10x1.0	12	14	29.5	10.0	12.0	4.5	2.350
SO 41221-6,35-1/4	018.1201.140	250	10x1.0	12	17	31.5	11.0	13.0	4.5	2.990
SO 41221-9,52-1/4	018.1201.230	125	14x1.0	17	17	35.0	11.0	14.0	8.0	4.240
SO 41221-9,52-3/8	018.1201.235	125	14x1.0	17	22	36.0	12.0	14.0	8.0	4.860
★ SO 41221-12,7-1/2	018.1201.434	40	20x1.5	24	27	45.0	14.0	18.5	11.0	11.950
★ SO 41221-12,7-3/4	018.1201.436	40	20x1.5	24	32	45.5	17.0	16.0	11.0	14.070

Umrechnung für "d" bei Zollrohren:

6,35 = 1/4
9,52 = 3/8
12,7 = 1/2

Conversion de "d" pour tubes en pouces:

6,35 = 1/4
9,52 = 3/8
12,7 = 1/2

Conversion for "d" for inch tubes:

6,35 = 1/4
9,52 = 3/8
12,7 = 1/2

Gerade Aufschraubverschraubung NPT Union femelle NPT Female adaptor union NPT

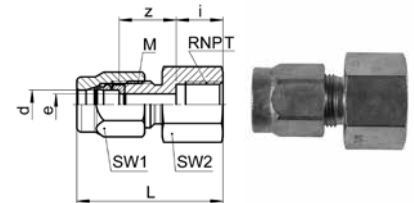

SO 41221 NPT

Type -d -RNPT	Mat.-Nr.	bar	M	SW1	SW2	L	i	z	e	kg/100
Für metrische Rohre	Pour tubes métriques		For metric tubes							
RNPT=NPT Gewinde	RNPT=Filetage NPT		RNPT=NPT thread							
SO 41221-6-1/8 NPT	018.1202.100	250	10x1.0	12	14	29.5	10.0	12.0	4.5	2.360
SO 41221-6-1/4 NPT	018.1202.110	250	10x1.0	12	17	34.0	14.0	12.5	4.5	2.650
★ SO 41221-6-3/8 NPT	018.1202.120	250	12x1.0	14	22	36.0	14.0	14.0	4.5	5.100
★ SO 41221-8-1/4 NPT	018.1202.170	150	14x1.0	17	17	37.0	14.0	13.0	6.5	3.000
SO 41221-8-3/8 NPT	018.1202.180	150	12x1.0	14	22	36.0	14.0	14.0	6.5	5.100
SO 41221-8-1/2 NPT	018.1202.185	150	12x1.0	14	27	40.5	18.0	14.5	6.5	5.900
SO 41221-10-1/4 NPT	018.1202.270	125	14x1.0	17	17	37.0	14.0	13.0	8.5	4.180
★ SO 41221-10-3/8 NPT	018.1202.280	100	16x1.0	19	22	38.0	14.0	14.0	8.5	7.300
★ SO 41221-10-1/2 NPT	018.1202.285	100	16x1.0	19	27	43.5	18.0	14.5	8.5	9.000
SO 41221-12-3/8 NPT	018.1202.390	100	16x1.0	19	22	39.0	14.0	14.0	10.0	8.900
SO 41221-12-1/2 NPT	018.1202.400	100	16x1.0	19	27	43.5	18.0	14.5	10.0	9.000

Für Zollrohre

Pour tubes pouces

For inch tubes

SO 41221-6,35-1/8 NPT	018.1202.135	250	10x1.0	12	14	29.5	10.0	12.0	4.5	2.350
SO 41221-6,35-1/4 NPT	018.1202.140	250	10x1.0	12	17	34.0	14.0	12.5	4.5	2.640
SO 41221-9,52-1/4 NPT	018.1202.230	125	14x1.0	17	17	37.0	14.0	13.0	8.5	4.240

Umrechnung für "d" bei Zollrohren:

6,35 = 1/4
9,52 = 3/8

Conversion de "d" pour tubes en pouces:

6,35 = 1/4
9,52 = 3/8

Conversion for "d" for inch tubes:

6,35 = 1/4
9,52 = 3/8

d=Rohrassens-ø
e=kleinste Bohrung
L=Mass in montiertem Zustand
*=mit reduziertem Klemmring

d=ø extérieur du tube
e=ø-min. de passage
L=après montage
*=avec bague de serrage de réduction

d=tube outside diameter
e=minimum bore
L=installed length
*=with reduction compression ferrule

Verbindungsrippel
Pièce folle
Tube stub

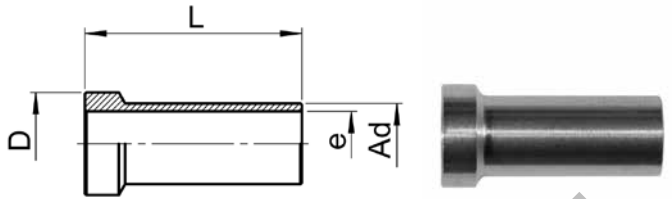

SO 41300

Type -Ad	Mat.-Nr.	bar	L	D	e	kg/100
SO 41300-A6	016.1300.060	200	19.0	8.4	4.0	0.350
SO 41300-A8	016.1300.080	100	22.0	10.5	6.0	0.520
SO 41300-A10	016.1300.100	80	27.0	12.7	8.0	0.850
SO 41300-A12	016.1300.120	60	30.0	14.7	9.0	1.400
SO 41300-A14	016.1300.140	40	31.0	17.5	11.0	2.000
SO 41300-A15	016.1300.150	40	31.0	18.0	12.0	2.100
SO 41300-A17	016.1300.170	40	37.0	21.0	14.0	2.900
SO 41300-A18	016.1300.180	40	36.0	22.0	15.0	3.200
SO 41300-A22	016.1300.220	25	40.0	26.0	19.0	4.100
SO 41300-A28	016.1300.280	16	47.0	32.5	23.0	9.800

Anwendungsbeispiele:

Exemples d'utilisation:

Sample combinations:

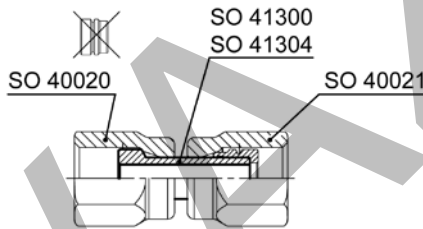

Werden die Verbindungsrippel mit einer Anschlussmutter und einem Armaturenanschluss (Anschlussmutter und Klemmring) verbunden, ergibt dies eine einstellbare Verschraubung.

Si l'insert de la pièce folle est relié à un écrou et à un écrou de raccordement (écrou et bague de serrage), cela fournit une union orientable.

If the tube stubs are coupled with a union nut and a nut connection (union nut and compression ferrule), an adjustable union is produced.

Auch vormontiert erhältlich (SO 41325 / SO 41326).

Aussi disponible pré-assemblé (SO 41325 / SO 41326).

Also available pre-assembled (SO 41325 / SO 41326).

Montagehinweis: Auf Seite des angedrehten Klemmringes (links im Bild) Anschlussmutter mit 1/4 Umdrehung anziehen. Auf Seite des Armaturenanschlusses (rechts im Bild) Anschlussmutter mit 1 3/4 Umdrehung anziehen.

Note d'installation: Serrez l'écrou sur le côté de la bague de serrage tournée (à gauche sur l'illustr.) de 1/4 de tour. Serrez l'écrou de l'autre côté (à droite sur l'illustr.) de 1 3/4 tour.

Assembly information: Tighten the union nut on the side of the turned compression ferrule (left in pict.) with 1/4 turn. Tighten the union nut on the other side (right in pict.) 1 3/4 turns.

Anwendungsbeispiele:

Exemples d'utilisation:

Sample combinations:

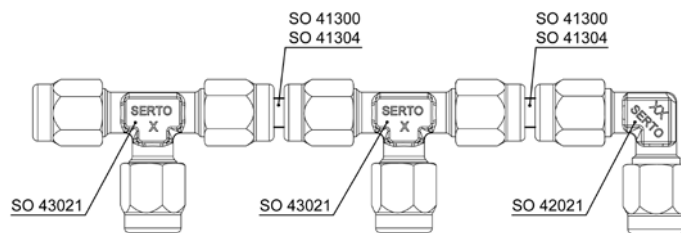

Mit der einstellbaren Verschraubung lassen sich Formteile mit dem gleichen Anschlussgewinde verbinden.

Avec l'union orientable, il est possible de connecter des raccords de même filetages.

With the adjustable union, parts with the same connecting thread can be connected.

Hinweis: Nur mit Verbindungsrippel SO 41304 ist eine radiale Demontage möglich.

Remarque: Un démontage radial n'est possible qu'avec la pièce folle SO 41304.

Note: Radial dismantling is only possible with tube stub SO 41304.

Verbindungsrippel

radial demontierbar

Pièce folle

démontable radialement

Tube stub

radial dismantling

SO 41304

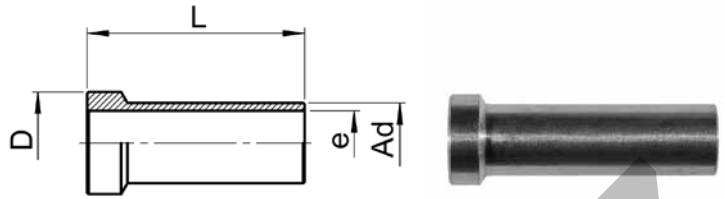

Type -Ad	Mat.-Nr.	bar	L	D	e	kg/100
SO 41304-A6	016.1310.060	200	29.0	8.4	4.0	0.470
SO 41304-A8	016.1310.080	100	32.0	10.5	6.0	0.700
SO 41304-A10	016.1310.100	80	37.0	12.7	8.0	1.040
SO 41304-A12	016.1310.120	60	39.0	14.7	9.0	1.800

Anwendungsbeispiele:

Exemples d'utilisation:

Sample combinations:

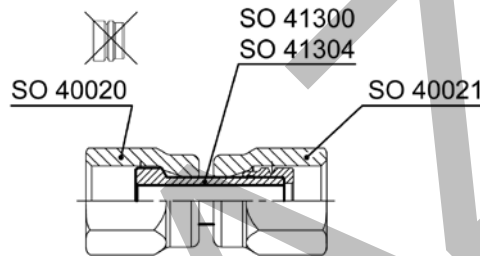

Werden die Verbindungsrippel mit einer Anschlussmutter und einem Armaturenanschluss (Anschlussmutter und Klemmring) verbunden, ergibt dies eine einstellbare Verschraubung.

Si l'insert de la pièce folle est relié à un écrou et à un écrou de raccordement (écrou et bague de serrage), cela fournit une union orientable.

If the tube stubs are coupled with a union nut and a nut connection (union nut and compression ferrule), an adjustable union is produced.

Auch vormontiert erhältlich (SO 41325 / SO 41326).

Aussi disponible pré-assemblé (SO 41325 / SO 41326).

Also available pre-assembled (SO 41325 / SO 41326).

Montagehinweis: Auf Seite des angedrehten Klemmringes (links im Bild) Anschlussmutter mit 1/4 Umdrehung anziehen. Auf Seite des Armaturenanschlusses (rechts im Bild) Anschlussmutter mit 1 3/4 Umdrehung anziehen.

Note d'installation: Serrez l'écrou sur le côté de la bague de serrage tournée (à gauche sur l'illustr.) de 1/4 de tour. Serrez l'écrou de l'autre côté (à droite sur l'illustr.) de 1 3/4 tour.

Assembly information: Tighten the union nut on the side of the turned compression ferrule (left in pict.) with 1/4 turn. Tighten the union nut on the other side (right in pict.) 1 3/4 turns.

Anwendungsbeispiele:

Exemples d'utilisation:

Sample combinations:

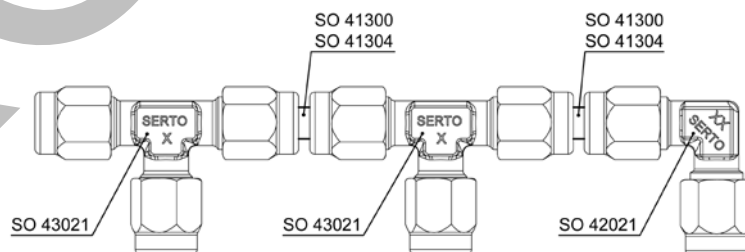

Mit der einstellbaren Verschraubung lassen sich Formteile mit dem gleichen Anschlussgewinde verbinden.

Avec l'union orientable, il est possible de connecter des raccords de même filetages.

With the adjustable union, parts with the same connecting thread can be connected.

Hinweis: Nur mit Verbindungsrippel SO 41304 ist eine radiale Demontage möglich.

Remarque: Un démontage radial n'est possible qu'avec la pièce folle SO 41304.

Note: Radial dismantling is only possible with tube stub SO 41304.

Einstellbare Verschraubung

Union orientable

Adjustable union

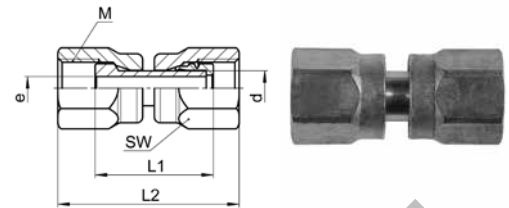

SO 41325

Type -d	Mat.-Nr.	bar	M	SW	L1	L2	e	kg/100
SO 41325-A6	018.1320.060	200	10x1.0	12	20.0	31.0	4.0	2.050
SO 41325-A8	018.1320.080	100	12x1.0	14	23.0	35.0	6.0	2.750
SO 41325-A10	018.1320.100	80	14x1.0	17	26.0	38.0	8.0	4.650
SO 41325-A12	018.1320.120	60	16x1.0	19	29.0	41.0	9.0	6.150
SO 41325-A14	018.1320.140	40	20x1.5	24	32.0	45.0	11.0	11.100
SO 41325-A15	018.1320.150	40	20x1.5	24	32.0	45.0	12.0	10.600
SO 41325-A18	018.1320.180	40	24x1.5	27	37.0	51.0	15.0	13.700
SO 41325-A22	018.1320.220	25	28x1.5	32	41.0	55.0	19.0	20.900
SO 41325-A28	018.1320.280	16	36x2.0	41	49.0	66.0	23.0	43.200

Einstellbare Verschraubung

radial demontierbar

Union orientable

démontable radialement

Adjustable union

radial dismantling

SO 41326

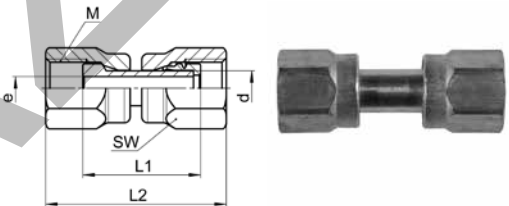

Type -d	Mat.-Nr.	bar	M	SW	L1	L2	e	kg/100
SO 41326-A6	018.1330.060	200	10x1.0	12	30.0	41.0	4.0	2.150
SO 41326-A8	018.1330.080	100	12x1.0	14	33.0	45.0	6.0	2.950
SO 41326-A10	018.1330.100	80	14x1.0	17	38.0	50.0	8.0	4.800
SO 41326-A12	018.1330.120	60	16x1.0	19	40.0	52.0	9.0	6.500

Mit der einstellbaren Verschraubung lassen sich Formteile mit dem gleichen Anschlussgewinde verbinden.

Montagehinweis: Beide Anschlussmutter mit 1/4 Umdrehung anziehen.
Wir empfehlen eine zusätzliche Schmierung auf der Planfläche.

Avec l'union orientable, il est possible de connecter des raccords de même filetages.

Note d'installation: Serrez les deux écrous de 1/4 de tour.
Nous recommandons une lubrification supplémentaire sur la surface plane.

With the adjustable union, parts with the same connecting thread can be connected.

Assembly information: Tighten both union nuts with 1/4 turn.
We recommend additional lubrication on the plane surface.

Verschraubung mit Einlötnippel
Union avec embout à braser
Adaptor union with soldering nipple

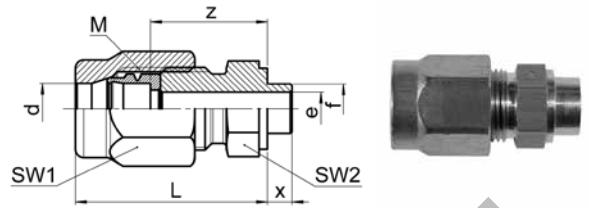

SO 41421

Type-d	Mat.-Nr.	bar	M	SW1	SW2	L	f	x	z	e	kg/100
Für metrische Rohre	Pour tubes métriques			For metric tubes							
* SO 41421-4	018.1400.060	125	10x1.0	12	10	21.5	6.0	3.0	14.0	3.4	1.640
* SO 41421-5	018.1400.080	125	10x1.0	12	10	21.5	6.0	3.0	14.0	4.0	1.590
SO 41421-6	018.1400.100	250	10x1.0	12	10	21.5	6.0	3.0	14.0	4.0	1.530
SO 41421-8	018.1400.140	150	12x1.0	14	12	24.0	9.0	4.0	16.0	6.0	2.200
SO 41421-10	018.1400.180	125	14x1.0	17	14	27.0	11.0	5.0	17.0	8.0	3.385
SO 41421-12	018.1400.200	100	16x1.0	19	17	29.0	14.0	6.0	18.0	10.0	4.530
* SO 41421-13	018.1400.240	40	20x1.5	24	22	33.0	17.0	6.0	20.5	11.0	8.330
SO 41421-14	018.1400.260	40	20x1.5	24	22	33.0	17.0	6.0	20.5	12.0	8.220
SO 41421-15	018.1400.280	40	20x1.5	24	22	33.0	17.0	6.0	20.5	13.0	7.900
SO 41421-16	018.1400.300	40	24x1.5	27	24	35.5	19.0	7.0	21.5	14.0	10.800
SO 41421-17	018.1400.320	40	24x1.5	27	24	35.5	19.0	7.0	21.5	15.0	10.550
SO 41421-18	018.1400.340	40	24x1.5	27	24	35.5	19.0	7.0	21.5	15.0	10.280
* SO 41421-19	018.1400.360	25	28x1.5	32	30	41.0	23.0	7.0	23.5	16.0	17.080
SO 41421-22	018.1400.400	25	28x1.5	32	30	41.0	23.0	7.0	23.5	19.0	15.680
Für Zollrohre	Pour tubes pouces			For inch tubes							
SO 41421-6,35	018.1400.120	250	10x1.0	12	10	21.5	6.0	3.0	14.0	4.0	1.520
SO 41421-9,52	018.1400.160	125	14x1.0	17	14	27.0	11.0	5.0	17.0	8.0	3.440
* SO 41421-12,7	018.1400.220	40	20x1.5	24	22	33.0	17.0	6.0	20.5	11.0	8.330

Umrechnung für "d" bei Zollrohren:

- 6,35 = 1/4
- 9,52 = 3/8
- 12,7 = 1/2

Conversion de "d" pour tubes en pouces:

- 6,35 = 1/4
- 9,52 = 3/8
- 12,7 = 1/2

Conversion for "d" for inch tubes:

- 6,35 = 1/4
- 9,52 = 3/8
- 12,7 = 1/2

Nach dem Anlöten die von SERTO empfohlenen Schmierstellen mit dem Spezial-Schmieröl AC 850 nochmals schmieren.

Après le brasage, graissez les points de lubrification nécessaires, conformément aux recommandations de SERTO, avec l'huile de lubrification spéciale AC 850.

After soldering, grease the necessary lubrication points as recommended by SERTO with the special lubrication oil AC 850.

d=Rohrassen-ø
 e=kleinste Bohrung
 L=Mass in montiertem Zustand
 *=mit reduziertem Klemmring

d=ø extérieur du tube
 e=ø-min. de passage
 L=après montage
 *=avec bague de serrage de réduction

d=tube outside diameter
 e=minimum bore
 L=installed length
 *=with reduction compression ferrule

Gerade Schottverschraubung

Durchführungslänge max. 5 mm

Union double traversée de cloison

pour cloison max. 5 mm

Panel mount union

max. panel thickness 5 mm

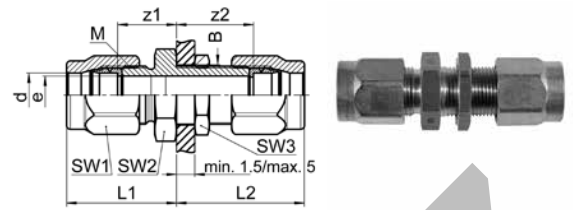

SO 41521

Type-d	Mat.-Nr.	bar	M	SW1	SW2	SW3	L1	L2	B	z1	z2	e	kg/100
Für metrische Rohre	Pour tubes métriques			For metric tubes									
* SO 41521-3	018.1500.030	125	8x1.0	10	12	12	20.0	25.5	8.5	13.5	19.0	2.5	2.580
SO 41521-4	018.1500.040	125	8x1.0	10	12	12	19.5	25.0	8.5	13.5	19.0	3.4	2.460
SO 41521-5	018.1500.050	125	8x1.0	10	12	12	20.0	25.5	8.5	13.5	19.0	3.5	2.440
SO 41521-6	018.1500.060	250	10x1.0	12	14	14	21.0	26.5	10.5	13.5	19.0	4.5	3.540
SO 41521-8	018.1500.080	150	12x1.0	14	17	17	23.0	28.0	12.5	15.0	20.0	6.5	5.320
SO 41521-10	018.1500.100	125	14x1.0	17	19	19	25.5	31.0	14.5	15.5	21.0	8.5	7.710
SO 41521-12	018.1500.120	100	16x1.0	19	22	19	27.0	32.0	16.5	16.0	21.0	10.0	9.320
* SO 41521-13	018.1500.130	40	20x1.5	24	27	27	32.0	37.0	20.5	19.5	24.5	11.0	16.510
SO 41521-14	018.1500.140	40	20x1.5	24	27	27	32.0	37.0	20.5	19.5	24.5	12.0	16.720
SO 41521-15	018.1500.150	40	20x1.5	24	27	27	32.0	37.0	20.5	19.5	24.5	13.0	16.080
SO 41521-16	018.1500.160	40	24x1.5	27	30	27	33.5	36.5	24.5	19.5	22.5	14.0	19.500
SO 41521-17	018.1500.170	40	24x1.5	27	30	27	33.5	36.5	24.5	19.5	22.5	15.0	19.000
SO 41521-18	018.1500.180	40	24x1.5	27	30	27	33.5	36.5	24.5	19.5	22.5	15.0	18.500
* SO 41521-19	018.1500.190	40	28x1.5	32	36	36	38.0	39.0	28.5	20.5	35.5	16.0	25.000
SO 41521-22	018.1500.220	40	28x1.5	32	36	36	38.0	39.0	28.5	20.5	35.5	19.0	23.300
Für Zollrohre	Pour tubes pouces			For inch tubes									
SO 41521-6,35	018.1500.063	250	10x1.0	12	14	14	21.0	26.5	10.5	13.5	19.0	4.5	3.510
SO 41521-9,52	018.1500.095	125	14x1.0	17	19	19	25.5	31.0	14.5	15.5	21.0	8.0	7.830
* SO 41521-12,7	018.1500.127	40	20x1.5	24	27	27	32.0	37.0	20.5	19.5	24.5	11.0	16.510

Umrechnung für "d" bei Zollrohren:

6,35 = 1/4
9,52 = 3/8
12,7 = 1/2

Conversion de "d" pour tubes en pouces:

6,35 = 1/4
9,52 = 3/8
12,7 = 1/2

Conversion for "d" for inch tubes:

6,35 = 1/4
9,52 = 3/8
12,7 = 1/2

Sechskantmutter siehe SO 40006 METR

Ecrou à six pans voir SO 40006 METR

Hexagon nut see SO 40006 METR

d=Rohrassens-ø
e=kleinste Bohrung
L=Mass in montiertem Zustand
*=mit reduziertem Klemmring

d=ø extérieur du tube
e=ø-min. de passage
L=après montage
*=avec bague de serrage de réduction

d=tube outside diameter
e=minimum bore
L=installed length
*=with reduction compression ferrule

Gerade Schottverschraubung reduziert

Durchführungslänge max. 5 mm

Union double réduite traversée de cloison

pour cloison max. 5 mm

Panel mount reduction union

max. panel thickness 5 mm

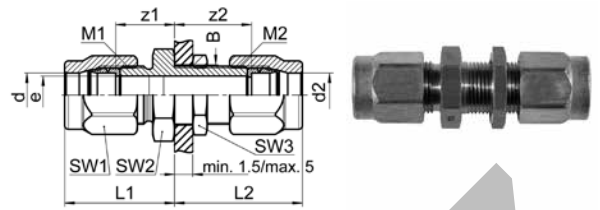

SO 41521 RED

Type -d -d2	Mat.-Nr.	bar	M1	M2	SW1	SW2	SW3	L1	L2	B	z1	z2	e	kg/100
Für metrische Rohre			Pour tubes métriques						For metric tubes					
* SO 41521-5-3	018.1504.060	125	8x1.0	8x1.0	10	12	12	20.5	25.5	8.5	13.5	19.0	2.5	2.500
* SO 41521-6-4	018.1504.110	100	10x1.0	10x1.0	12	14	14	21.0	26.5	10.5	13.5	19.0	3.4	3.650
* SO 41521-6-5	018.1504.117	100	10x1.0	10x1.0	12	14	14	21.0	26.5	10.5	13.5	19.0	4.0	3.600
* SO 41521-8-6	018.1504.140	250	12x1.0	12x1.0	14	17	17	23.0	28.0	12.5	15.0	20.0	4.5	5.480
* SO 41521-10-8	018.1504.190	150	14x1.0	14x1.0	17	19	19	25.5	31.0	14.5	15.5	21.0	6.5	7.910
* SO 41521-12-10	018.1504.240	100	16x1.0	16x1.0	19	22	19	27.0	32.0	16.5	16.0	21.0	8.5	9.600
* SO 41521-15-12	018.1504.420	40	20x1.5	20x1.5	24	27	27	32.0	37.0	20.5	19.5	24.5	10.0	16.620
* SO 41521-15-13	018.1504.430	40	20x1.5	20x1.5	24	27	27	32.0	37.0	20.5	19.5	24.5	11.0	16.510
* SO 41521-18-15	018.1504.610	40	24x1.5	24x1.5	27	30	27	33.5	36.5	24.5	19.5	22.5	18.0	18.400

Für Zollrohre			Pour tubes pouces						For inch tubes					
SO 41521-6-6,35	018.1504.119	250	10x1.0	10x1.0	12	14	14	21.0	26.5	10.5	13.5	19.0	4.5	3.530
SO 41521-10-9,52	018.1504.197	125	14x1.0	14x1.0	17	19	19	25.5	31.0	14.5	15.5	21.0	8.0	7.780
* SO 41521-15-12,7	018.1504.427	40	20x1.5	20x1.5	24	27	27	32.0	37.0	20.5	19.5	24.5	11.0	16.510

Umrechnung für "d" bei Zollrohren:

6,35 = 1/4
9,52 = 3/8
12,7 = 1/2

Conversion de "d" pour tubes en pouces:

6,35 = 1/4
9,52 = 3/8
12,7 = 1/2

Conversion for "d" for inch tubes:

6,35 = 1/4
9,52 = 3/8
12,7 = 1/2

Weitere Reduktionen siehe SO 41821.
Sechskantmutter siehe SO 40006 METR.

Autres réductions voir SO 41821.
Ecroû à six pans voir SO 40006 METR.

Alternative reductions see SO 41821.
Hexagon nut see SO 40006 METR.

d=Rohrassen-ø
e=kleinste Bohrung
L=Mass in montiertem Zustand
*=mit reduziertem Klemmring

d=ø extérieur du tube
e=ø-min. de passage
L=après montage
*=avec bague de serrage de réduction

d=tube outside diameter
e=minimum bore
L=installed length
*=with reduction compression ferrule

Gerade Schottverschraubung

Durchführungslänge max. 16 mm

Union double traversée de cloison

pour cloison max. 16 mm

Panel mount union

max. panel thickness 16 mm

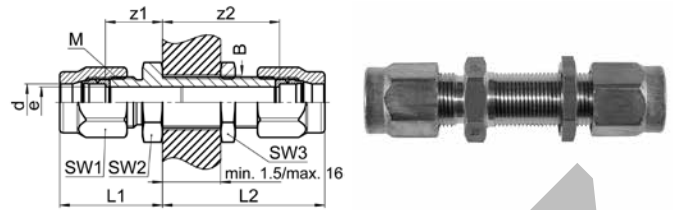

SO 41524

Type-d	Mat.-Nr.	bar	M	SW1	SW2	SW3	L1	L2	B	z1	z2	e	kg/100
Für metrische Rohre	Pour tubes métriques			For metric tubes									
* SO 41524-4	018.1540.040	125	10x1.0	12	14	14	21.0	37.5	10.5	13.5	30.0	3.4	4.130
* SO 41524-5	018.1540.050	125	10x1.0	12	14	14	21.0	37.5	10.5	13.5	30.0	4.0	4.080
SO 41524-6	018.1540.060	250	10x1.0	12	14	14	21.0	37.5	10.5	13.5	30.0	4.5	4.020
SO 41524-8	018.1540.080	150	12x1.0	14	17	17	23.0	40.0	12.5	15.0	32.0	6.5	6.030
SO 41524-10	018.1540.100	125	14x1.0	17	19	19	25.5	42.0	14.5	15.5	32.0	8.5	8.520
SO 41524-12	018.1540.120	100	16x1.0	19	22	19	27.0	43.0	16.5	16.0	32.0	10.0	10.220
* SO 41524-13	018.1540.130	40	20x1.5	24	27	27	32.0	46.0	20.5	19.5	33.5	11.0	17.740
SO 41524-14	018.1540.140	40	20x1.5	24	27	27	32.0	46.0	20.5	19.5	33.5	12.0	17.950
SO 41524-15	018.1540.150	40	20x1.5	24	27	27	32.0	46.0	20.5	19.5	33.5	13.0	17.310
SO 41524-16	018.1540.160	40	24x1.5	27	30	27	33.0	47.5	24.5	19.5	33.5	14.0	25.800
SO 41524-17	018.1540.170	40	24x1.5	27	30	27	33.0	47.5	24.5	19.5	33.5	15.0	25.350
SO 41524-18	018.1540.180	40	24x1.5	27	30	27	33.0	47.5	24.5	19.5	33.5	15.0	24.850
* SO 41524-19	018.1540.190	40	28x1.5	32	36	36	38.0	53.0	28.5	20.5	35.5	16.0	34.200
SO 41524-22	018.1540.220	40	28x1.5	32	36	36	38.0	53.0	28.5	20.5	35.5	19.0	31.500

Für Zollrohre	Pour tubes pouces			For inch tubes									
SO 41524-6,35	018.1540.063	250	10x1.0	12	14	14	21.0	37.5	10.5	13.5	30.0	4.5	3.990
SO 41524-9,52	018.1540.095	125	14x1.0	17	19	19	25.5	42.0	14.5	15.5	32.0	8.0	8.640
* SO 41524-12,7	018.1540.127	40	20x1.5	24	27	27	32.0	46.0	20.5	19.5	33.5	11.0	17.740

Umrechnung für "d" bei Zollrohren:

- 6,35 = 1/4
- 9,52 = 3/8
- 12,7 = 1/2

Conversion de "d" pour tubes en pouces:

- 6,35 = 1/4
- 9,52 = 3/8
- 12,7 = 1/2

Conversion for "d" for inch tubes:

- 6,35 = 1/4
- 9,52 = 3/8
- 12,7 = 1/2

Sechskantmutter siehe SO 40006 METR

Ecrou à six pans voir SO 40006 METR

Hexagon nut see SO 40006 METR

d=Rohrassen-ø
 e=kleinste Bohrung
 L=Mass in montiertem Zustand
 *=mit reduziertem Klemmring

d=ø extérieur du tube
 e=ø-min. de passage
 L=après montage
 *=avec bague de serrage de réduction

d=tube outside diameter
 e=minimum bore
 L=installed length
 *=with reduction compression ferrule

Gerade Schottverschraubung reduziert

Durchführungslänge max. 16 mm

Union double réduite traversée de cloison

pour cloison max. 16 mm

Panel mount reduction union

max. panel thickness 16 mm

SO 41524 RED

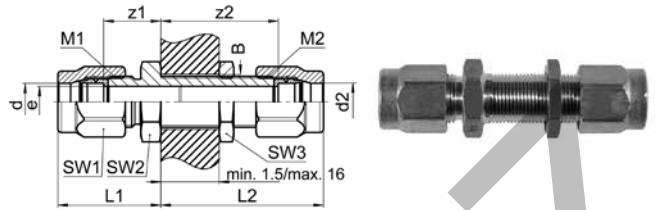

Type -d -d2	Mat.-Nr.	bar	M1	M2	SW1	SW2	SW3	L1	L2	B	z1	z2	e	kg/100
Für metrische Rohre			Pour tubes métriques					For metric tubes						
* SO 41524-6-4	018.1544.110	100	10x1.0	10x1.0	12	14	14	21.0	37.5	10.5	13.5	30.0	3.4	4.130
* SO 41524-6-5	018.1544.117	100	10x1.0	10x1.0	12	14	14	21.0	37.5	10.5	13.5	30.0	4.0	4.080
* SO 41524-8-6	018.1544.140	250	12x1.0	12x1.0	14	17	17	23.0	40.0	12.5	15.0	32.0	4.5	6.190
* SO 41524-10-8	018.1544.190	150	14x1.0	14x1.0	17	19	19	25.5	42.0	14.5	15.5	32.0	6.5	8.720
* SO 41524-12-10	018.1544.240	100	16x1.0	16x1.0	19	22	19	27.0	43.0	16.5	16.0	32.0	8.5	10.500
* SO 41524-15-12	018.1544.420	40	20x1.5	20x1.5	24	27	27	32.0	46.0	20.5	19.5	33.5	10.0	17.850
* SO 41524-15-13	018.1544.430	40	20x1.5	20x1.5	24	27	27	32.0	46.0	20.5	19.5	33.5	11.0	17.740

Für Zollrohre			Pour tubes pouces					For inch tubes						
SO 41524-6-6,35	018.1544.119	250	10x1.0	10x1.0	12	14	14	22.5	37.5	10.5	13.5	30.0	4.5	4.010
SO 41524-10-9,52	018.1544.197	125	14x1.0	14x1.0	17	19	19	28.0	42.0	14.5	15.5	32.0	8.0	8.580
* SO 41524-15-12,7	018.1544.427	40	20x1.5	20x1.5	24	27	27	30.5	47.5	20.5	19.5	33.5	11.0	17.740

Umrechnung für "d" bei Zollrohren:

6,35 = 1/4
9,52 = 3/8
12,7 = 1/2

Conversion de "d" pour tubes en pouces:

6,35 = 1/4
9,52 = 3/8
12,7 = 1/2

Conversion for "d" for inch tubes:

6,35 = 1/4
9,52 = 3/8
12,7 = 1/2

Weitere Reduktionen siehe SO 41821.
Sechskantmutter siehe SO 40006 METR.

Autres réductions voir SO 41821.
Ecrou à six pans voir SO 40006 METR.

Alternative reductions see SO 41821.
Hexagon nut see SO 40006 METR.

d=Rohraussen-ø
e=kleinste Bohrung
L=Mass in montiertem Zustand
*=mit reduziertem Klemmring

d=ø extérieur du tube
e=ø-min. de passage
L=après montage
*=avec bague de serrage de réduction

d=tube outside diameter
e=minimum bore
L=installed length
*=with reduction compression ferrule

Einstellnippel Adaptateur orientable mâle Adjustable male adaptor

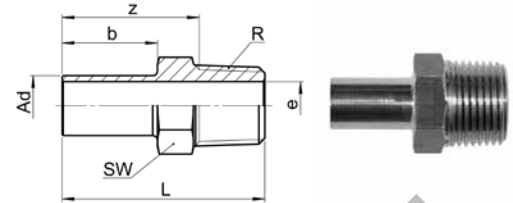
SO 41600

Type -Ad -R	Mat.-Nr.	bar	SW	L	b	z	e	kg/100
R=Rohrgewinde (kegelig)	R=Filetage-gaz BSP (conique)			R=BSP thread (tapered)				
SO 41600-A6-1/8	016.1601.100	200	12	26.0	13.0	19.5	4.0	1.000
SO 41600-A6-1/4	016.1601.110	200	14	31.0	13.0	21.5	4.0	1.950
SO 41600-A8-1/8	016.1601.160	100	12	28.0	14.0	21.5	6.0	1.200
SO 41600-A8-1/4	016.1601.170	100	14	32.0	14.0	22.5	6.0	1.800
SO 41600-A10-1/4	016.1601.270	80	14	34.0	16.0	24.5	8.0	1.650
SO 41600-A10-3/8	016.1601.280	80	17	34.0	16.0	24.0	8.0	2.900
SO 41600-A10-1/2	016.1601.285	80	22	39.0	16.0	27.5	8.0	5.570
SO 41600-A12-1/4	016.1601.380	60	14	36.0	18.0	26.5	9.0	1.750
SO 41600-A12-3/8	016.1601.390	60	17	36.0	18.0	26.0	9.0	3.000
SO 41600-A12-1/2	016.1601.400	60	22	41.0	18.0	29.5	9.0	5.670
SO 41600-A14-1/2	016.1601.504	40	22	44.0	21.0	32.5	11.0	5.650
SO 41600-A15-3/8	016.1601.532	40	17	39.0	21.0	29.0	10.5	3.200

Einstellnippel NPT Adaptateur orientable mâle NPT Adjustable male adaptor NPT

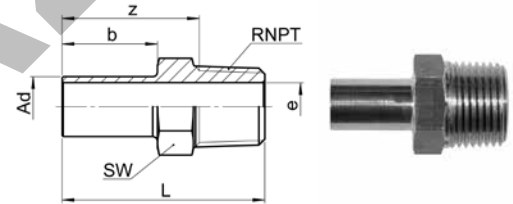
SO 41600 NPT

Type -Ad -RNPT	Mat.-Nr.	bar	SW	L	b	z	e	kg/100
RNPT=NPT Gewinde	RNPT=Filetage NPT			RNPT=NPT thread				
SO 41600-A6-1/8 NPT	016.1602.100	200	12	27.5	13.0	20.0	4.0	1.150
SO 41600-A6-1/4 NPT	016.1602.110	200	14	32.5	13.0	23.0	4.0	2.200
SO 41600-A8-1/8 NPT	016.1602.160	100	12	28.5	14.0	21.5	6.0	1.100
SO 41600-A8-1/4 NPT	016.1602.170	100	14	33.5	14.0	24.0	6.0	1.900
SO 41600-A10-1/4 NPT	016.1602.270	80	14	35.5	16.0	26.0	8.0	2.050
SO 41600-A10-3/8 NPT	016.1602.280	80	17	36.0	16.0	26.0	8.0	2.900
SO 41600-A10-1/2 NPT	016.1602.285	80	22	42.0	16.0	28.0	8.0	5.800
SO 41600-A12-1/4 NPT	016.1602.380	60	14	37.5	18.0	28.0	9.0	2.250
SO 41600-A12-3/8 NPT	016.1602.390	60	17	38.0	18.0	28.0	9.0	3.100
SO 41600-A12-1/2 NPT	016.1602.400	60	22	44.0	18.0	30.0	9.0	5.750
SO 41600-A14-1/2 NPT	016.1602.504	40	22	47.0	21.0	33.0	11.0	5.850
SO 41600-A15-3/8 NPT	016.1602.532	40	17	41.0	21.0	31.0	10.5	5.700
SO 41600-A15-1/2 NPT	016.1602.534	40	22	47.0	21.0	33.0	12.0	5.800

Fortsetzung nächste Seite

Suite à la prochaine page

Continued on next page

Einstellnippel

radial demontierbar

Adaptateur orientable mâle

démontable radialement

Adjustable male adaptor

radial dismantling

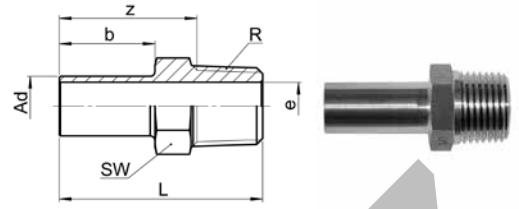

SO 41604

Type -Ad -R	Mat.-Nr.	bar	SW	L	b	z	e	kg/100
R=Rohrgewinde (kegelig)	R=Filetage-gaz BSP (conique)	R=BSP thread (tapered)						
SO 41604-A15-1/2	016.1611.534	40	22	53.0	30.0	40.0	12.0	5.760
SO 41604-A15-3/4	016.1611.536	40	27	55.0	30.0	40.0	12.0	7.800
SO 41604-A22-1	016.1611.770	25	36	65.0	36.0	48.5	18.0	16.540
SO 41604-A28-1 1/4	016.1611.860	16	46	75.5	41.5	56.5	23.0	33.860

Anwendungsbeispiele:

Exemples d'utilisation:

Sample combinations:

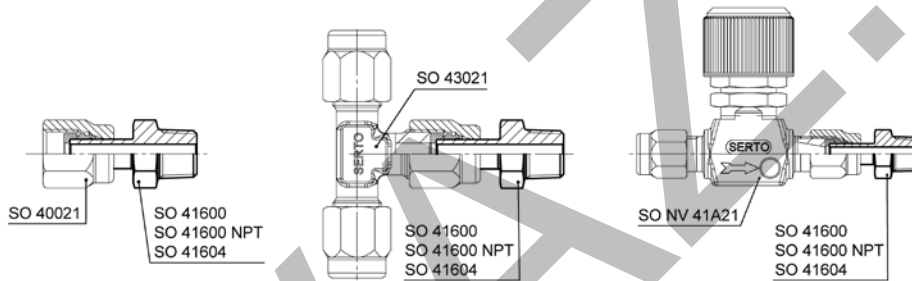

Mögliche Kombinationen:

- mit Armaturenanschluss zu einstellbaren Einschraubverschraubungen
- mit Verschraubungen/Ventilen zu einstellbaren Verschraubungen/Ventilen

Hinweis: Nur mit Einstellnippel SO 41604 ist eine radiale Demontage möglich.

Combinaisons possibles:

- avec écrou de raccordement ça donne des unions mâle orientables
- avec raccords/vannes ça donne des raccords/vannes orientables

Remarque: Un démontage radial n'est possible qu'avec l'union orientable mâle SO 41604.

Possible combinations:

- with nut connection to adjustable male adaptor unions
- with unions/valves to adjustable unions/valves

Note: Radial dismantling is only possible with adjustable male adaptor SO 41604.

Einstellbare Einschraubverschraubung Union mâle orientable Adjustable male adaptor union

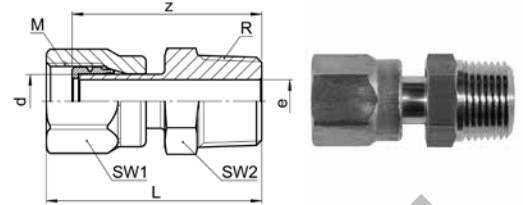

SO 41625

Type -d-R	Mat.-Nr.	bar	M	SW1	SW2	L	z	e	kg/100
R=Rohrgewinde (kegelig)	R=Filetage-gaz BSP (conique)	R=BSP thread (tapered)							
SO 41625-A6-1/8	018.1621.100	200	10x1.0	12	12	32.5	27.0	4.0	1.840
SO 41625-A6-1/4	018.1621.110	200	10x1.0	12	14	37.5	32.0	4.0	2.790
SO 41625-A8-1/8	018.1621.160	100	12x1.0	14	12	35.5	29.0	6.0	2.320
SO 41625-A8-1/4	018.1621.170	100	12x1.0	14	14	39.5	33.0	6.0	2.920
SO 41625-A10-1/4	018.1621.270	80	14x1.0	17	14	41.0	35.0	8.0	3.540
SO 41625-A10-3/8	018.1621.280	80	14x1.0	17	17	41.0	35.0	8.0	6.760
SO 41625-A10-1/2	018.1621.285	80	14x1.0	17	22	46.0	40.0	8.0	7.460
SO 41625-A12-1/4	018.1621.380	60	16x1.0	19	14	43.0	37.0	8.0	4.090
SO 41625-A12-3/8	018.1621.390	60	16x1.0	19	17	43.0	37.0	9.0	5.340
SO 41625-A12-1/2	018.1621.400	60	16x1.0	19	22	48.0	42.0	9.0	8.010
SO 41625-A14-1/2	018.1621.504	40	20x1.5	24	22	52.0	45.0	11.0	10.210
SO 41625-A15-3/8	018.1621.532	40	20x1.5	24	17	47.0	40.5	10.5	7.440

Einstellbare Einschraubverschraubung NPT Union mâle orientable NPT Adjustable male adaptor union NPT

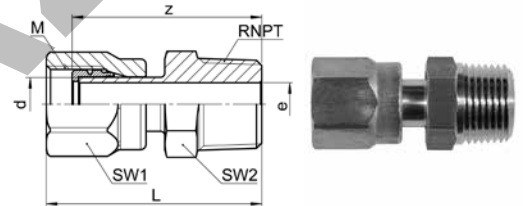

SO 41625 NPT

Type -d-RNPT	Mat.-Nr.	bar	M	SW1	SW2	L	z	e	kg/100
RNPT=NPT Gewinde	RNPT=Filetage NPT	RNPT=NPT thread							
SO 41625-A6-1/8 NPT	018.1622.100	200	10x1.0	12	12	34.0	22.5	4.0	1.700
SO 41625-A6-1/4 NPT	018.1622.110	200	10x1.0	12	14	39.0	33.5	4.0	1.750
SO 41625-A8-1/8 NPT	018.1622.160	100	12x1.0	14	12	36.0	29.5	6.0	2.250
SO 41625-A8-1/4 NPT	018.1622.170	100	12x1.0	14	14	41.0	34.5	6.0	3.020
SO 41625-A10-1/4 NPT	018.1622.270	80	14x1.0	17	14	42.5	36.0	8.0	3.940
SO 41625-A10-3/8 NPT	018.1622.280	80	14x1.0	17	17	43.0	37.0	8.0	4.790
SO 41625-A10-1/2 NPT	018.1622.285	80	14x1.0	17	22	49.0	43.0	8.0	7.690
SO 41625-A12-1/4 NPT	018.1622.380	60	16x1.0	19	14	44.5	38.5	8.5	4.590
SO 41625-A12-3/8 NPT	018.1622.390	60	16x1.0	19	17	45.0	39.0	9.0	5.440
SO 41625-A12-1/2 NPT	018.1622.400	60	16x1.0	19	22	51.0	45.0	9.0	8.090
SO 41625-A14-1/2 NPT	018.1622.504	40	20x1.5	24	22	55.0	48.5	11.0	10.410
SO 41625-A15-3/8 NPT	018.1622.532	40	20x1.5	24	17	49.0	42.5	10.5	9.940
SO 41625-A15-1/2 NPT	018.1622.534	40	20x1.5	24	22	55.0	48.5	12.0	10.040

Montagehinweis: Anschlussmutter mit 1/4 Umdrehung anziehen.

Wir empfehlen eine zusätzliche Schmierung auf der Planfläche.

Note d'installation: Serrez l'écrou de 1/4 de tour.

Nous recommandons une lubrification supplémentaire sur la surface plane.

Assembly information: Tighten the union nut with 1/4 turn.

We recommend additional lubrication on the plane surface.

Einstellbare Einschraubverschraubung

radial demontierbar

Union mâle orientable

démontable radialement

Adjustable male adaptor union

radial dismantling

SO 41626

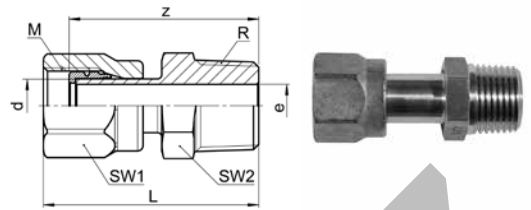

Type -d-R	Mat.-Nr.	bar	M	SW1	SW2	L	z	e	kg/100
R=Rohrgewinde (kegelig)	R=Filetage-gaz BSP (conique)								

Montagehinweis: Anschlussmutter mit 1/4 Umdrehung anziehen.
Wir empfehlen eine zusätzliche Schmierung auf der Planfläche.

Note d'installation: Serrez l'écrou de 1/4 de tour.
Nous recommandons une lubrification supplémentaire sur la surface plane.

Assembly information: Tighten the union nut with 1/4 turn.
We recommend additional lubrication on the plane surface.

Einstellmuffe

radial demontierbar

Adaptateur orientable femelle

démontable radialement

Adjustable female adaptor

radial dismantling

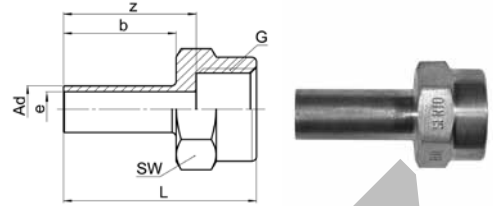

SO 41704

Type -Ad -G	Mat.-Nr.	bar	SW	L	b	z	e	kg/100
G=Rohrgewinde (zylindrisch)	G=Filetage-gaz BSP (cylindrique)	G=BSP thread (parallel)						
SO 41704-A12- $\frac{3}{8}$	016.1711.390	60	22	44.0	28.0	32.0	9.0	4.350
SO 41704-A12- $\frac{1}{2}$	016.1711.400	60	27	48.0	28.0	33.0	9.0	5.500
SO 41704-A15- $\frac{1}{2}$	016.1711.534	40	27	50.0	30.0	35.0	12.0	7.540
SO 41704-A15- $\frac{3}{4}$	016.1711.536	40	36	54.0	30.0	37.0	12.0	15.310
SO 41704-A22-1	016.1711.770	25	41	64.0	36.0	44.0	18.0	21.390
SO 41704-A28-1 $\frac{1}{4}$	016.1711.860	16	50	72.5	41.5	49.5	23.0	32.960

Anwendungsbeispiele:

Exemples d'utilisation:

Sample combinations:

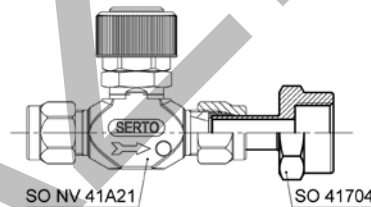
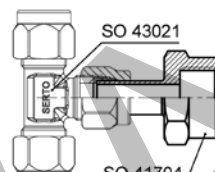
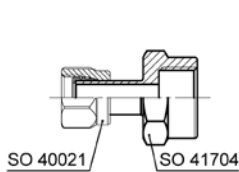

Mögliche Kombinationen:

- mit Armaturenanschluss zu einstellbaren Aufschraubverschraubungen
- mit Verschraubungen/Ventilen zu einstellbaren Verschraubungen/Ventilen

Auch vormontiert erhältlich (SO 41726).

Combinaisons possibles:

- avec écrou de raccordement ça donne des raccords femelle orientables
- avec raccords/vannes ça donne des raccords/vannes orientables

Aussi disponible pré-assemblé (SO 41726).

Possible combinations:

- with nut connection to adjustable female adaptor unions
- with unions/valves to adjustable unions/valves

Also available pre-assembled (SO 41726).

Einstellbare Aufschraubverschraubung

radial demontierbar

Union femelle orientable

démontable radialement

Adjustable female adaptor union

radial dismantling

SO 41726

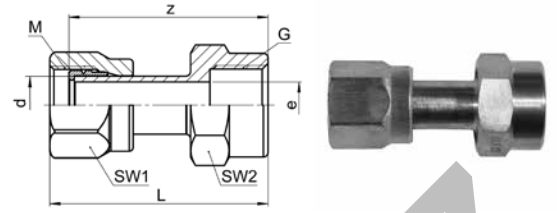

Type -d-G	Mat.-Nr.	bar	M	SW1	SW2	L	z	e	kg/100
G=Rohrgewinde (zylindrisch)	G=Filetage-gaz BSP (cylindrique)	G=BSP thread (parallel)							
SO 41726-A12- ³ / ₈	018.1731.390	60	16x1.0	19	22	52.5	45.0	9.0	6.690
SO 41726-A12- ¹ / ₂	018.1731.400	60	16x1.0	19	27	56.5	49.0	9.0	7.840
SO 41726-A15- ¹ / ₂	018.1731.534	40	20x1.5	24	27	58.5	51.5	12.0	11.780
SO 41726-A15- ³ / ₄	018.1731.536	40	20x1.5	24	36	62.5	55.5	12.0	19.550
SO 41726-A22-1	018.1731.770	25	28x1.5	32	41	74.0	65.5	18.0	29.810
SO 41726-A28-1 ¹ / ₄	018.1731.860	16	36x2.0	41	50	84.5	74.5	23.0	49.660

Montagehinweis: Anschlussmutter mit 1/4 Umdrehung anziehen.
Wir empfehlen eine zusätzliche Schmierung auf der Planfläche.

Note d'installation: Serrez l'écrou de 1/4 de tour.
Nous recommandons une lubrification supplémentaire sur la surface plane.

Assembly information: Tighten the union nut with 1/4 turn.
We recommend additional lubrication on the plane surface.

KONVANT

d=Rohrassens-ø
e=kleinste Bohrung
L=Mass in montiertem Zustand

d=ø extérieur du tube
e=ø-min. de passage
L=après montage

d=tube outside diameter
e=minimum bore
L=installed length

Reduktionsverschraubung

für Grundteile

Union de réduction

pour corps de raccord

Reduction union

for union body

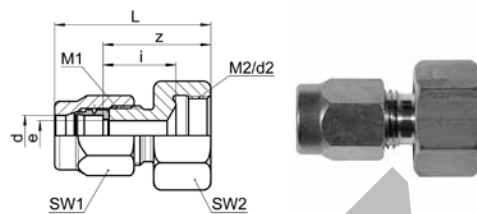

SO 41821

Type -d2-d	Mat.-Nr.	bar	M1	M2	SW1	SW2	L	i	z	e	kg/100	
Für metrische Rohre	Pour tubes métriques			For metric tubes								
SO 41821-8-10	018.1820.083	125	14x1.0	12x1.0	17	17	34.0	7.0	14.0	6.5	4.310	
* SO 41821-10-4	018.1800.167	125	10x1.0	14x1.0	12	17	27.5	7.0	13.0	3.4	2.580	
* SO 41821-10-5	018.1800.170	125	10x1.0	14x1.0	12	17	27.5	7.0	13.0	4.0	2.530	
SO 41821-10-6	018.1800.175	125	10x1.0	14x1.0	12	17	27.5	7.0	13.0	4.5	2.470	
* SO 41821-12-6	018.1800.215	100	12x1.0	16x1.0	14	19	29.5	7.0	14.5	4.5	3.500	
SO 41821-12-8	018.1800.225	100	12x1.0	16x1.0	14	19	29.5	7.0	14.5	6.0	3.340	
* SO 41821-15-8	018.1800.400	40	14x1.0	20x1.5	17	24	33.5	8.0	15.5	6.5	5.920	
SO 41821-15-10	018.1800.410	40	14x1.0	20x1.5	17	24	33.5	8.0	15.5	8.0	5.720	
* SO 41821-18-10	018.1800.575	40	16x1.0	24x1.5	19	30	35.5	8.0	16.5	8.5	9.100	
SO 41821-18-12	018.1800.580	40	16x1.0	24x1.5	19	30	35.5	8.0	16.5	10.0	8.820	
* SO 41821-22-12	018.1800.730	25	20x1.5	28x1.5	24	36	39.0	8.0	18.5	10.0	15.140	
* SO 41821-22-13	018.1800.735	25	20x1.5	28x1.5	24	36	39.0	8.0	18.5	11.0	15.100	
SO 41821-22-14	018.1800.740	25	20x1.5	28x1.5	24	36	39.0	8.0	18.5	12.0	14.920	
SO 41821-22-15	018.1800.745	25	20x1.5	28x1.5	24	36	39.0	8.0	18.5	12.0	14.600	
* SO 41821-28-17	018.1800.868	16	28x1.5	36x2.0	32	41	50.0	10.0	22.5	15.0	25.300	
* SO 41821-28-18	018.1800.870	16	28x1.5	36x2.0	32	41	50.0	10.0	22.5	16.0	25.150	
* SO 41821-28-19	018.1800.875	16	28x1.5	36x2.0	32	41	50.0	10.0	22.5	16.0	24.840	
SO 41821-28-22	018.1800.900	16	28x1.5	36x2.0	32	41	50.0	10.0	22.5	19.0	23.620	
Für Zollrohre	Pour tubes pouces			For inch tubes								
SO 41821-10-6,35	018.1800.177	125	10x1.0	14x1.0	12	17	27.5	7.0	13.0	4.5	2.460	
SO 41821-15-9,52	018.1800.408	40	14x1.0	20x1.5	17	24	33.5	8.0	15.5	8.0	5.780	
* SO 41821-22-12,7	018.1800.732	25	20x1.5	28x1.5	24	36	39.0	8.0	18.5	11.0	15.100	

Umrechnung für "d" bei Zollrohren:

- 6,35 = 1/4
- 9,52 = 3/8
- 12,7 = 1/2

Conversion de "d" pour tubes en pouces:

- 6,35 = 1/4
- 9,52 = 3/8
- 12,7 = 1/2

Conversion for "d" for inch tubes:

- 6,35 = 1/4
- 9,52 = 3/8
- 12,7 = 1/2

Fortsetzung nächste Seite

Suite à la prochaine page

Continued on next page

d=Rohrassen-ø
 e=kleinste Bohrung
 L=Mass in montiertem Zustand
 *=mit reduziertem Klemmring

d=ø extérieur du tube
 e=ø-min. de passage
 L=après montage
 *=avec bague de serrage de réduction

d=tube outside diameter
 e=minimum bore
 L=installed length
 *=with reduction compression ferrule

Anwendungsbeispiele:

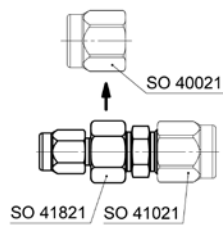

Exemples d'utilisation:

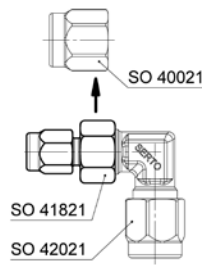

Sample combinations:

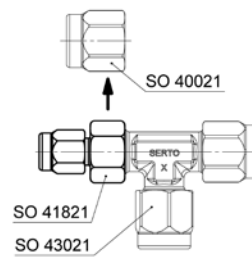

Die Reduktion SO 41821 kann auf jedes SERTO Formteil mit dem passenden Gewinde geschraubt werden und muss mit 1/4 Umdrehung angezogen werden. Durch diese Kombination ergeben sich weitere Rohrreduktionen.

Dichtungsprinzip: Bei der Montage drückt sich die Dichtkante des Übergangstückes in das SERTO Formteil ein. Dadurch entsteht eine einwandfreie metallische Dichtung. Wir empfehlen, das Gewinde mit einem geeigneten Flüssigklebstoff gegen unbeabsichtigtes Lösen zu sichern.

La réduction SO 41821 peut être vissée sur chacune des pièces moulées SERTO avec le filetage correspondant et doit être serré de 1/4 de tour. Cette combinaison permet encore plus des réductions.

Principe d'étanchéité: Lors du montage, l'arête d'étanchéité du réducteur s'appuie sur la pièce moulée SERTO. Cela crée un joint métallique parfait. Nous recommandons de fixer le filetage avec une colle liquide appropriée pour empêcher le desserrage involontaire.

The SO 41821 reduction can be screwed onto all SERTO moulded parts with a matching thread and must be tightened with 1/4 turn. This combination enables further tube reductions.

Sealing principle: On assembly, the sealing edge of the transition piece presses into the SERTO moulded part. This produces a perfect metallic seal. We recommend that the thread is secured against accidental unscrewing by means of a suitable liquid adhesive.

KONVART

d=Rohrassen-ø
e=kleinste Bohrung
L=Mass in montiertem Zustand
*=mit reduziertem Klemmring

d=ø extérieur du tube
e=ø-min. de passage
L=après montage
*=avec bague de serrage de réduction

d=tube outside diameter
e=minimum bore
L=installed length
*=with reduction compression ferrule

Winkelverschraubung

Coude

Elbow union

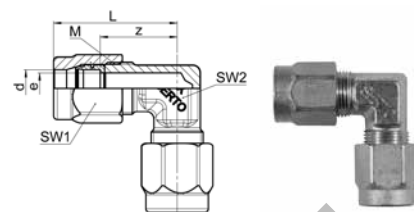

SO 42021

Type-d	Mat.-Nr.	bar	M	SW1	SW2	L	z	e	kg/100
Für metrische Rohre	Pour tubes métriques	For metric tubes							
SO 42021-2	018.2000.020	125	6x0.75	8	7	16.5	12.5	1.5	1.000
SO 42021-3	018.2000.030	125	6x0.75	8	7	18.0	13.0	2.5	1.000
SO 42021-4	018.2000.040	125	8x1.0	10	7	22.0	16.0	3.4	1.940
SO 42021-5	018.2000.050	125	8x1.0	10	7	22.5	16.0	4.0	1.920
SO 42021-6	018.2000.060	250	10x1.0	12	10	23.5	16.0	4.0	2.750
SO 42021-8	018.2000.080	150	12x1.0	14	10	26.0	18.0	6.0	3.680
SO 42021-10	018.2000.100	125	14x1.0	17	14	30.5	20.5	8.0	6.340
SO 42021-12	018.2000.120	100	16x1.0	19	17	32.5	21.5	10.0	8.700
* SO 42021-13	018.2000.130	40	20x1.5	24	19	36.0	23.5	11.0	13.540
SO 42021-14	018.2000.140	40	20x1.5	24	19	36.0	23.5	12.0	13.750
SO 42021-15	018.2000.150	40	20x1.5	24	19	36.0	23.5	12.0	13.110
SO 42021-16	018.2000.160	40	24x1.5	27	22	40.5	26.5	14.0	18.540
SO 42021-17	018.2000.170	40	24x1.5	27	22	40.5	26.5	15.0	18.560
SO 42021-18	018.2000.180	40	24x1.5	27	22	40.5	26.5	15.0	18.020
* SO 42021-19	018.2000.190	25	28x1.5	32	27	48.0	30.5	16.0	28.600
SO 42021-22	018.2000.220	25	28x1.5	32	27	48.0	30.5	19.0	26.400
SO 42021-28	018.2000.280	16	36x2.0	41	32	58.5	39.0	24.0	38.300
SO 42021-35	018.2000.350	16	42x2.0	50	41	67.0	45.0	30.0	64.600
Für Zollrohre	Pour tubes pouces	For inch tubes							
SO 42021-3,2	018.2000.032	125	6x0.75	8	7	18.0	13.0	2.5	0.920
SO 42021-6,35	018.2000.063	250	10x1.0	12	10	23.5	16.0	4.0	2.720
SO 42021-9,52	018.2000.095	125	14x1.0	17	14	30.5	20.5	8.0	6.460
* SO 42021-12,7	018.2000.127	40	20x1.5	24	19	36.0	23.5	11.0	13.540
SO 42021-15,88	018.2000.158	40	24x1.5	27	22	40.5	26.5	14.0	18.540

Umrechnung für "d" bei Zollrohren:

3,2 = 1/8
 6,35 = 1/4
 9,52 = 3/8
 12,7 = 1/2
 15,88 = 5/8

Conversion de "d" pour tubes en pouces:

3,2 = 1/8
 6,35 = 1/4
 9,52 = 3/8
 12,7 = 1/2
 15,88 = 5/8

Conversion for "d" for inch tubes:

3,2 = 1/8
 6,35 = 1/4
 9,52 = 3/8
 12,7 = 1/2
 15,88 = 5/8

Winkelverschraubung reduziert
Coude réduit
Elbow reduction union

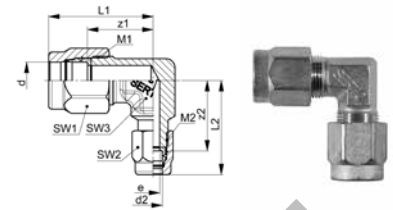

SO 42021 RED

Type -d-d2	Mat.-Nr.	bar	M1	M2	SW1	SW2	SW3	L1	L2	z1	z2	e	kg/100	
Für metrische Rohre	Pour tubes métriques			For metric tubes										
* SO 42021-5-3	018.2004.060	125	8x1.0	8x1.0	10	10	7	22.5	22.5	16.0	16.0	2.5	2.000	
* SO 42021-6-4	018.2004.110	100	10x1.0	10x1.0	12	12	10	23.5	23.5	16.0	16.0	3.4	2.860	
* SO 42021-6-5	018.2004.117	100	10x1.0	10x1.0	12	12	10	23.5	23.5	16.0	16.0	4.0	2.810	
* SO 42021-8-6	018.2004.140	250	12x1.0	12x1.0	14	14	10	26.0	26.0	18.0	18.0	4.5	3.740	
* SO 42021-10-6	018.2004.175	150	16x1.0	10x1.0	19	17	17	32.5	31.0	21.5	23.0	4.0	6.540	
* SO 42021-10-8	018.2004.190	150	14x1.0	14x1.0	17	17	14	30.5	30.5	20.5	20.5	6.5	6.540	
SO 42021-12-6	018.2004.215	100	16x1.0	10x1.0	19	12	17	32.5	30.5	21.5	23.0	4.0	9.000	
* SO 42021-12-10	018.2004.240	100	16x1.0	16x1.0	19	19	17	32.5	32.5	21.5	21.5	8.5	9.000	
* SO 42021-14-12	018.2004.340	40	20x1.5	20x1.5	24	24	19	36.0	36.0	23.5	23.5	10.0	14.130	
* SO 42021-15-12	018.2004.420	40	20x1.5	20x1.5	24	24	19	36.0	36.0	23.5	23.5	10.0	13.650	
* SO 42021-15-13	018.2004.430	40	20x1.5	20x1.5	24	24	19	36.0	36.0	23.5	23.5	11.0	13.540	
* SO 42021-17-14	018.2004.530	40	24x1.5	24x1.5	27	27	22	40.5	40.5	26.5	26.5	12.0	19.270	
* SO 42021-18-15	018.2004.610	40	24x1.5	24x1.5	27	27	22	40.5	40.5	26.5	26.0	13.0	18.720	
SO 42021-18-16	018.2004.620	40	24x1.5	24x1.5	27	27	22	40.5	40.5	26.5	26.5	14.0	18.530	
* SO 42021-22-17	018.2004.750	25	28x1.5	28x1.5	32	32	27	48.0	48.0	30.5	30.5	15.0	28.060	
* SO 42021-22-18	018.2004.755	25	28x1.5	28x1.5	32	32	27	48.0	48.0	30.5	30.5	16.0	27.880	
* SO 42021-22-19	018.2004.760	25	28x1.5	28x1.5	32	32	27	48.0	48.0	30.5	30.5	16.0	27.620	
Für Zollrohre	Pour tubes pouces			For inch tubes										
SO 42021-6-6,35	018.2004.119	250	10x1.0	10x1.0	12	12	10	23.5	23.5	16.0	16.0	4.0	2.740	
SO 42021-10-9,52	018.2004.197	125	14x1.0	14x1.0	17	17	14	30.5	30.5	20.5	20.5	8.0	6.450	
* SO 42021-15-12,7	018.2004.427	40	20x1.5	20x1.5	24	24	19	36.0	36.0	23.5	23.5	11.0	13.540	

Umrechnung für "d" bei Zollrohren:
 6,35 = 1/4
 9,52 = 3/8
 12,7 = 1/2

Conversion de "d" pour tubes en pouces:
 6,35 = 1/4
 9,52 = 3/8
 12,7 = 1/2

Conversion for "d" for inch tubes:
 6,35 = 1/4
 9,52 = 3/8
 12,7 = 1/2

Weitere Reduktionen siehe SO 41821

Autres réductions voir SO 41821

Alternative reductions see SO 41821

d=Rohrassens-ø
 e=kleinste Bohrung
 L=Mass in montiertem Zustand
 *=mit reduziertem Klemmring

d=ø extérieur du tube
 e=ø-min. de passage
 L=après montage
 *=avec bague de serrage de réduction

d=tube outside diameter
 e=minimum bore
 L=installed length
 *=with reduction compression ferrule

Winkelverschraubung

mit Übergangsnippel SO 40040

Coude

avec adaptateur mâle SO 40040

Elbow union

with male adaptor SO 40040

SO 42121

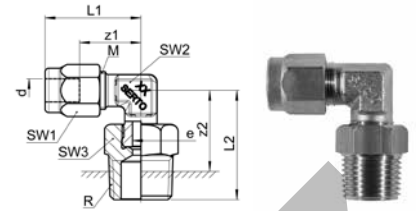

Type -d-R	Mat.-Nr.	bar	M	SW1	SW2	SW3	L1	L2	z1	z2	e	kg/100
R=Rohrgewinde (kegelig)												
				R=Filetage-gaz BSP (conique)								
				R=BSP thread (tapered)								
* SO 42121-4-3/8	018.2101.068	125	10x1.0	12	7	17	23.5	29.0	16.0	19.0	3.4	5.040
SO 42121-6-1/8	018.2101.100	250	10x1.0	12	10	12	23.5	26.0	16.0	19.0	4.0	3.240
SO 42121-6-1/4	018.2101.110	250	10x1.0	12	10	14	23.5	30.0	16.0	20.0	4.0	4.400
SO 42121-6-3/8	018.2101.120	250	10x1.0	12	10	17	23.5	29.0	16.0	19.0	4.0	4.930
SO 42121-6-1/2	018.2101.125	250	10x1.0	12	10	22	23.5	32.0	16.0	18.0	4.0	7.480
SO 42121-8-1/8	018.2101.160	150	12x1.0	14	10	14	26.0	28.0	18.0	21.0	6.0	4.070
SO 42121-8-1/4	018.2101.170	150	12x1.0	14	10	14	26.0	32.0	18.0	22.0	6.0	4.710
SO 42121-8-3/8	018.2101.180	150	12x1.0	14	10	17	26.0	32.0	18.0	22.0	6.0	6.210
SO 42121-10-1/4	018.2101.270	125	14x1.0	17	14	17	31.5	34.5	21.5	24.5	8.0	6.990
SO 42121-10-3/8	018.2101.280	125	14x1.0	17	14	17	31.5	34.5	21.5	24.5	8.0	7.810
SO 42121-10-1/2	018.2101.285	100	14x1.0	17	14	22	31.5	36.5	21.5	25.5	8.0	7.840
SO 42121-12-1/4	018.2101.380	100	16x1.0	19	17	19	32.5	36.5	21.5	26.5	8.5	9.010
SO 42121-12-3/8	018.2101.390	100	16x1.0	19	17	19	32.5	36.5	21.5	26.5	10.0	9.450
SO 42121-12-1/2	018.2101.400	100	16x1.0	19	17	22	32.5	39.5	21.5	28.0	10.0	12.290
SO 42121-28-1	018.2101.850	16	36x2.0	41	32	41	58.5	65.0	39.0	48.0	24.0	36.430
SO 42121-35-1 1/4	018.2101.944	16	42x2.0	50	41	50	67.0	73.0	40.0	59.0	30.0	62.000

Montagehinweis: Nippel ist handfest montiert. Bei Endmontage mit 1/4 Umdrehung anziehen.
Wir empfehlen eine zusätzliche Schmierung auf der Planfläche.

Note d'installation: L'adaptateur femelle-mâle est monté serré à la main. Pour le montage final, serrer avec 1/4 de tour.
Nous recommandons une lubrification supplémentaire sur la surface plane.

Assembly information: Male adaptor is mounted finger-tight. For final assembly, tighten with 1/4 turn.
We recommend additional lubrication on the plane surface.

d=Rohrassen-ø
e=kleinste Bohrung
L=Mass in montiertem Zustand
*=mit reduziertem Klemmring

d=ø extérieur du tube
e=ø-min. de passage
L=après montage
*=avec bague de serrage de réduction

d=tube outside diameter
e=minimum bore
L=installed length
*=with reduction compression ferrule

Winkelverschraubung

mit Übergangsnippel SO 40040 NPT

Coude

avec adaptateur mâle SO 40040 NPT

Elbow union

with male adaptor SO 40040 NPT

SO 42121 NPT

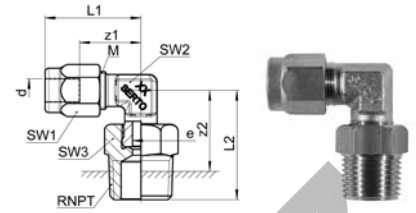

Type -d -RNPT	Mat.-Nr.	bar	M	SW1	SW2	SW3	L1	L2	z1	z2	e	kg/100
Für metrische Rohre												
RNPT=NPT Gewinde												
SO 42121-6-1/4 NPT	018.2102.110	250	10x1.0	12	10	14	23.5	32.0	16.0	22.0	4.0	4.720
SO 42121-8-1/8 NPT	018.2102.160	150	12x1.0	14	7	14	26.0	34.0	18.0	27.0	6.0	3.550
Für Zollrohre												
SO 42121-6,35-1/4 NPT	018.2102.140	250	10x1.0	12	7	14	23.5	32.0	16.0	22.0	4.0	3.920

Umrechnung für "d" bei Zollrohren:
6,35 = 1/4

Conversion de "d" pour tubes en pouces:
6,35 = 1/4

Conversion for "d" for inch tubes:
6,35 = 1/4

Montagehinweis: Nippel ist handfest montiert. Bei Endmontage mit 1/4 Umdrehung anziehen.
Wir empfehlen eine zusätzliche Schmierung auf der Planfläche.

Note d'installation: L'adaptateur femelle-mâle est monté serré à la main. Pour le montage final, serrer avec 1/4 de tour.
Nous recommandons une lubrification supplémentaire sur la surface plane.

Assembly information: Male adaptor is mounted finger-tight. For final assembly, tighten with 1/4 turn.
We recommend additional lubrication on the plane surface.

d=Rohrassen-ø
e=kleinste Bohrung
L=Mass in montiertem Zustand
*=mit reduziertem Klemmring

d=ø extérieur du tube
e=ø-min. de passage
L=après montage
*=avec bague de serrage de réduction

d=tube outside diameter
e=minimum bore
L=installed length
*=with reduction compression ferrule

Winkelverschraubung

mit Übergangsmuffe SO 40030

Coude

avec adaptateur femelle SO 40030

Elbow union

with female adaptor SO 40030

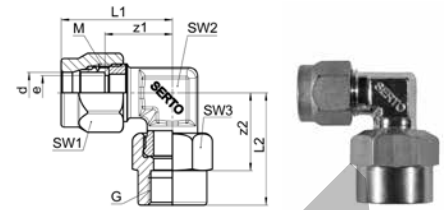

SO 42221

Type -d-G	Mat.-Nr.	bar	M	SW1	SW2	SW3	L1	L2	z1	z2	e	kg/100
Für metrische Rohre	Pour tubes métriques						For metric tubes					
G=Rohrgewinde (zylindrisch)	G=Filetage-gaz BSP (cylindrique)						G=BSP thread (parallel)					
SO 42221-6-1/8	018.2201.100	250	10x1.0	12	10	14	23.5	29.0	16.0	19.0	4.0	3.580
SO 42221-6-1/4	018.2201.110	250	10x1.0	12	10	17	23.5	30.0	16.0	19.0	4.0	4.440
SO 42221-6-3/8	018.2201.120	250	10x1.0	12	10	22	23.5	31.0	16.0	19.0	4.0	6.710
SO 42221-8-1/8	018.2201.160	150	12x1.0	14	10	17	26.0	31.0	18.0	21.0	6.0	5.460
SO 42221-8-1/4	018.2201.170	150	12x1.0	14	10	17	26.0	33.0	18.0	22.0	6.0	5.370
SO 42221-10-1/4	018.2201.270	125	14x1.0	17	14	17	30.5	34.5	20.5	23.5	8.0	6.740
SO 42221-10-3/8	018.2201.280	125	14x1.0	17	14	22	30.5	35.5	20.5	23.5	8.0	9.220
* SO 42221-10-1/2	018.2201.285	100	16x1.0	19	17	27	32.5	38.5	21.5	24.5	8.5	12.180
SO 42221-12-1/4	018.2201.380	100	16x1.0	19	17	19	32.5	35.5	21.5	24.5	10.0	7.010
SO 42221-12-3/8	018.2201.390	100	16x1.0	19	17	22	32.5	36.5	21.5	25.5	10.0	9.250
SO 42221-14-3/4	018.2201.506	64	20x1.5	24	19	32	36.0	44.0	23.5	27.0	12.0	20.170
SO 42221-15-3/8	018.2201.532	64	20x1.5	24	19	24	36.0	39.0	23.5	27.0	12.0	13.970
SO 42221-15-3/4	018.2201.536	64	20x1.5	24	19	32	36.0	44.0	23.5	27.0	12.0	19.850
SO 42221-28-1	018.2201.850	16	36x2.0	41	32	41	58.5	64.0	39.0	44.0	24.0	38.230
Für Zollrohre	Pour tubes pouces						For inch tubes					
SO 42221-6,35-1/4	018.2201.140	250	10x1.0	12	10	17	23.5	30.0	16.0	19.0	4.0	4.420

Umrechnung für "d" bei Zollrohren:
6,35 = 1/4

Conversion de "d" pour tubes en pouces:
6,35 = 1/4

Conversion for "d" for inch tubes:
6,35 = 1/4

Montagehinweis: Muffe ist handfest montiert. Bei Endmontage mit 1/4 Umdrehung anziehen.
Wir empfehlen eine zusätzliche Schmierung auf der Planfläche.

Note d'installation: L'adaptateur femelle est monté serré à la main. Pour le montage final, serrer avec 1/4 de tour.
Nous recommandons une lubrification supplémentaire sur la surface plane.

Assembly information: Female adaptor is mounted finger-tight. For final assembly, tighten with 1/4 turn.
We recommend additional lubrication on the plane surface.

d=Rohrassen-ø
e=kleinste Bohrung
L=Mass in montiertem Zustand
*=mit reduziertem Klemming

d=ø extérieur du tube
e=ø-min. de passage
L=après montage
*=avec bague de serrage de réduction

d=tube outside diameter
e=minimum bore
L=installed length
*=with reduction compression ferrule

Anschlusswinkel

mit Wandflansch

Coude femelle

avec applique de fixation

Female adaptor elbow union

with wall flange

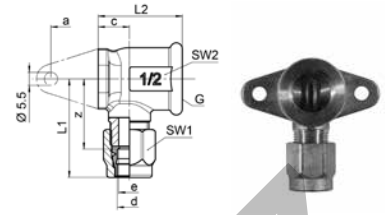

SO 42321

Type -d-G	Mat.-Nr.	bar	M	SW1	SW2	L1	L2	a	c	z	e	kg/100
Für metrische Rohre	Pour tubes métriques			For metric tubes								
G=Rohrgewinde (zylindrisch)	G=Filetage-gaz BSP (cylindrique)			G=BSP thread (parallel)								
* SO 42321-8- ³ / ₈	018.2301.180	150	14x1.0	17	22	34.5	27.0	40.0	11.0	24.5	6.5	10.140
SO 42321-10- ³ / ₈	018.2301.280	125	14x1.0	17	22	34.5	27.0	40.0	11.0	24.5	8.0	9.940
* SO 42321-10- ¹ / ₂	018.2301.285	100	16x1.0	19	27	41.0	35.0	40.0	13.0	29.0	8.5	14.080
SO 42321-12- ³ / ₈	018.2301.390	100	16x1.0	19	27	36.0	27.0	40.0	11.0	25.0	10.0	10.160
SO 42321-12- ¹ / ₂	018.2301.400	100	16x1.0	19	27	41.0	35.0	40.0	13.0	29.0	10.0	13.800
* SO 42321-13- ¹ / ₂	018.2301.454	40	20x1.5	24	27	43.0	36.0	40.0	14.0	30.5	11.0	16.230
SO 42321-14- ¹ / ₂	018.2301.504	40	20x1.5	24	27	43.0	36.0	40.0	14.0	30.5	12.0	16.120
SO 42321-15- ¹ / ₂	018.2301.534	40	20x1.5	24	27	43.0	36.0	40.0	14.0	30.5	13.0	15.800
Für Zollrohre	Pour tubes pouces			For inch tubes								
SO 42321-9,52- ³ / ₈	018.2301.235	125	14x1.0	17	22	34.5	27.0	40.0	11.0	24.5	8.0	10.000
* SO 42321-12,7- ¹ / ₂	018.2301.434	40	20x1.5	24	27	43.0	36.0	40.0	14.0	30.5	11.0	16.230

Umrechnung für "d" bei Zollrohren:

9,52 = 3/8

12,7 = 1/2

Conversion de "d" pour tubes en pouces:

9,52 = 3/8

12,7 = 1/2

Conversion for "d" for inch tubes:

9,52 = 3/8

12,7 = 1/2

d=Rohrassen-ø
e=kleinste Bohrung
L=Mass in montiertem Zustand
*=mit reduziertem Klemmring

d=ø extérieur du tube
e=ø-min. de passage
L=après montage
*=avec bague de serrage de réduction

d=tube outside diameter
e=minimum bore
L=installed length
*=with reduction compression ferrule

Winkel-Einschraubverschraubung

Coude mâle

Male adaptor elbow union

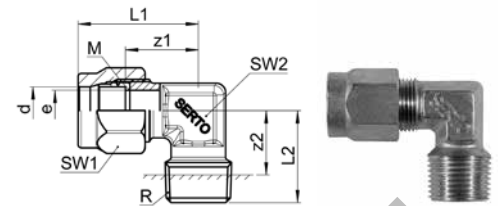

SO 42421

Type -d-R	Mat.-Nr.	bar	M	SW1	SW2	L1	L2	z1	z2	e	kg/100
Für metrische Rohre R=Rohrgewinde (kegelig)	Pour tubes métriques R=Filetage-gaz BSP (conique)	For metric tubes R=BSP thread (tapered)									
* SO 42421-3-1/8	018.2401.040	125	8x1.0	10	7	22.5	17.0	16.0	11.0	2.5	1.600
SO 42421-4-1/8	018.2401.060	125	8x1.0	10	7	22.0	17.0	16.0	11.0	3.4	1.560
* SO 42421-4-1/4	018.2401.065	100	10x1.0	12	10	25.5	22.5	18.0	13.0	3.4	3.000
SO 42421-5-1/8	018.2401.082	125	8x1.0	12	7	22.5	17.0	16.0	11.0	4.0	1.540
* SO 42421-5-1/4	018.2401.084	100	10x1.0	12	10	25.5	22.5	18.0	13.0	4.0	2.940
SO 42421-6-1/8	018.2401.100	250	10x1.0	12	10	23.5	17.5	16.0	12.0	4.5	2.150
SO 42421-6-1/4	018.2401.110	250	10x1.0	12	10	25.5	22.5	18.0	13.0	4.0	2.880
SO 42421-8-1/8	018.2401.160	150	12x1.0	14	10	26.0	18.0	18.0	11.5	6.0	2.540
SO 42421-8-1/4	018.2401.170	150	12x1.0	14	10	26.0	22.5	18.0	13.0	6.0	3.090
* SO 42421-8-3/8	018.2401.180	150	14x1.0	17	14	30.5	25.0	20.5	15.0	6.5	5.310
SO 42421-10-1/4	018.2401.270	125	14x1.0	17	14	30.5	25.0	20.5	15.5	8.0	4.640
SO 42421-10-3/8	018.2401.280	125	14x1.0	19	14	30.5	25.0	20.5	15.0	8.0	5.110
* SO 42421-10-1/2	018.2401.285	100	16x1.0	19	19	34.0	29.5	23.0	16.5	8.5	9.020
SO 42421-12-1/4	018.2401.380	100	16x1.0	19	17	32.5	26.0	21.5	16.5	8.0	8.480
SO 42421-12-3/8	018.2401.390	100	16x1.0	19	17	32.5	26.0	21.5	16.0	10.0	6.120
SO 42421-12-1/2	018.2401.400	100	16x1.0	19	19	34.0	29.5	23.0	18.0	10.0	8.710
* SO 42421-13-1/2	018.2401.454	40	20x1.5	24	19	36.0	29.5	23.5	18.0	11.0	10.380
SO 42421-14-3/8	018.2401.502	40	20x1.5	24	19	36.0	28.0	23.5	18.0	10.0	7.570
SO 42421-14-1/2	018.2401.504	40	20x1.5	24	19	36.0	29.5	23.5	18.0	12.0	10.270
* SO 42421-14-3/4	018.2401.506	40	24x1.5	27	22	40.5	35.0	26.5	21.0	12.0	16.100
SO 42421-15-3/8	018.2401.532	40	20x1.5	24	19	36.0	28.0	23.5	18.0	10.0	7.350
SO 42421-15-1/2	018.2401.534	40	20x1.5	24	19	36.0	29.5	23.5	18.0	13.0	9.950
* SO 42421-15-3/4	018.2401.536	40	24x1.5	27	22	40.5	35.0	26.5	21.0	13.0	15.900
SO 42421-16-1/2	018.2401.566	40	24x1.5	27	22	40.5	31.5	26.5	20.0	14.0	13.040
SO 42421-16-3/4	018.2401.568	40	24x1.5	27	22	40.5	35.0	26.5	21.0	14.0	15.670
SO 42421-17-1/2	018.2401.596	40	24x1.5	27	22	40.5	31.5	26.5	20.0	15.0	12.790
SO 42421-17-3/4	018.2401.598	40	24x1.5	27	22	40.5	35.0	26.5	21.0	15.0	15.420
SO 42421-18-1/2	018.2401.646	40	24x1.5	27	22	40.5	31.5	26.5	20.0	15.0	12.520
SO 42421-18-3/4	018.2401.648	40	24x1.5	27	22	40.5	35.0	26.5	21.0	15.0	15.150
* SO 42421-19-3/4	018.2401.678	25	28x1.5	32	27	48.0	35.5	30.5	21.0	16.0	19.600
SO 42421-22-3/4	018.2401.768	25	28x1.5	32	27	48.0	35.5	30.5	21.0	19.0	18.500
Für Zollrohre	Pour tubes pouces	For inch tubes									
* SO 42421-3,2-1/8	018.2401.042	125	8x1.0	10	7	22.0	17.0	16.0	11.0	2.5	1.600
SO 42421-6,35-1/8	018.2401.135	250	10x1.0	12	10	23.5	17.5	16.0	11.0	4.0	2.140
SO 42421-6,35-1/4	018.2401.140	250	10x1.0	12	10	25.5	22.5	18.0	13.0	4.0	2.870
SO 42421-9,52-1/4	018.2401.230	125	14x1.0	17	14	30.5	25.0	20.5	15.5	8.0	4.700
SO 42421-9,52-3/8	018.2401.235	125	14x1.0	17	14	30.5	25.0	20.5	15.0	8.0	5.170
* SO 42421-12,7-1/2	018.2401.434	40	20x1.5	24	19	36.0	29.5	23.5	18.0	11.0	10.380
SO 42421-15,88-1/2	018.2401.541	40	24x1.5	27	22	40.5	31.5	26.5	20.0	14.0	13.040

Umrechnung für "d" bei Zollrohren:

- 3,2 = 1/8
- 6,35 = 1/4
- 9,52 = 3/8
- 12,7 = 1/2
- 15,88 = 5/8

Conversion de "d" pour tubes en pouces:

- 3,2 = 1/8
- 6,35 = 1/4
- 9,52 = 3/8
- 12,7 = 1/2
- 15,88 = 5/8

Conversion for "d" for inch tubes:

- 3,2 = 1/8
- 6,35 = 1/4
- 9,52 = 3/8
- 12,7 = 1/2
- 15,88 = 5/8

d=Rohrassen-ø
e=kleinste Bohrung
L=Mass in montiertem Zustand
*=mit reduziertem Klemmring

d=ø extérieur du tube
e=ø-min. de passage
L=après montage
*=avec bague de serrage de réduction

d=tube outside diameter
e=minimum bore
L=installed length
*=with reduction compression ferrule

Winkel-Einschraubverschraubung NPT
Coude mâle NPT
Male adaptor elbow union NPT

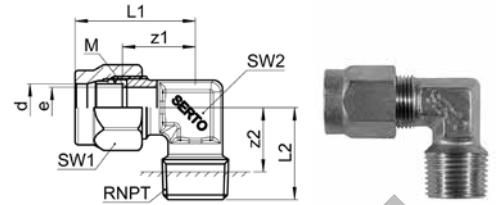

SO 42421 NPT

Type -d -RNPT	Mat.-Nr.	bar	M	SW1	SW2	L1	L2	z1	z2	e	kg/100
Für metrische Rohre RNPT=NPT Gewinde	Pour tubes métriques RNPT=Filetage NPT	For metric tubes RNPT=NPT thread									
★ SO 42421-3-1/8 NPT	018.2402.040	125	8x1.0	10	7	22.5	17.0	16.0	10.5	2.5	1.550
SO 42421-4-1/8 NPT	018.2402.060	125	8x1.0	10	7	22.0	17.0	16.0	10.5	3.4	1.510
SO 42421-5-1/8 NPT	018.2402.082	125	8x1.0	10	7	22.5	17.0	16.0	10.5	4.0	1.490
SO 42421-6-1/8 NPT	018.2402.100	250	10x1.0	12	10	23.5	17.5	16.0	11.0	4.0	2.020
★ SO 42421-6-1/4 NPT	018.2402.110	250	12x1.0	14	10	26.0	22.5	18.0	12.5	4.5	3.260
SO 42421-8-1/4 NPT	018.2402.170	150	12x1.0	14	10	26.0	22.5	18.0	12.5	6.0	3.100
SO 42421-8-3/8 NPT	018.2402.180	150	14x1.0	17	14	30.5	25.0	20.5	15.5	6.0	5.100
SO 42421-10-1/4 NPT	018.2402.270	125	14x1.0	17	14	30.5	25.0	20.5	15.0	8.0	4.610
SO 42421-10-3/8 NPT	018.2402.280	125	14x1.0	17	14	30.5	25.0	20.5	15.5	8.0	4.900
SO 42421-10-1/2 NPT	018.2402.285	125	16x1.0	19	19	34.0	29.5	23.0	16.0	8.0	9.050
SO 42421-12-3/8 NPT	018.2402.390	100	16x1.0	19	17	32.5	26.0	21.5	15.5	10.0	6.100
SO 42421-12-1/2 NPT	018.2402.400	100	16x1.0	19	19	34.0	29.5	23.0	16.0	10.0	8.700
Für Zollrohre	Pour tubes pouces	For inch tubes									
SO 42421-6,35-1/8 NPT	018.2402.135	250	10x1.0	12	10	23.5	17.5	16.0	11.0	4.0	2.010
SO 42421-9,52-1/4 NPT	018.2402.230	125	14x1.0	17	14	30.5	25.0	20.5	15.0	8.0	4.670
SO 42421-9,52-3/8 NPT	018.2402.235	125	14x1.0	17	14	30.5	25.0	20.5	15.5	8.0	4.960

Umrechnung für "d" bei Zollrohren:
 6,35 = 1/4
 9,52 = 3/8

Conversion de "d" pour tubes en pouces:
 6,35 = 1/4
 9,52 = 3/8

Conversion for "d" for inch tubes:
 6,35 = 1/4
 9,52 = 3/8

d=Rohrassen-ø
 e=kleinste Bohrung
 L=Mass in montiertem Zustand
 *=mit reduziertem Klemmring

d=ø extérieur du tube
 e=ø-min. de passage
 L=après montage
 *=avec bague de serrage de réduction

d=tube outside diameter
 e=minimum bore
 L=installed length
 *=with reduction compression ferrule

Winkel-Einschraubverschraubung METR
Coude mâle METR
Male adaptor elbow union METR

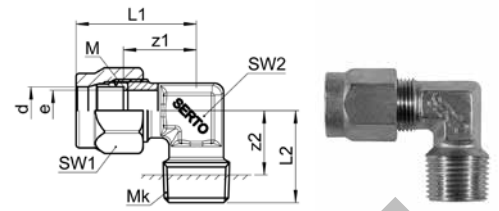

SO 42421 METR

Type -d -Mk	Mat.-Nr.	bar	M	SW1	SW2	L1	L2	z1	z2	e	kg/100
Für metrische Rohre Mk=metrisches Gewinde (kegelig)	Pour tubes métriques Mk=Filetage métrique (conique)										
For metric tubes Mk=metric thread (tapered)											
* SO 42421-3-M8x1	018.2403.060	125	8x1.0	10	7	22.5	17.0	16.0	10.0	2.5	1.370
SO 42421-4-M8x1	018.2403.090	125	8x1.0	10	7	22.0	17.0	16.0	10.0	3.4	1.330
* SO 42421-4-M10x1	018.2403.096	125	10x1.0	12	10	23.5	17.5	16.0	10.5	3.4	2.120
SO 42421-5-M8x1	018.2403.125	125	8x1.0	10	7	22.5	17.0	16.0	10.0	4.0	1.310
* SO 42421-5-M10x1	018.2403.135	125	10x1.0	12	10	23.5	17.5	16.0	10.5	4.0	2.070
SO 42421-6-M10x1	018.2403.180	250	10x1.0	12	10	23.5	17.5	16.0	10.5	4.0	2.010
Für Zollrohre	Pour tubes pouces										
For inch tubes											
SO 42421-6,35-M10x1	018.2403.210	250	10x1.0	12	10	23.5	17.5	16.0	10.5	4.0	2.000

Umrechnung für "d" bei Zollrohren:
 6,35 = 1/4

Conversion de "d" pour tubes en pouces:
 6,35 = 1/4

Conversion for "d" for inch tubes:
 6,35 = 1/4

d=Rohrassens-ø
 e=kleinste Bohrung
 L=Mass in montiertem Zustand
 *=mit reduziertem Klemmring

d=ø extérieur du tube
 e=ø-min. de passage
 L=après montage
 *=avec bague de serrage de réduction

d=tube outside diameter
 e=minimum bore
 L=installed length
 *=with reduction compression ferrule

Winkel-Einschraubverschraubung METR

Coude mâle METR

Male adaptor elbow union METR

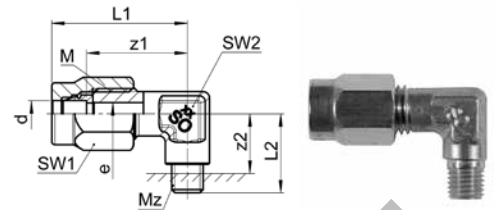

SO 42424 METR

Type -d -Mz	Mat.-Nr.	bar	M	SW1	SW2	L1	L2	z1	z2	e	kg/100
Mz=metrisches Gewinde (zylindrisch)	Mz=Filetage métrique (cylindrique)	Mz=Metric thread (parallel)									
SO 42424-2-M5	018.2443.020	125	6x0.75	8	7	16.5	12.0	12.5	8.5	1.5	0.770
SO 42424-3-M5	018.2443.050	125	6x0.75	8	7	18.0	12.0	13.0	8.5	2.5	0.810
* SO 42424-3-M6x0,75	018.2443.055	125	8x1.0	10	7	22.5	14.0	16.0	9.0	2.5	1.260
SO 42424-4-M5	018.2443.080	125	8x1.0	10	7	22.0	12.5	16.0	9.0	2.5	1.170
SO 42424-4-M6x0,75	018.2443.085	125	8x1.0	10	7	22.0	14.0	16.0	9.0	2.5	1.220
SO 42424-5-M5	018.2443.110	125	8x1.0	10	7	22.5	12.5	16.0	9.0	2.5	1.150
SO 42424-5-M6x0,75	018.2443.115	125	8x1.0	10	7	22.5	14.0	16.0	9.0	2.5	1.200

Anwendungsbeispiele:

Exemples d'utilisation:

Sample combinations:

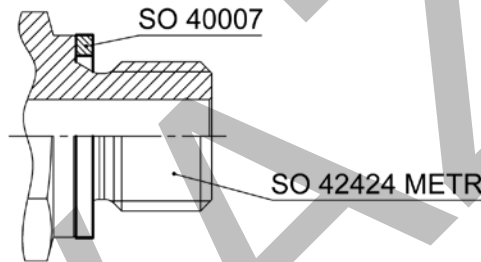

Wir empfehlen die Verwendung der Dichtung SO 40007 oder SO 40507.
Die entsprechende Dichtung SO 40007 / SO 40507 ist separat zu bestellen.

Nous recommandons l'utilisation du joint SO 40007 ou SO 40507.
Le joint correspondant SO 40007 / SO 40507 doit être commandé séparément.

We recommend the use of the washer SO 40007 or SO 40507.
The relevant washer SO 40007 / SO 40507 must be ordered separately.

Winkel-Aufschraubverschraubung

Coude femelle

Female adaptor elbow union

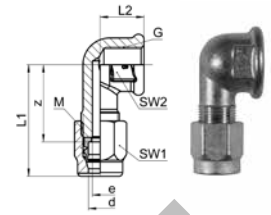

SO 42521

Type -d-G	Mat.-Nr.	bar	M	SW1	SW2	L1	L2	z	e	kg/100
Für metrische Rohre G=Rohrgewinde (zylindrisch)	Pour tubes métriques G=Filetage-gaz BSP (cylindrique)	For metric tubes G=BSP thread (parallel)								
* SO 42521-3-1/8	018.2501.040	125	8x1.0	10	14	26.5	11.5	20.0	2.5	2.250
SO 42521-4-1/8	018.2501.060	125	8x1.0	10	14	26.0	11.5	20.0	3.4	2.220
SO 42521-5-1/8	018.2501.082	125	8x1.0	10	14	26.5	11.5	20.0	4.0	2.190
SO 42521-6-1/8	018.2501.100	250	10x1.0	12	14	27.5	11.5	20.0	4.0	2.600
* SO 42521-6-1/4	018.2501.110	250	12x1.0	14	19	31.5	13.5	23.5	4.5	4.460
SO 42521-8-1/4	018.2501.170	150	12x1.0	14	19	31.5	13.5	23.5	6.0	4.300
* SO 42521-8-3/8	018.2501.180	150	14x1.0	17	22	34.5	16.0	24.5	6.5	6.590
SO 42521-10-3/8	018.2501.280	125	14x1.0	17	22	34.5	16.0	24.5	8.0	6.390
SO 42521-12-3/8	018.2501.390	100	16x1.0	19	22	35.5	16.0	24.5	9.0	6.860
* SO 42521-12-1/2	018.2501.400	40	20x1.5	24	27	43.5	22.0	30.5	10.0	12.950
* SO 42521-13-1/2	018.2501.454	40	20x1.5	24	27	43.5	22.0	30.5	11.0	12.840
SO 42521-14-1/2	018.2501.504	40	20x1.5	24	27	43.5	22.0	30.5	12.0	12.730
SO 42521-15-1/2	018.2501.534	40	20x1.5	24	27	43.5	22.0	30.5	12.0	12.410
* SO 42521-15-3/4	018.2501.536	40	24x1.5	27	32	47.0	24.0	33.0	13.0	19.160
SO 42521-16-1/2	018.2501.566	40	24x1.5	27	27	45.0	24.0	31.0	14.0	16.350
SO 42521-16-3/4	018.2501.568	40	24x1.5	27	32	47.0	24.0	33.0	14.0	18.930
SO 42521-17-1/2	018.2501.596	40	24x1.5	27	27	45.0	22.0	31.0	15.0	16.100
SO 42521-17-3/4	018.2501.598	40	24x1.5	27	32	47.0	24.0	33.0	15.0	18.680
SO 42521-18-1/2	018.2501.646	40	24x1.5	27	27	45.0	22.0	31.0	13.0	15.830
SO 42521-18-3/4	018.2501.648	40	24x1.5	27	32	47.0	24.0	33.0	15.0	18.410
* SO 42521-19-3/4	018.2501.678	25	28x1.5	32	32	52.5	24.0	33.0	16.0	22.360
SO 42521-22-3/4	018.2501.768	25	28x1.5	32	32	52.5	24.0	33.0	19.0	20.960
Für Zollrohre	Pour tubes pouces	For inch tubes								
SO 42521-6,35-1/8	018.2501.135	250	10x1.0	12	14	27.5	11.5	20.0	4.0	2.590
SO 42521-9,52-3/8	018.2501.235	125	14x1.0	17	22	34.5	16.0	24.5	8.0	6.450
* SO 42521-12,7-1/2	018.2501.434	40	20x1.5	24	27	43.0	22.0	30.5	11.0	12.840

Umrechnung für "d" bei Zollrohren:

6,35 = 1/4
9,52 = 3/8
12,7 = 1/2

Conversion de "d" pour tubes en pouces:

6,35 = 1/4
9,52 = 3/8
12,7 = 1/2

Conversion for "d" for inch tubes:

6,35 = 1/4
9,52 = 3/8
12,7 = 1/2

d=Rohrassen-ø
e=kleinste Bohrung
L=Mass in montiertem Zustand
*=mit reduziertem Klemmring

d=ø extérieur du tube
e=ø-min. de passage
L=après montage
*=avec bague de serrage de réduction

d=tube outside diameter
e=minimum bore
L=installed length
*=with reduction compression ferrule

Einstellbare Winkelverschraubung
Coude orientable
Adjustable elbow union

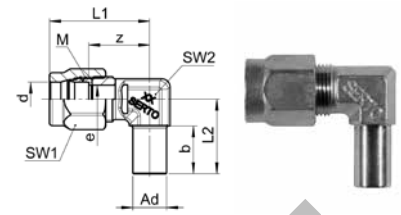

SO 42621

Type -d -Ad	Mat.-Nr.	bar	M	SW1	SW2	L1	L2	b	z	e	kg/100	
Für metrische Rohre	Pour tubes métriques			For metric tubes								
* SO 42621-4-A6	018.2600.045	100	10x1.0	12	10	23.5	17.5	11.0	16.0	3.4	1.980	
* SO 42621-5-A6	018.2600.053	100	10x1.0	12	10	23.5	17.5	11.0	16.0	4.0	1.930	
SO 42621-6-A6	018.2600.060	200	10x1.0	12	10	23.5	17.5	11.0	16.0	4.0	1.870	
* SO 42621-6-A8	018.2600.063	100	12x1.0	14	10	26.0	21.0	13.0	18.0	4.5	2.600	
SO 42621-8-A8	018.2600.080	100	12x1.0	14	10	26.0	21.0	13.0	18.0	6.0	2.460	
* SO 42621-8-A10	018.2600.083	80	14x1.0	17	14	30.5	26.0	16.5	20.5	8.0	4.180	
SO 42621-10-A10	018.2600.100	80	14x1.0	17	14	30.5	26.0	16.5	20.5	8.0	3.990	
* SO 42621-10-A12	018.2600.103	60	16x1.0	19	17	33.5	26.5	17.0	21.5	8.5	5.780	
SO 42621-12-A12	018.2600.120	60	16x1.0	19	17	33.5	26.5	17.0	21.5	9.0	5.500	
* SO 42621-13-A15	018.2600.135	40	20x1.5	24	19	36.0	29.0	18.0	23.5	11.0	8.980	
SO 42621-14-A15	018.2600.143	40	20x1.5	24	19	36.0	29.0	18.0	23.5	12.0	8.870	
SO 42621-15-A15	018.2600.150	40	20x1.5	24	19	36.0	29.0	18.0	23.5	12.0	8.550	
* SO 42621-15-A18	018.2600.156	40	24x1.5	27	22	40.5	35.0	20.0	26.5	13.0	13.280	
SO 42621-16-A18	018.2600.165	40	24x1.5	27	22	40.5	35.0	20.0	26.5	14.0	13.050	
SO 42621-17-A18	018.2600.173	40	24x1.5	27	22	40.5	35.0	20.0	26.5	15.0	12.800	
SO 42621-18-A18	018.2600.180	40	24x1.5	27	22	40.5	35.0	20.0	26.5	15.0	12.530	
* SO 42621-19-A22	018.2600.195	25	28x1.5	32	27	48.0	36.0	21.0	30.5	16.0	17.850	
SO 42621-22-A22	018.2600.220	25	28x1.5	32	27	48.0	36.0	21.0	30.5	19.0	16.750	
SO 42621-28-A28	018.2600.280	16	36x2.0	41	32	58.5	42.0	24.0	39.0	24.0	33.000	
SO 42621-35-A35	018.2600.350	16	42x2.0	50	41	67.0	48.5	26.0	45.0	30.0	56.600	

Für Zollrohre	Pour tubes pouces			For inch tubes								
SO 42621-6,35-A6	018.2600.067	200	10x1.0	12	10	23.5	17.5	11.0	16.0	4.0	1.870	
SO 42621-9,52-A10	018.2600.090	80	14x1.0	17	14	30.5	26.0	16.5	20.5	8.0	3.050	
* SO 42621-12,7-A15	018.2600.125	40	20x1.5	24	19	36.0	29.0	18.0	23.5	11.0	8.980	
SO 42621-15,88-A18	018.2600.163	40	24x1.5	27	22	40.5	35.0	20.0	26.5	14.0	13.050	

Umrechnung für "d" bei Zollrohren:
 6,35 = 1/4
 9,52 = 3/8
 12,7 = 1/2
 15,88 = 5/8

Conversion de "d" pour tubes en pouces:
 6,35 = 1/4
 9,52 = 3/8
 12,7 = 1/2
 15,88 = 5/8

Conversion for "d" for inch tubes:
 6,35 = 1/4
 9,52 = 3/8
 12,7 = 1/2
 15,88 = 5/8

Fortsetzung nächste Seite

Suite à la prochaine page

Continued on next page

d=Rohrassens-ø
 Ad=Aussen-ø der Andrehung
 e=kleinste Bohrung
 L=Mass in montiertem Zustand
 *=mit reduziertem Klemmring

d=ø extérieur du tube
 Ad=ø extérieur de la portée cylindrique
 e=ø-min. de passage
 L=après montage
 *=avec bague de serrage de réduction

d=tube outside diameter
 Ad=outside diameter of cyl. stub
 e=minimum bore
 L=installed length
 *=with reduction compression ferrule

Anwendungsbeispiele:

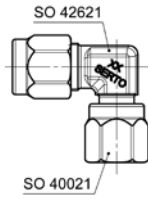

Mögliche Kombinationen:

- mit Armaturenanschluss zu einstellbaren Winkelverschraubungen
- mit Verschraubungen zu einstellbaren Verschraubungen
- mit Einschraubverschraubungen zu einstellbaren Einschraubwinkeln. Gegenüber dem Einschraubwinkel lässt sich diese Kombination einfacher einstellen, da Einschrauben und Ausrichten getrennt voneinander vorgenommen werden.

Exemples d'utilisation:

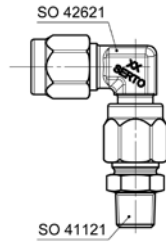

Combinaisons possibles:

- avec écrou de raccordement ça donne des raccords coudé orientables
- avec raccords ça donne des raccords orientables
- avec une union mâle ça donne un coude fileté orientable. Par rapport au coude orientable, cette combinaison est facile à régler, puisque le vissage et l'alignement sont réalisés séparément l'un de l'autre.

Sample combinations:

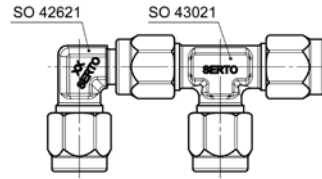

Possible combinations:

- with a nut connection to adjustable elbow unions
- with a union to adjustable unions
- with a male adaptor union to adjustable male adaptor elbow unions. This combination is simpler to produce, as screwing in and alignment are carried out separately.

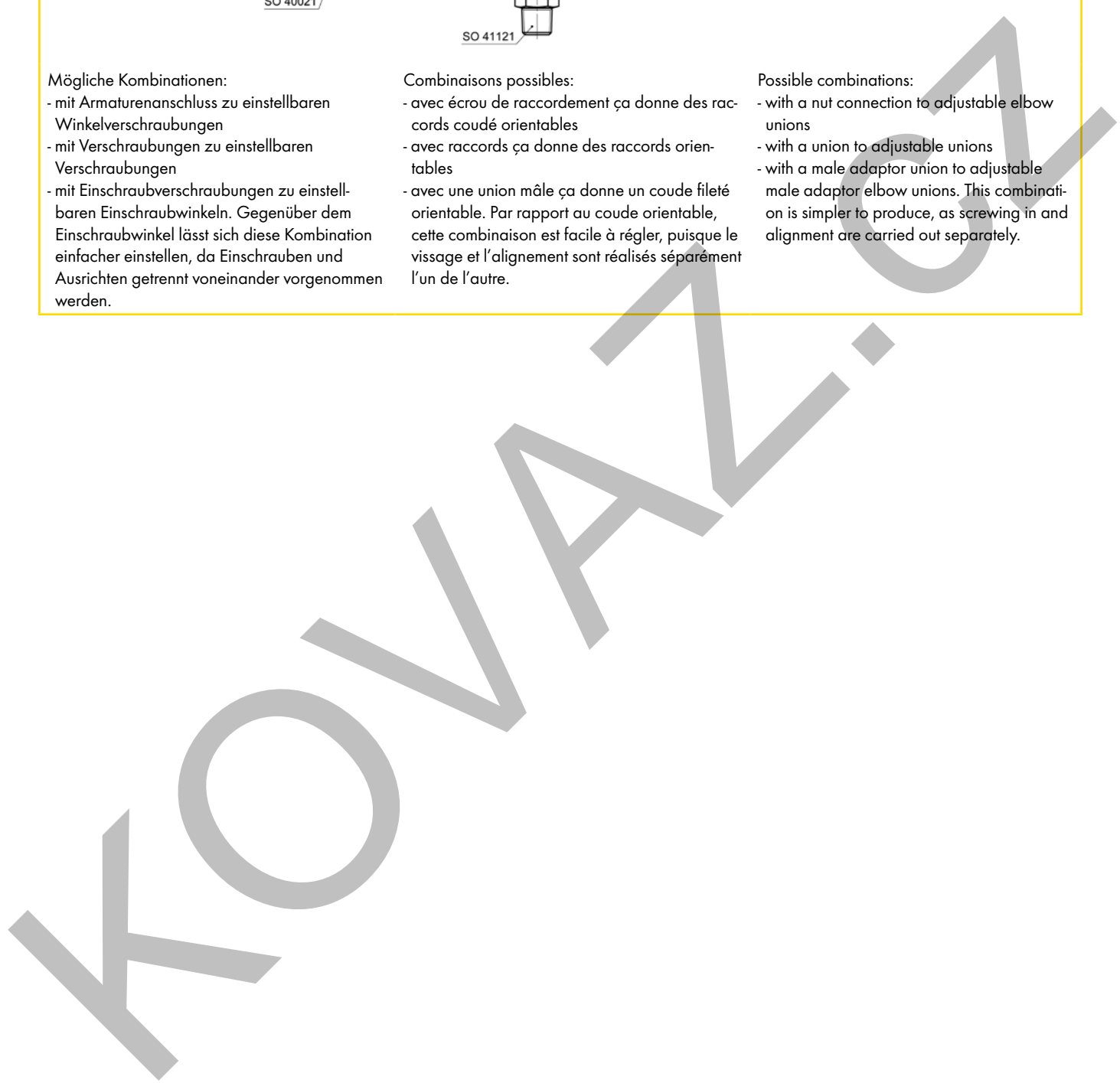

d=Rohraussen-ø
 Ad=Aussen-ø der Andrehung
 e=kleinste Bohrung
 L=Mass in montiertem Zustand
 *=mit reduziertem Klemmring

d=ø extérieur du tube
 Ad=ø extérieur de la portée cylindrique
 e=ø-min. de passage
 L=après montage
 *=avec bague de serrage de réduction

d=tube outside diameter
 Ad=outside diameter of cyl. stub
 e=minimum bore
 L=installed length
 *=with reduction compression ferrule

Einstellbare Winkelverschraubung vormontiert
Coude orientable prémonté
Adjustable elbow union pre-assembled

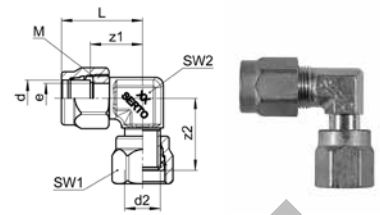

SO 42625

Type -d -d2	Mat.-Nr.	bar	M	SW1	SW2	L	z1	z2	e	kg/100	
Für metrische Rohre	Pour tubes métriques			For metric tubes							
* SO 42625-4-A6	018.2620.045	100	10x1.0	12	10	23.5	16.0	18.5	3.4	2.820	
* SO 42625-5-A6	018.2620.053	100	10x1.0	12	10	23.5	16.0	18.5	4.0	2.770	
SO 42625-6-A6	018.2620.060	200	10x1.0	12	10	23.5	16.0	18.5	4.0	2.710	
* SO 42625-6-A8	018.2620.063	100	12x1.0	14	11	26.0	18.0	22.0	4.5	3.000	
SO 42625-8-A8	018.2620.080	100	12x1.0	14	11	26.0	18.0	22.0	6.0	3.580	
* SO 42625-8-A10	018.2620.083	80	14x1.0	17	14	30.5	20.5	27.0	8.0	6.070	
SO 42625-10-A10	018.2620.100	80	14x1.0	17	14	30.5	20.5	27.0	8.0	5.880	
* SO 42625-10-A12	018.2620.103	60	16x1.0	19	17	33.5	21.5	27.5	8.5	8.000	
SO 42625-12-A12	018.2620.120	60	16x1.0	19	17	33.5	21.5	27.5	9.0	7.840	
* SO 42625-13-A15	018.2620.135	40	20x1.5	24	19	36.0	23.5	30.0	11.0	13.000	
SO 42625-14-A15	018.2620.143	40	20x1.5	24	19	36.0	23.5	30.0	12.0	13.000	
SO 42625-15-A15	018.2620.150	40	20x1.5	24	19	36.0	23.5	30.0	12.0	12.790	
* SO 42625-15-A18	018.2620.156	40	24x1.5	27	22	40.5	26.5	36.5	13.0	18.000	
SO 42625-16-A18	018.2620.165	40	24x1.5	27	22	40.5	26.5	36.5	14.0	18.000	
SO 42625-17-A18	018.2620.173	40	24x1.5	27	22	40.5	26.5	36.5	15.0	18.000	
SO 42625-18-A18	018.2620.180	40	24x1.5	27	22	40.5	26.5	36.5	15.0	17.790	
* SO 42625-19-A22	018.2620.195	25	28x1.5	32	27	48.0	30.5	37.5	16.0	26.000	
SO 42625-22-A22	018.2620.220	25	28x1.5	32	27	48.0	30.5	37.5	19.0	25.170	
SO 42625-28-A28	018.2620.280	16	36x2.0	41	32	58.5	39.0	44.0	24.0	49.700	
SO 42625-35-A35	018.2620.350	16	42x2.0	50	41	67.0	45.0	50.5	30.0	85.800	
Für Zollrohre	Pour tubes pouces			For inch tubes							
SO 42625-6,35-A6	018.2620.067	200	10x1.0	12	10	23.5	16.0	18.5	4.0	2.000	
SO 42625-9,52-A10	018.2620.090	80	14x1.0	17	14	30.5	20.5	27.0	8.0	5.000	
SO 42625-12,7-A15	018.2620.125	40	20x1.5	24	19	36.0	23.5	30.0	11.0	7.000	
SO 42625-15,88-A18	018.2620.163	40	24x1.5	27	22	40.5	26.5	36.5	14.0	18.000	

Umrechnung für "d" bei Zollrohren:

- 6,35 = 1/4
- 9,52 = 3/8
- 12,7 = 1/2
- 15,88 = 5/8

Conversion de "d" pour tubes en pouces:

- 6,35 = 1/4
- 9,52 = 3/8
- 12,7 = 1/2
- 15,88 = 5/8

Conversion for "d" for inch tubes:

- 6,35 = 1/4
- 9,52 = 3/8
- 12,7 = 1/2
- 15,88 = 5/8

Montagehinweis: Anschlussmutter auf Seite Einstellteil mit 1/4 Umdrehung anziehen. Wir empfehlen eine zusätzliche Schmierung auf der Planfläche.

Note d'installation: Serrez l'écrou du côté orientable de 1/4 de tour. Nous recommandons une lubrification supplémentaire sur la surface plane.

Assembly information: Tighten the union nut on the adjustable side with 1/4 turn. We recommend additional lubrication on the plane surface.

d=Rohrassen-ø
 e=kleinste Bohrung
 L=Mass in montiertem Zustand
 *=mit reduziertem Klemmring

d=ø extérieur du tube
 e=ø-min. de passage
 L=après montage
 *=avec bague de serrage de réduction

d=tube outside diameter
 e=minimum bore
 L=installed length
 *=with reduction compression ferrule

Winkel-Schottverschraubung

Durchführungslänge max. 5 mm

Coude traversée de cloison

pour cloison max. 5 mm

Panel mount elbow union

max. panel thickness 5 mm

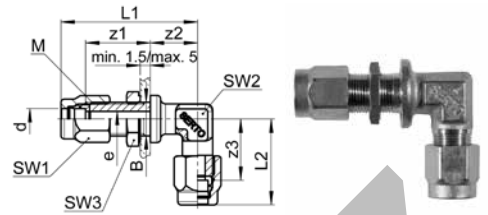

SO 42721

Type-d	Mat.-Nr.	bar	M	SW1	SW2	SW3	L1	L2	B	z1	z2	z3	e	kg/100
Für metrische Rohre			Pour tubes métriques											
														For metric tubes
* SO 42721-4	018.2700.040	100	10x1.0	12	10	14	40.5	25.5	10.5	19.0	14.0	18.0	3.4	4.270
* SO 42721-5	018.2700.050	100	10x1.0	12	10	14	40.5	25.5	10.5	19.0	14.0	18.0	4.0	4.220
SO 42721-6	018.2700.060	250	10x1.0	12	10	14	40.5	25.5	10.5	19.0	14.0	18.0	4.0	4.160
SO 42721-8	018.2700.080	150	12x1.0	14	11	17	45.0	28.5	12.5	20.0	17.0	20.5	6.0	6.480
SO 42721-10	018.2700.100	125	14x1.0	17	17	19	49.0	33.5	14.5	21.0	18.0	23.5	8.0	9.560
SO 42721-12	018.2700.120	100	16x1.0	19	17	19	50.0	34.5	16.5	21.0	18.0	23.5	10.0	10.640
* SO 42721-13	018.2700.130	40	20x1.5	24	19	27	57.0	38.0	20.5	24.5	20.0	25.5	11.0	18.730
SO 42721-14	018.2700.140	40	20x1.5	24	19	27	57.0	38.0	20.5	24.5	20.0	25.5	12.0	18.940
SO 42721-15	018.2700.150	40	20x1.5	24	19	27	57.0	38.0	20.5	24.5	20.0	25.5	13.0	18.300
Für Zollrohre			Pour tubes pouces											For inch tubes
SO 42721-6,35	018.2700.063	250	10x1.0	12	10	14	40.5	25.5	10.5	19.0	14.0	18.0	4.0	4.130
SO 42721-9,52	018.2700.095	125	14x1.0	17	17	19	49.0	33.5	14.5	21.0	18.0	23.5	8.0	9.680
* SO 42721-12,7	018.2700.127	40	20x1.5	24	19	27	57.0	38.0	20.5	24.5	20.0	25.5	11.0	18.730

Umrechnung für "d" bei Zollrohren:

6,35 = 1/4
9,52 = 3/8
12,7 = 1/2

Conversion de "d" pour tubes en pouces:

6,35 = 1/4
9,52 = 3/8
12,7 = 1/2

Conversion for "d" for inch tubes:

6,35 = 1/4
9,52 = 3/8
12,7 = 1/2

Sechskantmutter siehe SO 40006 METR

Ecrou à six pans voir SO 40006 METR

Hexagon nut see SO 40006 METR

d=Rohrassen-ø
e=kleinste Bohrung
L=Mass in montiertem Zustand
*=mit reduziertem Klemmring

d=ø extérieur du tube
e=ø-min. de passage
L=après montage
*=avec bague de serrage de réduction

d=tube outside diameter
e=minimum bore
L=installed length
*=with reduction compression ferrule

Winkel-Schottverschraubung reduziert

Durchführungslänge max. 5 mm

Coude réduit traversée de cloison

pour cloison max. 5 mm

Panel mount reduction elbow union

Max. panel thickness 5 mm

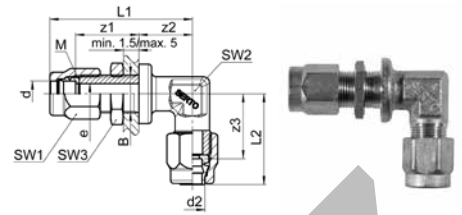

SO 42721 RED

Type -d -d2	Mat.-Nr.	bar	M	SW1	SW2	SW3	L1	L2	B	z1	z2	z3	e	kg/100
Für metrische Rohre			Pour tubes métriques							For metric tubes				
* SO 42721-6-4	018.2704.110	100	10x1.0	12	10	14	40.5	25.5	10.5	19.0	14.0	18.0	3.4	4.250
* SO 42721-6-5	018.2704.117	100	10x1.0	12	10	14	40.5	25.5	10.5	19.0	14.0	18.0	4.0	4.220
* SO 42721-8-6	018.2704.140	250	12x1.0	14	11	17	45.0	28.5	12.5	20.0	17.0	20.5	4.5	6.640
* SO 42721-10-8	018.2704.190	150	14x1.0	17	17	19	49.0	33.5	14.5	21.0	18.0	23.5	6.5	9.570
* SO 42721-12-10	018.2704.240	100	16x1.0	19	17	19	50.0	34.5	16.5	21.0	18.0	23.5	8.5	10.920
* SO 42721-15-12	018.2704.420	40	20x1.5	24	19	27	57.0	38.0	20.5	24.5	20.0	25.5	10.0	18.840
* SO 42721-15-13	018.2704.430	40	20x1.5	24	19	27	57.0	38.0	20.5	24.5	20.0	25.5	11.0	18.730
SO 42721-15-14	018.2704.440	40	20x1.5	24	19	27	57.0	38.0	20.5	24.5	20.0	25.5	12.0	18.620
Für Zollrohre			Pour tubes pouces							For inch tubes				
SO 42721-6-6,35	018.2704.119	250	10x1.0	12	10	14	40.5	25.5	10.5	19.0	14.0	18.0	4.0	4.150
SO 42721-10-9,52	018.2704.197	125	14x1.0	17	17	19	49.0	33.5	14.5	21.0	18.0	23.5	8.0	9.620
* SO 42721-15-12,7	018.2704.427	40	20x1.5	24	19	27	57.0	38.0	20.5	24.5	20.0	25.5	11.0	18.730

Umrechnung für "d" bei Zollrohren:

6,35 = 1/4
9,52 = 3/8
12,7 = 1/2

Conversion de "d" pour tubes en pouces:

6,35 = 1/4
9,52 = 3/8
12,7 = 1/2

Conversion for "d" for inch tubes:

6,35 = 1/4
9,52 = 3/8
12,7 = 1/2

Sechskantmutter siehe SO 40006 METR

Ecrou à six pans voir SO 40006 METR

Hexagon nut see SO 40006 METR

d=Rohrassen-ø
e=kleinste Bohrung
L=Mass in montiertem Zustand
*=mit reduziertem Klemmring

d=ø extérieur du tube
e=ø-min. de passage
L=après montage
*=avec bague de serrage de réduction

d=tube outside diameter
e=minimum bore
L=installed length
*=with reduction compression ferrule

Schwenkverschraubung
Coude banjo
Single banjo

SO 42824

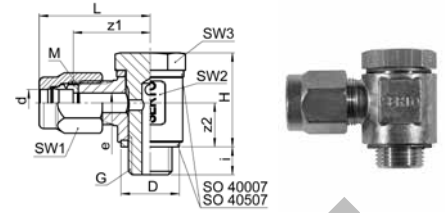

Type -d-G	Mat.-Nr.	bar	M	SW1	SW2	SW3	L	D	H	i	z1	z2	e	kg/100
Für metrische Rohre G=Rohrgewinde (zylindrisch)														

Für Zollrohre														

Umrechnung für "d" bei Zollrohren:
3,2 = 1/8
6,35 = 1/4
9,52 = 3/8
12,7 = 1/2

Conversion de "d" pour tubes en pouces:
3,2 = 1/8
6,35 = 1/4
9,52 = 3/8
12,7 = 1/2

Conversion for "d" for inch tubes:
3,2 = 1/8
6,35 = 1/4
9,52 = 3/8
12,7 = 1/2

Dichtungen werden mitgeliefert.
Ersatzdichtungen siehe SO 40007 / SO 40507.

Les joints sont fournis.
Joints de rechange voir SO 40007 / SO 40507.

The washers are included.
Replacement washers see SO 40007 / SO 40507.

Schwenkverschraubung mit Drossel- bzw. Drosselrückschlagventil siehe SO 47624 und SO 47724.

Coude banjo avec limiteur de débit ou clapet anti-retour limiteur de débit voir SO 47624 et SO 47724.

Single banjo with throttle valve or non-return throttle valve see SO 47624 and SO 47724.

Sicherheitsfaktor Betriebsdruck (PN): 1.5-fach

Facteur de sécurité pression de service (PN): 1.5 fois

Safety factor working pressure (PN): 1.5 times

d=Rohrassens-ø
e=kleinste Bohrung
L=Mass in montiertem Zustand
*=mit reduziertem Klemmring

d=ø extérieur du tube
e=ø-min. de passage
L=après montage
*=avec bague de serrage de réduction

d=tube outside diameter
e=minimum bore
L=installed length
*=with reduction compression ferrule

Schwenkverschraubung METR
Coude banjo METR
Single banjo METR

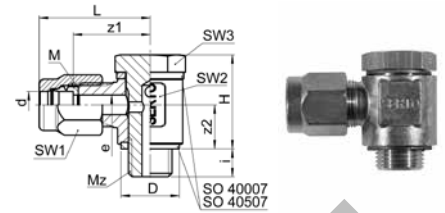

SO 42824 METR

Type -d -Mz	Mat.-Nr.	bar	M	SW1	SW2	SW3	L	D	H	i	z1	z2	e	kg/100
Für metrische Rohre														
Mz=metrisches Gewinde (zylindrisch)														
Pour tubes métriques														
Mz=Filetage métrique (cylindrique)														
For metric tubes														
Mz=Metric thread (parallel)														
* SO 42824-3-M5	018.2843.050	125	8x1.0	10	12	8	20.0	9.0	17.5	4.0	13.5	6.8	2.2	1.150
* SO 42824-3-M10x1	018.2843.065	125	8x1.0	10	14	14	24.0	15.0	21.5	6.5	17.5	10.5	2.5	6.410
SO 42824-4-M5	018.2843.080	125	8x1.0	10	12	8	19.5	9.0	17.5	4.0	13.5	6.8	2.2	1.480
SO 42824-4-M10x1	018.2843.096	125	8x1.0	10	14	14	24.0	15.0	21.5	6.5	17.5	10.5	3.4	6.360
SO 42824-5-M5	018.2843.110	125	8x1.0	10	12	8	20.0	9.0	17.5	4.0	13.5	6.8	2.2	1.470
SO 42824-5-M10x1	018.2843.135	125	8x1.0	10	14	14	24.0	15.0	21.5	6.5	17.5	10.5	3.8	6.350
SO 42824-6-M10x1	018.2843.180	250	10x1.0	12	14	14	25.0	15.0	21.5	6.5	17.5	10.5	3.8	4.010
* SO 42824-6-M12x1,5	018.2843.195	250	12x1.0	14	19	19	29.5	20.0	28.5	7.0	21.5	13.0	4.5	8.150
* SO 42824-6-M14x1,5	018.2843.198	250	12x1.0	14	19	19	29.5	20.0	29.0	7.0	21.5	13.0	4.5	8.110
SO 42824-8-M10x1	018.2843.230	150	12x1.0	14	14	14	25.5	15.0	21.5	6.5	17.5	10.0	3.8	4.310
SO 42824-8-M12x1,5	018.2843.240	150	12x1.0	14	19	19	29.5	20.0	29.0	7.0	21.5	13.0	6.0	7.990
SO 42824-8-M14x1,5	018.2843.245	150	12x1.0	14	19	19	29.5	20.0	29.0	7.0	21.5	13.0	6.0	7.950
SO 42824-10-M12x1,5	018.2843.275	150	14x1.0	17	19	19	31.5	20.0	29.0	7.0	21.5	13.5	6.5	8.720
SO 42824-10-M14x1,5	018.2843.280	150	14x1.0	17	19	19	31.5	20.0	29.0	7.0	21.5	13.5	6.5	8.680
Für Zollrohre														
Pour tubes pouces														
For inch tubes														
SO 42824-6,35-M10x1	018.2843.210	250	10x1.0	12	14	14	25.0	15.0	21.5	6.5	17.5	10.5	3.8	4.000
SO 42824-9,52-M12x1,5	018.2843.261	125	14x1.0	17	19	19	31.5	20.0	29.0	7.0	21.5	13.5	6.5	8.780
SO 42824-9,52-M14x1,5	018.2843.265	125	14x1.0	17	19	19	31.5	20.0	29.0	7.0	21.5	13.5	6.5	8.740

Umrechnung für "d" bei Zollrohren:
 6,35 = 1/4
 9,52 = 3/8

Conversion de "d" pour tubes en pouces:
 6,35 = 1/4
 9,52 = 3/8

Conversion for "d" for inch tubes:
 6,35 = 1/4
 9,52 = 3/8

Dichtungen werden mitgeliefert.
 Ersatzdichtungen siehe SO 40007 /
 SO 40507.

Les joints sont fournis.
 Joints de rechange voir SO 40007 /
 SO 40507.

The washers are included.
 Replacement washers see SO 40007 /
 SO 40507.

Schwenkverschraubung mit Drossel- bzw.
 Drosselrückschlagventil siehe SO 47624 und
 SO 47724.

Coude banjo avec limiteur de débit ou clapet
 anti-retour limiteur de débit voir SO 47624 et
 SO 47724.

Single banjo with throttle valve or non-return
 throttle valve see SO 47624 and SO 47724.

Sicherheitsfaktor Betriebsdruck (PN): 1.5-fach

Facteur de sécurité pression de service (PN):
 1.5 fois

Safety factor working pressure (PN): 1.5 times

d=Rohrassen-ø
 e=kleinste Bohrung
 L=Mass in montiertem Zustand
 *=mit reduziertem Klemmring

d=ø extérieur du tube
 e=ø-min. de passage
 L=après montage
 *=avec bague de serrage de réduction

d=tube outside diameter
 e=minimum bore
 L=installed length
 *=with reduction compression ferrule

2-fach Winkel-Schwenkverschraubung Coude banjo double Double banjo

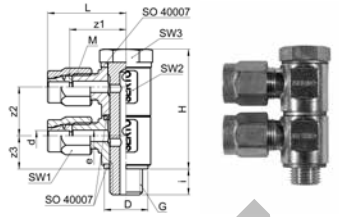

SO 42924

Type - n x d - G	Mat.-Nr.	bar	M	SW1	SW2	SW3	L	D	H	i	z1	z2	z3	e	kg/100
Für metrische Rohre G=Rohrgewinde (zylindrisch)															
★ SO 42924-2x3-1/8	018.2941.040	125	8x1.0	10	14	14	24.0	15.0	37.0	8.0	17.5	16.0	10.0	2.5	6.300
SO 42924-2x4-1/8	018.2941.060	125	8x1.0	10	14	14	23.5	15.0	37.0	8.0	17.5	16.0	10.0	3.4	6.190
SO 42924-2x5-1/8	018.2941.082	125	8x1.0	10	14	14	24.0	15.0	37.0	8.0	17.5	16.0	10.0	3.5	6.170
SO 42924-2x6-1/8	018.2941.100	250	10x1.0	12	14	14	25.0	15.0	37.0	8.0	17.5	16.0	10.0	3.8	7.000
★ SO 42924-2x6-1/4	018.2941.110	250	12x1.0	14	19	19	29.0	20.0	49.0	9.0	21.0	22.0	14.0	4.5	14.110
SO 42924-2x8-1/8	018.2941.160	150	12x1.0	14	14	14	25.5	15.0	37.0	8.0	17.5	16.0	10.0	3.8	7.790
SO 42924-2x8-1/4	018.2941.170	150	12x1.0	14	19	19	29.0	20.0	49.0	9.0	21.0	22.0	14.0	6.0	13.790
SO 42924-2x10-1/4	018.2941.270	125	14x1.0	17	19	19	31.0	20.0	49.0	9.0	21.0	22.0	14.0	6.5	14.990
Für Zollrohre															
SO 42924-2x6,35-1/8	018.2941.135	250	10x1.0	12	14	14	25.0	15.0	37.0	8.0	17.5	16.0	10.0	3.8	7.000
SO 42924-2x9,52-1/4	018.2941.230	125	14x1.0	17	19	19	31.0	20.0	49.0	9.0	21.0	22.0	14.0	6.5	15.110

Umrechnung für "d" bei Zollrohren:

6,35 = 1/4
9,52 = 3/8

Conversion de "d" pour tubes en pouces:

6,35 = 1/4
9,52 = 3/8

Conversion for "d" for inch tubes:

6,35 = 1/4
9,52 = 3/8

Dichtungen werden mitgeliefert.
Ersatzdichtungen siehe SO 40007.

Les joints sont fournis.
Joints de rechange voir SO 40007.

The washers are included.
Replacement washers see SO 40007.

Scherheitsfaktor Betriebsdruck (PN): 1.5-fach

Facteur de sécurité pression de service (PN):
1.5 fois

Safety factor working pressure (PN): 1.5 times

n=Anzahl Schwenkkörper
d=Rohraussen-ø
e=kleinste Bohrung
L=Mass in montiertem Zustand
*=mit reduziertem Klemmring

n=nombre d'éléments orientables
d=ø extérieur du tube
e=ø-min. de passage
L=après montage
*=avec bague de serrage de réduction

n=number of swivel bodies
d=tube outside diameter
e=minimum bore
L=installed length
*=with reduction compression ferrule

T-Verschraubung

Té égal

Tee union

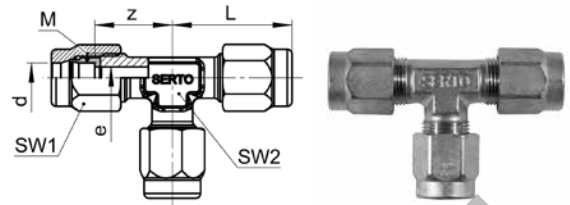

SO 43021

Type-d	Mat.-Nr.	bar	M	SW1	SW2	L	z	e	kg/100
Für metrische Rohre	Pour tubes métriques			For metric tubes					
SO 43021-2	018.3000.020	125	6x0.75	8	7	16.5	12.5	1.5	1.480
SO 43021-3	018.3000.030	125	6x0.75	8	7	18.0	13.0	2.5	1.500
SO 43021-4	018.3000.040	125	8x1.0	10	10	22.0	16.0	3.4	2.670
SO 43021-5	018.3000.050	125	8x1.0	10	10	22.5	16.0	4.0	2.630
SO 43021-6	018.3000.060	250	10x1.0	12	10	23.5	16.0	4.0	4.240
SO 43021-8	018.3000.080	150	12x1.0	14	10	26.0	18.0	6.0	5.590
SO 43021-10	018.3000.100	125	14x1.0	17	14	30.5	20.5	8.0	8.840
SO 43021-12	018.3000.120	100	16x1.0	19	17	32.5	21.5	10.0	11.320
* SO 43021-13	018.3000.130	40	20x1.5	24	19	36.0	23.5	11.0	19.180
SO 43021-14	018.3000.140	40	20x1.5	24	19	36.0	23.5	12.0	19.710
SO 43021-15	018.3000.150	40	20x1.5	24	19	36.0	23.5	12.0	18.750
SO 43021-16	018.3000.160	40	24x1.5	27	22	40.5	26.5	14.0	27.160
SO 43021-17	018.3000.170	40	24x1.5	27	22	40.5	26.5	15.0	26.400
SO 43021-18	018.3000.180	40	24x1.5	27	22	40.5	26.5	15.0	25.600
* SO 43021-19	018.3000.190	25	28x1.5	32	27	48.0	30.5	16.0	41.400
SO 43021-22	018.3000.220	25	28x1.5	32	27	48.0	30.5	19.0	37.350
SO 43021-28	018.3000.280	16	36x2.0	41	32	58.5	39.0	24.0	44.500
SO 43021-35	018.3000.350	16	42x2.0	50	41	67.0	45.0	31.0	135.500
Für Zollrohre	Pour tubes pouces			For inch tubes					
* SO 43021-3,2	018.3000.032	125	8x1.0	10	10	22.0	16.0	2.5	2.700
SO 43021-6,35	018.3000.063	250	10x1.0	12	10	23.5	16.0	4.0	4.200
SO 43021-9,52	018.3000.095	125	14x1.0	17	14	30.5	20.5	8.0	9.020
* SO 43021-12,7	018.3000.127	40	20x1.5	24	19	36.0	23.5	11.0	19.180
SO 43021-15,88	018.3000.158	40	24x1.5	27	22	40.5	26.5	14.0	27.160
SO 43021-22,22	018.3000.222	25	28x1.5	32	27	48.0	30.5	19.0	37.350

Umrechnung für "d" bei Zollrohren:

- 3,2 = 1/8
- 6,35 = 1/4
- 9,52 = 3/8
- 12,7 = 1/2
- 15,88 = 5/8
- 22,22 = 7/8

Conversion for "d" for inch tubes:

- 3,2 = 1/8
- 6,35 = 1/4
- 9,52 = 3/8
- 12,7 = 1/2
- 15,88 = 5/8
- 22,22 = 7/8

Conversion de "d" pour tubes en pouces:

- 3,2 = 1/8
- 6,35 = 1/4
- 9,52 = 3/8
- 12,7 = 1/2
- 15,88 = 5/8
- 22,22 = 7/8

d=Rohrassen-ø
 e=kleinste Bohrung
 L=Mass in montiertem Zustand
 *=mit reduziertem Klemmring

d=ø extérieur du tube
 e=ø-min. de passage
 L=après montage
 *=avec bague de serrage de réduction

d=tube outside diameter
 e=minimum bore
 L=installed length
 *=with reduction compression ferrule

T-Verschraubung reduziert
Té réduit
Tee reduction union

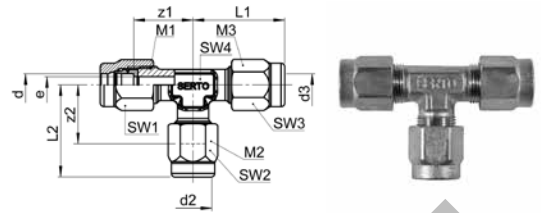

SO 43021 RED

Type -d -d2 -d3	Mat.-Nr.	bar	M1	M2	M3	SW1	SW2	SW3	SW4	L1	L2	z1	z2	e	Vers.	kg/100	
Für metrische Rohre			Pour tubes métriques								For metric tubes						
* SO 43021-5-3-3	018.3004.030	125	8x1.0	8x1.0	8x1.0	10	10	10	10	22.5	22.5	16.0	16.0	2.5	V0	2.750	
* SO 43021-5-3-5	018.3004.034	125	8x1.0	8x1.0	8x1.0	10	10	10	10	22.5	22.5	16.0	16.0	2.5	V0	2.690	
* SO 43021-6-4-4	018.3004.046	100	10x1.0	10x1.0	10x1.0	12	12	12	10	23.5	23.5	16.0	16.0	3.4	V0	4.460	
* SO 43021-6-4-6	018.3004.049	100	10x1.0	10x1.0	10x1.0	12	12	12	10	23.5	23.5	16.0	16.0	3.4	V0	4.350	
* SO 43021-6-8-6	018.3004.058	150	12x1.0	12x1.0	12x1.0	14	14	14	12	26.0	26.0	18.0	18.0	4.5	V0	5.910	
SO 43021-6-10-6	018.3004.062	125	10x1.0	14x1.0	10x1.0	12	17	12	14	30.5	26.5	20.5	20.5	4.0	V2	7.440	
* SO 43021-8-6-6	018.3004.091	150	12x1.0	12x1.0	12x1.0	14	14	14	10	26.0	26.0	18.0	18.0	4.5	V0	5.910	
* SO 43021-8-6-8	018.3004.093	150	12x1.0	12x1.0	12x1.0	14	14	14	10	26.0	26.0	18.0	18.0	4.5	V0	5.750	
* SO 43021-8-10-8	018.3004.104	125	14x1.0	14x1.0	14x1.0	17	17	17	14	30.5	30.5	20.5	20.5	6.5	V0	9.240	
SO 43021-10-6-6	018.3004.143	125	14x1.0	10x1.0	10x1.0	17	12	12	14	30.5	26.5	20.5	20.5	4.0	V4	7.440	
SO 43021-10-6-10	018.3004.147	125	14x1.0	10x1.0	14x1.0	17	12	17	14	30.5	26.5	20.5	20.5	4.0	V3	8.600	
* SO 43021-10-8-10	018.3004.153	125	14x1.0	14x1.0	14x1.0	17	17	17	14	30.5	30.5	20.5	20.5	6.5	V0	9.040	
* SO 43021-10-10-8	018.3004.161	125	14x1.0	14x1.0	14x1.0	17	17	17	14	30.5	30.5	20.5	20.5	6.5	V0	9.040	
* SO 43021-10-12-10	018.3004.165	100	16x1.0	16x1.0	16x1.0	19	19	19	17	32.5	32.5	21.5	21.5	8.5	V0	11.880	
* SO 43021-12-6-12	018.3004.200	100	16x1.0	12x1.0	16x1.0	19	14	19	17	32.5	27.5	21.5	21.5	4.5	V3	10.710	
SO 43021-12-8-12	018.3004.210	100	16x1.0	12x1.0	16x1.0	19	14	19	17	32.5	29.0	21.5	21.5	6.0	V3	10.540	
* SO 43021-12-10-10	018.3004.220	100	16x1.0	16x1.0	16x1.0	19	19	19	17	32.5	32.5	21.5	21.5	8.5	V0	11.880	
* SO 43021-12-12-10	018.3004.232	100	16x1.0	16x1.0	16x1.0	19	19	19	17	32.5	32.5	21.5	21.5	8.5	V0	11.600	
* SO 43021-12-14-12	018.3004.246	40	20x1.5	20x1.5	20x1.5	24	24	24	19	36.0	36.0	23.5	23.5	10.0	V0	20.470	
* SO 43021-12-15-12	018.3004.254	40	20x1.5	20x1.5	20x1.5	24	24	24	19	36.0	36.0	23.5	23.5	10.0	V0	19.830	
SO 43021-14-10-10	018.3004.328	40	20x1.5	14x1.0	14x1.0	24	17	17	19	36.0	33.5	23.5	23.5	8.0	V4	14.160	
* SO 43021-14-10-12	018.3004.330	40	20x1.5	14x1.0	20x1.5	24	17	24	19	36.0	34.5	23.5	23.5	8.0	V3	18.220	
SO 43021-14-10-14	018.3004.334	40	20x1.5	14x1.0	20x1.5	24	17	24	19	36.0	33.5	23.5	23.5	8.0	V3	17.660	
* SO 43021-14-12-12	018.3004.342	40	20x1.5	20x1.5	20x1.5	24	24	24	19	36.0	36.0	23.5	23.5	10.0	V0	20.470	
* SO 43021-14-12-14	018.3004.346	40	20x1.5	20x1.5	20x1.5	24	24	24	19	36.0	36.0	23.5	23.5	10.0	V0	20.090	
SO 43021-14-14-10	018.3004.359	40	20x1.5	20x1.5	14x1.0	24	24	17	19	36.0	36.0	23.5	23.5	8.0	V1	16.760	
* SO 43021-14-14-12	018.3004.361	40	20x1.5	20x1.5	20x1.5	24	24	24	19	36.0	36.0	23.5	23.5	10.0	V0	20.090	
* SO 43021-14-17-14	018.3004.375	40	24x1.5	24x1.5	24x1.5	27	27	27	22	40.5	40.5	23.5	23.5	12.0	V0	27.820	
SO 43021-15-10-10	018.3004.403	40	20x1.5	14x1.0	14x1.0	24	17	17	19	36.0	33.5	23.5	23.5	8.0	V4	13.770	
* SO 43021-15-10-12	018.3004.405	40	20x1.5	14x1.0	20x1.5	24	17	24	19	36.0	33.5	23.5	23.5	8.0	V3	17.800	
SO 43021-15-10-15	018.3004.410	40	20x1.5	14x1.0	20x1.5	24	17	24	19	36.0	33.5	23.5	23.5	8.0	V3	17.300	
* SO 43021-15-12-12	018.3004.417	40	20x1.5	20x1.5	20x1.5	24	24	24	19	36.0	36.0	23.5	23.5	10.0	V0	19.830	
* SO 43021-15-12-15	018.3004.422	40	20x1.5	20x1.5	20x1.5	24	24	24	19	36.0	36.0	23.5	23.5	10.0	V0	19.290	

Anwendungsbeispiele:

Exemples d'utilisation:

Sample combinations:

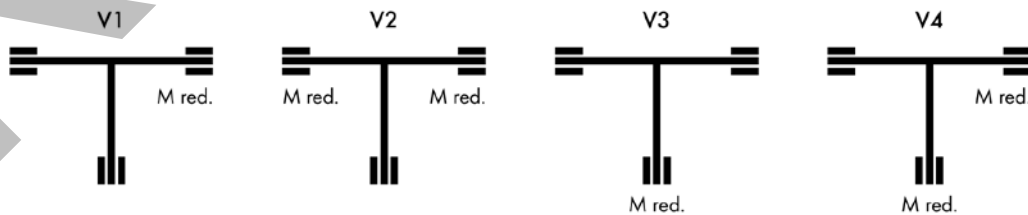

V0 = nicht reduziertes Grundteil

V0 = corps de raccord non réduit

V0 = not reduced union body

V1 - V4 = Versionen mit reduziertem Grundteil

V1 - V4 = versions avec corps de raccord réduit

V1 - V4 = versions with reduced union bodies

Fortsetzung nächste Seite

Suite à la prochaine page

Continued on next page

d=Rohrassen-ø
 e=kleinste Bohrung
 L=Mass in montiertem Zustand
 *=mit reduziertem Klemmring

d=ø extérieur du tube
 e=ø-min. de passage
 L=après montage
 *=avec bague de serrage de réduction

d=tube outside diameter
 e=minimum bore
 L=installed length
 *=with reduction compression ferrule

T-Verschraubung reduziert
Té réduit
Tee reduction union

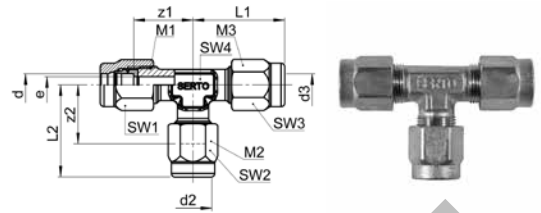

SO 43021 RED

Type	d	d2	d3	Mat.-Nr.	bar	M1	M2	M3	SW1	SW2	SW3	SW4	L1	L2	z1	z2	e	Vers.	kg/100
SO 43021-15-15-10				018.3004.433	40	20x1.5	20x1.5	14x1.0	24	24	17	19	36.0	36.0	23.5	23.5	8.0	V1	16.230
★ SO 43021-15-15-12				018.3004.435	40	20x1.5	20x1.5	20x1.5	24	24	24	19	36.0	36.0	23.5	23.5	10.0	V0	19.290
★ SO 43021-15-18-15				018.3004.447	40	24x1.5	24x1.5	24x1.5	27	27	27	22	40.5	40.5	26.5	26.5	13.0	V0	27.100
SO 43021-15-22-15				018.3004.453	25	20x1.5	28x1.5	20x1.5	24	32	24	27	43.0	48.0	30.5	30.5	12.0	V2	29.500
★ SO 43021-17-10-17				018.3004.468	40	24x1.5	16x1.0	24x1.5	27	19	27	22	40.5	36.0	26.5	26.5	8.5	V3	23.170
SO 43021-17-12-17				018.3004.480	40	24x1.5	16x1.0	24x1.5	27	19	27	22	40.5	36.0	26.5	26.5	10.0	V3	22.850
★ SO 43021-17-14-14				018.3004.498	40	24x1.5	24x1.5	24x1.5	27	27	27	22	40.5	40.5	26.5	26.5	12.0	V0	27.800
★ SO 43021-17-14-17				018.3004.502	40	24x1.5	24x1.5	24x1.5	27	27	27	22	40.5	40.5	26.5	26.5	12.0	V0	27.400
★ SO 43021-17-17-14				018.3004.518	40	24x1.5	24x1.5	24x1.5	27	27	27	22	40.5	40.5	26.5	26.5	12.0	V0	27.400
★ SO 43021-18-10-18				018.3004.584	40	24x1.5	16x1.0	24x1.5	27	19	27	22	40.5	36.0	26.5	26.5	8.5	V3	22.750
SO 43021-18-12-18				018.3004.599	40	24x1.5	16x1.0	24x1.5	27	19	27	22	40.5	36.0	26.5	26.5	10.0	V3	22.430
★ SO 43021-18-15-15				018.3004.624	40	24x1.5	24x1.5	24x1.5	27	27	27	22	40.5	40.5	26.5	26.5	13.0	V0	27.100
★ SO 43021-18-15-18				018.3004.628	40	24x1.5	24x1.5	24x1.5	27	27	27	22	40.5	40.5	26.5	26.5	13.0	V0	26.350
★ SO 43021-18-18-15				018.3004.644	40	24x1.5	24x1.5	24x1.5	27	27	27	22	40.5	40.5	26.5	26.5	13.0	V0	26.350
★ SO 43021-22-12-22				018.3004.740	25	28x1.5	20x1.5	28x1.5	32	24	32	27	48.0	41.5	30.5	30.5	10.0	V3	34.600
SO 43021-22-14-22				018.3004.784	25	28x1.5	20x1.5	28x1.5	32	24	32	27	48.0	41.5	30.5	30.5	12.0	V3	34.300
SO 43021-22-15-22				018.3004.800	25	28x1.5	20x1.5	28x1.5	32	24	32	27	48.0	41.5	30.5	30.5	12.0	V3	34.100
★ SO 43021-22-17-22				018.3004.824	25	28x1.5	28x1.5	28x1.5	32	32	32	27	48.0	48.0	30.5	30.5	15.0	V0	39.100
★ SO 43021-22-18-22				018.3004.862	25	28x1.5	28x1.5	28x1.5	32	32	32	27	48.0	48.0	30.5	30.5	16.0	V0	38.900

Für Zollrohre

Pour tubes pouces

For inch tubes

SO 43021-9,52-6,35-9,52	018.3004.126	125	14x1.0	10x1.0	14x1.0	17	12	17	14	30.5	26.5	20.5	20.5	4.0	V3	7.440
★ SO 43021-12,7-9,52-12,7	018.3004.270	40	20x1.5	14x1.0	20x1.5	24	17	24	19	36.0	33.5	23.5	23.5	8.0	V3	17.860
SO 43021-19,05-12,7-19,05	018.3004.689	25	28x1.5	20x1.5	28x1.5	32	24	32	27	48.0	41.5	30.5	30.5	11.0	V3	34.000

Umrechnung für "d" bei Zollrohren:

6,35 = 1/4
 9,52 = 3/8
 12,7 = 1/2
 19,05 = 3/4

Conversion de "d" pour tubes en pouces:

6,35 = 1/4
 9,52 = 3/8
 12,7 = 1/2
 19,05 = 3/4

Conversion for "d" for inch tubes:

6,35 = 1/4
 9,52 = 3/8
 12,7 = 1/2
 19,05 = 3/4

Anwendungsbeispiele:

Exemples d'utilisation:

Sample combinations:

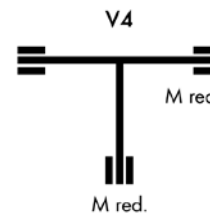
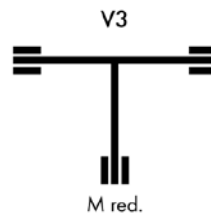
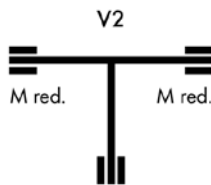
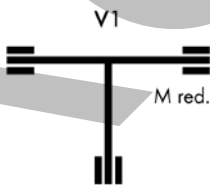

V0 = nicht reduziertes Grundteil

V1 - V4 = Versionen mit reduziertem Grundteil

V0 = corps de raccord non réduit

V1 - V4 = versions avec corps de raccord réduit

V0 = not reduced union body

V1 - V4 = versions with reduced union bodies

Weitere reduzierte T-Verschraubungen können mit dem Klemmring reduziert SO 40001 RED oder der Reduktion SO 41821 zusammengesetzt werden.

D'autres téés réduits peuvent s'obtenir par bague de serrage de réduction SO 40001 RED ou par réduction SO 41821.

Further tee reductions can be produced with the reduction compression ferrule SO 40001 RED or the reduction union SO 41821.

d=Rohrassen-ø
 e=kleinste Bohrung
 L=Mass in montiertem Zustand
 *=mit reduziertem Klemmring

d=ø extérieur du tube
 e=ø-min. de passage
 L=après montage
 *=avec bague de serrage de réduction

d=tube outside diameter
 e=minimum bore
 L=installed length
 *=with reduction compression ferrule

T-Verschraubung

mit Übergangsnippel SO 40040

Té égal

avec adaptateur mâle SO 40040

Tee union

with male adaptor SO 40040

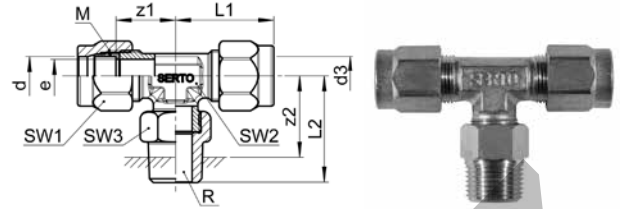

SO 43121

Type -d-R-d3	Mat.-Nr.	bar	M	SW1	SW2	SW3	L1	L2	z1	z2	e	kg/100
R=Rohrgewinde (kegelig)												

T-Verschraubung

mit Übergangsnippel SO 40040 NPT

Té égal

avec adaptateur mâle SO 40040 NPT

Tee union

with male adaptor SO 40040 NPT

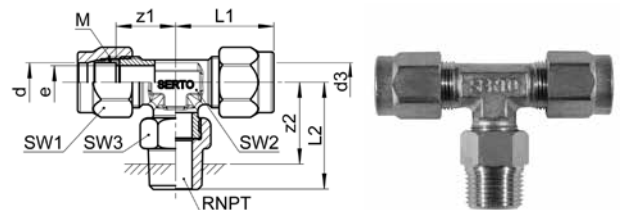

SO 43121 NPT

Type -d-RNPT-d3	Mat.-Nr.	bar	M	SW1	SW2	SW3	L1	L2	z1	z2	e	kg/100
RNPT=NPT Gewinde												

Montagehinweis: Nippel ist handfest montiert. Bei Endmontage mit 1/4 Umdrehung anziehen.
Wir empfehlen eine zusätzliche Schmierung auf der Planfläche.

Note d'installation: L'adaptateur femelle-mâle est monté serré à la main. Pour le montage final, serrer avec 1/4 de tour.
Nous recommandons une lubrification supplémentaire sur la surface plane.

Assembly information: Male adaptor is mounted finger-tight. For final assembly, tighten with 1/4 turn.
We recommend additional lubrication on the plane surface.

d=Rohrtaussendungs-Ø
e=kleinste Bohrung
L=Mass in montiertem Zustand

d=Ø extérieur du tube
e=Ø-min. de passage
L=après montage

d=tube outside diameter
e=minimum bore
L=installed length

T-Verschraubung

mit Übergangsmuffe SO 40030

Té égal

avec adaptateur femelle SO 40030

Tee union

with female adaptor SO 40030

SO 43221

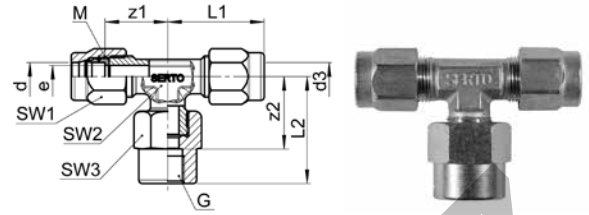

Type -d-G-d3	Mat.-Nr.	bar	M	SW1	SW2	SW3	L1	L2	z1	z2	e	kg/100
Für metrische Rohre	Pour tubes métriques						For metric tubes					
G=Rohrgewinde (zylindrisch)	G=Filetage-gaz BSP (cylindrique)						G=BSP thread (parallel)					
SO 43221-6-1/8-6	018.3201.100	250	10x1.0	12	10	14	23.5	29.0	16.0	19.0	4.0	5.090
SO 43221-6-1/4-6	018.3201.110	250	10x1.0	12	10	17	23.5	30.0	16.0	19.0	4.0	5.950
SO 43221-6-3/8-6	018.3201.120	250	10x1.0	12	10	22	23.5	31.0	16.0	19.0	4.0	8.220
SO 43221-8-1/8-8	018.3201.160	100	12x1.0	14	10	17	26.0	31.0	18.0	21.0	6.5	7.260
SO 43221-8-1/4-8	018.3201.170	100	12x1.0	14	10	17	26.0	33.0	18.0	22.0	6.5	7.010
SO 43221-8-3/8-8	018.3201.180	100	12x1.0	14	10	22	26.0	33.0	18.0	21.0	6.5	9.250
SO 43221-10-1/4-10	018.3201.270	64	14x1.0	17	14	17	30.5	34.5	20.5	23.5	8.0	9.040
SO 43221-10-3/8-10	018.3201.280	64	14x1.0	17	14	22	30.5	35.5	20.5	23.5	8.0	11.710
* SO 43221-10-1/2-10	018.3201.290	64	16x1.0	19	17	27	32.5	38.5	21.5	24.5	10.0	16.530
SO 43221-12-1/4-12	018.3201.380	64	16x1.0	19	17	19	32.5	35.5	21.5	24.5	10.0	11.990
SO 43221-12-3/8-12	018.3201.390	64	16x1.0	19	17	22	32.5	36.5	21.5	24.5	10.0	13.070
SO 43221-12-1/2-12	018.3201.400	64	16x1.0	19	17	27	32.5	38.5	21.5	24.5	10.0	16.250
SO 43221-14-1/2-14	018.3201.540	40	20x1.5	24	19	27	36.0	41.0	23.5	27.0	12.0	22.280
SO 43221-14-3/4-14	018.3201.550	40	20x1.5	24	19	32	36.0	44.0	23.5	27.0	12.0	26.130
SO 43221-15-3/8-15	018.3201.580	40	20x1.5	24	19	24	36.0	39.0	23.5	27.0	13.0	19.610
SO 43221-15-1/2-15	018.3201.590	40	20x1.5	24	19	27	36.0	41.0	23.5	27.0	13.0	21.640
SO 43221-15-3/4-15	018.3201.600	40	20x1.5	24	19	32	36.0	44.0	23.5	27.0	13.0	25.490
SO 43221-17-1/2-17	018.3201.680	40	24x1.5	27	22	30	40.5	45.0	26.5	31.0	15.0	30.300
SO 43221-17-3/4-17	018.3201.690	40	24x1.5	27	22	32	40.5	48.0	26.5	31.0	15.0	31.240
SO 43221-18-1/2-18	018.3201.730	40	24x1.5	27	22	30	40.5	45.0	26.5	31.0	15.0	29.760
SO 43221-22-3/4-22	018.3201.830	25	28x1.5	32	27	36	48.0	52.0	30.5	35.0	19.0	43.340

Für Zollrohre

Pour tubes pouces

For inch tubes

SO 43221-6,35-1/8-6,35	018.3201.140	250	10x1.0	12	10	14	23.5	29.0	16.0	19.0	4.0	5.060
------------------------	--------------	-----	--------	----	----	----	------	------	------	------	-----	-------

Umrechnung für "d" bei Zollrohren:
6,35 = 1/4

Conversion de "d" pour tubes en pouces:
6,35 = 1/4

Conversion for "d" for inch tubes:
6,35 = 1/4

Montagehinweis: Muffe ist handfest montiert. Bei Endmontage mit 1/4 Umdrehung anziehen.

Wir empfehlen eine zusätzliche Schmierung auf der Planfläche.

Note d'installation: L'adaptateur femelle est monté serré à la main. Pour le montage final, serrez avec 1/4 de tour.

Nous recommandons une lubrification supplémentaire sur la surface plane.

Assembly information: Female adaptor is mounted finger-tight. For final assembly, tighten with 1/4 turn.

We recommend additional lubrication on the plane surface.

d=Rohrtaussen-ø
e=kleinste Bohrung
L=Mass in montiertem Zustand
*=mit reduziertem Klemmring

d=ø extérieur du tube
e=ø-min. de passage
L=après montage
*=avec bague de serrage de réduction

d=tube outside diameter
e=minimum bore
L=installed length
*=with reduction compression ferrule

Einstellbare T-Verschraubung

Té orientable au centre

Adjustable tee union

SO 43621 T

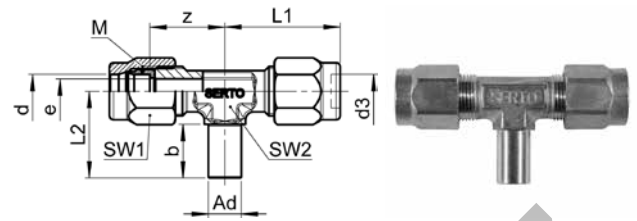

Type -d -Ad -d3	Mat.-Nr.	bar	M	SW1	SW2	L1	L2	b	z	e	kg/100
* SO 43621-4-A6-4	018.3600.045	100	10x1.0	12	10	23.5	17.5	11.0	16.0	3.4	3.540
* SO 43621-5-A6-5	018.3600.053	100	10x1.0	12	10	23.5	17.5	11.0	16.0	4.0	3.500
SO 43621-6-A6-6	018.3600.060	200	10x1.0	12	10	23.5	17.5	11.0	16.0	4.0	3.160
* SO 43621-6-A8-6	018.3600.063	100	12x1.0	14	10	26.0	21.0	13.0	18.0	4.5	4.670
SO 43621-8-A8-8	018.3600.080	100	12x1.0	14	10	26.0	21.0	13.0	18.0	6.0	4.230
* SO 43621-8-A10-8	018.3600.083	80	14x1.0	17	14	30.5	26.0	16.5	20.5	6.5	7.940
SO 43621-10-A10-10	018.3600.100	80	14x1.0	17	14	30.5	26.0	16.5	20.5	8.0	6.970

Anwendungsbeispiele:

Exemples d'utilisation:

Sample combinations:

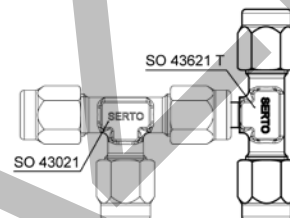
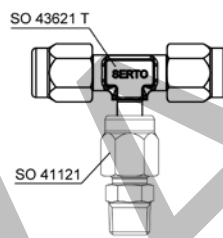
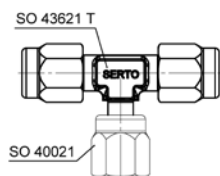

Mögliche Kombinationen:

- mit Armaturenanschluss zu einstellbaren T-Verschraubungen
- mit Verschraubungen zu einstellbaren Verschraubungen
- mit Einschraubverschraubungen zu einstellbaren T-Einschraubverschraubungen. Gegenüber der T-Einschraubverschraubung lässt sich diese Kombination einfacher einstellen, da Einschrauben und Ausrichten getrennt voneinander vorgenommen werden.

Combinaisons possibles:

- avec écrou de raccordement ça donne un Té orientable
- avec raccords ça donne des raccords orientables
- avec une union mâle ça donne un Té fileté orientable. Par rapport au Té orientable, cette combinaison est facile à régler, puisque le vissage et l'alignement sont réalisés séparément l'un de l'autre.

Possible combinations:

- with nut connections to adjustable tee unions
- with unions to adjustable unions
- with male adaptor unions to adjustable male adaptor tee unions. This combination is simpler to produce, as screwing in and alignment are carried out separately.

d=Rohrassens-ø
Ad=Aussen-ø der Andrehung
e=kleinste Bohrung
L=Mass in montiertem Zustand
*=mit reduziertem Klemmring

d=ø extérieur du tube
Ad=ø extérieur de la portée cylindrique
e=ø-min. de passage
L=après montage
*=avec bague de serrage de réduction

d=tube outside diameter
Ad=outside diameter of cyl. stub
e=minimum bore
L=installed length
*=with reduction compression ferrule

Einstellbare L-Verschraubung

Té orientable en bout

Adjustable L union

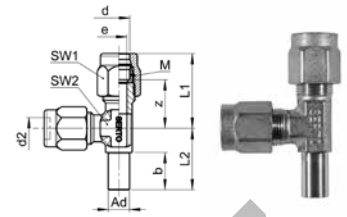

SO 43621 L

Type -d -d2 -Ad	Mat.-Nr.	bar	M	SW1	SW2	L1	L2	b	z	e	kg/100
* SO 43621-4-4-A6	018.3610.045	100	10x1.0	12	10	23.5	17.5	11.0	16.0	3.4	3.600
* SO 43621-5-5-A6	018.3610.053	100	10x1.0	12	10	23.5	17.5	11.0	16.0	4.0	3.560
SO 43621-6-6-A6	018.3610.060	200	10x1.0	12	10	23.5	17.5	11.0	16.0	4.0	3.220
* SO 43621-6-6-A8	018.3610.063	100	12x1.0	14	10	26.0	21.0	13.0	18.0	4.5	4.700
SO 43621-8-8-A8	018.3610.080	100	12x1.0	14	10	26.0	21.0	13.0	18.0	6.0	4.260
* SO 43621-8-8-A10	018.3610.083	80	14x1.0	17	14	30.5	26.0	16.5	20.5	6.5	7.970
SO 43621-10-10-A10	018.3610.100	80	14x1.0	17	14	30.5	26.0	16.5	20.5	8.0	7.000

Anwendungsbeispiele:

Exemples d'utilisation:

Sample combinations:

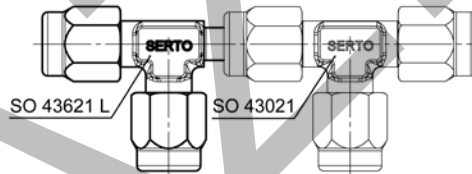
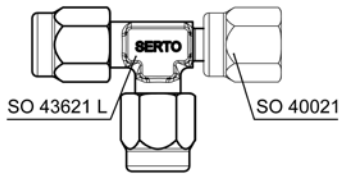

Mögliche Kombinationen:

- mit Armaturenanschluss zu einstellbaren L-Verschraubungen
- mit Verschraubungen zu einstellbaren Verschraubungen
- mit Einschraubverschraubungen zu einstellbaren L-Einschraubverschraubungen. Gegenüber der L-Einschraubverschraubung lässt sich diese Kombination einfacher einstellen, da Einschrauben und Ausrichten getrennt voneinander vorgenommen werden.

Combinaisons possibles:

- avec écrou de raccordement ça donne un L orientable
- avec raccords ça donne des raccords orientables
- avec une union mâle ça donne un L fileté orientable. Par rapport au L orientable, cette combinaison est facile à régler, puisque le vissage et l'alignement sont réalisés séparément l'un de l'autre.

Possible combinations:

- with nut connections to adjustable L unions
- with unions to adjustable unions
- with male adaptor unions to adjustable male adaptor L unions. This combination is simpler to produce, as screwing in and alignment are carried out separately.

d=Rohrassens-ø
 Ad=Aussen-ø der Andrehung
 e=kleinste Bohrung
 L=Mass in montiertem Zustand
 *=mit reduziertem Klemmring

d=ø extérieur du tube
 Ad=ø extérieur de la portée cylindrique
 e=ø-min. de passage
 L=après montage
 *=avec bague de serrage de réduction

d=tube outside diameter
 Ad=outside diameter of cyl. stub
 e=minimum bore
 L=installed length
 *=with reduction compression ferrule

Einstellbare T-Verschraubung vormontiert

Té orientable au centre prémonté

Adjustable tee union pre-assembled

SO 43625 T

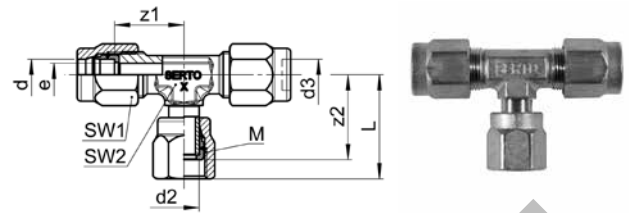

Type -d -d2 -d3	Mat.-Nr.	bar	M	SW1	SW2	L	z1	z2	e	kg/100
* SO 43625-4-A6-4	018.3620.045	100	10x1.0	12	10	23.5	16.0	18.5	3.4	4.380
* SO 43625-5-A6-5	018.3620.053	100	10x1.0	12	10	23.5	16.0	18.5	4.0	4.340
SO 43625-6-A6-6	018.3620.060	200	10x1.0	12	10	23.5	16.0	18.5	4.0	4.000
* SO 43625-6-A8-6	018.3620.063	100	12x1.0	14	10	28.0	18.0	22.0	4.5	5.790
SO 43625-8-A8-8	018.3620.080	100	12x1.0	14	10	28.0	18.0	22.0	6.0	5.350
* SO 43625-8-A10-8	018.3620.083	80	14x1.0	17	14	33.0	20.5	27.0	6.5	9.830
SO 43625-10-A10-10	018.3620.100	80	14x1.0	17	14	33.0	20.5	27.0	8.0	8.860

Einstellbare L-Verschraubung vormontiert

Té orientable en bout prémonté

Adjustable L union pre-assembled

SO 43625 L

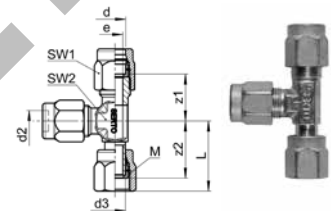

Type -d -d2 -d3	Mat.-Nr.	bar	M	SW1	SW2	L	z1	z2	e	kg/100
* SO 43625-4-4-A6	018.3630.045	100	10x1.0	12	10	23.5	16.0	18.5	3.4	4.400
* SO 43625-5-5-A6	018.3630.053	100	10x1.0	12	10	23.5	16.0	18.5	4.0	4.400
SO 43625-6-6-A6	018.3630.060	200	10x1.0	12	10	23.5	16.0	18.5	4.0	4.060
* SO 43625-6-6-A8	018.3630.063	100	12x1.0	14	10	28.0	18.0	22.0	4.5	5.820
SO 43625-8-8-A8	018.3630.080	100	12x1.0	14	10	28.0	18.0	22.0	6.0	5.380
* SO 43625-8-8-A10	018.3630.083	80	14x1.0	17	14	33.0	20.5	27.0	6.5	9.860
SO 43625-10-10-A10	018.3630.100	80	14x1.0	17	14	33.0	20.5	27.0	8.0	8.890

Montagehinweis: Anschlussmutter auf Seite Einstellteil mit 1/4 Umdrehung anziehen. Wir empfehlen eine zusätzliche Schmierung auf der Planfläche.

Note d'installation: Serrez l'écrou du côté orientable de 1/4 de tour. Nous recommandons une lubrification supplémentaire sur la surface plane.

Assembly information: Tighten the union nut on the adjustable side with 1/4 turn. We recommend additional lubrication on the plane surface.

d=Rohrassen-ø
e=kleinste Bohrung
L=Mass in montiertem Zustand
*=mit reduziertem Klemmring

d=ø extérieur du tube
e=ø-min. de passage
L=après montage
*=avec bague de serrage de réduction

d=tube outside diameter
e=minimum bore
L=installed length
*=with reduction compression ferrule

T-Einschraubverschraubung

Té mâle au centre

Male adaptor tee union

SO 43721 T

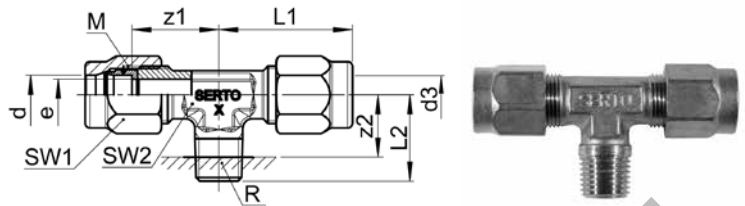

Type -d -R -d3	Mat.-Nr.	bar	M	SW1	SW2	L1	L2	z1	z2	e	kg/100
Für metrische Rohre R=Rohrgewinde (kegelig)	Pour tubes métriques R=Filetage-gaz BSP (conique)	For metric tubes R=BSP thread (tapered)									
* SO 43721-3-1/8-3	018.3701.030	125	8x1.0	10	10	22.5	17.0	16.0	10.5	2.5	2.390
SO 43721-4-1/8-4	018.3701.040	125	8x1.0	10	10	22.0	17.0	16.0	10.5	3.4	2.350
* SO 43721-4-1/4-4	018.3701.045	125	10x1.0	12	10	25.5	21.5	18.0	13.0	3.4	4.110
SO 43721-5-1/8-5	018.3701.070	125	8x1.0	10	10	22.5	17.0	16.0	10.5	4.0	2.330
* SO 43721-5-1/4-5	018.3701.075	125	10x1.0	12	10	25.5	21.5	18.0	13.0	4.0	4.060
SO 43721-6-1/8-6	018.3701.100	250	10x1.0	12	10	23.5	17.5	16.0	11.0	4.0	3.240
SO 43721-6-1/4-6	018.3701.110	250	10x1.0	12	10	25.5	21.5	18.0	13.0	4.0	4.000
* SO 43721-8-1/8-8	018.3701.160	150	12x1.0	14	10	26.0	18.0	18.0	13.0	6.0	4.800
SO 43721-8-1/4-8	018.3701.170	150	12x1.0	14	10	26.0	22.5	18.0	13.0	6.0	4.730
SO 43721-10-1/4-10	018.3701.270	125	14x1.0	17	14	30.5	25.0	20.5	15.5	8.0	7.900
Für Zollrohre	Pour tubes pouces	For inch tubes									
SO 43721-6,35-1/8-6,35	018.3701.140	250	10x1.0	12	10	23.5	17.5	16.0	11.0	4.0	3.210
SO 43721-6,35-1/4-6,35	018.3701.145	250	10x1.0	12	10	25.5	21.5	18.0	13.0	4.0	3.970
SO 43721-9,52-1/4-9,52	018.3701.210	125	14x1.0	17	14	30.5	25.0	20.5	15.5	8.0	7.210

Umrechnung für "d" bei Zollrohren:
6,35 = 1/4
9,52 = 3/8

Conversion de "d" pour tubes en pouces:
6,35 = 1/4
9,52 = 3/8

Conversion for "d" for inch tubes:
6,35 = 1/4
9,52 = 3/8

Weitere Varianten siehe T-Verschraubung mit Übergangsnippel SO 43121.

Autres variantes voir Té avec adaptateur mâle SO 43121.

Further versions see Tee union with male adaptor SO 43121.

T-Einschraubverschraubung

METR

Té mâle au centre METR

Male adaptor tee union

METR

SO 43724 T METR

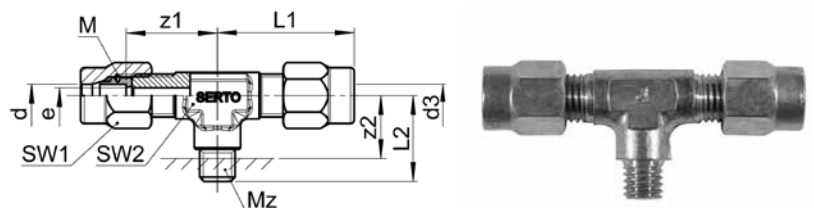

Type -d -Mz -d3	Mat.-Nr.	bar	M	SW1	SW2	L1	L2	z1	z2	e	kg/100
Mz=metrisches Gewinde (zylindrisch)	Mz=Filetage métrique (cylindrique)	Mz=Metric thread (parallel)									
SO 43724-2-M5-2	018.3743.050	125	6x0.75	8	7	16.5	12.0	12.5	8.5	1.5	1.210
SO 43724-3-M5-3	018.3743.055	125	6x0.75	8	7	18.0	12.0	13.0	8.5	2.2	1.290

Wir empfehlen die Verwendung der Dichtung SO 40007 oder SO 40507.
Die entsprechende Dichtung SO 40007 / SO 40507 ist separat zu bestellen.

Nous recommandons l'utilisation du joint SO 40007 ou SO 40507.
Le joint correspondant SO 40007 / SO 40507 doit être commandé séparément.

We recommend the use of the washer SO 40007 or SO 40507.
The relevant washer SO 40007 / SO 40507 must be ordered separately.

d=Rohrassen-ø
e=kleinste Bohrung
L=Mass in montiertem Zustand
*=mit reduziertem Klemmring

d=ø extérieur du tube
e=ø-min. de passage
L=après montage
*=avec bague de serrage de réduction

d=tube outside diameter
e=minimum bore
L=installed length
*=with reduction compression ferrule

L-Einschraubverschraubung

Té mâle en bout

Male adaptor L union

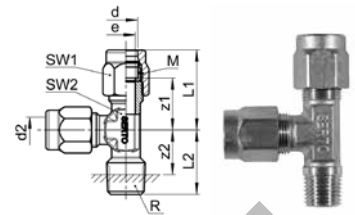

SO 43721 L

Type -d -d2 -R	Mat.-Nr.	bar	M	SW1	SW2	L1	L2	z1	z2	e	kg/100
Für metrische Rohre R=Rohrgewinde (kegelig)	Pour tubes métriques R=Filetage-gaz BSP (conique)	For metric tubes R=BSP thread (tapered)									
★ SO 43721-3-3-1/8	018.3711.030	125	8x1.0	10	10	22.5	17.5	16.0	10.5	2.5	2.410
SO 43721-4-4-1/8	018.3711.050	125	8x1.0	10	10	22.0	17.5	16.0	10.5	3.4	2.370
SO 43721-5-5-1/8	018.3711.070	125	8x1.0	10	10	22.5	17.5	16.0	10.5	4.0	2.350
SO 43721-6-6-1/8	018.3711.100	250	10x1.0	12	10	23.5	17.5	16.0	11.0	4.0	3.520
★ SO 43721-4-4-1/4	018.3711.140	125	10x1.0	12	10	25.5	21.5	18.0	13.0	3.4	4.180
★ SO 43721-5-5-1/4	018.3711.160	125	10x1.0	12	10	25.5	21.5	18.0	13.0	4.0	4.130
SO 43721-6-6-1/4	018.3711.180	250	10x1.0	12	10	23.5	21.5	18.0	13.0	4.0	4.070
SO 43721-8-8-1/4	018.3711.220	150	12x1.0	14	10	26.0	22.5	18.0	13.0	6.0	4.750
SO 43721-10-10-1/4	018.3711.260	125	14x1.0	17	14	30.5	25.0	20.5	15.5	8.0	7.040

Für Zollrohre

Pour tubes pouces

For inch tubes

SO 43721-6,35-6,35-1/8	018.3711.110	250	10x1.0	12	10	23.5	17.5	16.0	11.0	4.0	3.490
SO 43721-6,35-6,35-1/4	018.3711.190	250	10x1.0	12	10	23.5	21.5	18.0	13.0	4.0	4.040
SO 43721-9,52-9,52-1/4	018.3711.240	125	14x1.0	17	14	30.5	25.0	20.5	15.5	8.0	7.160

Umrechnung für "d" bei Zollrohren:

6,35 = 1/4
9,52 = 3/8

Conversion de "d" pour tubes en pouces:

6,35 = 1/4
9,52 = 3/8

Conversion for "d" for inch tubes:

6,35 = 1/4
9,52 = 3/8

L-Einschraubverschraubung METR

Té mâle en bout METR

Male adaptor L union METR

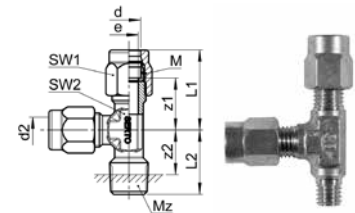

SO 43724 L METR

Type -d -d2 -Mz	Mat.-Nr.	bar	M	SW1	SW2	L1	L2	z1	z2	e	kg/100
Mz=metrisches Gewinde (zylindrisch)	Mz=Filetage métrique (cylindrique)	Mz=Metric thread (parallel)									
SO 43724-2-2-M5	018.3753.050	125	6x0.75	8	7	16.5	12.0	12.5	8.5	1.5	1.180
SO 43724-3-3-M5	018.3753.055	125	6x0.75	8	7	18.0	12.0	13.0	8.5	2.2	1.260

Wir empfehlen die Verwendung der Dichtung SO 40007 oder SO 40507.

Die entsprechende Dichtung SO 40007 / SO 40507 ist separat zu bestellen.

Nous recommandons l'utilisation du joint SO 40007 ou SO 40507.

Le joint correspondant SO 40007 / SO 40507 doit être commandé séparément.

TWe recommend the use of the washer SO 40007 or SO 40507.

The relevant washer SO 40007 / SO 40507 must be ordered separately.

d=Rohrassens-ø
e=kleinste Bohrung
L=Mass in montiertem Zustand
*=mit reduziertem Klemmring

d=ø extérieur du tube
e=ø-min. de passage
L=après montage
*=avec bague de serrage de réduction

d=tube outside diameter
e=minimum bore
L=installed length
*=with reduction compression ferrule

T-Schwenkverschraubung

Té banjo

Tee banjo

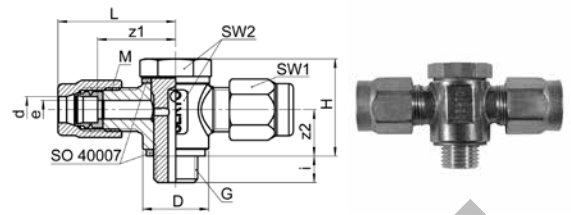

SO 43824

Type -d-G	Mat.-Nr.	bar	M	SW1	SW2	L	D	H	i	z1	z2	e	kg/100
Für metrische Rohre G=Rohrgewinde (zylindrisch)	Pour tubes métriques G=Filetage-gaz BSP (cylindrique)	For metric tubes G=BSP thread (parallel)											
* SO 43824-4-1/8	018.3841.060	125	10x1.0	12	14	25.0	15.0	22.0	6.0	17.5	10.5	3.4	4.130
* SO 43824-5-1/8	018.3841.082	125	10x1.0	12	14	25.0	15.0	22.0	6.0	17.5	10.5	3.8	4.410
SO 43824-6-1/8	018.3841.100	250	10x1.0	12	14	25.0	15.0	22.0	6.0	17.5	10.5	3.8	5.180
* SO 43824-6-1/4	018.3841.110	250	12x1.0	14	19	29.0	20.0	29.0	7.0	21.0	14.0	4.5	9.610
SO 43824-8-1/8	018.3841.160	150	12x1.0	14	14	25.5	15.0	22.0	6.0	17.5	10.5	3.8	5.970
SO 43824-8-1/4	018.3841.170	150	12x1.0	14	19	29.0	20.0	29.0	7.0	21.0	14.0	6.0	9.450
Für Zollrohre	Pour tubes pouces	For inch tubes											
SO 43824-6,35-1/8	018.3841.135	250	10x1.0	12	14	25.0	15.0	22.0	6.0	17.5	9.5	3.8	5.150

Umrechnung für "d" bei Zollrohren:
6,35 = 1/4

Conversion de "d" pour tubes en pouces:
6,35 = 1/4

Conversion for "d" for inch tubes:
6,35 = 1/4

Dichtungen werden mitgeliefert.
Ersatzdichtungen siehe SO 40007.

Les joints sont fournis.
Joints de rechange voir SO 40007.

The washers are included.
Replacement washers see SO 40007.

Sicherheitsfaktor Betriebsdruck (PN): 1.5-fach

Facteur de sécurité pression de service (PN):
1.5 fois

Safety factor working pressure (PN): 1.5 times

d=Rohrassens-ø
e=kleinste Bohrung
L=Mass in montiertem Zustand
*=mit reduziertem Klemmring

d=ø extérieur du tube
e=ø-min. de passage
L=après montage
*=avec bague de serrage de réduction

d=tube outside diameter
e=minimum bore
L=installed length
*=with reduction compression ferrule

T-Schwenkverschraubung METR

Té banjo METR

Tee banjo METR

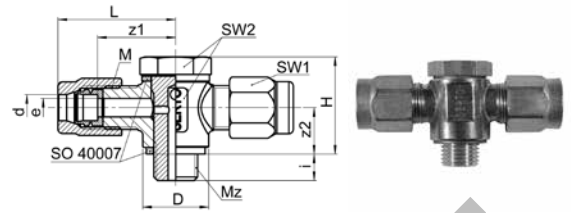

SO 43824 METR

Type -d -Mz	Mat.-Nr.	bar	M	SW1	SW2	L	D	H	i	z1	z2	e	kg/100
Für metrische Rohre	Pour tubes métriques	For metric tubes											
Mz=metrisches Gewinde (zylindrisch)	Mz=Filetage métrique (cylindrique)	Mz=Metric thread (parallel)											
* SO 43824-4-M10x1	018.3843.096	125	10x1.0	12	14	25.0	15.0	22.0	6.0	17.5	10.5	3.4	4.440
* SO 43824-5-M10x1	018.3843.135	125	10x1.0	12	14	25.0	15.0	22.0	6.0	17.5	10.5	3.8	4.430
SO 43824-6-M10x1	018.3843.180	250	10x1.0	12	14	25.0	15.0	22.0	6.0	17.5	10.5	3.8	5.240
* SO 43824-6-M12x1,5	018.3843.195	250	12x1.0	14	19	29.0	20.0	29.0	7.0	21.0	13.5	4.5	10.110
* SO 43824-6-M14x1,5	018.3843.198	250	12x1.0	14	19	29.0	20.0	29.0	7.0	21.0	13.5	4.5	10.070
SO 43824-8-M10x1	018.3843.230	150	12x1.0	14	14	25.0	15.0	22.0	6.0	21.0	10.5	3.8	6.050
SO 43824-8-M12x1,5	018.3843.240	150	12x1.0	14	19	29.0	20.0	29.0	7.0	21.0	13.5	6.0	9.790
SO 43824-8-M14x1,5	018.3843.245	150	12x1.0	14	19	29.0	20.0	29.0	7.0	21.0	13.5	6.0	9.750
Für Zollrohre	Pour tubes pouces	For inch tubes											
SO 43824-6,35-M10x1	018.3843.210	250	10x1.0	12	14	25.0	15.0	22.0	6.0	17.5	10.5	3.8	5.230

Umrechnung für "d" bei Zollrohren:
6,35 = 1/4

Conversion de "d" pour tubes en pouces:
6,35 = 1/4

Conversion for "d" for inch tubes:
6,35 = 1/4

Dichtungen werden mitgeliefert.
Ersatzdichtungen siehe SO 40007.

Les joints sont fournis.
Joints de rechange voir SO 40007.

The washers are included.
Replacement washers see SO 40007.

Sicherheitsfaktor Betriebsdruck (PN): 1.5-fach

Facteur de sécurité pression de service (PN): 1.5 fois

Safety factor working pressure (PN): 1.5 times

d=Rohrassen-ø
e=kleinste Bohrung
L=Mass in montiertem Zustand
*=mit reduziertem Klemmring

d=ø extérieur du tube
e=ø-min. de passage
L=après montage
*=avec bague de serrage de réduction

d=tube outside diameter
e=minimum bore
L=installed length
*=with reduction compression ferrule

2-fach T-Schwenkverschraubung

Té banjo double

Tee double banjo

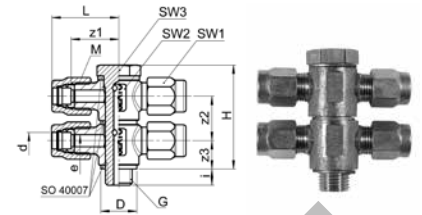

SO 43924

Type - n x d - G	Mat.-Nr.	bar	M	SW1	SW2	SW3	L	D	H	i	z1	z2	z3	e	kg/100
Für metrische Rohre G=Rohrgewinde (zylindrisch)															
★ SO 43924-2x4-1/8	018.3941.060	125	10x1.0	12	14	14	25.0	15.0	38.5	7.0	17.5	16.5	10.5	3.4	7.270
★ SO 43924-2x5-1/8	018.3941.082	125	10x1.0	12	14	14	25.0	15.0	38.5	7.0	17.5	16.5	10.5	3.8	7.830
SO 43924-2x6-1/8	018.3941.100	250	10x1.0	12	14	14	25.0	15.0	38.5	7.0	17.5	16.5	10.5	3.8	9.370
★ SO 43924-2x6-1/4	018.3941.110	250	12x1.0	14	19	19	29.0	20.0	49.0	9.0	21.0	21.5	13.5	4.5	17.270
SO 43924-2x8-1/8	018.3941.160	150	12x1.0	14	14	14	25.5	15.0	38.5	7.0	17.5	16.5	10.5	3.8	10.950
SO 43924-2x8-1/4	018.3941.170	150	12x1.0	14	19	19	29.0	20.0	49.0	9.0	21.0	21.5	13.5	6.0	16.950
Für Zollrohre															
SO 43924-2x6,35-1/8	018.3941.135	250	10x1.0	12	14	14	25.0	15.0	38.5	7.0	17.5	16.5	10.5	3.8	9.310

Umrechnung für "d" bei Zollrohren:
6,35 = 1/4

Conversion de "d" pour tubes en pouces:
6,35 = 1/4

Conversion for "d" for inch tubes:
6,35 = 1/4

Dichtungen werden mitgeliefert.
Ersatzdichtungen siehe SO 40007.

Les joints sont fournis.
Joints de rechange voir SO 40007.

The washers are included.
Replacement washers see SO 40007.

Sicherheitsfaktor Betriebsdruck (PN): 1.5-fach

Facteur de sécurité pression de service (PN):
1.5 fois

Safety factor working pressure (PN): 1.5 times

n=Anzahl Schwenkkörper
d=Rohraussen-ø
e=kleinste Bohrung
L=Mass in montiertem Zustand
*=mit reduziertem Klemmring

n=nombre d'éléments orientables
d=ø extérieur du tube
e=ø-min. de passage
L=après montage
*=avec bague de serrage de réduction

n=number of swivel bodies
d=tube outside diameter
e=minimum bore
L=installed length
*=with reduction compression ferrule

Kreuzverschraubung
Croix égale
Cross union

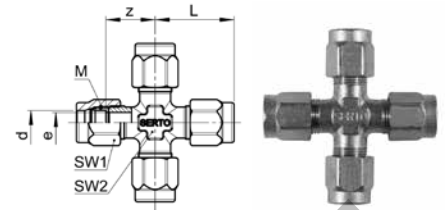

SO 44021

Type -d	Mat.-Nr.	bar	M	SW1	SW2	L	z	e	kg/100
Für metrische Rohre	Pour tubes métriques			For metric tubes					
* SO 44021-4	018.4000.040	125	10x1.0	12	10	25.5	18.0	3.4	4.800
SO 44021-5	018.4000.050	125	8x1.0	10	10	25.0	19.5	3.4	4.800
SO 44021-6	018.4000.060	250	10x1.0	12	10	25.5	18.0	4.0	6.030
SO 44021-8	018.4000.080	150	12x1.0	14	11	28.5	20.5	6.0	7.930
SO 44021-10	018.4000.100	125	14x1.0	17	14	30.5	20.5	8.0	11.880
SO 44021-12	018.4000.120	100	16x1.0	19	14	32.5	21.5	9.0	14.650
* SO 44021-13	018.4000.130	40	20x1.5	24	19	39.0	26.5	11.0	25.770
SO 44021-14	018.4000.140	40	20x1.5	24	19	39.0	26.5	12.0	26.620
SO 44021-15	018.4000.150	40	20x1.5	24	19	39.0	26.5	12.0	25.340
Für Zollrohre	Pour tubes pouces			For inch tubes					
SO 44021-6,35	018.4000.063	250	10x1.0	12	10	25.5	18.0	4.0	5.980
SO 44021-9,52	018.4000.095	125	14x1.0	17	14	30.5	20.5	8.0	12.120
* SO 44021-12,7	018.4000.127	40	20x1.5	24	19	39.0	26.5	11.0	25.770

Umrechnung für "d" bei Zollrohren:

- 6,35 = 1/4
- 9,52 = 3/8
- 12,7 = 1/2

Conversion de "d" pour tubes en pouces:

- 6,35 = 1/4
- 9,52 = 3/8
- 12,7 = 1/2

Conversion for "d" for inch tubes:

- 6,35 = 1/4
- 9,52 = 3/8
- 12,7 = 1/2

d=Rohrassen-ø
 e=kleinste Bohrung
 L=Mass in montiertem Zustand
 *=mit reduziertem Klemmring

d=ø extérieur du tube
 e=ø-min. de passage
 L=après montage
 *=avec bague de serrage de réduction

d=tube outside diameter
 e=minimum bore
 L=installed length
 *=with reduction compression ferrule

Schwenkverschraubung

mit Drossel-Ventil

Coude banjo

avec limiteur de débit

Single banjo

with throttle valve

SO 47624

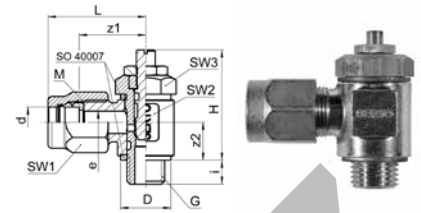

Type -d-G	Mat.-Nr.	bar	M	SW1	SW2	SW3	L	D	H	i	z1	z2	e	kv	kg/100
Für metrische Rohre															
G=Rohrgewinde (zylindrisch)															
* SO 47624-3-1/8	028.7600.040	16	8x1.0	10	14	14	24.0	15.0	26.0	6.5	17.5	10.0	2.5	3.0	4.000
SO 47624-4-1/8	028.7600.060	16	8x1.0	10	14	14	23.5	15.0	26.0	6.5	17.5	10.0	3.4	3.0	3.800
SO 47624-5-1/8	028.7600.082	16	8x1.0	10	14	14	24.0	15.0	26.0	6.5	17.5	10.0	4.0	3.0	3.700
SO 47624-6-1/8	028.7600.100	16	10x1.0	12	14	14	25.0	15.0	26.0	6.5	17.5	10.0	4.0	3.0	4.300
* SO 47624-6-1/4	028.7600.110	16	12x1.0	14	19	19	29.0	20.0	31.5	8.0	21.0	13.5	4.5	6.0	8.600
SO 47624-8-1/8	028.7600.160	16	12x1.0	14	14	14	25.5	15.0	31.5	6.5	17.5	10.0	3.5	3.0	4.600
SO 47624-8-1/4	028.7600.170	16	12x1.0	14	19	19	29.0	20.0	31.5	8.0	21.0	13.5	5.0	6.0	8.400
SO 47624-10-1/4	028.7600.270	16	14x1.0	17	19	19	32.0	20.0	31.5	8.0	21.0	13.5	5.0	6.0	9.000

Für Zollrohre

Pour tubes pouces

For inch tubes

SO 47624-6,35-1/8	028.7600.135	16	10x1.0	12	14	14	25.0	15.0	26.0	6.5	17.5	10.0	3.5	3.0	4.200
SO 47624-9,52-1/4	028.7600.230	16	14x1.0	17	19	19	31.0	20.0	31.5	8.0	21.0	13.5	5.0	6.0	9.100

Umrechnung für "d" bei Zollrohren:

$$6,35 = 1/4$$

$$9,52 = 3/8$$

Conversion de "d" pour tubes en pouces:

$$6,35 = 1/4$$

$$9,52 = 3/8$$

Conversion for "d" for inch tubes:

$$6,35 = 1/4$$

$$9,52 = 3/8$$

Temperatur: -20°C bis +80°C

Température: -20°C à +80°C

Temperature: -20°C to +80°C

Dieses Drossel-Ventil dient zur Regulierung der Ströme von Gas- und Flüssigmedien in beiden Richtungen. Die Spindelfixierung mittels Kontermutter garantiert, dass sich die Spindel auch bei Vibration nicht verstellt.

Einsatz: ideal für Luft, Wasser, Öle

Ce limiteur de débit est utilisé pour réguler le débit des fluides gazeux et liquides dans les deux sens. La fixation de la broche à l'aide d'un contre-écrou garantit que la broche ne se déplace pas, même en cas de vibrations.

Utilisation: idéal pour l'air, l'eau, les huiles

This throttle valve is used to regulate the flow of gas and liquid media in both directions. The spindle fixation by means of a counter-nut assures that spindle does not shift, even in case of vibration.

Use: ideal for air, water oils

Werkstoffe:

Körper, Ventileinsatz, Anschlüsse: Messing

O-Ring: NBR

Matériaux:

Soupepe, pointeau, écrous: laiton

Joint torique: NBR

Materials:

Body, components, connections: brass

O-ring: NBR

Sicherheitsfaktor Betriebsdruck (PN): 1.5-fach

Facteur de sécurité pression de service (PN):

1,5 fois

Safety factor working pressure (PN): 1.5 times

d=Rohrassen-ø

e=kleinste Bohrung

kv=Kenngröße für das Durchflussverhalten (l/min)

L=Mass in montiertem Zustand

*=mit reduziertem Klemmring

d=ø extérieur du tube

e=ø-min. de passage

kv=facteur d'écoulement (l/min)

L=après montage

*=avec bague de serrage de réduction

d=tube outside diameter

e=minimum bore

kv=flow factor (l/min)

L=installed length

*=with reduction compression ferrule

Schwenkverschraubung

mit Drossel-Rückschlagventil

Coude banjo

avec clapet anti-retour limiteur de débit

Single banjo

with throttle non-return valve

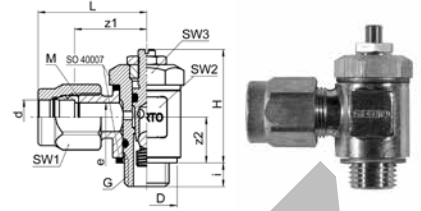

SO 47724

Type -d-G	Mat.-Nr.	bar	M	SW1	SW2	SW3	L	D	H	i	z1	z2	e	kv	kg/100
Für metrische Rohre															
G=Rohrgewinde (zylindrisch)															
* SO 47724-3-1/8	028.7700.040	16	8x1.0	10	14	14	24.0	15.0	26.0	6.5	17.5	10.0	2.5	3.0	4.000
SO 47724-4-1/8	028.7700.060	16	8x1.0	10	14	14	23.5	15.0	26.0	6.5	17.5	10.0	3.4	3.0	3.800
SO 47724-5-1/8	028.7700.082	16	8x1.0	10	14	14	24.0	15.0	26.0	6.5	17.5	10.0	3.5	3.0	3.700
SO 47724-6-1/8	028.7700.100	16	10x1.0	12	14	14	25.0	15.0	26.0	6.5	17.5	10.0	3.5	3.0	4.300
* SO 47724-6-1/4	028.7700.110	16	12x1.0	14	19	19	29.0	20.0	31.5	8.0	21.0	13.5	4.5	6.0	8.600
SO 47724-8-1/8	028.7700.160	16	12x1.0	14	14	14	25.5	15.0	26.0	6.5	17.5	10.0	3.5	3.0	4.600
SO 47724-8-1/4	028.7700.170	16	12x1.0	14	19	19	29.0	20.0	31.5	8.0	21.0	13.5	5.0	6.0	8.400
SO 47724-10-1/4	028.7700.270	16	14x1.0	17	19	19	32.0	20.0	33.5	8.0	21.0	13.5	5.0	6.0	9.700

Für Zollrohre

Pour tubes pouces

For inch tubes

SO 47724-6,35-1/8	028.7700.135	16	10x1.0	12	14	14	25.0	15.0	26.0	6.5	17.5	10.0	3.5	3.0	4.200
SO 47724-9,52-1/4	028.7700.230	16	14x1.0	17	19	19	31.0	20.0	31.5	8.0	21.0	13.5	5.0	6.0	9.100

Umrechnung für "d" bei Zollrohren:

$$6,35 = 1/4$$

$$9,52 = 3/8$$

Conversion de "d" pour tubes en pouces:

$$6,35 = 1/4$$

$$9,52 = 3/8$$

Conversion for "d" for inch tubes:

$$6,35 = 1/4$$

$$9,52 = 3/8$$

Temperatur: -20°C bis +80°C

Température: -20°C à +80°C

Temperatur: -20°C to +80°C

Dieses Drossel-Rückschlagventil dient zur Regulierung von Gas- und Flüssigmedien in eine Richtung und verhindert einen entgegengesetzten Medienfluss. Die Spindelfixierung mittels Kontermutter garantiert, dass sich die Spindel auch bei Vibration nicht verstellt.

Einsatz: ideal für Luft, Wasser, Öle

Ce clapet anti-retour limiteur de débit est utilisé pour réguler les fluides gazeux et liquides dans un sens et empêchent l'écoulement du fluide dans le sens opposé. La fixation de la broche à l'aide d'un contre-écrou garantit que la broche ne se déplace pas, même en cas de vibrations.

Utilisation: idéal pour l'air, l'eau, les huiles

This throttle non-return valve is used to regulate gas and liquid media in one direction and prevents media flow in the opposite direction. The spindle fixation by means of a counter-nut ensures that spindle does not shift, even in case of vibration.

Use: ideal for air, water oils

Werkstoffe:

Körper, Ventileinsatz, Anschlüsse: Messing

O-Ring: NBR

Feder: Edelstahl 1.4310

Kugel: Polyurethan

Sicherheitsfaktor Betriebsdruck (PN): 1.5-fach

Matériaux:

Clapet, pointeau, écrous: laiton

Joint torique: NBR

Ressort: acier inoxydable 1.4310

Bille: polyuréthane

Facteur de sécurité pression de service (PN): 1.5 fois

Materials:

Body, components, connections: brass

O-ring: NBR

Spring: stainless steel 1.4310

Ball: polyurethane

Safety factor working pressure (PN): 1.5 times

d=Rohrassens-ø

e=kleinste Bohrung

kv=Kenngröße für das Durchflussverhalten (l/min)

L=Mass in montiertem Zustand

*=mit reduziertem Klemmring

d=ø extérieur du tube

e=ø-min. de passage

kv=facteur d'écoulement (l/min)

L=après montage

*=avec bague de serrage de réduction

d=tube outside diameter

e=minimum bore

kv=flow factor (l/min)

L=installed length

*=with reduction compression ferrule

Ventile Messing M

Vannes laiton M

Valves brass M

SO NV 41A21



Regulierventil
Vanne de réglage
Regulating valve

483

SO NV 41A30



Regulierventil mit Übergangsmuffe
SO 40030
Vanne de réglage avec adaptateur femelle
SO 40030
Regulating valve with female adaptor
SO 40030

484

SO NV 41A40



Regulierventil mit Übergangsnippel
SO 40040
Vanne de réglage avec adaptateur mâle
SO 40040
Regulating valve with male adaptor
SO 40040

485

SO NV 41C21



Feinregulierventil
Vanne de réglage fin
Fine regulating valve

486

SO NV 41A21E



Regulier-Eckventil
Vanne-équerre de réglage
Elbow regulating valve

487

SO NV 41A30E



Regulier-Eckventil mit Übergangsmuffe
SO 40030
Vanne-équerre de réglage avec adaptateur
femelle SO 40030
Elbow regulating valve with female adaptor
SO 40030

488

SO NV 41A40E



Regulier-Eckventil mit Übergangsnippel
SO 40040
Vanne-équerre avec adaptateur mâle
SO 40040
Elbow regulating valve with male adaptor
SO 40040

489

SO NV 41A21EB



Regulier-Eckventil mit Einschraubgewinde
Vanne-équerre de réglage avec filetage
Elbow regulating valve with male adaptor
thread

490

SO NV 41A21EL



Regulier-Eckventil mit Einstellzapfen
Vanne-équerre de réglage orientable
Elbow regulating valve adjustable

491

SO NV 41C21E



Feinregulier-Eckventil
Vanne-équerre de réglage fin
Elbow fine regulating valve

492

SO NV 41C21EB



Feinregulier-Eckventil mit Einschraubgewinde
Vanne-équerre de réglage fin avec filetage
Elbow fine regulating valve with male
adaptor thread

493

SO NV 41C21EL



Feinregulier-Eckventil mit Einstellzapfen
Vanne-équerre de réglage fin orientable
Elbow fine regulating valve adjustable

494

Ventile Messing M

Vannes laiton M

Valves brass M

SO CV 43A21



Kegelrückschlagventil
Clapet anti-retour à siège conique
Taper seat non-return valve

497

SO CV 43A30



Kegelrückschlagventil mit Übergangsmuffe
SO 40030
Clapet anti-retour à siège conique avec
adaptateur femelle SO 40030
Taper seat non-return valve with female
adaptor SO 40030

498

SO CV 43A40



Kegelrückschlagventil mit Übergangsnippel
SO 40040
Clapet anti-retour à siège conique avec
adaptateur mâle SO 40040
Taper seat non-return valve with male
adaptor SO 40040

499

SO BV 48A00



Mini-Kugelhahn mit Innengewinde
Mini vanne à bille avec taraudage
Mini-ball valve with female thread

502

SO BV 48A05



Mini-Kugelhahn mit Innen-/Aussengewinde
Mini vanne à bille avec taraudage/filetage
Mini-ball valve with female/male thread

503

SO BV 48A10



Mini-Kugelhahn mit Aussengewinde
Mini vanne à bille avec filetage
Mini-ball valve with male thread

504

SO 09900



Anschraubfuss
Support de fixation
Flange mount

552

SO 09950



Handrad für Regulierventile Messing M und
G, Polyamid
Volant pour vannes de réglage laiton M e G,
polyamide
Handwheel for regulating valves brass M
and G, polyamide

552

VSD SO NV



Ventilschilder (Satz)
Plaques signalétiques (set)
Valve labels (set)

553

Adapter Messing M

Adaptateurs laiton M

Adaptors brass M

AD HN 40 R



Doppelnippel R
Mamelon double R
Male adaptor R

666

AD HN 40 R-NPT



Doppelnippel R-NPT
Mamelon double R-NPT
Male threaded adaptor R-NPT

666

AD HN 40 NPT-NPT



Doppelnippel NPT-NPT
Mamelon double NPT-NPT
Male threaded adaptor NPT-NPT

666

ADH HNC 40



Doppelnippel G 60°-Innenkonus
Mamelon double G cône intérieur 60°
Male threaded adaptor G 60° inner cone

667

AD FA 40



Übergangsmuffe G-G
Adaptateur femelle G - femelle G
Female adaptor G-G

667

AD FA 40 NPT



Übergangsmuffe G-NPT
Adaptateur femelle G - femelle NPT
Female adaptor G-NPT

668

AD A 40 G-R



Übergangsnippel G-R
Adaptateur femelle G - mâle R
Adaptor female G - male R

668

AD A 40 G-NPT



Übergangsnippel G-NPT
Adaptateur femelle G - mâle NPT
Adaptor female G - male NPT

669

AD A 40 NPT-R



Übergangsnippel NPT-R
Adaptateur femelle NPT - mâle R
Adaptor female NPT - male R

669

AD A 40 NPT-NPT



Übergangsnippel NPT-NPT
Adaptateur femelle NPT - mâle NPT
Adaptor female NPT - male NPT

670

AD HC 40



Sechskantmuffe
Manchon hexagonal
Hexagonal threaded socket

670

AD HRC 40



Sechskantmuffe reduziert
Manchon hexagonal réduit
Hexagonal threaded socket reduced

670

Adapter Messing M

Adaptateurs laiton M

Adaptors brass M

AD HCP 40



Rohrkappe G mit EPDM-Dichtung
Capuchon G avec joint EPDM
Hexagonal cap G with EPDM sealing

671

AD HP 40 R



Verschlusschraube R mit Aussen-6kt.
Bouchon fileté R à six pans
Screw plug R with hex-nut

671

AD HP 40 NPT



Verschlusschraube NPT mit Aussen-6kt.
Bouchon fileté NPT à six pans
Screw plug NPT with hex-nut

671

AD SP 40



Verschlusschraube R mit Innen-6kt.
Bouchon fileté R avec six pans creux
Screw plug R locked with Allen key

672

AD HPS 40



Verschlusschraube G mit Aussen-6kt.
Bouchon fileté G à six pans
Screw plug G with hex-nut

672

AD HPO 40



Verschlusschraube G mit Aussen-6kt. und
Conovor O-Ringabdichtung (NBR)
Bouchon fileté G à six pans, avec joint
torique système Conovor (NBR)
Screw plug G with hex-nut and Conovor
O-ring seal (NBR)

673

AD HSP 40



Verschlusschraube G mit Innen-6kt.
Bouchon fileté G avec six pans creux
Screw plug G locked with Allen key

673

AD HSPO 40



Verschlusschraube G mit Innen-6kt. und
Conovor O-Ringabdichtung (NBR)
Bouchon fileté G avec six pans creux et joint
torique système Conovor (NBR)
Screw plug G locked with Allen key and
Conovor O-ring seal (NBR)

674

AD FE 40



Aufschraub-Winkel G
Coude femelle G
Female threaded elbow G

674

AD FT 40



Aufschraub-T G
Té femelle G
Female threaded tee G

674

SO 40511



Einschraubtülle R
Douille cannelée à visser R
Male adaptor hose nozzle R

675

SO 40511 NPT



Einschraubtülle NPT
Douille cannelée à visser NPT
Male adaptor hose nozzle NPT

675

**Messing chemisch
vernickelt**

Verschraubungen

























**Laiton avec
nickelage chimique**

Raccords

**Brass chemically
nickel-plated**

Unions



	Seite/Page/Page		Seite/Page/Page		Seite/Page/Page
Klemmring Bague de serrage Compression ferrule	125-126 	Schlauchtülle Douille cannelée Hose nozzle	133 	Winkelverschraubung Coude Elbow union	144-145 
	SO 80001		SO 80503		SO 82021
Abschlusszapfen Bouchon d'arrêt Plug	127 	Gerade Verschraubung Union double Straight union	134 	Winkel-Einschraubverschraubung Coude mâle Male adaptor elbow union	146 
	SO 80002		SO 81021		SO 82421
Stützhülse Douille d'appui Stiffener sleeve	128 	Gerade Einschraubverschraubung Union mâle Male adaptor union	135-138 	Einstellbare Winkelverschraubung Coude orientable Adjustable elbow union	147 
	SO 80003		SO 81121		SO 82621
Sechskantmutter METR Ecrou à six pans METR Hexagon nut METR	128 	Gerade Aufschraubverschraubung Union femelle Female adaptor union	139 	Winkel-Schottverschraubung Coude traversée de cloison Panel mount elbow union	148 
	SO 80006		SO 81221		SO 82721
Anschlussmutter Ecrou Union nut	129 	Verbindungsrippel Pièce folle Tube stub	140 	T-Verschraubung Té égal Tee union	149-150 
	SO 80020		SO 81300		SO 83021
Armaturenanschluss Ecrou et bague de raccordement Nut connection	130 	Gerade Schottverschraubung Union double traversée de cloison Panel mount union	141 	Einstellbare T-Verschraubung Té orientable au centre Adjustable tee union	151 
	SO 80021		SO 81521		SO 83621 T
Übergangsmuffe Adaptateur femelle Female adaptor	131 	Einstellnippel Adaptateur orientable mâle Adjustable male adaptor	142 	Einstellbare L-Verschraubung Té orientable en bout Adjustable L union	152 
	SO 80030		SO 81600		SO 83621 L
Übergangsrippel Adaptateur femelle - mâle Male adaptor	132 	Reduktionsverschraubung Union de réduction Reduction union	143 	T-Einschraubverschraubung Té mâle au centre Male adaptor Tee union	153 
	SO 80040		SO 81821		SO 83721 T

Sonderausführungen auf Anfrage
Exécution en option sur demande
Optional services on request



Spezialreinigung - entfettet
 Traitement spécial - dégraissé
 Special treatment - degreased



Spezialbehandlung für Einsatz mit Sauerstoff
 Traitement spécial pour utilisation sous oxygène
 Special treatment for use with oxygen



Spezialbehandlung - silikonfrei
 Traitement spécial - sans silicone
 Special treatment - silicone free



Vorbeschichtete Gewinde PTFE-Band umwickelt
 Filetages pré enduits avec ruban en PTFE
 Pre-coated threads with PTFE-tape



Vorbeschichtete Gewinde mit Loctite 5061
 Filetages pré enduits avec Loctite 5061
 Pre-coated threads with Loctite 5061

Alle Produkte aus dem Kapitel 1 sind auf Wunsch mit Aufpreis in chem. vernickelter Ausführung erhältlich.

Tous les produits du chapitre 1 sont aussi réalisables avec nickelage chimique moyennant un supplément.

All products in chapter 1 are available chemically nickel plated for an additional charge.

Bestätigungen auf www.serto.com
Confirmations sur www.serto.com
Confirmations on www.serto.com



Messing CV

Eigenschaften, Besonderheiten

- einfache, schnelle Montage
- kompakte Baumasse
- grosse Sortimentsvielfalt
- sehr viele Kombinationsmöglichkeiten

Funktionsprinzip

Siehe Kapitel i

Basis-Werkstoff

Messing CW617N (CuZn40Pb2)

Chemische Vernickelung

Nickel: 88 - 89,5 %
 Phosphor: 10,5 - 12 %
 Schmelzpunkt: ca. +880 °C
 Härtegrad: 450/500 Vickers

Schichtstärke

Generell: ca. 7 - 8 µm
 Ausnahme: Ventilspindeln ca. 2 - 3 µm

Betriebsdruck PN

Siehe Produkttabellen (4-fache Sicherheit)

Temperaturbereich

-196 °C bis +180 °C

Helium-Leckrate

10⁻⁸ mbar • l/s *

Vakuum

Bis 10⁻⁴ mbar, höhere Werte möglich

Anzuschliessende Edelstahlrohre

Nahtlose Präzisionsrohre aus Edelstahl (DIN EN 10216-5/EN ISO 1127) mit sauberer, glatter Oberfläche. Toleranz Aussendurchmesser ± 0.1 mm, Rohre Ø < 6 mm Toleranz ± 0.05 mm. Siehe auch Kapitel i und Kapitel 19.

Andere anzuschliessende Rohre

Kunststoffrohre und nahtlose, gezogene Kupferrohre (insbes. EN 12449/1057) mit sauberer, glatter Oberfläche. Toleranz Aussendurchmesser ± 0,1 mm; Ausnahme: Kunststoffrohre. Siehe auch Kapitel i und Kapitel 19. Weitere Materialien auf Anfrage.

Druckauswertungsgrad in % des PN



* bei fachgerechter Montage; siehe Kapitel i:
 - Montageanleitung
 - Rohrempfehlungen

Lation CV

Propriétés, spécificités

- montage facile et rapide
- compactes dimensions
- vaste gamme de produits
- multiples possibilités de combinaisons

Principe de fonctionnement

Voir chapitre i

Matériau de base

Laiton CW617N (CuZn40Pb2)

Nickelage chimique

Nickel: 88 - 89,5 %
 Phosphore: 10,5 - 12 %
 Point de fusion: ca. +880 °C
 Dureté: 450/500 Vickers

Épaisseur de la couche

Général: env. 7 - 8 µm
 Exception: tige du robinet env. 2 - 3 µm

Pression de service PN

Voir tableaux des produits (facteur de sécurité 4)

Plage de température admissible

-196 °C à +180 °C

Débit de fuite avec hélium

10⁻⁸ mbar • l/s *

Vide

Jusqu'à 10⁻⁴ mbar, valeurs plus élevées possible

Tubes en acier inoxydable à utiliser

Tubes en acier inoxydable sans soudure (selon DIN EN 10216-5/EN ISO 1127), avec surface propre et lisse. Tolérance du diamètre extérieur de ± 0.1 mm, tubes Ø < 6 mm tolerance ± 0.05 mm. Voir aussi chapitre i et chapitre 19.

Autres tubes à utiliser

Tubes en matière plastique et tous les tubes en cuivre sans soudure (selon EN 12449/1057) avec surface propre et lisse. Tolérance du diamètre extérieur de ± 0.1 mm; exception: tubes en plastique. Voir aussi chapitre i et chapitre 19 Autres matériaux sur demande.

Coefficient de pression de service admissible en % de PN

* à la base d'un montage dans les règles de l'art; voir chapitre i:
 - Instructions de montage
 - Recommandations pour tubes

Brass CV

Characteristics, specialities

- easy and fast to install
- compact dimensions
- extensive product range
- many combination possibilities

Operating principle

See chapter i

Basic material

Brass CW617N (CuZn40Pb2)

Chemical nickel-plating

Nickel: 88 - 89,5 %
 Phosphorus: 10,5 - 12 %
 Melting point: ca. +880 °C
 Degree of hardness: 450/500 Vickers

Thickness of the layer

Generally: ca. 7 - 8 µm
 Exception: valve spindles ca. 2 - 3 µm

Working pressure PN

See product tables (safety factor 4)

Temperature range

-196 °C to +180 °C

Leak rate with helium

10⁻⁸ mbar • l/s *

Vacuum

Up to 10⁻⁴ mbar, higher values are possible

Stainless steel tubes to use

Seamless stainless steel precision tubes (to DIN EN 10216-5/EN ISO 1127) with clean smooth surface. Tolerance of outside diameter ± 0.1 mm, tubes Ø < 6 mm tolerance ± 0.05 mm. See also chapter i and chapter 19.

Other tubes to use

Tubes of plastic and seamless copper tubes (esp. EN 12449/1057) with clean smooth surface. Tolerance of outside diameter ± 0.1 mm; exception: plastic tubes. See also chapter i and chapter 19. Further materials on request.

Pressure coefficient % of PN

* when professionally assembled; see chapter i:
 - Installation instructions
 - Recommendations for tubes

Klemmring
Bague de serrage
Compression ferrule

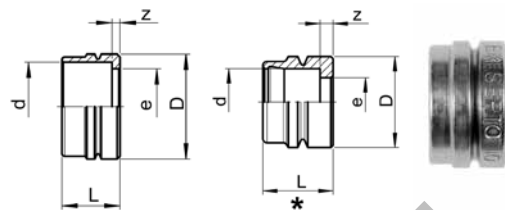

SO 80001

Type -d	Mat.-Nr.	bar	L	D	z	e	kg/100
SO 80001-4	036.0010.040	125	5.0	6.0	1.0	3.4	0.060
SO 80001-5	036.0010.050	125	5.5	6.8	1.0	4.0	0.060
SO 80001-6 *	036.0010.060	125	6.5	8.4	1.2	4.5	0.120
SO 80001-8 *	036.0010.080	80	7.0	10.4	1.2	6.5	0.170
SO 80001-10 *	036.0010.100	60	7.8	12.7	1.2	8.5	0.250
SO 80001-12 *	036.0010.120	40	8.8	14.7	1.2	10.0	0.330
SO 80001-15	036.0010.150	25	10.0	18.0	1.4	13.0	0.510
SO 80001-18	036.0010.180	25	11.7	22.0	1.4	16.0	0.910

2

KROVAVI

d=Rohraussen-ø
 e=kleinste Bohrung

d=ø extérieur du tube
 e=ø-min. de passage

d=tube outside diameter
 e=minimum bore

Klemmring reduziert

Bague de serrage de réduction

Reduction compression ferrule

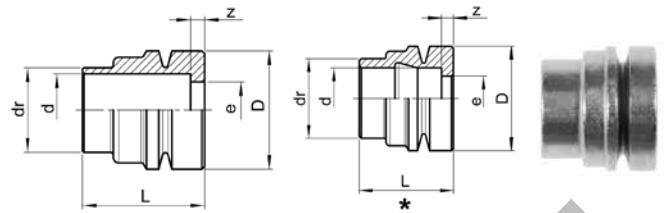

SO 80001 RED

Type-dr-d	Mat.-Nr.	bar	L	D	z	e	kg/100
SO 80001-6-4	036.0014.110	125	8.5	8.4	1.0	3.4	0.230
SO 80001-8-6 *	036.0014.140	125	9.5	10.5	1.2	4.5	0.330
SO 80001-10-8 *	036.0014.190	80	11.5	12.7	1.2	6.5	0.450
SO 80001-12-10 *	036.0014.240	60	12.5	14.7	1.2	8.5	0.610
SO 80001-15-12	036.0014.420	40	14.0	18.0	1.4	10.0	1.050
SO 80001-18-15	036.0014.610	25	15.7	22.0	1.4	13.0	1.660

Anwendungsbeispiele:

Exemples d'utilisation:

Sample combinations:

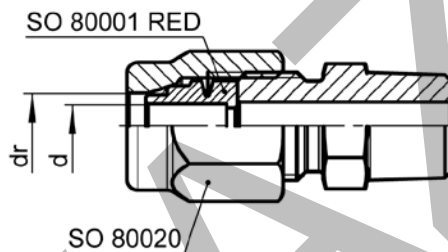

Einstufige Reduktionen von Rohranschlüssen sind auf einfachste Art durch Auswechseln der normalen gegen die reduzierten Klemmringe möglich.

Beispiel:

Reduktion eines Rohranschlusses 15 mm auf 12 mm:
Klemmring SO 80001-15 austauschen gegen SO 80001-15-12 RED. Anschlussmutter SO 80020-15 bleibt.

Les réductions à une étape des raccords sont disponibles de manière simple en remplaçant la normale par rapport aux bagues de serrage réduites.

Exemple:

Réduction d'un raccord 15 mm sur 12 mm:
Bague de serrage SO 80001-15 en échange de SO 80001-15-12 RED. L'écrou SO 80020-15 reste.

Single stage reductions for tube connections can be simply achieved by replacing the normal compression ferrule with reduced compression ferrules.

Example:

Reduction of a tube connection 15 mm to 12 mm:
Replace compression ferrule SO 80001-15 with SO 80001-15-12 RED. The SO 80020-15 union nut remains.

Abschlusszapfen
Bouchon d'arrêt
Plug

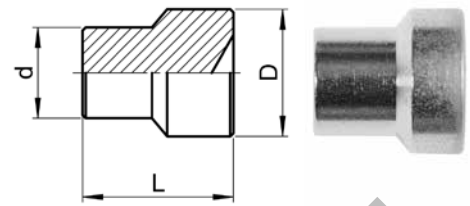

SO 80002

Type -d	Mat.-Nr.	L	D	kg/100
SO 80002-6	036.0020.060	10.0	8.4	0.310
SO 80002-8	036.0020.080	10.5	10.5	0.570
SO 80002-10	036.0020.100	13.0	12.7	0.960
SO 80002-12	036.0020.120	14.0	14.8	1.470
SO 80002-14/15	036.0020.150	15.0	18.0	2.370
SO 80002-17/18	036.0020.180	16.8	22.0	4.000
SO 80002-6,35	036.0020.063	10.0	8.4	0.310

Umrechnung für "d" bei Zollrohren:
6,35 = 1/4

Conversion de "d" pour tubes en pouces:
6,35 = 1/4

Conversion for "d" for inch tubes:
6,35 = 1/4

Anwendungsbeispiele:

Exemples d'utilisation:

Sample combinations:

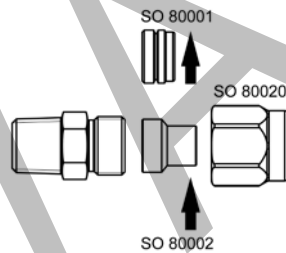

Der Abschlusszapfen lässt sich in jede Verschraubung anstelle eines Klemmringes der gleichen Größe einsetzen. Wird ein reduzierter Klemmring durch einen Abschlusszapfen ersetzt, so muss immer von der Größe der Anschlussmutter ausgegangen werden.

Le bouchon d'arrêt s'insère dans tout raccord au lieu d'une bague de serrage de la même taille. Si une bague de serrage de réduction est remplacée par un bouchon d'arrêt, la taille de l'écrou de raccordement doit toujours être prise en compte.

The plug can be inserted into all unions instead of a compression ferrule of the same size. If a reduction compression ferrule is replaced by a plug, the size of the union nut must be used as a basis.

Montagehinweis: Anschlussmutter mit 1/4 Umdrehung anziehen.

Note d'installation: Serrez l'écrou d'accouplement de 1/4 de tour.

Assembly information: Tighten the union nut with 1/4 turn.

Stützhülse

zur Rohrverstärkung

Douille d'appui

pour renforcer les tubes

Stiffener sleeve

to reinforce tubes

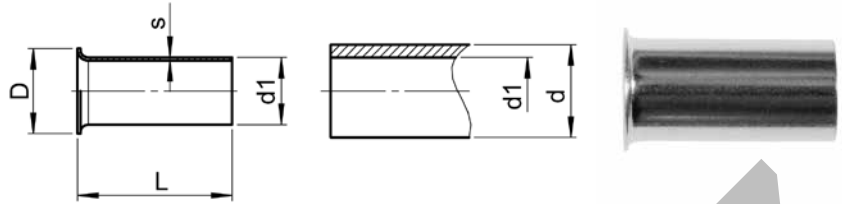

SO 80003

Type -d-d1	Mat.-Nr.	L	D	s	kg/100
SO 80003-6-4	036.0030.110	10.0	5.5	0.20	0.025
SO 80003-8-6	036.0030.140	12.0	7.5	0.25	0.045
SO 80003-10-8 D	036.0030.189	16.0	9.5	0.60	0.190
SO 80003-10-8	036.0030.190	16.0	9.5	0.30	0.100
SO 80003-12-10	036.0030.240	20.0	11.5	0.40	0.195
SO 80003-15-13	036.0030.430	24.0	14.5	0.50	0.390
SO 80003-17-15	036.0030.610	26.0	16.5	0.60	0.590
SO 80003-18-15	036.0030.540	26.0	16.5	0.60	0.590

Werkstoff: Messing CW508L chem. vernickelt

Matériau: Laiton CW508L nick. chim.

Material: Brass CW508L chem. nickel-plated

Verstärken:

Dünnwandige und weiche Rohre sowie alle Kunststoffrohre sind mit Stützhülsen zu verstärken.

Genauere Angaben über das Verstärken siehe Kapitel i.

Hilfswerkzeuge zum Entgraten und Kalibrieren der Rohre siehe Kapitel 21.

Renforcement:

Tubes à paroi mince et tubes souples ainsi que tubes en plastique doivent être renforcés à l'aide de douilles d'appui.

Pour des indications concernant le renforcement voir chapitre i.

Pour des outils pour l'ébarbage et le calibrage du tube voir chapitre 21.

Reinforcement:

Thin walled, soft tubes and all plastic tubes are to be reinforced with stiffener sleeves.

Details concerning stiffening are to be found in chapter i.

For useful tools for deburring and calibrating tubes see chapter 21.

Typenbezeichnung mit D: für weiches oder sehr dünnwandiges Kupferrohr.

Types avec D: pour des tubes de cuivre mous ou à parois très minces.

Types with D: for soft or very thin-walled copper tubes.

Sechskantmutter METR

Ecrou à six pans METR

Hexagon nut METR

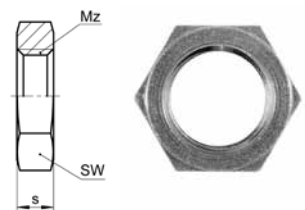

SO 80006 METR

Type -Mz	Mat.-Nr.	SW	s	kg/100
Mz=metrisches Gewinde (zylindrisch)	Mz=Filetage métrique (cylindrique)	Mz=Metric thread (parallel)		
SO 80006-M10x1	036.0063.150	14	4.00	0.310
SO 80006-M12x1	036.0063.190	17	4.00	0.460
SO 80006-M14x1	036.0063.220	19	4.00	0.530
SO 80006-M16x1	036.0063.260	19	4.00	0.380
SO 80006-M20x1	036.0063.340	24	4.50	0.690
SO 80006-M20x1,5	036.0063.345	27	6.00	1.640
SO 80006-M24x1,5	036.0063.405	27	7.00	1.140

Sechskantmutter für SO 81521 und SO 82721.

Ecrou à six pans pour SO 81521 et SO 82721.

Hexagon nut for 81521 and SO 82721.

d=Rohraussen- \varnothing
d1=Rohrinnen- \varnothing
s=Wandstärke

d= \varnothing extérieur du tube
d1= \varnothing intérieur du tube
s=épaisseur de la paroi

d=tube outside diameter
d1=tube inside diameter
s=wall thickness

Anschlussmutter

Ecrou

Union nut

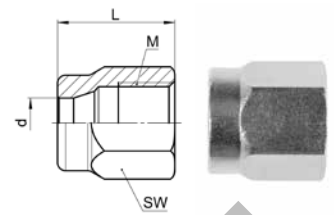

SO 80020

Type -d	Mat.-Nr.	bar	M	SW	L	kg/100
SO 80020-6	036.0200.060	125	10x1.0	12	14.5	0.740
SO 80020-8	036.0200.080	80	12x1.0	14	16.0	0.990
SO 80020-10	036.0200.100	60	14x1.0	17	18.5	1.770
SO 80020-12	036.0200.120	40	16x1.0	19	20.0	2.170
SO 80020-15	036.0200.150	25	20x1.5	24	21.5	3.910
SO 80020-18	036.0200.180	25	24x1.5	27	24.0	4.370

2

KROVAVAZI

Armaturenanschluss

Ecrou et bague de raccordement

Nut connection

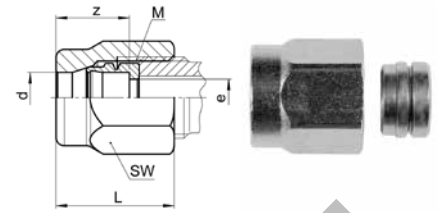

SO 80021

Type -d	Mat.-Nr.	bar	M	SW	L	z	e	kg/100
SO 80021-6	036.0210.060	125	10x1.0	12	14.5	7.5	4.5	0.840
SO 80021-8	036.0210.080	80	12x1.0	14	16.0	8.0	6.5	1.120
SO 80021-10	036.0210.100	60	14x1.0	17	18.5	10.0	8.5	1.890
SO 80021-12	036.0210.120	40	16x1.0	19	20.0	11.0	10.0	2.340
SO 80021-15	036.0210.150	25	20x1.5	24	21.5	12.5	13.0	4.240
SO 80021-18	036.0210.180	25	24x1.5	27	24.0	14.0	16.0	5.260

Armaturenanschluss reduziert

Ecrou et bague de raccordement réduite

Reduction nut connection

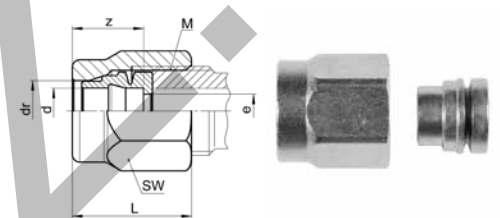

SO 80021 RED

Type -dr -d	Mat.-Nr.	bar	M	SW	L	z	e	kg/100
SO 80021-6-4	036.0214.110	125	10x1.0	12	14.5	7.5	3.4	0.950
SO 80021-8-6	036.0214.140	125	12x1.0	14	16.0	8.0	4.5	1.280
SO 80021-10-8	036.0214.190	80	14x1.0	17	18.5	10.0	6.5	2.090
SO 80021-12-10	036.0214.240	60	16x1.0	19	20.0	11.0	8.5	2.620
SO 80021-15-12	036.0214.420	40	20x1.5	24	21.5	12.5	10.0	4.780
SO 80021-18-15	036.0214.610	25	24x1.5	27	24.0	14.0	13.0	6.010

Anwendungsbeispiele:

Exemples d'utilisation:

Sample combinations:

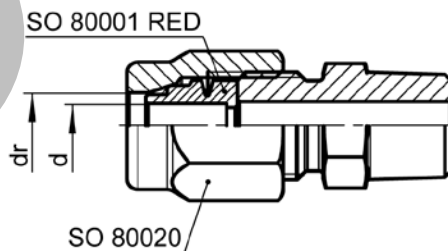

Mit diesem Armaturenanschluss können einstufige Reduktionen vorgenommen werden. Die Anschlussgewindegrößen sind im Kapitel i aufgeführt.

Avec cet écrou de raccordement, les réductions à une étape peuvent être faites. Les tailles des filets sont listées dans le chapitre i.

Single stage reductions can be made with this nut connection. The connecting threads are listed in chapter i.

Übergangsmuffe Adaptateur femelle Female adaptor

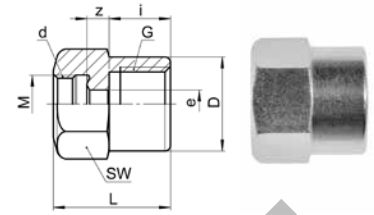

SO 80030

Type -d-G	Mat.-Nr.	bar	M	SW	L	D	i	z	e	kg/100
G=Rohrgewinde (zylindrisch)	G=Filetage-gaz BSP (cylindrique)	G=BSP thread (parallel)								
SO 80030-6-1/8	036.0301.100	125	10x1.0	14	20.0	13.8	10.0	4.0	5.0	1.670
SO 80030-6-1/4	036.0301.110	125	10x1.0	17	21.0	16.8	11.0	4.0	5.0	2.530
SO 80030-8-1/8	036.0301.160	80	12x1.0	17	21.0	16.8	10.0	4.0	6.5	2.790
SO 80030-8-1/4	036.0301.170	80	12x1.0	17	23.0	16.8	11.0	5.0	6.5	2.540
SO 80030-10-1/4	036.0301.270	60	14x1.0	17	22.0	16.8	11.0	4.0	8.5	2.090
SO 80030-10-3/8	036.0301.280	60	14x1.0	22	23.0	21.8	12.0	5.0	8.5	4.760
SO 80030-12-3/8	036.0301.390	40	16x1.0	22	23.0	21.8	12.0	4.0	10.5	4.090
SO 80030-12-1/2	036.0301.400	40	16x1.0	27	25.0	26.8	14.0	4.0	10.5	7.270
SO 80030-15-3/8	036.0301.532	25	20x1.5	24	25.0	23.8	12.0	5.0	13.0	5.140
SO 80030-15-1/2	036.0301.534	25	20x1.5	27	27.0	26.8	14.0	5.0	13.0	7.130
SO 80030-18-1/2	036.0301.646	25	24x1.5	30	28.0	29.8	14.0	6.0	15.0	9.410
SO 80030-18-3/4	036.0301.648	25	24x1.5	32	31.0	31.8	17.0	6.0	15.0	10.350

2

Anwendungsbeispiele:

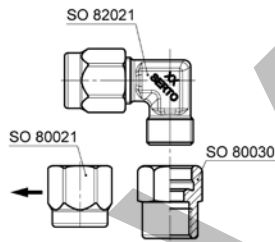

Die Übergangsmuffe kann auf jedes SERTO-Formteil mit dem passenden zylindrischen Gewinde geschraubt werden und muss mit 1/4 Umdrehung angezogen werden.

Dichtungsprinzip: Bei der Montage drückt sich die Dichtkante des Übergangsstückes in das SERTO-Formteil ein, dadurch entsteht eine einwandfreie Dichtung. Wir empfehlen, das Gewinde mit einem geeigneten Flüssigklebstoff gegen unbeabsichtigtes Lösen zu sichern.

Exemples d'utilisation:

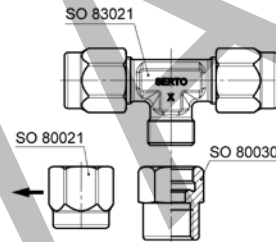

L'adaptateur femelle peut être vissé à toute pièce moulée SERTO avec le filetage cylindrique approprié et doit être serré de 1/4 de tour.

Principe d'étanchéité: Lors de l'assemblage, l'arête d'étanchéité de l'adaptateur appuie sur la pièce moulée SERTO, créant ainsi une étanchéité parfaite. Nous recommandons de fixer le filetage avec une colle liquide appropriée pour empêcher le desserrage involontaire.

Sample combinations:

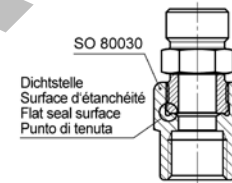

The female adaptor can be screwed onto all SERTO moulded parts with a matching cylindrical thread and must be tightened with 1/4 turn.

Sealing principle: During assembly, the sealing edge of the female adaptor presses into the SERTO moulded part to produce a perfect seal. We recommend that the thread is secured against accidental unscrewing by means of a suitable liquid adhesive.

Übergangsnippel

Adaptateur femelle - mâle

Male adaptor

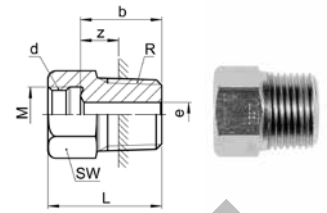

SO 80040

Type -d -R	Mat.-Nr.	bar	M	SW	L	b	z	e	kg/100
R=Rohrgewinde (kegelig)	R=Filetage-gaz BSP (conique)	R=BSP thread (tapered)							
SO 80040-6-1/8	036.0401.100	125	10x1.0	12	17.0	11.0	6.0	5.0	0.800
SO 80040-6-1/4	036.0401.110	125	10x1.0	14	21.0	15.0	7.0	5.0	1.850
SO 80040-6-3/8	036.0401.120	125	10x1.0	17	20.0	14.0	6.0	5.0	2.440
SO 80040-8-1/8	036.0401.160	80	12x1.0	14	18.0	11.0	6.0	6.5	0.990
SO 80040-8-1/4	036.0401.170	80	12x1.0	14	22.0	15.0	7.0	6.5	1.520
SO 80040-10-1/4	036.0401.270	60	14x1.0	17	22.0	15.0	7.0	8.5	1.710
SO 80040-10-3/8	036.0401.280	60	14x1.0	17	22.0	15.0	7.0	8.5	2.440
SO 80040-10-1/2	036.0401.285	60	14x1.0	22	23.0	16.0	6.0	8.5	5.030
SO 80040-12-1/4	036.0401.380	40	16x1.0	19	23.0	16.0	8.0	8.5	2.110
SO 80040-12-3/8	036.0401.390	40	16x1.0	19	23.0	16.0	8.0	10.5	2.870
SO 80040-12-1/2	036.0401.400	40	16x1.0	22	26.0	19.0	9.0	10.5	4.840
SO 80040-15-3/8	036.0401.532	25	20x1.5	24	24.0	16.0	8.0	10.5	3.760
SO 80040-15-1/2	036.0401.534	25	20x1.5	24	28.0	20.0	10.0	13.0	4.430
SO 80040-15-3/4	036.0401.536	25	20x1.5	27	27.5	19.5	7.5	13.0	8.250
SO 80040-18-1/2	036.0401.646	25	24x1.5	30	29.0	21.0	11.0	13.0	6.010
SO 80040-18-3/4	036.0401.648	25	24x1.5	30	29.5	21.5	9.5	15.0	8.930

Anwendungsbeispiele:

Exemples d'utilisation:

Sample combinations:

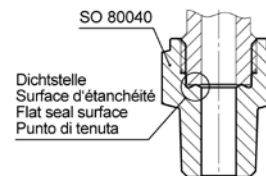
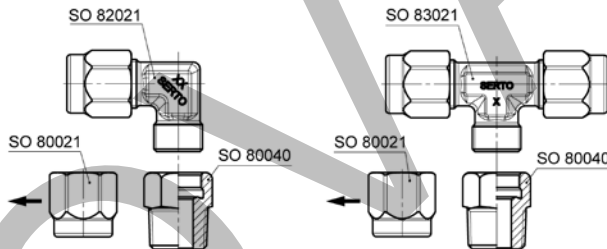

Der Übergangsnippel kann auf jedes SERTO-Formteil mit dem passenden zylindrischen Gewinde geschraubt werden und muss mit 1/4 Umdrehung angezogen werden.

Dichtungsprinzip: Bei der Montage drückt sich die Dichtkante des Übergangsstückes in das SERTO-Formteil ein, dadurch entsteht eine einwandfreie Dichtung. Wir empfehlen, das Gewinde mit einem geeigneten Flüssigklebstoff gegen unbeabsichtigtes Lösen zu sichern.

L'adaptateur mâle peut être vissé à toute pièce moulée SERTO avec le filetage cylindrique approprié et doit être serré de 1/4 de tour.

Principe d'étanchéité: Lors de l'assemblage, l'arête d'étanchéité de l'adaptateur appuie sur la pièce moulée SERTO, créant ainsi une étanchéité parfaite. Nous recommandons de fixer le filetage avec une colle liquide appropriée pour empêcher le desserrage involontaire.

The male adaptor can be screwed onto all SERTO moulded parts with a matching cylindrical thread and must be tightened with 1/4 turn.

Sealing principle: During assembly, the sealing edge of the male adaptor presses into the SERTO moulded part to produce a perfect seal. We recommend that the thread is secured against accidental unscrewing by means of a suitable liquid adhesive.

Schlauchtülle

Douille cannelée

Hose nozzle

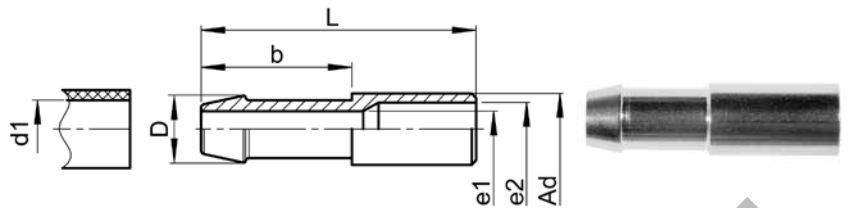

SO 80503

Type-Ad-d1	Mat.-Nr.	L	D	b	e1	e2	kg/100
SO 80503-A6-4	036.0500.110	25.0	5.0	11.0	3.0	4.0	0.270
SO 80503-A6-6	036.0500.122	31.0	7.5	17.0	4.0	4.0	0.480
SO 80503-A6-8	036.0500.121	31.0	9.5	17.0	4.0	4.0	0.804
SO 80503-A8-6	036.0500.140	31.0	7.5	17.0	5.0	6.0	0.520
SO 80503-A8-8	036.0500.154	31.0	9.5	17.0	6.0	6.0	0.710
SO 80503-A10-8	036.0500.190	35.0	9.5	17.0	6.0	8.0	0.720
SO 80503-A10-10	036.0500.198	37.0	11.5	19.0	8.0	8.0	1.370
SO 80503-A12-10	036.0500.240	37.0	11.5	19.0	8.0	9.0	1.230
SO 80503-A12-13	036.0500.260	39.0	15.0	21.0	9.0	9.0	2.889
SO 80503-A15-13	036.0500.430	41.0	15.0	21.0	12.0	12.0	2.050
SO 80503-A18-16	036.0500.620	47.0	18.0	26.0	13.0	15.0	3.240

Anwendungsbeispiele:

Exemples d'utilisation:

Sample combinations:

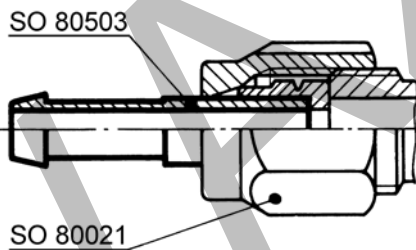

Mit dieser Schlauchtülle können Schläuche und Rohre aus Kunststoff wie z.B. PTFE, PVDF, Polyamid usw. direkt an SERTO-Verschraubungen angeschlossen werden.
Für die Schlauchsicherung verwenden Sie bitte Schlauchklemme SO 40512 (siehe Kapitel 21).

Avec ce douille cannelée, les tuyaux et les tubes en plastique comme p.ex. PTFE, PVDF, polyamide, etc. peuvent être branchés directement au raccord fileté SERTO.
Pour fixer le tuyau, utilisez le collier de serrage SO 40512 (voir chapitre 21).

With this hose nozzle, hoses and tubes made of plastic, e.g. PTFE, PVDF, polyamide etc. can be connected directly to SERTO unions.
To secure the hose, use the SO 40512 hose clamp (see chapter 21).

Gerade Verschraubung Union double Straight union

SO 81021

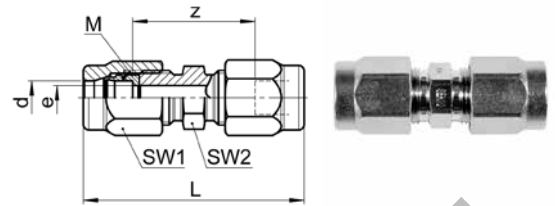

Type -d	Mat.-Nr.	bar	M	SW1	SW2	L	z	e	kg/100
SO 81021-6	038.1020.060	125	10x1.0	12	10	37.5	22.0	4.5	2.520
SO 81021-8	038.1020.080	80	12x1.0	14	12	41.0	25.0	6.5	3.530
SO 81021-10	038.1020.100	60	14x1.0	17	14	46.0	26.0	8.5	5.490
SO 81021-12	038.1020.120	40	16x1.0	19	17	48.5	26.5	10.0	7.030
SO 81021-15	038.1020.150	25	20x1.5	24	22	57.0	32.0	13.0	12.520
SO 81021-18	038.1020.180	25	24x1.5	27	24	61.0	33.0	15.0	15.810

Gerade Verschraubung reduziert Union double réduite Straight reduction union

SO 81021 RED

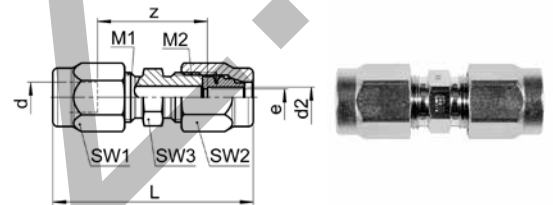

Type -d-d2	Mat.-Nr.	bar	M1	M2	SW1	SW2	SW3	L	z	e	kg/100
* SO 81021-6-4	038.1024.110	125	10x1.0	10x1.0	12	12	10	37.5	22.5	3.4	2.630
SO 81021-8-6	038.1024.140	125	12x1.0	10x1.0	14	12	12	39.5	24.0	4.5	3.400
* SO 81021-10-8	038.1024.190	80	14x1.0	14x1.0	17	17	14	46.0	26.5	6.5	5.690
* SO 81021-12-10	038.1024.240	60	16x1.0	16x1.0	19	19	17	48.5	30.0	8.5	7.310
* SO 81021-15-12	038.1024.420	40	20x1.5	20x1.5	24	24	22	57.0	32.0	10.0	13.060
* SO 81021-18-15	038.1024.610	25	24x1.5	24x1.5	27	27	24	61.0	33.0	13.0	16.560

Weitere Reduktionen siehe SO 81821

Autres réductions voir SO 81821

Alternative reductions see SO 81821

d=Rohrassen- \varnothing
 e=kleinste Bohrung
 L=Mass in montiertem Zustand
 *=mit reduziertem Klemmring

d= \varnothing extérieur du tube
 e= \varnothing -min. de passage
 L=après montage
 *=avec bague de serrage de réduction

d=tube outside diameter
 e=minimum bore
 L=installed length
 *=with reduction compression ferrule

Gerade Einschraubverschraubung

Union mâle

Male adaptor union

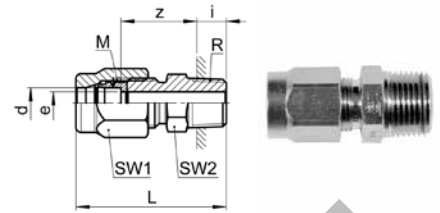

SO 81121

Type -d-R	Mat.-Nr.	bar	M	SW1	SW2	L	i	z	e	kg/100
Für metrische Rohre R=Rohrgewinde (kegelig)	Pour tubes métriques R=Filetage-gaz BSP (conique)			For metric tubes R=BSP thread (tapered)						
SO 81121-4-1/8	038.1101.060	125	8x1.0	10	10	27.0	5.0	16.0	3.4	1.410
* SO 81121-4-1/4	038.1101.065	125	10x1.0	12	14	34.0	8.0	18.5	3.4	2.930
SO 81121-6-1/8	038.1101.100	125	10x1.0	12	10	28.5	5.0	16.0	4.5	1.690
SO 81121-6-1/4	038.1101.110	125	10x1.0	12	14	34.5	8.0	18.5	4.5	2.820
SO 81121-6-3/8	038.1101.120	125	10x1.0	12	17	34.5	8.0	19.0	4.5	3.390
SO 81121-8-1/8	038.1101.160	80	12x1.0	14	12	30.5	5.0	17.5	6.0	2.260
SO 81121-8-1/4	038.1101.170	80	12x1.0	14	14	35.5	8.0	19.5	6.5	3.110
SO 81121-8-3/8	038.1101.180	80	12x1.0	14	17	36.0	8.0	20.0	6.5	3.730
SO 81121-8-1/2	038.1101.185	80	12x1.0	14	22	41.0	10.0	23.0	6.5	6.040
SO 81121-10-1/4	038.1101.270	60	14x1.0	17	14	37.5	8.0	19.5	8.5	3.630
SO 81121-10-3/8	038.1101.280	60	14x1.0	17	17	38.0	8.0	20.0	8.5	4.830
SO 81121-10-1/2	038.1101.285	60	14x1.0	17	22	43.0	10.0	23.0	8.5	8.040
SO 81121-12-1/4	038.1101.380	40	16x1.0	19	17	39.0	8.0	20.0	8.5	4.820
SO 81121-12-3/8	038.1101.390	40	16x1.0	19	17	39.0	8.0	20.0	10.0	5.110
SO 81121-12-1/2	038.1101.400	40	16x1.0	19	22	44.0	10.0	23.0	10.0	7.760
SO 81121-15-3/8	038.1101.532	25	20x1.5	24	22	44.0	8.0	23.5	10.5	8.820
SO 81121-15-1/2	038.1101.534	25	20x1.5	24	22	48.0	10.0	25.5	13.0	9.110
SO 81121-15-3/4	038.1101.536	25	20x1.5	24	27	49.0	12.0	24.5	13.0	10.650
SO 81121-18-1/2	038.1101.646	25	24x1.5	27	24	50.5	10.0	26.5	15.0	10.760

Für Zollrohre

Pour tubes pouces

For inch tubes

SO 81121-6,35-1/8	038.1101.135	125	10x1.0	12	10	28.5	5.0	16.0	4.5	1.680
-------------------	--------------	-----	--------	----	----	------	-----	------	-----	-------

 Umrechnung für "d" bei Zollrohren:
 6,35 = 1/4

 Conversion de "d" pour tubes en pouces:
 6,35 = 1/4

 Conversion for "d" for inch tubes:
 6,35 = 1/4

d=Rohrassen-ø
 e=kleinste Bohrung
 L=Mass in montiertem Zustand
 *=mit reduziertem Klemmring

d=ø extérieur du tube
 e=ø-min. de passage
 L=après montage
 *=avec bague de serrage de réduction

d=tube outside diameter
 e=minimum bore
 L=installed length
 *=with reduction compression ferrule

Gerade Einschraubverschraubung

mit Dichtkante

Union mâle

avec arête d'étanchéité

Male adaptor union

with edge seal

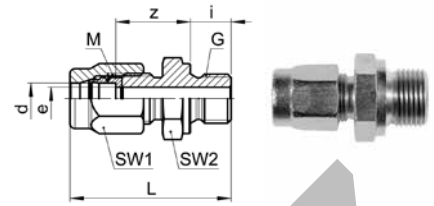

SO 81124

Type -d-G	Mat.-Nr.	bar	M	SW1	SW2	L	D	i	t	z	e	kg/100
G=Rohrgewinde (zylindrisch)	G=Filetage-gaz BSP (cylindrique)	G=BSP thread (parallel)										
SO 81124-3-1/8	038.1141.040	125	6x0.75	8	14	25.0	14.5	8.0	1.0	12.0	2.5	1.400
SO 81124-4-1/8	038.1141.060	125	8x1.0	10	14	28.5	14.5	8.0	1.0	14.5	3.4	1.820
* SO 81124-4-1/4	038.1141.065	125	10x1.0	12	19	35.5	18.5	8.0	1.5	16.0	3.4	3.840
SO 81124-5-1/8	038.1141.082	125	8x1.0	10	14	29.0	14.5	8.0	1.0	14.5	3.5	1.790
SO 81124-6-1/8	038.1141.100	125	10x1.0	12	14	30.0	14.5	8.0	1.0	14.5	4.5	2.070
SO 81124-6-1/4	038.1141.110	125	10x1.0	12	19	35.5	18.5	12.0	1.5	16.0	4.5	3.730
SO 81124-8-1/8	038.1141.160	80	12x1.0	14	14	31.5	14.5	8.0	1.0	15.5	4.5	2.830
SO 81124-8-1/4	038.1141.170	80	12x1.0	14	19	37.0	18.5	12.0	1.5	17.0	6.5	3.860
SO 81124-8-3/8	038.1141.180	80	12x1.0	14	22	38.5	22.5	12.0	2.0	18.5	6.5	5.720
SO 81124-10-1/4	038.1141.270	60	14x1.0	17	19	39.0	18.5	12.0	1.5	17.0	7.0	4.860
SO 81124-10-3/8	038.1141.280	60	14x1.0	17	22	40.5	22.5	12.0	2.0	18.5	8.5	6.250
SO 81124-12-1/4	038.1141.380	40	16x1.0	19	19	40.0	18.5	12.0	1.5	17.0	7.0	5.800
SO 81124-12-3/8	038.1141.390	40	16x1.0	19	22	41.5	22.5	12.0	2.0	18.5	10.0	6.500
SO 81124-12-1/2	038.1141.400	40	16x1.0	19	27	45.0	27.0	14.0	2.5	20.0	10.0	7.200

Gerade Einschraubverschraubung METR

mit Dichtkante

Union mâle METR

avec arête d'étanchéité

Male adaptor union METR

with edge seal

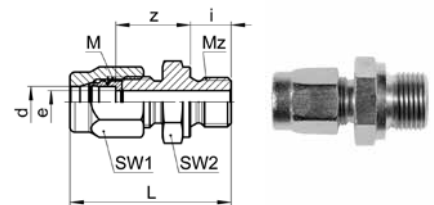

SO 81124 METR

Type -d-Mz	Mat.-Nr.	bar	M	SW1	SW2	L	D	i	t	z	e	kg/100
Mz=metrisches Gewinde (zylindrisch)	Mz=Filetage métrique (cylindrique)	Mz=Metric thread (parallel)										
SO 81124-2-M5	038.1143.020	125	6x0.75	8	8	18.0	10.0	4.5	0.5	9.5	1.5	0.500
SO 81124-3-M5	038.1143.050	125	6x0.75	8	8	20.0	10.0	4.5	0.5	10.0	2.2	0.540
SO 81124-4-M8x1	038.1143.090	125	8x1.0	10	12	29.0	12.5	8.0	1.0	15.0	3.4	1.530
SO 81124-6-M10x1	038.1143.180	125	10x1.0	12	14	30.5	14.5	8.0	1.0	14.5	4.5	1.380
SO 81124-8-M12x1,5	038.1143.240	80	12x1.0	14	17	37.5	17.5	12.0	1.5	17.0	6.0	3.600

Fortsetzung nächste Seite

Suite à la prochaine page

Continued on next page

d=Rohrassen-ø
e=kleinste Bohrung
L=Mass in montiertem Zustand
*=mit reduziertem Klemmring

d=ø extérieur du tube
e=ø-min. de passage
L=après montage
*=avec bague de serrage de réduction

d=tube outside diameter
e=minimum bore
L=installed length
*=with reduction compression ferrule

Einbauempfehlung:

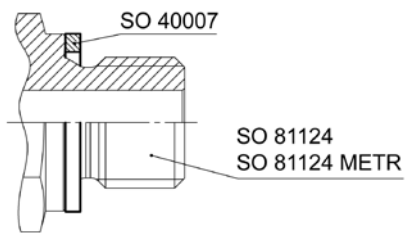

Bei Bedarf ist die entsprechende Dichtung SO 40007 / SO 40507 separat zu bestellen. Empfohlen für Größe M5.

Conseil de montage:

Si nécessaire, le joint correspondant SO 40007 / SO 40507 doit être commandé séparément. Recommandé pour taille M5.

Recommendation for installation:

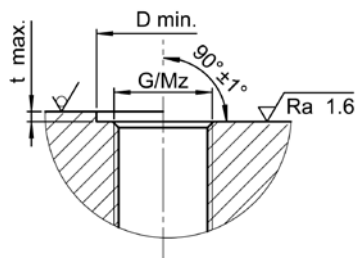

If necessary, the matching washers SO 40007 / SO 40507 must be ordered separately. Recommended for size M5.



KROVAVANZ

d=Rohrassens-ø
e=kleinste Bohrung
L=Mass in montiertem Zustand
*=mit reduziertem Klemmring

d=ø extérieur du tube
e=ø-min. de passage
L=après montage
*=avec bague de serrage de réduction

d=tube outside diameter
e=minimum bore
L=installed length
*=with reduction compression ferrule

Gerade Einschraubverschraubung

mit Conovor O-Ringabdichtung (NBR)

Union mâle

avec joint torique système Conovor (NBR)

Male adaptor union

with Conovor O-ring seal (NBR)

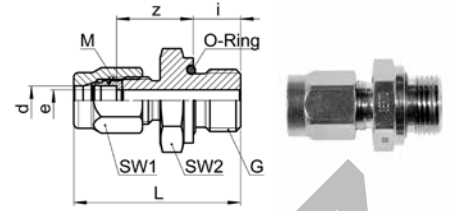

SO 81124 OR

Type -d-G	Mat.-Nr.	bar	M	SW1	SW2	L	D	i	t	O-Ring	z	e	kg/100
G=Rohrgewinde (zylindrisch)	G=Filetage-gaz BSP (cylindrique)	G=BSP thread (parallel)											
* SO 81124-4-1/8 OR	038.1171.060	125	10x1.0	12	14	30.0	14.5	8.0	1.0	8.73x1.78	14.5	3.4	2.300
* SO 81124-4-1/4 OR	038.1171.065	125	10x1.0	12	19	33.5	18.5	10.0	1.5	11.1x1.78	16.0	3.4	3.900
SO 81124-5-1/8 OR	038.1171.082	125	10x1.0	12	14	30.0	14.5	8.0	1.0	8.73x1.78	14.5	4.0	2.200
SO 81124-6-1/8 OR	038.1171.100	125	10x1.0	12	14	30.0	14.5	8.0	1.0	8.73x1.78	14.5	4.5	2.000
SO 81124-6-1/4 OR	038.1171.110	125	10x1.0	12	19	33.5	18.5	10.0	1.5	11.1x1.78	16.0	4.5	3.900
SO 81124-8-1/4 OR	038.1171.170	80	12x1.0	14	19	35.0	18.5	10.0	1.5	11.1x1.78	17.0	6.5	4.000
* SO 81124-8-3/8 OR	038.1171.180	80	14x1.0	17	22	38.5	22.5	10.0	2.0	14.0x1.78	18.5	6.5	6.400
SO 81124-10-1/4 OR	038.1171.270	60	14x1.0	17	19	37.0	18.5	10.0	1.5	11.1x1.78	17.0	6.5	4.700
SO 81124-10-3/8 OR	038.1171.280	60	14x1.0	17	22	38.5	22.5	10.0	2.0	14.0x1.78	18.5	8.5	6.200
SO 81124-12-3/8 OR	038.1171.390	40	16x1.0	19	22	39.5	22.5	10.0	2.0	14.0x1.78	18.5	10.0	6.300
SO 81124-12-1/2 OR	038.1171.400	40	16x1.0	19	27	42.0	27.0	12.0	2.5	18.72x2.62	19.0	10.0	7.700
SO 81124-15-1/2 OR	038.1171.534	25	20x1.5	24	27	46.0	27.0	12.0	2.5	18.72x2.62	21.5	13.0	13.500
SO 81124-18-1/2 OR	038.1171.646	25	24x1.5	27	27	47.5	27.0	12.0	2.5	18.72x2.62	21.5	13.0	15.300

Einbauempfehlung:

Conseil de montage:

Recommendation for installation:

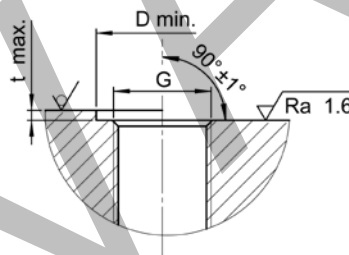

Einsatztemperaturbereich: -30 °C bis +100 °C

Plage de température de service: -30 °C à +100 °C

Operating temperature range: -30 °C to +100 °C

Die Vorteile dieser O-Ringabdichtung:

- keine Dichtmittelreste in Geräten
- einwandfreie Abdichtung
- keine Beschädigung von Geräten durch konische Gewinde
- schnelle Montage

Les avantages de cette étanchéité à joint torique:

- aucun reste de scellant dans les équipements
- une étanchéité parfaite
- aucun endommagement de l'équipement par le filetage conique
- facilité d'installation

Advantages of this O-ring seal:

- no sealing residues in devices
- perfect seal
- no damage to devices due to tapered thread
- rapid assembly

Conovor patentierte O-Ring Abdichtung

Etanchéité à joint torique brevetée Conovor

Conovor patented O-ring seal

d=Rohrassen-ø
e=kleinste Bohrung
L=Mass in montiertem Zustand
*=mit reduziertem Klemmring

d=ø extérieur du tube
e=ø-min. de passage
L=après montage
*=avec bague de serrage de reduction

d=tube outside diameter
e=minimum bore
L=installed length
*=with reduction compression ferrule

Gerade Aufschraubverschraubung

Union femelle

Female adaptor union

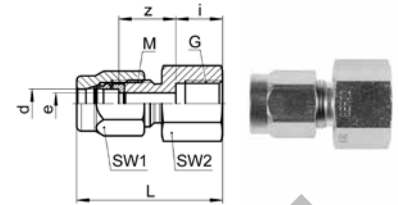

SO 81221

Type -d-G	Mat.-Nr.	bar	M	SW1	SW2	L	i	z	e	kg/100
G=Rohrgewinde (zylindrisch)	G=Filetage-gaz BSP (cylindrique)	G=BSP thread (parallel)								
* SO 81221-4-1/4	038.1201.065	125	10x1.0	12	17	31.5	11.0	13.0	3.4	3.110
SO 81221-6-1/8	038.1201.100	125	10x1.0	12	14	29.5	10.0	12.0	4.5	2.360
SO 81221-6-1/4	038.1201.110	125	10x1.0	12	17	31.5	11.0	13.0	4.5	3.000
SO 81221-8-1/4	038.1201.170	80	12x1.0	14	17	33.0	11.0	14.0	6.5	2.430
SO 81221-10-1/4	038.1201.270	60	14x1.0	17	17	35.0	11.0	14.0	8.5	4.180
SO 81221-10-3/8	038.1201.280	60	14x1.0	17	22	36.0	12.0	14.0	8.5	5.900
* SO 81221-10-1/2	038.1201.285	60	16x1.0	19	27	39.0	14.0	14.0	8.5	9.060
SO 81221-12-1/4	038.1201.380	40	16x1.0	19	17	36.0	11.0	14.0	8.5	4.790
SO 81221-12-1/2	038.1201.400	40	16x1.0	19	27	39.0	14.0	14.0	10.0	8.780
SO 81221-15-1/2	038.1201.534	25	20x1.5	24	27	45.0	14.0	18.5	12.5	11.520
SO 81221-15-3/4	038.1201.536	25	20x1.5	24	32	45.5	17.0	16.0	13.0	13.640
SO 81221-18-1/2	038.1201.646	25	24x1.5	27	27	45.0	14.0	17.0	14.5	12.750

2

KONVAV

d=Rohraussen-ø
 e=kleinste Bohrung
 L=Mass in montiertem Zustand
 *=mit reduziertem Klemmring

d=ø extérieur du tube
 e=ø-min. de passage
 L=après montage
 *=avec bague de serrage de reduction

d=tube outside diameter
 e=minimum bore
 L=installed length
 *=with reduction compression ferrule

Verbindungsrippel
Pièce folle
Tube stub

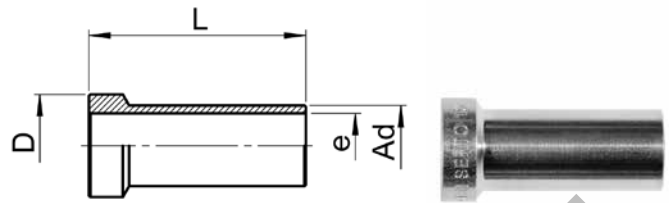

SO 81300

Type -Ad	Mat.-Nr.	bar	L	D	e	kg/100
SO 81300-A6	038.1300.060	125	19.0	8.4	4.0	0.350
SO 81300-A8	038.1300.080	80	22.0	10.5	6.0	0.520
SO 81300-A10	038.1300.100	60	27.0	12.7	8.0	0.850
SO 81300-A12	038.1300.120	40	30.0	14.7	9.0	1.400
SO 81300-A15	038.1300.150	25	31.0	18.0	12.0	2.100
SO 81300-A18	038.1300.180	25	36.0	22.0	15.0	3.200

Anwendungsbeispiele:

Exemples d'utilisation:

Sample combinations:

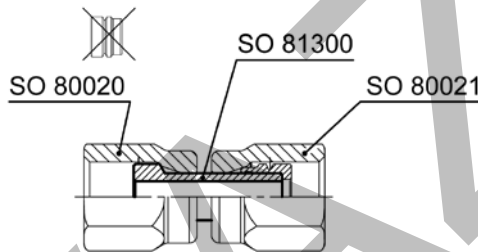

Werden die Verbindungsrippel mit einer Anschlussmutter und einem Armaturenanschluss (Anschlussmutter und Klemmring) verbunden, ergibt dies eine einstellbare Verschraubung.

Si l'insert de la pièce folle est relié à un écrou et à un écrou de raccordement (écrou et bague de serrage), cela fournit une union orientable.

If the tube stubs are coupled with a union nut and a nut connection (union nut and compression ferrule), an adjustable union is produced.

Montagehinweis: Auf Seite des angedrehten Klemmringes (links im Bild) Anschlussmutter mit 1/4 Umdrehung anziehen. Auf Seite des Armaturenanschlusses (rechts im Bild) Anschlussmutter mit 1 3/4 Umdrehung anziehen.

Note d'installation: Serrez l'écrou sur le côté de la bague de serrage tournée (à gauche sur l'illustr.) de 1/4 de tour. Serrez l'écrou de l'autre côté (à droite sur l'illustr.) de 1 3/4 tour.

Assembly information: Tighten the union nut on the side of the turned compression ferrule (left in pict.) with 1/4 turn. Tighten the union nut on the other side (right in pict.) 1 3/4 turns.

Anwendungsbeispiele:

Exemples d'utilisation:

Sample combinations:

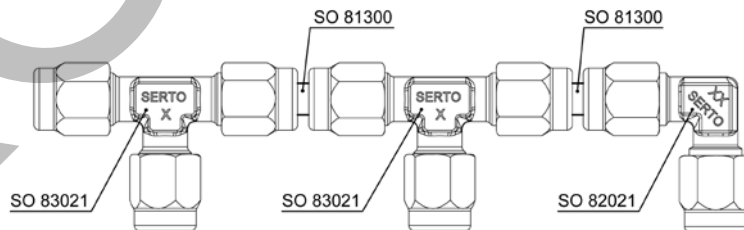

Mit der einstellbaren Verschraubung lassen sich Formteile mit dem gleichen Anschlussgewinde verbinden.

Avec l'union orientable, il est possible de connecter des raccords de même filetages.

With the adjustable union, parts with the same connecting thread can be connected.

Gerade Schottverschraubung

Durchführungslänge max. 5 mm

Union double traversée de cloison

pour cloison max. 5 mm

Panel mount union

max. panel thickness 5 mm

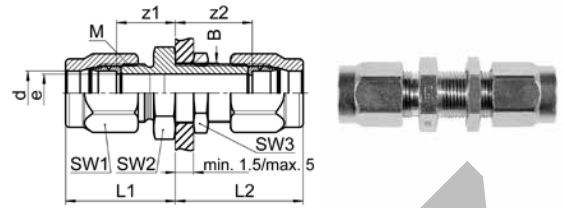

SO 81521

Type -d	Mat.-Nr.	bar	M	SW1	SW2	SW3	L1	L2	B	z1	z2	e	kg/100
SO 81521-6	038.1500.060	125	10x1.0	12	14	14	21.0	26.5	10.5	13.5	19.0	4.5	3.540
SO 81521-8	038.1500.080	80	12x1.0	14	17	17	23.0	28.0	12.5	15.0	20.0	6.5	5.320
SO 81521-10	038.1500.100	60	14x1.0	17	19	19	25.5	31.0	14.5	15.5	21.0	8.5	7.710
SO 81521-12	038.1500.120	40	16x1.0	19	22	19	27.0	32.0	16.5	16.0	21.0	10.0	9.320
SO 81521-15	038.1500.150	25	20x1.5	24	27	27	32.0	37.0	20.5	19.5	24.5	13.0	16.080
SO 81521-18	038.1500.180	25	24x1.5	27	30	27	33.5	36.5	24.5	19.5	22.5	15.0	18.500

Sechskantmutter siehe SO 80006 METR

Ecrou à six pans voir SO 80006 METR

Hexagon nut see SO 80006 METR

d=Rohrassen-ø
e=kleinste Bohrung
L=Mass in montiertem Zustand

d=ø extérieur du tube
e=ø-min. de passage
L=après montage

d=tube outside diameter
e=minimum bore
L=installed length

Einstellnippel
Adaptateur orientable mâle
Adjustable male adaptor

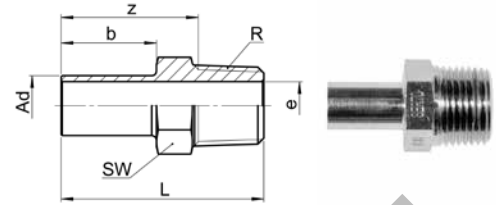

SO 81600

Type -Ad -R	Mat.-Nr.	bar	SW	L	b	z	e	kg/100
R=Rohrgewinde (kegelig)	R=Filetage-gaz BSP (conique)							

Einstellnippel
 radial demontierbar
Adaptateur orientable mâle
 démontable radialement
Adjustable male adaptor
 radial dismantling

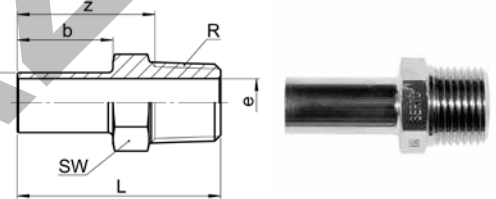

SO 81604

Type -Ad -R	Mat.-Nr.	bar	SW	L	b	z	e	kg/100
R=Rohrgewinde (kegelig)	R=Filetage-gaz BSP (conique)							

Anwendungsbeispiele:

Exemples d'utilisation:

Sample combinations:

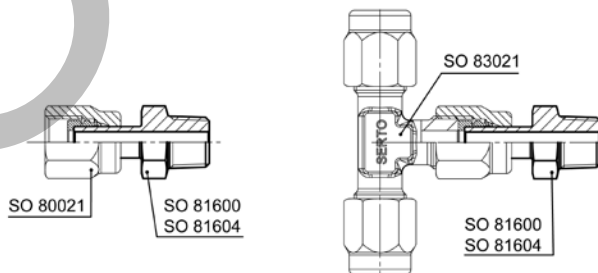

Mögliche Kombinationen:
 - mit Armaturenanschluss zu einstellbaren Anschlüssen
 - mit Verschraubungen zu einstellbaren Verschraubungen

Combinaisons possibles:
 - avec écrou de raccordement ça donne des raccords orientables
 - avec raccords ça donne des raccords orientables

Possible combinations:
 - with nut connection to adjustable connections
 - with unions to adjustable unions

Hinweis: Nur mit Einstellnippel SO 81604 ist eine radiale Demontage möglich.

Remarque: Un démontage radial n'est possible qu'avec l'union orientable mâle SO 81604.

Note: Radial dismantling is only possible with adjustable male adaptor SO 81604.

Reduktionsverschraubung

für Grundteile

Union de réduction

pour corps de raccord

Reduction union

for union body

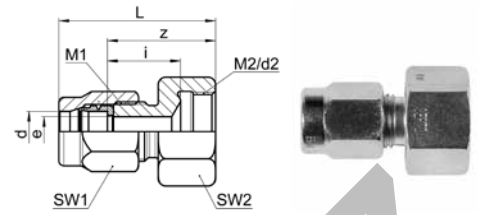

SO 81821

Type -d2-d	Mat.-Nr.	bar	M1	M2	SW1	SW2	L	i	z	e	kg/100
* SO 81821-10-4	038.1800.167	125	10x1.0	14x1.0	12	17	27.5	7.0	13.0	3.4	2.580
SO 81821-10-6	038.1800.175	125	10x1.0	14x1.0	12	17	27.5	7.0	13.0	4.5	2.470
* SO 81821-12-6	038.1800.215	125	12x1.0	16x1.0	14	19	29.5	7.0	14.5	4.5	3.500
SO 81821-12-8	038.1800.225	80	12x1.0	16x1.0	14	19	29.5	7.0	14.5	6.0	3.340
* SO 81821-15-8	038.1800.400	80	14x1.0	20x1.5	17	24	33.5	8.0	15.5	6.5	5.920
SO 81821-15-10	038.1800.410	60	14x1.0	20x1.5	17	24	33.5	8.0	15.5	8.0	5.720
* SO 81821-18-10	038.1800.575	60	16x1.0	24x1.5	19	30	35.5	8.0	16.5	8.5	9.100
SO 81821-18-12	038.1800.580	40	16x1.0	24x1.5	19	30	35.5	8.0	16.5	10.0	8.820

2

Anwendungsbeispiele:

Exemples d'utilisation:

Sample combinations:

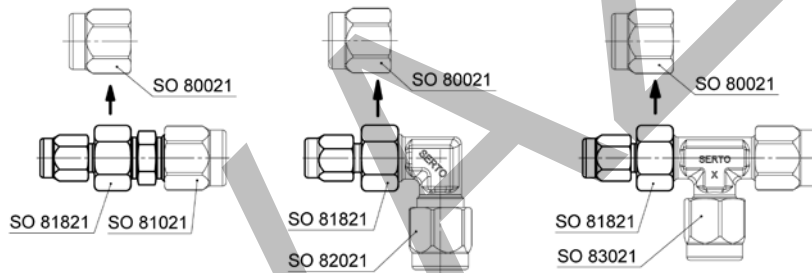

Die Reduktion SO 81821 kann auf jedes SERTO Formteil mit dem passenden Gewinde geschraubt werden und muss mit 1/4 Umdrehung angezogen werden. Durch diese Kombination ergeben sich weitere Rohrreduktionen.

Dichtungsprinzip: Bei der Montage drückt sich die Dichtkante des Übergangstückes in das SERTO Formteil ein. Dadurch entsteht eine einwandfreie metallische Dichtung. Wir empfehlen, das Gewinde mit einem geeigneten Flüssigklebstoff gegen unbeabsichtigtes Lösen zu sichern.

La réduction SO 81821 peut être vissée sur chacune des pièces moulées SERTO avec le filetage correspondant et doit être serré de 1/4 de tour. Cette combinaison permet encore plus des réductions.

Principe d'étanchéité : Lors du montage, l'arête d'étanchéité du réducteur s'appuie sur la pièce moulée SERTO. Cela crée un joint métallique parfait. Nous recommandons de fixer le filetage avec une colle liquide appropriée pour empêcher le desserrage involontaire.

The SO 81821 reduction can be screwed onto all SERTO moulded parts with a matching thread and must be tightened with 1/4 turn. This combination enables further tube reductions.

Sealing principle: On assembly, the sealing edge of the transition piece presses into the SERTO moulded part. This produces a perfect metallic seal. We recommend that the thread is secured against accidental unscrewing by means of a suitable liquid adhesive.

d=Rohrassen-ø
e=kleinste Bohrung
L=Mass in montiertem Zustand
*=mit reduziertem Klemmring

d=ø extérieur du tube
e=ø-min. de passage
L=après montage
*=avec bague de serrage de réduction

d=tube outside diameter
e=minimum bore
L=installed length
*=with reduction compression ferrule

Winkelverschraubung Coude Elbow union

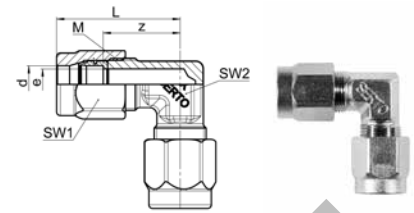

SO 82021

Type -d	Mat.-Nr.	bar	M	SW1	SW2	L	z	e	kg/100
SO 82021-6	038.2000.060	125	10x1.0	12	10	23.5	16.0	4.0	2.750
SO 82021-8	038.2000.080	80	12x1.0	14	10	26.0	18.0	6.0	3.680
SO 82021-10	038.2000.100	60	14x1.0	17	14	30.5	20.5	8.0	6.340
SO 82021-12	038.2000.120	40	16x1.0	19	17	32.5	21.5	10.0	8.700
SO 82021-15	038.2000.150	25	20x1.5	24	19	36.0	23.5	12.0	13.110
SO 82021-18	038.2000.180	25	24x1.5	27	22	40.5	26.5	15.0	18.020

Winkelverschraubung reduziert Coude réduit Elbow reduction union

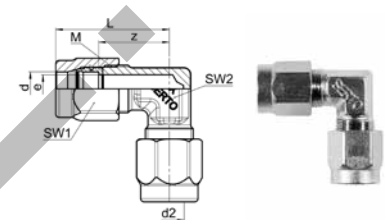

SO 82021 RED

Type -d-d2	Mat.-Nr.	bar	M	SW1	SW2	L	z	e	kg/100
* SO 82021-6-4	038.2004.110	125	10x1.0	12	10	23.5	16.0	3.4	2.860
* SO 82021-8-6	038.2004.140	80	12x1.0	14	10	26.0	18.0	4.5	3.740
* SO 82021-10-8	038.2004.190	60	14x1.0	17	14	30.5	20.5	6.5	6.540
* SO 82021-12-10	038.2004.240	40	16x1.0	19	17	32.5	21.5	8.5	9.000
* SO 82021-15-12	038.2004.420	25	20x1.5	24	19	36.0	23.5	10.0	13.650
* SO 82021-18-15	038.2004.610	25	24x1.5	27	22	40.5	26.5	13.0	18.720

Weitere Reduktionen siehe SO 81821

Autres réductions voir SO 81821

Alternative reductions see SO 81821

d=Rohrassen- \varnothing
 e=kleinste Bohrung
 L=Mass in montiertem Zustand
 *=mit reduziertem Klemmring

d= \varnothing extérieur du tube
 e= \varnothing -min. de passage
 L=après montage
 *=avec bague de serrage de réduction

d=tube outside diameter
 e=minimum bore
 L=installed length
 *=with reduction compression ferrule

Winkelverschraubung

mit Übergangsnippel SO 80040

Coude

avec adaptateur mâle SO 80040

Elbow union

with male adaptor SO 80040

SO 82121

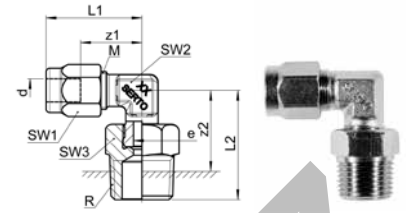

Type -d-R	Mat.-Nr.	bar	M	SW1	SW2	SW3	L1	L2	z1	z2	e	kg/100
R=Rohrgewinde (kegelig)												
				R=Filetage-gaz BSP (conique)								
				R=BSP thread (tapered)								
SO 82121-6-1/4	038.2101.110	125	10x1.0	12	10	14	23.5	30.0	16.0	20.0	4.0	4.400
SO 82121-6-3/8	038.2101.120	125	10x1.0	12	10	17	23.5	29.0	16.0	19.0	4.0	4.930
SO 82121-12-1/2	038.2101.400	40	16x1.0	19	17	22	32.5	39.5	21.5	28.0	10.0	12.290

Montagehinweis: Nippel ist handfest montiert. Bei Endmontage mit 1/4 Umdrehung anziehen.
Wir empfehlen eine zusätzliche Schmierung auf der Planfläche.

Note d'installation: L'adaptateur femelle-mâle est monté serré à la main. Pour le montage final, serrer avec 1/4 de tour.
Nous recommandons une lubrification supplémentaire sur la surface plane.

Assembly information: Male adaptor is mounted finger-tight. For final assembly, tighten with 1/4 turn.
We recommend additional lubrication on the plane surface.

Winkelverschraubung

mit Übergangsmuffe SO 80030

Coude

avec adaptateur femelle SO 80030

Elbow union

with female adaptor SO 80030

SO 82221

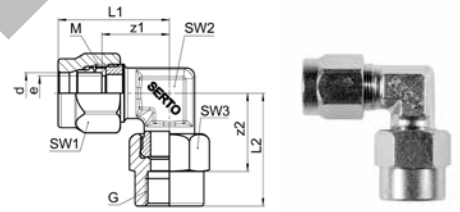

Type -d-G	Mat.-Nr.	bar	M	SW1	SW2	SW3	L1	L2	z1	z2	e	kg/100
G=Rohrgewinde (zylindrisch)												
				G=Filetage-gaz BSP (cylindrique)								
				G=BSP thread (parallel)								
SO 82221-6-1/4	038.2201.110	125	10x1.0	12	10	17	23.5	30.0	16.0	19.0	4.0	4.440
SO 82221-8-1/4	038.2201.170	80	12x1.0	14	10	17	26.0	33.0	18.0	22.0	6.0	5.370
SO 82221-12-3/8	038.2201.390	40	16x1.0	19	17	22	32.5	36.5	21.5	25.5	10.0	9.250

Montagehinweis: Muffe ist handfest montiert. Bei Endmontage mit 1/4 Umdrehung anziehen.
Wir empfehlen eine zusätzliche Schmierung auf der Planfläche.

Note d'installation: L'adaptateur femelle est monté serré à la main. Pour le montage final, serrer avec 1/4 de tour.
Nous recommandons une lubrification supplémentaire sur la surface plane.

Assembly information: Female adaptor is mounted finger-tight. For final assembly, tighten with 1/4 turn.
We recommend additional lubrication on the plane surface.

d=Rohrressen-ø
e=kleinste Bohrung
L=Mass in montiertem Zustand

d=ø extérieur du tube
e=ø-min. de passage
L=après montage

d=tube outside diameter
e=minimum bore
L=installed length

Winkel-Einschraubverschraubung

Coude mâle

Male adaptor elbow union

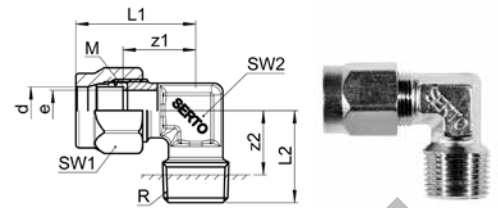

SO 82421

Type -d -R	Mat.-Nr.	bar	M	SW1	SW2	L1	L2	z1	z2	e	kg/100
R=Rohrgewinde (kegelig)	R=Filetage-gaz BSP (conique)										
R=BSP thread (tapered)											
* SO 82421-4-¼	038.2401.065	125	10x1.0	12	10	25.5	22.5	18.0	13.0	3.4	1.800
SO 82421-6-⅝	038.2401.100	125	10x1.0	12	10	23.5	17.5	16.0	12.0	4.5	2.150
SO 82421-6-¼	038.2401.110	125	10x1.0	12	10	25.5	22.5	18.0	13.0	4.0	2.880
SO 82421-8-⅝	038.2401.160	80	12x1.0	14	10	26.0	18.0	18.0	11.5	6.0	2.540
SO 82421-8-¼	038.2401.170	80	12x1.0	14	10	26.0	22.5	18.0	13.0	6.0	3.090
* SO 82421-8-⅜	038.2401.180	80	14x1.0	17	14	30.5	25.0	20.5	15.0	6.5	5.310
SO 82421-10-¼	038.2401.270	60	14x1.0	17	14	30.5	25.0	20.5	15.5	8.0	4.640
SO 82421-10-⅜	038.2401.280	60	14x1.0	17	14	30.5	25.0	20.5	15.0	8.0	5.110
* SO 82421-10-½	038.2401.285	60	16x1.0	19	19	34.0	29.5	23.0	16.5	8.5	9.020
SO 82421-12-¼	038.2401.380	40	16x1.0	19	17	32.5	26.0	21.5	16.5	8.0	8.480
SO 82421-12-⅜	038.2401.390	40	16x1.0	19	17	32.5	26.0	21.5	16.0	10.0	6.120
SO 82421-12-½	038.2401.400	40	16x1.0	19	19	34.0	29.5	23.0	18.0	10.0	8.710
SO 82421-15-½	038.2401.534	25	20x1.5	24	19	36.0	29.5	23.5	18.0	13.0	9.950
SO 82421-18-½	038.2401.646	25	24x1.5	27	22	40.5	31.5	26.5	20.0	15.0	12.520

d=Rohraussen-ø
 e=kleinste Bohrung
 L=Mass in montiertem Zustand
 *=mit reduziertem Klemmring

d=ø extérieur du tube
 e=ø-min. de passage
 L=après montage
 *=avec bague de serrage de réduction

d=tube outside diameter
 L=installed length
 e=minimum bore
 *=with reduction compression ferrule

Einstellbare Winkelverschraubung

Coude orientable

Adjustable elbow union

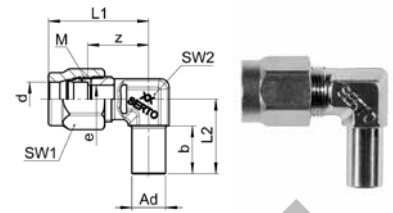

SO 82621

Type -d -Ad	Mat.-Nr.	bar	M	SW1	SW2	L1	L2	b	z	e	kg/100
* SO 82621-4-A6	038.2600.045	125	10x1.0	12	10	23.5	17.5	11.0	16.0	3.4	1.980
SO 82621-6-A6	038.2600.060	125	10x1.0	12	10	23.5	17.5	11.0	16.0	4.0	1.870
* SO 82621-6-A8	038.2600.063	125	12x1.0	14	10	26.0	21.0	13.0	18.0	4.5	2.600
SO 82621-8-A8	038.2600.080	80	12x1.0	14	10	26.0	21.0	13.0	18.0	6.0	2.460
* SO 82621-8-A10	038.2600.083	80	14x1.0	17	14	30.5	26.0	16.5	20.5	8.0	4.180
SO 82621-10-A10	038.2600.100	60	14x1.0	17	14	30.5	26.0	16.5	20.5	8.0	3.990
* SO 82621-10-A12	038.2600.103	60	16x1.0	19	17	33.5	26.5	17.0	21.5	8.5	5.780
SO 82621-12-A12	038.2600.120	40	16x1.0	19	17	33.5	26.5	17.0	21.5	9.0	5.500
SO 82621-15-A15	038.2600.150	25	20x1.5	24	19	36.0	29.0	18.0	23.5	12.0	8.550
* SO 82621-15-A18	038.2600.156	25	24x1.5	27	22	40.5	35.0	20.0	26.5	13.0	13.280
SO 82621-18-A18	038.2600.180	25	24x1.5	27	22	40.5	35.0	20.0	26.5	15.0	12.530

2

Anwendungsbeispiele:

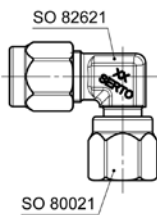

Exemples d'utilisation:

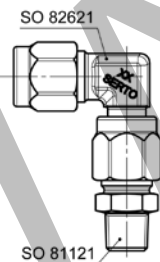

Sample combinations:

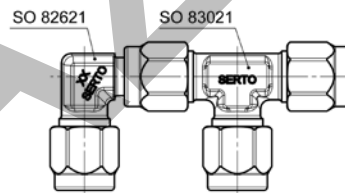

Mögliche Kombinationen:

- mit Armaturenanschluss zu einstellbaren Winkelverschraubungen
- mit Verschraubungen zu einstellbaren Verschraubungen
- mit Einschraubverschraubungen zu einstellbaren Einschraubwinkeln. Gegenüber dem Einschraubwinkel lässt sich diese Kombination einfacher einstellen, da Einschrauben und Ausrichten getrennt voneinander vorgenommen werden.

Combinaisons possibles:

- avec écrou de raccordement ça donne des raccords coudé orientables
- avec raccords ça donne des raccords orientables
- avec une union mâle ça donne un coude fileté orientable. Par rapport au coude orientable, cette combinaison est facile à régler, puisque le vissage et l'alignement sont réalisés séparément l'un de l'autre.

Possible combinations:

- with a nut connection to adjustable elbow unions
- with a union to adjustable unions
- with a male adaptor union to adjustable male adaptor elbow unions. This combination is simpler to produce, as screwing in and alignment are carried out separately.

d=Rohrassen-ø
Ad=Aussen-ø der Andrehung
e=kleinste Bohrung
L=Mass in montiertem Zustand
*=mit reduziertem Klemmring

d=ø extérieur du tube
Ad=ø extérieur de la portée cylindrique
e=ø-min. de passage
L=après montage
*=avec bague de serrage de réduction

d=tube outside diameter
Ad=outside diameter of cyl. stub
e=minimum bore
L=installed length
*=with reduction compression ferrule

Winkel-Schottverschraubung

Durchführungslänge max. 5mm

Coude traversée de cloison

pour cloison max. 5 mm

Panel mount elbow union

max. panel thickness 5 mm

SO 82721

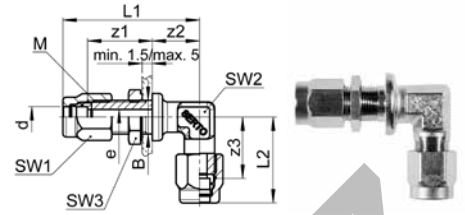

Type -d	Mat.-Nr.	bar	M	SW1	SW2	SW3	L1	L2	B	z1	z2	z3	e	kg/100
* SO 82721-4	038.2700.040	125	10x1.0	12	10	14	40.5	25.5	10.5	19.0	14.0	18.0	3.4	4.270
SO 82721-6	038.2700.060	125	10x1.0	12	10	14	40.5	25.5	10.5	19.0	14.0	18.0	4.0	4.160
SO 82721-8	038.2700.080	80	12x1.0	14	11	17	45.0	28.5	12.5	20.0	17.0	20.5	6.0	6.480
SO 82721-10	038.2700.100	60	14x1.0	17	17	19	49.0	33.5	14.5	21.0	18.0	23.5	8.0	9.560
SO 82721-12	038.2700.120	40	16x1.0	19	17	19	50.0	34.5	16.5	21.0	18.0	23.5	10.0	10.640
SO 82721-15	038.2700.150	25	20x1.5	24	19	27	57.0	38.0	20.5	24.5	20.0	25.5	13.0	18.300

Sechskantmutter siehe SO 80006 METR

Ecrou à six pans voir SO 80006 METR

Hexagon nut see SO 80006 METR

d=Rohrassens-ø
 e=kleinste Bohrung
 L=Mass in montiertem Zustand
 *=mit reduziertem Klemmring

d=ø extérieur du tube
 e=ø-min. de passage
 L=après montage
 *=avec bague de serrage de reduction

d=tube outside diameter
 e=minimum bore
 L=installed length
 *=with reduction compression ferrule

T-Verschraubung
Té égal
Tee union

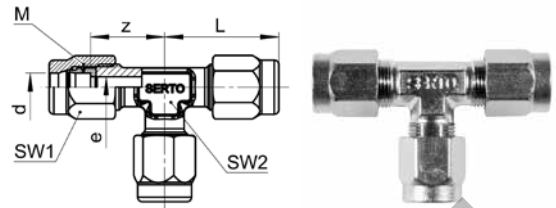

SO 83021

Type -d	Mat.-Nr.	bar	M	SW1	SW2	L	z	e	kg/100
SO 83021-6	038.3000.060	125	10x1.0	12	10	23.5	16.0	4.0	4.240
SO 83021-8	038.3000.080	80	12x1.0	14	10	26.0	18.0	6.0	5.590
SO 83021-10	038.3000.100	60	14x1.0	17	14	30.5	20.5	8.0	8.840
SO 83021-12	038.3000.120	40	16x1.0	19	17	32.5	21.5	10.0	11.320
SO 83021-15	038.3000.150	25	20x1.5	24	19	36.0	23.5	13.0	18.750
SO 83021-18	038.3000.180	25	24x1.5	27	22	40.5	26.5	15.0	25.600

T-Verschraubung
mit Übergangsnippel SO 80040
Té égal
avec adaptateur mâle SO 80040

Tee union
with male adaptor SO 80040

SO 83121

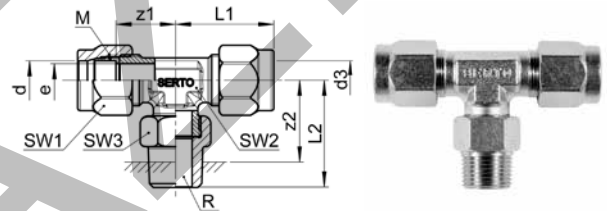

Type -d -R -d3	Mat.-Nr.	bar	M	SW1	SW2	SW3	L1	L2	z1	z2	e	kg/100
R=Rohrgewinde (kegelig)												
			R=Filetage-gaz BSP (conique)									

Montagehinweis: Nippel ist handfest montiert. Bei Endmontage mit 1/4 Umdrehung anziehen.
Wir empfehlen eine zusätzliche Schmierung auf der Planfläche.

Note d'installation: L'adaptateur femelle-mâle est monté serré à la main. Pour le montage final, serrer avec 1/4 de tour.
Nous recommandons une lubrification supplémentaire sur la surface plane.

Assembly information: Male adaptor is mounted finger-tight. For final assembly, tighten with 1/4 turn.
We recommend additional lubrication on the plane surface.

d=Rohrassens-ø
e=kleinste Bohrung
L=Mass in montiertem Zustand

d=ø extérieur du tube
e=ø-min. de passage
L=après montage

d=tube outside diameter
e=minimum bore
L=installed length

T-Verschraubung

mit Übergangsmuffe SO 80030

Té égal

avec adaptateur femelle SO 80030

Tee union

with female adaptor SO 80030

SO 83221

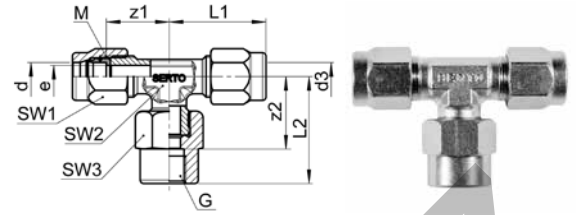

Type -d-G-d3	Mat.-Nr.	bar	M	SW1	SW2	SW3	L1	L2	z1	z2	e	kg/100
G=Rohrgewinde (zylindrisch)	G=Filetage-gaz BSP (cylindrique)	G=BSP thread (parallel)										
SO 83221-6-1/8-6	038.3201.100	125	10x1.0	12	10	14	23.5	29.0	16.0	19.0	4.0	5.090
SO 83221-6-1/4-6	038.3201.110	125	10x1.0	12	10	17	23.5	30.0	16.0	19.0	4.0	5.950
SO 83221-10-1/4-10	038.3201.270	60	14x1.0	17	14	17	30.5	34.5	20.5	23.5	8.0	9.040
SO 83221-10-3/8-10	038.3201.280	60	14x1.0	17	14	22	30.5	36.5	20.5	23.5	8.0	11.710
SO 83221-12-3/8-12	038.3201.390	40	16x1.0	19	17	22	32.5	36.5	21.5	24.5	10.0	13.070
SO 83221-15-3/8-15	038.3201.580	25	20x1.5	24	19	24	36.0	39.0	23.5	27.0	13.0	19.610

Montagehinweis: Muffe ist handfest montiert. Bei Endmontage mit 1/4 Umdrehung anziehen.

Wir empfehlen eine zusätzliche Schmierung auf der Planfläche.

Note d'installation: L'adaptateur femelle est monté serré à la main. Pour le montage final, serrer avec 1/4 de tour.

Nous recommandons une lubrification supplémentaire sur la surface plane.

Assembly information: Female adaptor is mounted finger-tight. For final assembly, tighten with 1/4 turn.

We recommend additional lubrication on the plane surface.

Einstellbare T-Verschraubung

Té orientable au centre

Adjustable tee union

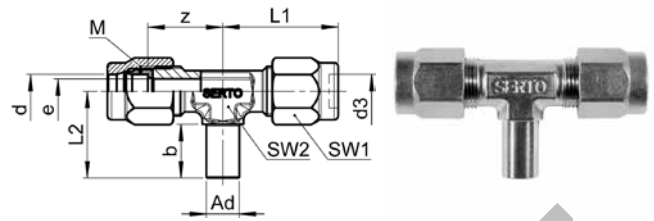

SO 83621 T

Type	d	Ad	d3	Mat.-Nr.	bar	M	SW1	SW2	L1	L2	b	z	e	kg/100
* SO 83621-4-A6-4				038.3600.045	125	10x1.0	12	10	23.5	17.5	11.0	16.0	3.4	3.540
SO 83621-6-A6-6				038.3600.060	125	10x1.0	12	10	23.5	17.5	11.0	16.0	4.0	3.160
SO 83621-8-A8-8				038.3600.080	80	12x1.0	14	10	26.0	21.0	13.0	18.0	6.0	4.230
SO 83621-10-A10-10				038.3600.100	60	14x1.0	17	14	30.5	26.0	16.5	20.5	8.0	6.970

Anwendungsbeispiele:

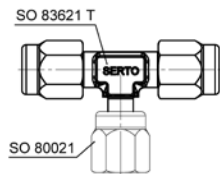

Mögliche Kombinationen:

- mit Armaturenanschluss zu einstellbaren T-Verschraubungen
- mit Verschraubungen zu einstellbaren Verschraubungen
- mit Einschraubverschraubungen zu einstellbaren T-Einschraubverschraubungen. Gegenüber der T-Einschraubverschraubung lässt sich diese Kombination einfacher einstellen, da Einschrauben und Ausrichten getrennt voneinander vorgenommen werden.

Exemples d'utilisation:

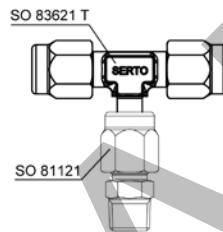

Combinaisons possibles:

- avec écrou de raccordement ça donne un Té orientable
- avec raccords ça donne des raccords orientables
- avec une union mâle ça donne un Té fileté orientable. Par rapport au Té orientable, cette combinaison est facile à régler, puisque le vissage et l'alignement sont réalisés séparément l'un de l'autre.

Sample combinations:

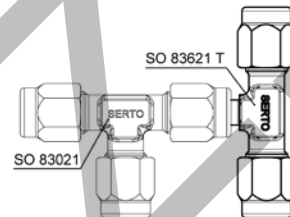

Possible combinations:

- with nut connections to adjustable tee unions
- with unions to adjustable unions
- with male adaptor unions to adjustable male adaptor tee unions. This combination is simpler to produce, as screwing in and alignment are carried out separately.

d=Rohrassens-ø
Ad=Aussen-ø der Andrehung
e=kleinste Bohrung
L=Mass in montiertem Zustand
*=mit reduziertem Klemmring

d=ø extérieur du tube
Ad=ø extérieur de la portée cylindrique
e=ø-min. de passage
L=après montage
*=avec bague de serrage de réduction

d=tube outside diameter
Ad=outside diameter of cyl. stub
e=minimum bore
L=installed length
*=with reduction compression ferrule

Einstellbare L-Verschraubung

Té orientable en bout

Adjustable L union

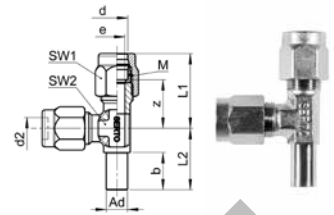

SO 83621 L

Type	d	d2	Ad	Mat.-Nr.	bar	M	SW1	SW2	L1	L2	b	z	e	kg/100
* SO 83621-4-4-A6				038.3610.045	125	10x1.0	12	10	23.5	17.5	11.0	16.0	3.4	3.600
SO 83621-6-6-A6				038.3610.060	125	10x1.0	12	10	23.5	17.5	11.0	16.0	4.0	3.220
SO 83621-8-8-A8				038.3610.080	80	12x1.0	14	10	26.0	21.0	13.0	18.0	6.0	4.260
SO 83621-10-10-A10				038.3610.100	60	14x1.0	17	14	30.5	26.0	16.5	20.5	8.0	7.000

Anwendungsbeispiele:

Exemples d'utilisation:

Sample combinations:

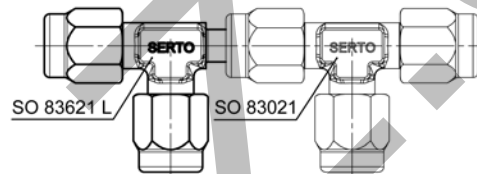
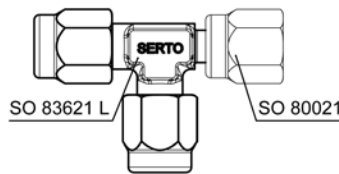

Mögliche Kombinationen:

- mit Armaturenanschluss zu einstellbaren L-Verschraubungen
- mit Verschraubungen zu einstellbaren Verschraubungen
- mit Einschraubverschraubungen zu einstellbaren L-Einschraubverschraubungen. Gegenüber der L-Einschraubverschraubung lässt sich diese Kombination einfacher einstellen, da Einschrauben und Ausrichten getrennt voneinander vorgenommen werden.

Combinaisons possibles:

- avec écrou de raccordement ça donne un L orientable
- avec raccords ça donne des raccords orientables
- avec une union mâle ça donne un L fileté orientable. Par rapport au L orientable, cette combinaison est facile à régler, puisque le vissage et l'alignement sont réalisés séparément l'un de l'autre.

Possible combinations:

- with nut connections to adjustable L unions
- with unions to adjustable unions
- with male adaptor unions to adjustable male adaptor L unions. This combination is simpler to produce, as screwing in and alignment are carried out separately.

d=Rohrassen-ø
Ad=Aussen-ø der Andrehung
e=kleinste Bohrung
L=Mass in montiertem Zustand
*=mit reduziertem Klemmring

d=ø extérieur du tube
Ad=ø extérieur de la portée cylindrique
e=ø-min. de passage
L=après montage
*=avec bague de serrage de réduction

d=tube outside diameter
Ad=outside diameter of cyl. stub
e=minimum bore
L=installed length
*=with reduction compression ferrule

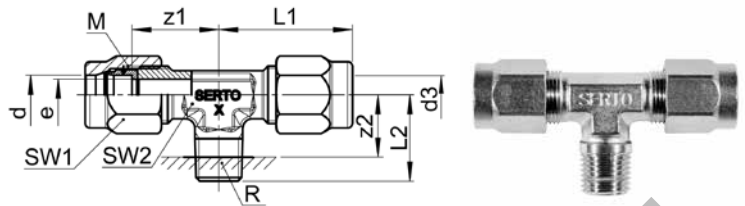
T-Einschraubverschraubung
Té mâle au centre
Male adaptor Tee union

SO 83721 T

Type -d -R -d3	Mat.-Nr.	bar	M	SW1	SW2	L1	L2	z1	z2	e	kg/100
R=Rohrgewinde (kegelig)	R=Filetage-gaz BSP (conique)	R=BSP thread (tapered)									
SO 83721-4-1/8-4	038.3701.040	125	8x1.0	10	10	22.0	17.0	16.0	10.5	3.4	2.350
* SO 83721-4-1/4-4	038.3701.045	125	10x1.0	12	10	25.5	21.5	18.0	13.0	3.4	4.110
SO 83721-5-1/8-5	038.3701.070	125	8x1.0	10	10	22.5	17.0	16.0	10.5	4.0	2.330
* SO 83721-5-1/4-5	038.3701.075	125	10x1.0	12	10	25.5	21.5	18.0	13.0	4.0	4.060
SO 83721-6-1/8-6	038.3701.100	125	10x1.0	12	10	23.5	17.5	16.0	11.0	4.0	3.240
SO 83721-6-1/4-6	038.3701.110	125	10x1.0	12	10	25.5	21.5	18.0	13.0	4.0	4.000
SO 83721-8-1/4-8	038.3701.170	80	12x1.0	14	10	26.0	22.5	18.0	13.0	6.0	4.730
SO 83721-10-1/4-10	038.3701.270	60	14x1.0	17	14	30.5	25.0	20.5	15.5	8.0	7.900

2

KONVARI

d=Rohraussen-ø
 e=kleinste Bohrung
 L=Mass in montiertem Zustand
 *=mit reduziertem Klemmring

d=ø extérieur du tube
 e=ø-min. de passage
 L=après montage
 *=avec bague de serrage de réduction

d=tube outside diameter
 e=minimum bore
 L=installed length
 *=with reduction compression ferrule

Adapter Messing CV

Adaptateurs laiton CV

Adaptors brass CV

AD FA 80



Übergangsmuffe G-G
Adaptateur femelle G - femelle G
Female adaptor G-G

676

AD A 80 G-R



Übergangsnippel G-R
Adaptateur femelle G - mâle R
Adaptor female G - male R

676

AD A 80 NPT-R



Übergangsnippel NPT-R
Adaptateur femelle NPT - mâle R
Adaptor female NPT - male R

667

AD SP 80



Verschlusschraube R mit Innen-Ókt.
Bouchon fileté R avec six pans creux
Screw plug R locked with Allen key

677

SO 80511



Einschraubtülle R
Douille cannelée à visser R
Male adaptor hose nozzle R

677

Messing G

Verschraubungen

























Laiton G

Raccords

Brass G

Unions



	Seite/Page/Page		Seite/Page/Page		Seite/Page/Page
Klemmring Bague de serrage Compression ferrule	159-161 	Übergangsnippel Adaptateur femelle - mâle Male adaptor	172-173 	Winkelverschraubung Coude Elbow union	189-192 
	SO 00001		SO 00040		SO 02021
Abschlusszapfen Bouchon d'arrêt Plug	162 	Anschlussnippel Ecrou de raccordement mâle Nipple connection	174 	Anschlusswinkel Coude femelle Female adaptor elbow union	193 
	SO 40002		SO 01001		SO 02321
Stützhülse Douille d'appui Stiffener sleeve	163 	Gerade Verschraubung Union double Straight union	175-177 	Winkel-Einschraubverschraubung Coude mâle Male adaptor elbow union	194-195 
	SO 40003		SO 01011		SO 02421
Dichtung Joint Washer	164-166 	Gerade Einschraubverschraubung Union mâle Male adaptor union	178-181 	Winkel-Aufschraubverschraubung Coude femelle Female adaptor elbow union	196 
	SO 40005		SO 01121		SO 02521
Sechskantmutter Ecrou à six pans Hexagon nut	165 	Gerade Aufschraubverschraubung Union femelle Female adaptor union	182 	Einstellbare Winkelverschraubung Coude orientable Adjustable elbow union	197 
	SO 40006		SO 01221		SO 02621
Anschlussmutter Ecrou Union nut	167 	Verschraubung mit Einlötnippel Union avec embout à braser Adaptor union with soldering nipple	183 	Winkel-Schottverschraubung Coude traversée de cloison Panel mount elbow union	198 
	SO 00020		SO 01421		SO 02721
Armaturenanschluss Ecrou et bague de raccordement Nut connection	168-169 	Gerade Schottverschraubung Union double pour passage de cloison Panel mount union	184-186 	T-Verschraubung Té égal Tee union	199-203 
	SO 00021		SO 01521		SO 03021
Übergangsmuffe Adaptateur femelle Female adaptor	170-171 	Einstellnippel Adaptateur orientable mâle Adjustable male adaptor	187-188 	Einstellbare T-Verschraubung Té orientable au centre Adjustable tee union	204 
	SO 00030		SO 41600		SO 03621 T

Seite/Page/Page

Einstellbare L-Verschraubung
Té orientable en bout
Adjustable L union



205
SO 03621 L

Sonderausführungen auf Anfrage
Exécution en option sur demande
Optional services on request

Spezialreinigung - entfettet
Traitement spécial - dégraissé
Special treatment - degreased

Spezialbehandlung für Einsatz mit Sauerstoff
Traitement spécial pour utilisation sous oxygène
Special treatment for use with oxygen

Spezialbehandlung - silikonfrei
Traitement spécial - sans silicone
Special treatment - silicone free

Vorbeschichtete Gewinde mit Loctite 5061
Filetages pré enduits avec Loctite 5061
Pre-coated threads with Loctite 5061

Vorbeschichtete Gewinde PTFE-Band umwickelt
Filetages pré enduits avec ruban en PTFE
Pre-coated threads with PTFE-tape

Chemisch vernickelt
Nickelage chimique
Chemical nickel-plated

Messing bleiarml
Laiton à faible teneur en plomb
Low-lead brass

T-Einschraubverschraubung
Té mâle au centre
Male adaptor Tee union



206
SO 03721 T

L-Einschraubverschraubung
Té mâle en bout
Male adaptor L union



207
SO 03721 L

Kreuzverschraubung
Croix égale
Cross union



208
SO 04021

T-Winkverschraubung
Té distributeur en V
3-way side outlet elbow



209
SO 05021



Messing G

Laiton G

Brass G

Eigenschaften, Besonderheiten

- einfache, schnelle Montage
- kompakte Baumasse
- grosse Sortimentsvielfalt
- sehr viele Kombinationsmöglichkeiten
- zwei Ausführungen:
M = Anschlussmutter metrisch
G = Anschlussmutter Rohrgewinde (Zoll)
(M und G nicht austauschbar)

Funktionsprinzip

Siehe Kapitel i

Werkstoff

Messing CW617N (CuZn40Pb2), Oberfläche gebeizt

Betriebsdruck PN

Siehe Produkttabellen (4-fache Sicherheit)

Temperaturbereich

-196°C bis +180°C

Helium-Leckrate

10^{-8} mbar • l/s *

Vakuum

Bis 10^{-4} mbar, höhere Werte möglich

Anzuschliessende Rohre

Kunststoffrohre und nahtlose, gezogene Kupferrohre (insbes. EN 12449/1057) mit sauberer, glatter Oberfläche, Toleranz Aussendurchmesser ± 0.1 mm, Rohre $\varnothing < 6$ mm Toleranz ± 0.05 mm; Ausnahme: Kunststoffrohre. Siehe auch Kapitel i und Kapitel 19. Weitere Materialien auf Anfrage.

Zulassungen

SVGW, DVGW

Einschraubzapfen, Gewinde

Rohrgewinde (Zoll) und metrisches Feingewinde DIN 3852, kegelig nach Form C, mit Dichtkante nach Form B. NPT-Gewinde nach ANSI B1.20.1.
Zum Abdichten der kegelligen Einschraubgewinde empfehlen wir das PTFE Band AC 840/841 oder Loctite 5061.

Druckauswertungsgrad in % des PN



Propriétés, spécificités

- montage facile et rapide
- compactes dimensions
- vaste gamme de produits
- multiples possibilités de combinaisons
- deux exécutions:
M = écrou SERTO avec filetage métrique
G = écrou SERTO avec filetage gaz (BSP)
(M et G ne sont pas interchangeables)

Principe de fonctionnement

Voir chapitre i

Matériau

Laiton CW617N (CuZn40Pb2), la surface est décapée

Pression de service PN

Voir tableaux des produits (facteur de sécurité 4)

Plage de température admissible

-196°C à +180°C

Débit de fuite avec hélium

10^{-8} mbar • l/s *

Vide

Jusqu'à 10^{-4} mbar, valeurs plus élevées possible

Tubes à utiliser

Tubes en matière plastique et tous les tubes en cuivre sans soudure (selon EN 12449/1057) avec surface propre et lisse. Tolérance du diamètre extérieur de ± 0.1 mm, tubes $\varnothing < 6$ mm tolérance ± 0.05 mm; exception: tubes en plastique. Voir aussi chapitre i et chapitre 19. Autres matériaux sur demande.

Certifications

SSIGE, DVGW

Embouts mâles, filetages

Filetage-gaz (BSP) et filetage métrique à pas fin DIN 3852; conique selon forme C; filetage d'étanchéité selon forme B. Filetage NPT selon ANSI B1.20.1.
Pour assurer l'étanchéité des filetages mâles coniques, nous recommandons le ruban en PTFE AC 840/841 ou Loctite 5061.

Coefficient de pression de service admissible en % de PN

Characteristics, specialities

- easy and fast to install
- compact size
- extensive product range
- many combination possibilities
- two models:
M = connection nut with metric thread
G = connection nut with British Standard Pipe (BSP) thread
(M and G are not interchangeable)

Operating principle

See chapter i

Material

Brass CW617N (CuZn40Pb2), the surface is pickled

Working pressure PN

See product tables (safety factor 4)

Temperature range

-196°C to +180°C

Leak rate with helium

10^{-8} mbar • l/s *

Vacuum

Up to 10^{-4} mbar, higher values are possible

Tubes to use

Tubes of plastic and seamless copper tubes (esp. EN 12449/1057) with clean smooth surface. Tolerance of outside diameter ± 0.1 mm, tubes $\varnothing < 6$ mm tolerance ± 0.05 mm; exception: plastic tubes. See also chapter i and chapter 19. Further materials on request.

Approvals

SVGW, DVGW

Adaptor stem, male thread

British Standard Pipe (BSP) and metric fine thread DIN 3852; tapered form C; thread with edge seal form B. NPT-thread according to ANSI B1.20.1.
For sealing of the tapered male adaptor thread we recommend the PTFE tape AC 840/841 or Loctite 5061.

Pressure coefficient % of PN

* bei fachgerechter Montage; siehe Kapitel i:
- Montageanleitung
- Rohrempfehlungen

* à la base d'un montage dans les règles de l'art; voir chapitre i:
- Instructions de montage
- Recommandations pour tubes

* when professionally assembled; see chapter i:
- Installation instructions
- Recommendations for tubes

Klemmring

Bague de serrage

Compression ferrule

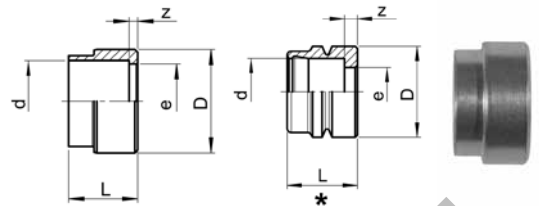
SO 00001

Type -d	Mat.-Nr.	bar	L	D	z	e	kg/100	
Für metrische Rohre	Pour tubes métriques		For metric tubes					
SO 40001-4	016.0010.040	125	5.0	6.0	1.0	3.4	0.050	
SO 40001-5	016.0010.050	125	5.5	6.8	1.0	4.0	0.060	
SO 40001-6 *	016.0010.060	250	6.5	8.4	1.2	4.5	0.120	
SO 00001-8	246.0010.080	125	7.0	11.0	1.0	7.0	0.190	
SO 00001-10	246.0010.100	100	8.0	13.5	1.0	9.0	0.320	
SO 00001-12	246.0010.120	100	10.0	16.0	1.2	11.0	0.530	
SO 00001-14	246.0010.140	64	12.0	18.0	1.5	13.0	0.760	
SO 00001-15	246.0010.150	64	12.0	18.5	1.5	14.0	0.740	
Für Zollrohre	Pour tubes pouces		For inch tubes					
SO 40001-6,35 *	016.0010.063	250	6.5	8.4	1.2	4.5	0.110	
SO 00001-7,94	246.0010.079	125	7.0	11.0	1.0	7.0	0.190	
SO 00001-9,52	246.0010.095	100	8.0	13.0	1.0	8.0	0.310	
SO 00001-12,7	246.0010.127	100	10.0	17.0	1.2	11.0	0.600	

Umrechnung für "d" bei Zollrohren:

6,35 = 1/4
 7,94 = 5/16
 9,52 = 3/8
 12,7 = 1/2

Conversion de "d" pour tubes en pouces:

6,35 = 1/4
 7,94 = 5/16
 9,52 = 3/8
 12,7 = 1/2

Conversion for "d" for inch tubes:

6,35 = 1/4
 7,94 = 5/16
 9,52 = 3/8
 12,7 = 1/2

Klemmring

für Thermofühler

Bague de serrage

pour sondes

Compression ferrule

for temperature probes

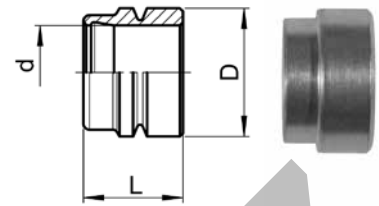

SO 00001 D

Type -d	Mat.-Nr.	bar	L	D	kg/100
SO 40001-4 D	016.0012.040	125	5.0	6.0	0.050
SO 40001-6 D	016.0012.060	100	6.5	8.5	0.110
SO 40001-6-4 D	016.0012.110	100	8.5	8.4	0.210
SO 00001-8 D	246.0012.080	100	7.0	11.0	0.180
SO 00001-10 D	246.0012.100	64	8.0	13.5	0.300
SO 00001-12 D	246.0012.120	64	10.0	16.0	0.530
SO 00001-14 D	246.0012.140	40	12.0	18.0	0.720
SO 00001-15 D	246.0012.150	40	12.0	18.5	0.750

Anwendungsbeispiele:

Messleitungen können durch den Klemmring ohne Innenbund durchgesteckt werden. Durchgangsverschraubungen für Messleitungen sind auch erhältlich. Bei Bestellung ist die Typennummer der Standard Verschraubung zusätzlich mit "D" zu ergänzen. z.B. SO 01121-8-1/4 D.

Exemples d'utilisation:

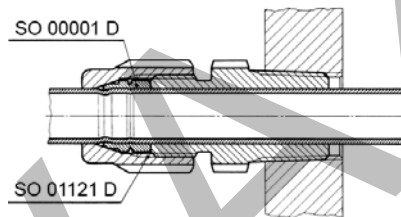

Les lignes de mesure peuvent être insérées à travers la bague de serrage sans collet intérieur. Des raccords pour conduites de mesure sont également disponibles. Lors de la commande, le numéro de type du raccord standard doit être complété avec la lettre "D", par exemple SO 01121-8-1/4 D.

Sample combinations:

Measuring lines can be pushed through the compression ferrule without collar. Unions for gauge lines are also available. For ordering, the type number of the standard union must be supplemented with "D", e.g. SO 01121-8-1/4 D.

Klemmring

für Manometeranschluss

Bague de serrage

pour écrou de manomètre

Compression ferrule

for pressure gauge connection

SO 0001 MAN

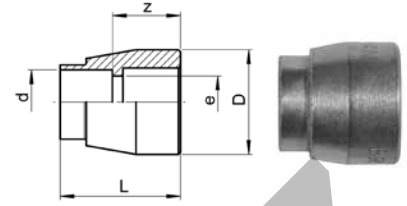

Type -d -G	Mat.-Nr.	bar	L	D	z	e	kg/100
G=Rohrgewinde (zylindrisch)	G=Filetage-gaz BSP (cylindrique)	G=BSP thread (parallel)					
SO 0001-6-¼ MAN	246.0011.110	125	8.5	9.0	3.5	5.5	0.190
SO 0001-6-½ MAN	246.0011.125	125	11.5	10.0	6.5	5.0	0.330
SO 0001-8-½ MAN	246.0011.185	125	11.5	12.0	5.5	6.5	0.520

Diese Klemmringe SO 0001 MAN dürfen nur mit der Anschlussmutter für Manometer verwendet werden, deren Bestellnummer "MAN" enthält. Für alle anderen Manometeranschlüsse wird der Klemmring SO 0001 verwendet.
G = Gewindeanschluss am Manometer

Les bagues de serrage SO 0001 MAN doivent être utilisées uniquement avec les écrous portant la désignation «MAN». Pour d'autres dimensions, utiliser la bague de serrage SO 0001.
G = filetage de raccordement au manomètre

These compression ferrules SO 0001 MAN must only be used with the union nut for pressure gauges of which the order number contains "MAN". For all other pressure gauge connections the compression ferrule SO 0001 is to be used.
G = thread connection on pressure gauge

Abschlusszapfen Bouchon d'arrêt Plug

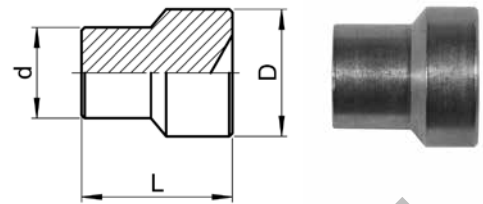

SO 40002

Type -d	Mat.-Nr.	L	D	kg/100
Für metrische Rohre	Pour tubes métriques		For metric tubes	
SO 40002-4	016.0020.040	8.0	6.8	0.150
SO 40002-5	016.0020.050	8.5	6.8	0.190
SO 40002-6	016.0020.060	10.0	8.4	0.320
SO 40002-8	016.0020.080	10.5	10.5	0.570
SO 40002-10	016.0020.100	13.0	12.7	0.970
SO 40002-12	016.0020.120	14.0	14.8	1.550
SO 40002-14/15	016.0020.140	15.0	17.5	2.220

Für Zollrohre	Pour tubes pouces		For inch tubes	
SO 40002-6,35	016.0020.063	10.0	8.4	0.330
SO 40002-7,94	016.0020.079	10.5	10.5	0.560
SO 40002-9,52	016.0020.095	13.0	12.7	0.960
SO 40002-12,7	016.0020.127	14.0	14.8	1.550

Umrechnung für "d" bei Zollrohren:

6,35 = 1/4
7,94 = 5/16
9,52 = 3/8
12,7 = 1/2

Conversion de "d" pour tubes en pouces:

6,35 = 1/4
7,94 = 5/16
9,52 = 3/8
12,7 = 1/2

Conversion for "d" for inch tubes:

6,35 = 1/4
7,94 = 5/16
9,52 = 3/8
12,7 = 1/2

Anwendungsbeispiele:

Exemples d'utilisation:

Sample combinations:

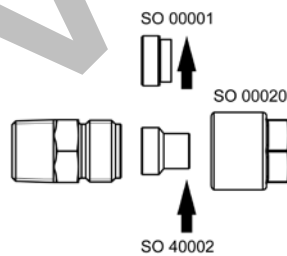

Der Abschlusszapfen lässt sich in jede Verschraubung anstelle eines Klemmringes der gleichen Grösse einsetzen.

Montagehinweis: Anschlussmutter mit 1/4 Umdrehung anziehen.

Le bouchon d'arrêt s'insère dans tout raccord au lieu d'une bague de serrage de la même taille.

Note d'installation: Serrez l'écrou d'accouplement de 1/4 de tour.

The plug can be inserted into all unions instead of a compression ferrule of the same size.

Assembly information: Tighten the union nut with 1/4 turn.

Stützhülse

zur Rohrverstärkung

Douille d'appui

pour renforcer les tubes

Stiffener sleeve

to reinforce tubes

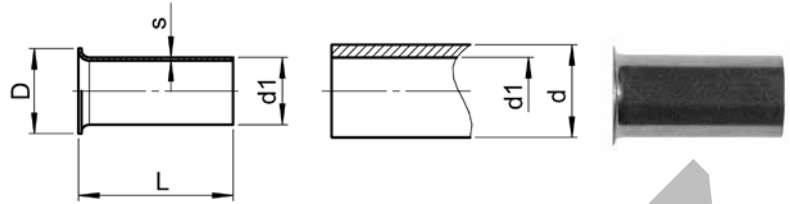

SO 40003

Type - d - d1	Mat.-Nr.	L	D	s	kg/100
Für metrische Rohre	Pour tubes métriques			For metric tubes	
SO 40003-4-2	016.0030.030	8.0	3.8	0.20	0.008
SO 40003-4-2,5	016.0030.035	8.0	3.8	0.20	0.010
SO 40003-4-3	016.0030.040	8.0	3.8	0.20	0.010
SO 40003-5-3	016.0030.060	8.0	4.5	0.20	0.015
SO 40003-5-3,5	016.0030.075	8.0	4.5	0.20	0.020
SO 40003-6-3	016.0030.100	10.0	5.2	0.20	0.015
SO 40003-6-4	016.0030.110	10.0	5.5	0.20	0.025
SO 40003-6-4,4	016.0030.113	10.0	5.5	0.20	0.025
SO 40003-6-4,65	016.0030.116	10.0	5.5	0.20	0.025
SO 40003-6-4,7 D	016.0030.118	10.0	5.5	0.40	0.046
SO 40003-8-5	016.0030.136	12.0	7.5	0.25	0.040
SO 40003-8-5,5	016.0030.138	12.0	7.5	0.25	0.045
SO 40003-8-6	016.0030.140	12.0	7.5	0.25	0.045
SO 40003-8-6,4	016.0030.144	12.0	7.5	0.25	0.050
SO 40003-10-7	016.0030.180	16.0	9.5	0.30	0.080
SO 40003-10-7,5	016.0030.185	16.0	9.5	0.30	0.090
SO 40003-10-8 D	016.0030.189	16.0	9.5	0.60	0.190
SO 40003-10-8	016.0030.190	16.0	9.5	0.30	0.100
SO 40003-10-8,4	016.0030.192	16.0	9.5	0.30	0.095
SO 40003-10-8,6	016.0030.193	16.0	9.5	0.30	0.095
SO 40003-12-9	016.0030.230	20.0	11.5	0.40	0.190
SO 40003-12-9,5	016.0030.235	20.0	11.5	0.40	0.195
SO 40003-12-10	016.0030.240	20.0	11.5	0.40	0.195
SO 40003-12-10,4	016.0030.254	20.0	11.5	0.40	0.195
SO 40003-12-11 D	016.0030.257	20.0	12.0	1.00	0.500
SO 40003-13-11 D	016.0030.279	20.0	12.5	1.00	0.530
SO 40003-13-11	016.0030.280	20.0	12.5	0.50	0.330
SO 40003-14-11	016.0030.330	20.0	12.5	0.50	0.330
SO 40003-14-11,5	016.0030.335	24.0	13.5	0.50	0.350
SO 40003-14-12	016.0030.340	24.0	13.5	0.50	0.370
SO 40003-15-12,5	016.0030.425	24.0	14.5	0.50	0.390
SO 40003-15-13	016.0030.430	24.0	14.5	0.50	0.390

Werkstoff: Messing CW508L

Verstärken:

Dünnwandige und weiche Rohre sowie alle Kunststoffrohre sind mit Stützhülsen zu verstärken.

Genauere Angaben über das Verstärken siehe Kapitel i.

Hilfswerkzeuge zum Entgraten und Kalibrieren der Rohre siehe Kapitel 21.

Typenbezeichnung mit D: für weiches oder sehr dünnwandiges Kupferrohr.

Matériau: Laiton CW508L

Renforcement:

Tubes à paroi mince et tubes souples ainsi que tubes en plastique doivent être renforcés à l'aide de douilles d'appui.

Pour des indications concernant le renforcement voir chapitre i.

Pour des outils pour l'ébarbage et le calibrage du tube voir chapitre 21.

Types avec D: pour des tubes de cuivre mous ou à parois très minces.

Material: Brass CW508L

Reinforcement:

Thin walled, soft tubes and all plastic tubes are to be reinforced with stiffener sleeves.

Details concerning stiffening are to be found in chapter i.

For useful tools for deburring and calibrating tubes see chapter 21.

Types with D: for soft or very thin-walled copper tubes.

d=Rohraussen- \varnothing
d1=Rohrinnen- \varnothing
s=Rohrwandstärke

d= \varnothing extérieur du tube
d1= \varnothing intérieur de tube
s=épaisseur de la paroi du tube

d=tube outside diameter
d1=tube inside diameter
s=tube wall thickness

Dichtung für Innengewinde

Joint pour taraudage

Washer for female threads

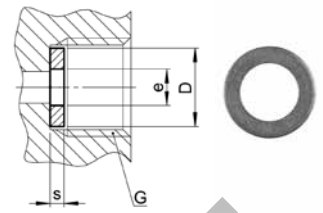

SO 40005

Type -d-G	Mat.-Nr.	D	s	e	kg/100
G=Rohrgewinde (zylindrisch)		G=Filetage-gaz BSP (cylindrique)		G=BSP thread (parallel)	
SO 40005-4-1/8	016.0050.060	8.5	2.00	4.0	0.070
SO 40005-5-1/8	016.0050.082	8.5	2.00	4.0	0.070
SO 40005-6-1/4	016.0050.110	11.2	2.00	5.2	0.130
SO 40005-8-1/4	016.0050.170	11.2	2.00	6.8	0.090
SO 40005-8,2-1/4	016.0050.173	11.2	2.00	8.2	0.080
SO 40005-10-3/8	016.0050.280	14.8	2.00	9.0	0.170
SO 40005-10,2-3/8	016.0050.283	14.8	2.00	10.2	0.150
SO 40005-12-1/2	016.0050.400	18.5	2.00	10.0	0.330
SO 40005-14-1/2	016.0050.504	18.5	2.00	13.5	0.210
SO 40005-15-1/2	016.0050.534	18.5	2.00	13.5	0.210
SO 40005-15-3/4	016.0050.536	24.0	2.00	14.2	0.490
SO 40005-17-3/4	016.0050.598	24.0	2.00	16.2	0.410
SO 40005-18-7/8	016.0050.650	27.8	2.00	16.2	0.700
SO 40005-22-1	016.0050.770	30.0	2.00	20.0	0.670

Anwendungsbeispiele:

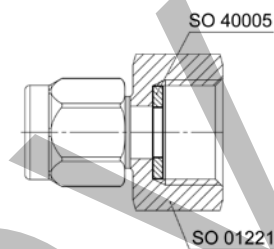

Material: Kupfer weich

Zu verwenden:
 Als stirnseitige Abdichtung in Anschlussgewinden bei Verschraubungen z.B. SO 01221 und bei Übergangsmuffe SO 00030 (nicht abgebildet).
 Als Auflage für den Klemmring bei Verwendung von Einschraubstutzen SO 01001.

Exemples d'utilisation:

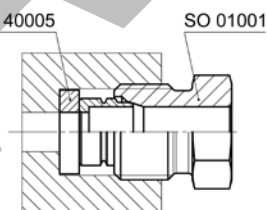

Matériau: cuivre mou

Pour l'utilisation:
 Comme l'étanchéité de la façade dans les filets au niveau des raccords à vis par exemple SO 01221 et au niveau de l'adaptateur femelle SO 00030 (non illustré).
 Comme support de la bague de serrage pour l'utilisation d'écrou de raccord mâle SO 01001.

Sample combinations:

Material: soft copper

Use:
 As a face side seal in connecting threads for screw fittings, e.g. SO 01221 and for female adaptor SO 00030 (not illustrated).
 As a support for the compression ferrule if the nipple connection SO 01001 is used.

Sechskantmutter
Ecrou à six pans
Hexagon nut

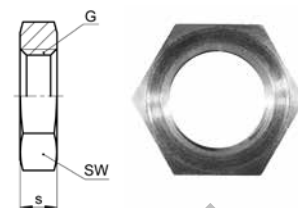

SO 40006

Type -G	Mat.-Nr.	SW	s	kg/100
G=Rohrgewinde (zylindrisch)	G=Filetage-gaz BSP (cylindrique)	G=BSP thread (parallel)		
SO 40006-1/8	016.0061.020	14	5.00	0.410
SO 40006-1/4	016.0061.040	19	6.00	0.910
SO 40006-3/8	016.0061.060	24	6.00	1.430
SO 40006-1/2	016.0061.080	30	7.00	2.580

Sechskantmutter für SO 01521, SO 01524, SO 02721

Ecrou à six pans pour SO 01521, SO 01524, SO 02721

Hexagon nut for SO 01521, SO 01524, SO 02721

Dichtung für Aussengewinde METR
Joint pour filetage METR
Washer for male thread METR

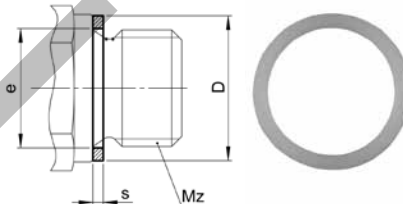

SO 40507 METR

Type -Mz	Mat.-Nr.	D	s	e	kg/100
Mz=metrisches Gewinde (zylindrisch)	Mz=Filetage métrique (cylindrique)	Mz=Metric thread (parallel)			
SO 40507-M5	016.0075.080	8.0	1.00	5.2	0.005
SO 40507-M5-2	016.0075.083	8.0	2.00	5.2	0.010
SO 40507-M6	016.0075.100	9.0	1.00	6.2	0.004
SO 40507-M8/G1/16"	016.0075.120	10.0	1.00	8.2	0.003
SO 40507-M10/G1/8"	016.0075.150	12.0	1.00	10.2	0.006

Material: Kunststoff POM

Matériau: Plastique POM

Material: Plastic POM

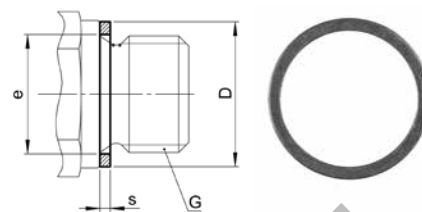
Dichtung für Aussengewinde
Joint pour filetage
Washer for male thread

SO 40007

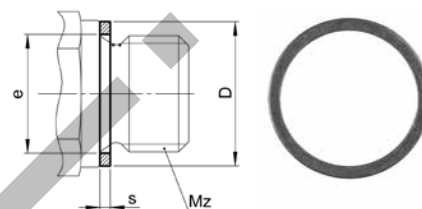
Type -G	Mat.-Nr.	D	s	e	kg/100
G=Rohrgewinde (zylindrisch)	G=Filetage-gaz BSP (cylindrique)	G=BSP thread (parallel)			
SO 40007-1/8	016.0070.020	13.4	1.50	10.2	0.050
SO 40007-1/4	016.0070.040	17.9	1.50	14.2	0.110
SO 40007-3/8	016.0070.060	21.0	1.50	17.2	0.130
SO 40007-1/2	016.0070.080	25.9	1.50	21.2	0.220
SO 40007-3/4	016.0070.120	31.0	1.50	26.5	0.230

Dichtung für Aussengewinde METR
Joint pour filetage METR
Washer for male thread METR

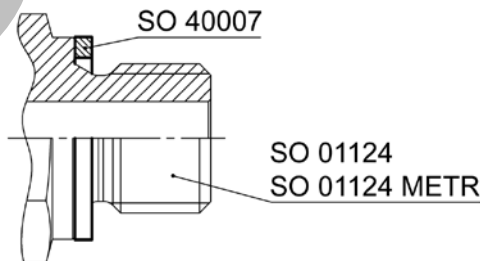
SO 40007 METR

Type -Mz	Mat.-Nr.	D	s	e	kg/100
Mz=metrisches Gewinde (zylindrisch)	Mz=Filetage métrique (cylindrique)	Mz=Metric thread (parallel)			
SO 40007-M5	016.0073.080	8.0	1.00	5.0	0.023
SO 40007-M6	016.0073.100	8.0	1.00	6.2	0.014
SO 40007-M8	016.0073.173	11.2	2.00	8.2	0.080
SO 40007-M10	016.0073.150	13.4	1.50	10.2	0.050
SO 40007-M12	016.0073.190	15.4	1.50	12.2	0.080
SO 40007-M14	016.0073.220	17.9	1.50	14.2	0.110
SO 40007-M16	016.0073.260	19.9	1.50	16.2	0.120
SO 40007-M18	016.0073.300	21.7	1.50	18.2	0.140
SO 40007-M22	016.0073.370	27.0	1.50	22.2	0.225

Anwendungsbeispiele:
Exemples d'utilisation:
Sample combinations:

Material: Kupfer weich
Matériau: Cuivre mou
Material: Soft copper

Ersatzdichtungen für Schwenkverschraubungen und Mehrfachverteiler.

Joints de rechange pour coudes banjo et coudes banjo multiples.

Replacement washer for single and double banjo.

Zu verwenden:

Als Abdichtung der Verschraubung mit zylindrischem Einschraubgewinde.

Emploi:

Rendre étanche à un filetage cylindrique mâle.

Application:

As seal for union with straight male adaptor thread.

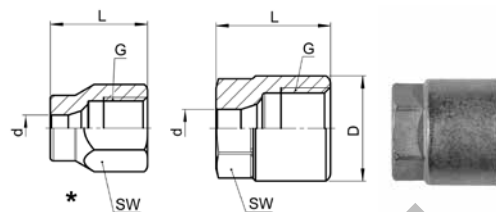
Anschlussmutter
Ecrou
Union nut

SO 00020

Type -d-G	Mat.-Nr.	bar	SW	L	D	kg/100
Für metrische Rohre G=Rohrgewinde (zylindrisch)	Pour tubes métriques G=Filetage-gaz BSP (cylindrique)			For metric tubes G=BSP thread (parallel)		
SO 00020-4-1/8 *	246.0200.060	125	12	15.5	0.0	0.810
SO 00020-5-1/8 *	246.0200.082	125	12	15.5	0.0	0.850
SO 00020-6-1/8 *	246.0200.100	125	12	16.5	0.0	0.840
SO 00020-6-1/4	246.0200.110	125	14	18.5	17.0	1.860
SO 00020-6-3/8	246.0200.120	125	17	21.0	21.0	3.340
SO 00020-8-1/4	246.0200.170	125	14	19.0	17.0	1.800
SO 00020-8-3/8	246.0200.180	125	17	21.0	21.0	3.230
SO 00020-8-1/2	246.0200.185	125	19	23.5	26.0	5.190
SO 00020-10-3/8	246.0200.280	100	17	21.5	21.0	3.000
SO 00020-10-1/2	246.0200.285	100	19	24.0	26.0	5.000
SO 00020-12-1/2	246.0200.400	100	19	26.0	26.0	5.330
SO 00020-14-1/2	246.0200.504	64	22	28.5	26.0	5.760
SO 00020-15-1/2	246.0200.534	64	22	28.5	26.0	5.470

Für Zollrohre	Pour tubes pouces		For inch tubes			
SO 00020-6,35-1/8 *	246.0200.135	125	12	16.5		0.830
SO 00020-6,35-1/4	246.0200.140	125	14	18.5	17.0	1.810
SO 00020-9,52-3/8	246.0200.235	100	17	21.5	21.0	3.050
SO 00020-12,7-1/2	246.0200.434	100	22	27.0	26.0	5.890

Umrechnung für "d" bei Zollrohren:

6,35 = 1/4

9,52 = 3/8

12,7 = 1/2

Conversion de "d" pour tubes en pouces:

6,35 = 1/4

9,52 = 3/8

12,7 = 1/2

Conversion for "d" for inch tubes:

6,35 = 1/4

9,52 = 3/8

12,7 = 1/2

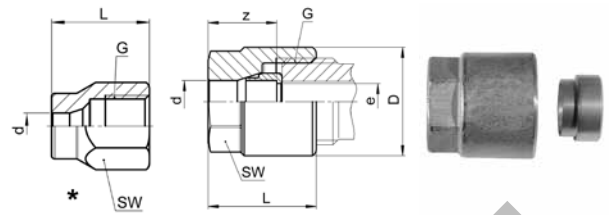
Armaturenanschluss
Ecrou et bague de raccordement
Nut connection

SO 00021

Type -d-G	Mat.-Nr.	bar	SW	L	D	z	e	kg/100
Für metrische Rohre G=Rohrgewinde (zylindrisch)	Pour tubes métriques G=Filetage-gaz BSP (cylindrique)			For metric tubes G=BSP thread (parallel)				
SO 00021-4-1/8 *	246.0210.060	125	12	15.5	0.0	7.0	3.5	0.870
SO 00021-5-1/8 *	246.0210.082	125	12	15.5	0.0	7.0	4.0	0.910
SO 00021-6-1/8 *	246.0210.100	125	12	16.5	0.0	8.0	4.5	0.970
SO 00021-6-1/4	246.0210.110	125	14	18.5	17.0	9.0	4.5	1.980
SO 00021-6-3/8	246.0210.120	125	17	21.0	21.0	11.0	4.5	3.460
SO 00021-8-1/4	246.0210.170	125	14	19.0	17.0	10.0	7.0	1.980
SO 00021-8-3/8	246.0210.180	125	17	21.0	21.0	12.0	7.0	3.420
SO 00021-8-1/2	246.0210.185	125	19	23.5	26.0	11.5	7.0	5.530
SO 00021-10-3/8	246.0210.280	100	17	21.5	21.0	12.0	9.0	3.320
SO 00021-10-1/2	246.0210.285	100	19	24.0	26.0	12.0	9.0	5.410
SO 00021-12-1/2	246.0210.400	100	19	26.0	26.0	13.5	11.0	5.860
SO 00021-14-1/2	246.0210.504	64	22	28.5	26.0	16.0	13.0	6.520
SO 00021-15-1/2	246.0210.534	64	22	28.5	26.0	16.0	14.0	6.210
SO 00021-15-3/4	246.0210.536	64	27	30.0	32.0	17.0	14.0	10.150
Für Zollrohre	Pour tubes pouces			For inch tubes				
SO 00021-6,35-1/8	246.0210.135	125	12	16.5	12.0	8.0	4.5	0.940
SO 00021-6,35-1/4	246.0210.140	125	14	18.5	17.0	9.0	4.5	1.920
SO 00021-7,94-1/4	246.0210.168	125	14	19.0	17.0	10.0	7.0	1.980
SO 00021-9,52-3/8	246.0210.235	100	17	21.5	21.0	12.0	8.0	3.360
SO 00021-12,7-1/2	246.0210.434	100	22	27.0	26.0	14.0	11.0	6.490

Umrechnung für "d" bei Zollrohren:

 6,35 = 1/4
 7,94 = 5/16
 9,52 = 3/8
 12,7 = 1/2

Conversion de "d" pour tubes en pouces:

 6,35 = 1/4
 7,94 = 5/16
 9,52 = 3/8
 12,7 = 1/2

Conversion for "d" for inch tubes:

 6,35 = 1/4
 7,94 = 5/16
 9,52 = 3/8
 12,7 = 1/2

Manometeranschluss
Ecrou de manomètre
Nut connection for pressure gauge

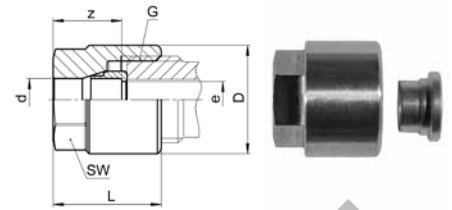

SO 00021 MAN

Type -d -G	Mat.-Nr.	bar	SW	L	D	z	e	kg/100
G=Rohrgewinde (zylindrisch)	G=Filetage-gaz BSP (cylindrique)	G=BSP thread (parallel)						
SO 00021-6-¼ MAN	246.0211.110	125	14	20.0	17.0	8.5	5.5	2.190
SO 00021-6-½ MAN	246.0211.125	125	22	25.5	26.0	8.5	5.0	6.810
SO 00021-8-¼ MAN	246.0211.170	125	14	19.0	17.0	10.5	7.0	2.000
SO 00021-8-½ MAN	246.0211.185	125	22	26.0	26.0	10.0	6.5	6.820
SO 00021-10-½ MAN	246.0211.285	100	19	24.0	26.0	12.0	9.0	5.500
SO 00021-12-½ MAN	246.0211.400	100	19	26.0	26.0	14.0	11.0	5.640

Anwendungsbeispiele:

Exemples d'utilisation:

Sample combinations:

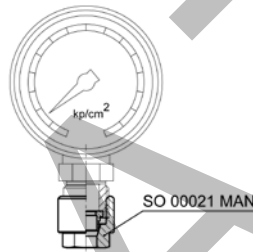

3

**Übergangsmuffe
Adaptateur femelle
Female adaptor**

SO 00030

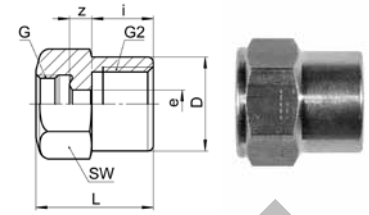

Type -G -G2	Mat.-Nr.	bar	SW	L	D	i	z	e	kg/100
G=Rohrgewinde (zylindrisch)	G=Filetage-gaz BSP (cylindrique)		G=BSP thread (parallel)						
G2=Rohrgewinde (zylindrisch)	G2=Filetage-gaz BSP (cylindrique)		G2=BSP thread (parallel)						
SO 00030-1/8-1/8	246.0301.042	125	14	22.0	14.0	10.0	4.5	4.0	1.820
SO 00030-1/8-1/4	246.0301.044	125	19	23.5	19.0	11.0	5.0	4.0	4.100
SO 00030-1/8-3/8	246.0301.046	125	22	25.0	22.0	12.0	5.5	4.0	8.000
SO 00030-1/8-1/2	246.0301.048	125	27	27.5	27.0	14.0	6.0	4.0	9.470
SO 00030-1/4-1/8	246.0301.102	125	17	22.5	15.0	10.0	4.5	6.0	2.440
SO 00030-1/4-1/4	246.0301.104	125	19	24.0	19.0	11.0	5.0	6.0	2.760
SO 00030-1/4-3/8	246.0301.106	125	22	25.5	22.0	12.0	5.5	6.0	5.370
SO 00030-1/4-1/2	246.0301.108	125	27	28.0	27.0	14.0	6.0	6.0	9.190
SO 00030-3/8-1/4	246.0301.164	100	22	24.5	20.0	11.0	5.0	8.0	4.710
SO 00030-3/8-3/8	246.0301.166	100	24	26.0	24.0	12.0	5.5	8.0	6.410
SO 00030-3/8-1/2	246.0301.168	100	30	28.5	30.0	14.0	6.0	8.0	12.040
SO 00030-1/2-1/4	246.0301.224	100	27	26.5	20.0	11.0	5.0	8.5	6.670
SO 00030-1/2-3/8	246.0301.226	100	27	28.0	25.0	12.0	5.5	10.0	8.000
SO 00030-1/2-1/2	246.0301.228	100	30	30.5	30.0	14.0	6.0	12.0	9.310
SO 00030-1/2-3/4	246.0301.232	100	32	34.0	32.0	17.0	6.5	12.0	11.120

**Übergangsmuffe NPT
Adaptateur femelle NPT
Female adaptor NPT**

SO 00030 NPT

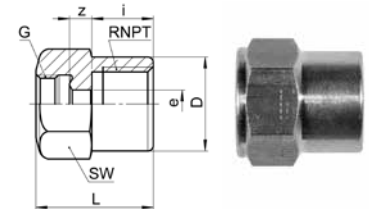

Type -G -RNPT	Mat.-Nr.	bar	SW	L	D	i	z	e	kg/100
G=Rohrgewinde (zylindrisch)	G=Filetage-gaz BSP (cylindrique)		G=BSP thread (parallel)						
RNPT=NPT Gewinde	RNPT=Filetage NPT		RNPT=NPT thread						
SO 00030-1/8-1/8 NPT	246.0302.042	125	14	22.0	14.0	10.0	4.5	4.0	1.850
SO 00030-1/8-1/4 NPT	246.0302.044	125	19	26.5	19.0	14.0	5.0	4.0	4.560
SO 00030-1/4-1/8 NPT	246.0302.102	125	17	22.5	15.0	10.0	4.5	6.0	4.100
SO 00030-1/4-1/4 NPT	246.0302.104	125	19	27.0	19.0	14.0	5.0	6.0	3.760
SO 00030-3/8-1/4 NPT	246.0302.164	100	22	27.5	20.0	14.0	5.0	8.0	4.710
SO 00030-3/8-3/8 NPT	246.0302.166	100	22	27.5	22.0	14.0	5.0	8.0	5.030
SO 00030-1/2-3/8 NPT	246.0302.226	100	27	30.0	24.0	14.0	5.5	10.0	8.650
SO 00030-1/2-1/2 NPT	246.0302.228	100	30	34.0	30.0	18.0	5.5	12.0	12.860

Fortsetzung nächste Seite

Suite à la prochaine page

Continued on next page

Anwendungsbeispiele:

Exemples d'utilisation:

Sample combinations:

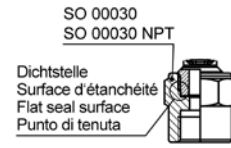
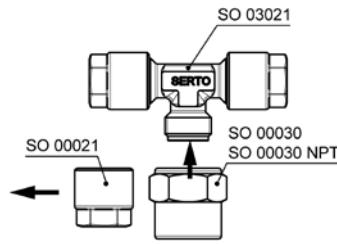
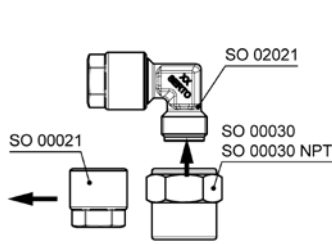

Die Übergangsmuffe kann auf jedes SERTO-Formteil mit dem passenden zylindrischen Gewinde geschraubt werden und muss mit 1/4 Umdrehung angezogen werden.

Dichtungsprinzip: Bei der Montage drückt sich die Dichtkante des Übergangsstückes in das SERTO-Formteil ein, dadurch entsteht eine einwandfreie Dichtung.

Wir empfehlen, das Gewinde mit einem geeigneten Flüssigklebstoff gegen unbeabsichtigtes Lösen zu sichern.

L'adaptateur femelle peut être vissé à toute pièce moulée SERTO avec le filetage cylindrique approprié et doit être serré de 1/4 de tour.

Principe d'étanchéité: Lors de l'assemblage, l'arête d'étanchéité de l'adaptateur appuie sur la pièce moulée SERTO, créant ainsi une étanchéité parfaite.

Nous recommandons de fixer le filetage avec une colle liquide appropriée pour empêcher le desserrage involontaire.

The female adaptor can be screwed onto all SERTO moulded parts with a matching cylindrical thread and must be tightened with 1/4 turn.

Sealing principle: During assembly, the sealing edge of the female adaptor presses into the SERTO moulded part to produce a perfect seal.

We recommend that the thread is secured against accidental unscrewing by means of a suitable liquid adhesive.

Übergangsnippel Adaptateur femelle - mâle Male adaptor

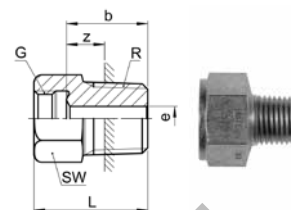
SO 00040

Type -G-R	Mat.-Nr.	bar	SW	L	b	z	e	kg/100
G=Rohrgewinde (zylindrisch)	G=Filetage-gaz BSP (cylindrique)		G=BSP thread (parallel)					
R=Rohrgewinde (kegelig)	R=Filetage-gaz BSP (conique)		R=BSP thread (tapered)					
SO 00040-1/8-1/8	246.0401.042	125	14	18.0	10.5	5.5	4.0	1.200
SO 00040-1/8-1/4	246.0401.044	125	14	22.0	14.5	6.5	4.0	1.960
SO 00040-1/8-3/8	246.0401.046	125	17	24.0	16.5	8.5	4.0	3.820
SO 00040-1/8-1/2	246.0401.048	125	22	28.0	20.5	10.5	4.0	7.680
SO 00040-1/4-1/8	246.0401.102	125	17	20.0	12.0	7.0	5.0	1.780
SO 00040-1/4-1/4	246.0401.104	125	17	24.0	16.0	8.0	6.0	2.600
SO 00040-1/4-3/8	246.0401.106	125	17	24.0	16.0	8.0	6.0	3.160
SO 00040-1/4-1/2	246.0401.108	125	22	28.0	20.0	10.0	6.0	5.820
SO 00040-3/8-1/8	246.0401.162	100	22	22.0	13.5	8.5	4.0	3.650
SO 00040-3/8-1/4	246.0401.164	100	22	26.0	17.5	9.5	8.0	3.620
SO 00040-3/8-3/8	246.0401.166	100	22	26.0	17.5	9.5	8.0	4.430
SO 00040-3/8-1/2	246.0401.168	100	22	28.0	19.5	9.5	8.0	6.040
SO 00040-1/2-1/4	246.0401.224	100	27	28.0	17.5	9.5	7.0	6.160
SO 00040-1/2-3/8	246.0401.226	100	27	28.0	17.5	9.5	10.0	5.950
SO 00040-1/2-1/2	246.0401.228	100	27	30.0	19.5	9.5	12.0	7.080
SO 00040-1/2-3/4	246.0401.232	100	30	32.0	21.5	9.5	12.0	12.080

Übergangsnippel NPT Adaptateur femelle - mâle NPT Male adaptor NPT

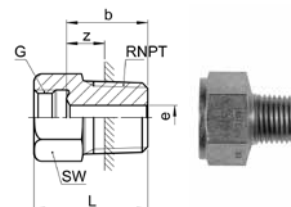
SO 00040 NPT

Type -G-RNPT	Mat.-Nr.	bar	SW	L	b	z	e	kg/100
G=Rohrgewinde (zylindrisch)	G=Filetage-gaz BSP (cylindrique)		G=BSP thread (parallel)					
RNPT=NPT Gewinde	RNPT=Filetage NPT		RNPT=NPT thread					
SO 00040-1/8-1/8 NPT	246.0402.042	125	14	20.0	12.5	5.5	4.0	1.270
SO 00040-1/8-1/4 NPT	246.0402.044	125	14	24.0	16.5	6.5	4.0	1.960
SO 00040-1/4-1/8 NPT	246.0402.102	125	17	22.0	14.0	7.0	5.0	1.830
SO 00040-1/4-1/4 NPT	246.0402.104	125	17	26.0	18.0	8.0	6.0	2.690
SO 00040-1/4-3/8 NPT	246.0402.106	125	17	27.0	18.0	8.0	6.0	3.490
SO 00040-3/8-1/4 NPT	246.0402.164	100	22	28.0	19.5	9.5	8.0	3.820
SO 00040-3/8-3/8 NPT	246.0402.166	100	22	28.0	19.5	9.5	8.0	4.800
SO 00040-1/2-3/8 NPT	246.0402.226	100	27	30.0	19.5	9.5	10.0	6.250
SO 00040-1/2-1/2 NPT	246.0402.228	100	27	35.0	24.5	10.5	12.0	7.980

Fortsetzung nächste Seite

Suite à la prochaine page

Continued on next page

Übergangsnippel METR

Adaptateur femelle - mâle METR

Male adaptor METR

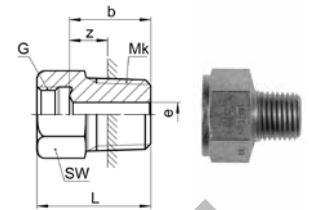

SO 00040 METR

Type -G -Mk	Mat.-Nr.	bar	SW	L	b	z	e	kg/100
G=Rohrgewinde (zylindrisch)	G=Filetage-gaz BSP (cylindrique)							
Mk=metrisches Gewinde (kegelig)	Mk=Filetage métrique (conique)							
SO 00040-1/8"-M10x1 k	246.0403.040	125	14	18.0	10.5	5.5	5.0	1.700
SO 00040-1/4"-M12x1,5 k	246.0403.085	125	17	24.0	16.0	8.0	6.0	2.210
SO 00040-3/8"-M14x1,5 k	246.0403.125	100	22	26.0	17.5	9.5	8.0	3.860
SO 00040-1/2"-M16x1,5 k	246.0403.165	100	27	28.0	17.5	9.5	10.0	5.720

Anwendungsbeispiele:

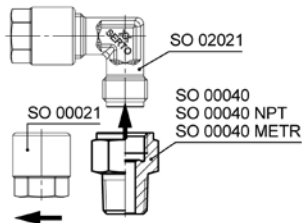

Der Übergangsnippel kann auf jedes SERTO-Formteil mit dem passenden zylindrischen Gewinde geschraubt werden und muss mit 1/4 Umdrehung angezogen werden.

Dichtungsprinzip: Bei der Montage drückt sich die Dichtkante des Übergangsstückes in das SERTO-Formteil ein, dadurch entsteht eine einwandfreie Dichtung. Wir empfehlen, das Gewinde mit einem geeigneten Flüssigklebstoff gegen unbeabsichtigtes Lösen zu sichern.

Exemples d'utilisation:

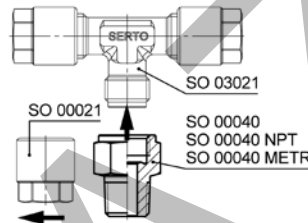

L'adaptateur mâle peut être vissé à toute pièce moulée SERTO avec le filetage cylindrique approprié et doit être serré de 1/4 de tour.

Principe d'étanchéité: Lors de l'assemblage, l'arête d'étanchéité de l'adaptateur appuie sur la pièce moulée SERTO, créant ainsi une étanchéité parfaite. Nous recommandons de fixer le filetage avec une colle liquide appropriée pour empêcher le desserrage involontaire.

Sample combinations:

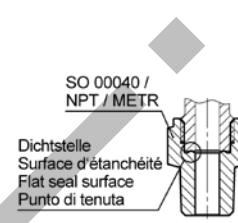

The male adaptor can be screwed onto all SERTO moulded parts with a matching cylindrical thread and must be tightened with 1/4 turn.

Sealing principle: During assembly, the sealing edge of the male adaptor presses into the SERTO moulded part to produce a perfect seal. We recommend that the thread is secured against accidental unscrewing by means of a suitable liquid adhesive.

Anschlussnippel

Ecrou de raccordement mâle

Nipple connection

SO 01001

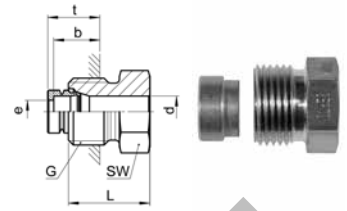

Type -d-G	Mat.-Nr.	bar	SW	L	b	t	e	kg/100
Für metrische Rohre G=Rohrgewinde (zylindrisch)	Pour tubes métriques G=Filetage-gaz BSP (cylindrique)			For metric tubes G=BSP thread (parallel)				
SO 41001-4-1/8	016.1001.060	125	10	12.0	6.0	7.0	3.4	0.590
SO 41001-5-1/8	016.1001.082	125	10	12.0	6.0	7.0	4.0	0.530
SO 41001-6-1/4	016.1001.110	250	14	16.0	8.5	9.5	4.5	1.430
SO 01001-8-1/4	246.1001.170	125	14	16.0	8.5	9.5	6.5	1.160
SO 01001-10-3/8	246.1001.280	100	17	17.0	9.0	10.0	9.0	1.900
SO 01001-12-1/2	246.1001.400	100	19	19.0	12.5	14.0	11.0	2.980
SO 01001-14-1/2	246.1001.504	64	22	20.5	12.5	14.0	13.0	3.600
SO 01001-15-3/4	246.1001.536	64	27	22.0	9.5	11.0	14.0	6.730
Für Zollrohre	Pour tubes pouces			For inch tubes				
SO 41001-6,35-1/4	016.1001.140	250	14	16.0	8.5	9.5	4.5	1.400
SO 01001-9,52-3/8	246.1001.235	125	17	17.0	9.0	10.0	8.0	2.100
SO 01001-12,7-1/2	246.1001.434	100	22	20.0	10.0	11.0	11.0	3.750

Umrechnung für "d" bei Zollrohren:
 6,35 = 1/4
 9,52 = 3/8
 12,7 = 1/2

Conversion de "d" pour tubes en pouces:
 6,35 = 1/4
 9,52 = 3/8
 12,7 = 1/2

Conversion for "d" for inch tubes:
 6,35 = 1/4
 9,52 = 3/8
 12,7 = 1/2

Anschlussnippel METR

Ecrou de raccordement mâle METR

Nipple connection METR

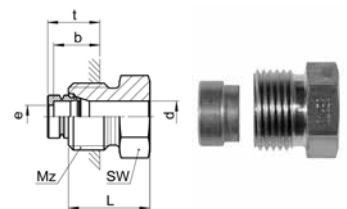

SO 01001 METR

Type -d-Mz	Mat.-Nr.	bar	SW	L	b	t	e	kg/100
Für metrische Rohre Mz=metrisches Gewinde (zylindrisch)	Pour tubes métriques Mz=Filetage métrique (cylindrique)			For metric tubes Mz=Metric thread (parallel)				
SO 01001-4-M8x0,75	246.1003.088	125	8	10.5	6.0	7.0	3.5	0.320
SO 01001-6-M11x0,75	246.1003.183	100	12	13.5	8.5	9.5	4.5	0.850

Anwendungsbeispiele:

Exemples d'utilisation:

Sample combinations:

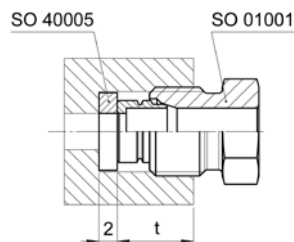

Die entsprechende Kupferdichtung SO 40005 ist immer separat zu bestellen.

Le joint de cuivre correspondant SO 40005 doit toujours être commandé séparément.

The matching copper seal SO 40005 must always be ordered separately.

Gerade Verschraubung

Union double

Straight union

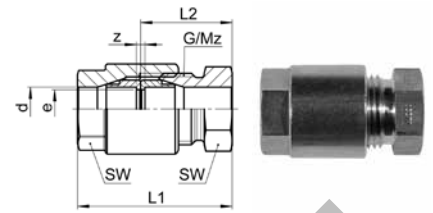

SO 01011

Type -d	Mat.-Nr.	bar	SW	G	L1	L2	z	e	kg/100
Für metrische Rohre	Pour tubes métriques			For metric tubes					
SO 01011-4	248.1010.040	125	8	M8x0.75	19.0	12.0	2.0	3.5	0.860
SO 01011-5	248.1010.050	125	10	1/8	22.5	14.0	2.0	4.0	1.350
SO 01011-6	248.1010.060	125	12	M11x0.75	26.0	16.5	2.4	4.5	2.030
SO 01011-8	248.1010.080	125	14	1/4	28.5	18.0	2.0	7.0	3.430
SO 01011-10	248.1010.100	100	17	3/8	31.5	19.0	2.0	9.0	5.560
SO 01011-12	248.1010.120	100	19	1/2	35.0	19.0	2.4	11.0	8.840
SO 01011-14	248.1010.140	64	22	1/2	42.0	25.0	3.0	13.0	10.800
SO 01011-15	248.1010.150	64	27	3/4	40.5	22.5	3.0	14.0	16.960
Für Zollrohre	Pour tubes pouces			For inch tubes					
SO 01011-6,35	248.1010.063	125	14	1/4	28.5	18.0	2.0	4.5	2.010
SO 01011-9,52	248.1010.095	100	17	3/8	32.0	19.0	2.0	8.0	5.860
SO 01011-12,7	248.1010.127	100	22	1/2	37.0	21.5	2.4	11.0	9.620

Umrechnung für "d" bei Zollrohren:

6,35 = 1/4
9,52 = 3/8
12,7 = 1/2

Conversion de "d" pour tubes en pouces:

6,35 = 1/4
9,52 = 3/8
12,7 = 1/2

Conversion for "d" for inch tubes:

6,35 = 1/4
9,52 = 3/8
12,7 = 1/2

Die Mutter der geraden Verschraubung SO 01011 darf nicht mit dem Armaturenanschluss SO 00021 ausgetauscht werden. Für das Verbinden von Rohren verschiedener Qualitäten bzw. Werkstoffe ist die Gerade Verschraubung SO 01021 zu verwenden.

Montage:

Abweichend zur generellen Montageanleitung sind für diese Verschraubung **2 1/4**

Umdrehungen für eine korrekte Montage nötig.

L'écrou femelle de l'union double SO 01011 ne doit pas être échangé contre l'écrou SO 00021. Pour le raccordement des tubes de qualités différentes, utiliser l'union double SO 01021.

Assemblage:

Contrairement aux instructions de montage générale, pour ce raccord **2 1/4 tours** sont nécessaires pour une installation correcte.

The nut of the straight union SO 01011 must not be exchanged with the nut connection SO 00021. To connect tubes of differing quality or materials, use the straight union SO 01021.

Assembly:

Deviating from the general assembly instruction, for this union **2 1/4 rotations** are necessary for proper assembly.

Gerade Verschraubung
Union double
Straight union

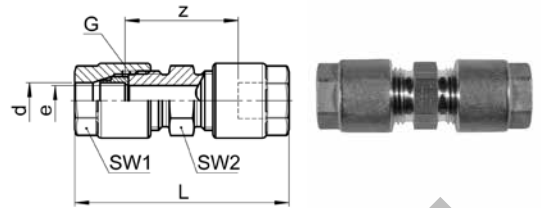

SO 01021

Type -d	Mat.-Nr.	bar	G	SW1	SW2	L	z	e	kg/100
Für metrische Rohre	Pour tubes métriques		For metric tubes						
SO 01021-4	248.1020.040	125	1/8	12	12	41.5	28.0	4.5	3.020
SO 01021-5	248.1020.050	125	1/8	12	12	41.5	28.0	4.5	3.110
SO 01021-6	248.1020.060	125	1/8	12	12	44.5	28.5	4.5	3.230
SO 01021-8	248.1020.080	125	1/4	14	14	49.0	30.5	6.5	6.040
SO 01021-10	248.1020.100	100	3/8	17	17	56.0	32.0	8.5	10.220
SO 01021-12	248.1020.120	100	1/2	19	22	65.0	38.5	12.0	17.770
SO 01021-14	248.1020.140	64	1/2	22	22	71.0	39.0	12.0	19.100
SO 01021-15	248.1020.150	64	1/2	22	22	71.0	39.0	12.0	18.480
Für Zollrohre	Pour tubes pouces		For inch tubes						
SO 01021-6,35	248.1020.063	125	1/8	12	12	44.5	28.0	4.5	3.160
SO 01021-9,52	248.1020.095	100	3/8	17	17	61.0	32.0	8.5	10.310
SO 01021-12,7	248.1020.127	100	1/2	22	22	71.0	39.0	12.0	19.030

Umrechnung für "d" bei Zollrohren:

- 6,35 = 1/4
- 9,52 = 3/8
- 12,7 = 1/2

Conversion de "d" pour tubes en pouces:

- 6,35 = 1/4
- 9,52 = 3/8
- 12,7 = 1/2

Conversion for "d" for inch tubes:

- 6,35 = 1/4
- 9,52 = 3/8
- 12,7 = 1/2

d=Rohrassens-ø
 e=kleinste Bohrung
 L=Mass in montiertem Zustand

d=ø extérieur du tube
 e=ø-min. de passage
 L=après montage

d=tube outside diameter
 e=minimum bore
 L=installed length

Gerade Verschraubung reduziert
Union double réduite
Straight reduction union

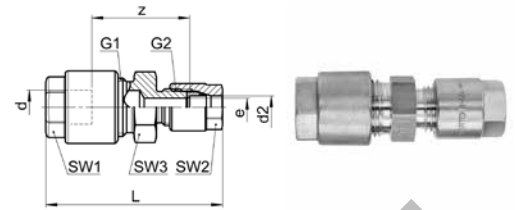

SO 01021 RED

Type -d -d2	Mat.-Nr.	bar	G1	G2	SW1	SW2	SW3	L	z	e	kg/100	
Für metrische Rohre	Pour tubes métriques			For metric tubes								
SO 01021-6-4	248.1024.110	125	1/8	1/8	12	12	12	43.0	28.0	4.5	3.130	
SO 01021-8-6	248.1024.140	125	1/4	1/8	14	12	14	46.5	29.0	4.5	4.950	
SO 01021-10-8	248.1024.190	100	3/8	1/4	17	14	17	53.0	31.5	6.5	8.740	
SO 01021-12-8	248.1024.225	100	1/2	1/4	19	14	22	58.0	35.0	6.5	12.990	
SO 01021-12-10	248.1024.240	100	1/2	3/8	19	17	22	61.0	35.5	8.5	15.500	
SO 01021-14-8	248.1024.300	64	1/2	1/4	22	14	22	61.0	35.5	6.5	13.650	
SO 01021-14-12	248.1024.340	64	1/2	1/2	22	19	22	68.0	39.0	12.0	18.430	
SO 01021-15-8	248.1024.400	64	1/2	1/4	22	14	22	61.0	35.5	6.5	13.340	
SO 01021-15-10	248.1024.410	64	1/2	1/2	22	19	22	63.5	36.0	12.0	15.860	
SO 01021-15-12	248.1024.420	64	1/2	1/2	22	19	22	68.0	39.0	12.0	18.130	

Für Zollrohre	Pour tubes pouces			For inch tubes								
SO 01021-6,35-4	248.1024.123	125	1/8	1/8	12	12	12	43.0	28.0	4.5	3.090	
SO 01021-6,35-5	248.1024.126	125	1/8	1/8	12	12	12	43.0	28.0	4.5	3.140	
SO 01021-6,35-6	248.1024.128	125	1/8	1/8	12	12	12	44.5	28.5	4.5	3.200	
SO 01021-10-9,52	248.1024.197	100	3/8	3/8	17	17	17	56.0	32.0	8.5	10.270	

Umrechnung für "d" bei Zollrohren:
 6,35 = 1/4
 9,52 = 3/8

Conversion de "d" pour tubes en pouces:
 6,35 = 1/4
 9,52 = 3/8

Conversion for "d" for inch tubes:
 6,35 = 1/4
 9,52 = 3/8

d=Rohrassens-ø
 e=kleinste Bohrung
 L=Mass in montiertem Zustand

d=ø extérieur du tube
 e=ø-min. de passage
 L=après montage

d=tube outside diameter
 e=minimum bore
 L=installed length

Gerade Einschraubverschraubung

Union mâle

Male adaptor union

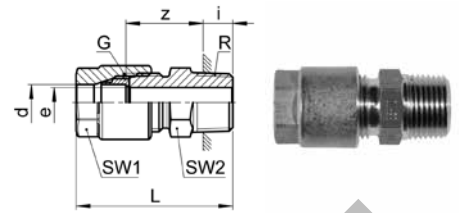

SO 01121

Type -d-R	Mat.-Nr.	bar	G	SW1	SW2	L	i	z	e	kg/100
Für metrische Rohre R=Rohrgewinde (kegelig)	Pour tubes métriques R=Filetage-gaz BSP (conique)	For metric tubes R=BSP thread (tapered)								
SO 01121-4-1/8	248.1101.060	125	1/8	12	10	30.0	5.0	18.0	4.0	1.880
SO 01121-4-1/4	248.1101.065	125	1/8	12	14	36.0	8.0	21.0	4.0	2.820
SO 01121-5-1/8	248.1101.082	125	1/8	12	10	30.0	5.0	18.0	4.0	1.930
SO 01121-5-1/4	248.1101.084	125	1/8	12	14	36.0	8.0	21.0	4.0	2.860
SO 01121-6-1/8	248.1101.100	125	1/8	12	10	31.0	5.0	18.5	4.0	1.990
SO 01121-6-1/4	248.1101.110	125	1/8	12	14	37.0	8.0	21.5	4.0	2.930
SO 01121-6-3/8	248.1101.120	125	1/8	12	17	37.0	8.0	21.5	4.0	3.540
SO 01121-6-1/2	248.1101.125	125	1/4	14	22	44.5	10.0	26.0	5.0	19.980
SO 01121-8-1/8	248.1101.160	125	1/4	14	14	35.5	5.0	21.0	5.0	3.880
SO 01121-8-1/4	248.1101.170	125	1/4	14	14	39.5	8.0	22.0	6.4	4.390
SO 01121-8-3/8	248.1101.180	125	1/4	14	17	39.5	8.0	22.0	6.4	4.810
SO 01121-8-1/2	248.1101.185	125	1/4	14	22	44.5	10.0	25.0	6.4	6.840
SO 01121-10-1/4	248.1101.270	100	3/8	17	17	42.5	8.0	22.5	8.4	6.170
SO 01121-10-3/8	248.1101.280	100	3/8	17	17	42.5	8.0	22.5	8.4	6.920
SO 01121-10-1/2	248.1101.285	100	3/8	17	22	47.5	10.0	25.5	8.4	8.520
SO 01121-12-1/4	248.1101.380	100	1/2	19	22	47.5	8.0	26.5	8.0	11.490
SO 01121-12-3/8	248.1101.390	100	1/2	19	22	47.5	8.0	26.5	10.0	11.470
SO 01121-12-1/2	248.1101.400	100	1/2	19	22	51.5	10.0	28.5	12.0	12.330
SO 01121-12-3/4	248.1101.405	100	1/2	19	27	53.5	12.0	30.5	12.0	14.710
SO 01121-14-3/8	248.1101.502	64	1/2	22	22	50.5	8.0	26.5	10.0	12.130
SO 01121-14-1/2	248.1101.504	64	1/2	22	22	54.5	10.0	28.5	12.0	12.990
SO 01121-14-3/4	248.1101.506	64	1/2	22	27	56.5	12.0	30.5	12.0	15.370
SO 01121-15-3/8	248.1101.532	64	1/2	22	22	50.5	8.0	26.5	10.0	11.820
SO 01121-15-1/2	248.1101.534	64	1/2	22	22	54.5	10.0	28.5	12.0	12.680
SO 01121-15-3/4	248.1101.536	64	1/2	22	27	56.5	12.0	30.5	12.0	15.060
Für Zollrohre	Pour tubes pouces	For inch tubes								
SO 01121-6,35-1/8	248.1101.135	125	1/8	12	12	33.0	5.0	18.5	4.0	1.960
SO 01121-6,35-1/4	248.1101.140	125	1/8	12	14	38.0	8.0	21.5	4.0	2.890
SO 01121-6,35-3/8	248.1101.145	125	1/8	12	17	38.0	8.0	21.5	4.0	3.500
SO 01121-9,52-1/4	248.1101.230	100	3/8	17	17	44.0	8.0	22.5	8.4	6.210
SO 01121-9,52-3/8	248.1101.235	100	3/8	17	17	44.0	8.0	22.5	8.4	6.970
SO 01121-9,52-1/2	248.1101.240	100	3/8	17	22	47.0	10.0	25.5	8.4	8.560
SO 01121-12,7-1/4	248.1101.430	100	1/2	19	22	50.0	8.0	26.5	8.0	12.120
SO 01121-12,7-3/8	248.1101.432	100	1/2	19	22	50.0	8.0	26.5	10.0	12.100
SO 01121-12,7-1/2	248.1101.434	100	1/2	19	22	52.0	10.0	28.5	12.0	12.960
SO 01121-12,7-3/4	248.1101.436	100	1/2	19	27	55.0	12.0	30.5	12.0	15.340

Umrechnung für "d" bei Zollrohren:

 6,35 = 1/4
 9,52 = 3/8
 12,7 = 1/2

Conversion de "d" pour tubes en pouces:

 6,35 = 1/4
 9,52 = 3/8
 12,7 = 1/2

Conversion for "d" for inch tubes:

 6,35 = 1/4
 9,52 = 3/8
 12,7 = 1/2

**Gerade Einschraubverschraubung NPT
Union mâle NPT
Male adaptor union NPT**

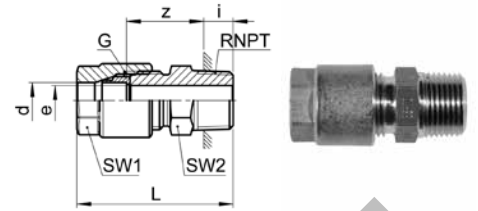

SO 01121 NPT

Type -d -RNPT	Mat.-Nr.	bar	G	SW1	SW2	L	i	z	e	kg/100
Für metrische Rohre RNPT=NPT Gewinde	Pour tubes métriques RNPT=Filetage NPT									
SO 01121-4-1/8 NPT	248.1102.060	125	1/8	12	12	33.0	7.0	19.0	4.0	2.230
SO 01121-4-1/4 NPT	248.1102.065	125	1/8	12	14	38.0	10.0	21.0	4.0	3.380
SO 01121-5-1/8 NPT	248.1102.082	125	1/8	12	12	33.0	7.0	19.0	4.0	2.280
SO 01121-5-1/4 NPT	248.1102.084	125	1/8	12	14	38.0	10.0	21.0	4.0	3.420
SO 01121-6-1/8 NPT	248.1102.100	125	1/8	12	12	34.5	7.0	19.5	4.0	2.340
SO 01121-6-1/4 NPT	248.1102.110	125	1/8	12	14	39.0	10.0	21.5	4.0	3.490
SO 01121-6-3/8 NPT	248.1102.120	125	1/8	12	17	39.0	10.0	21.5	4.0	4.730
SO 01121-6-1/2 NPT	248.1102.125	125	3/8	17	22	50.5	14.0	25.5	5.0	9.840
SO 01121-8-1/8 NPT	248.1102.160	125	1/4	14	14	37.5	7.0	21.0	6.4	3.790
SO 01121-8-1/4 NPT	248.1102.170	125	1/4	14	14	41.5	10.0	22.0	6.4	4.430
SO 01121-8-3/8 NPT	248.1102.180	125	1/4	14	17	41.5	10.0	22.0	6.4	5.250
SO 01121-10-1/4 NPT	248.1102.270	100	3/8	17	17	44.5	10.0	22.5	8.0	6.450
SO 01121-10-3/8 NPT	248.1102.280	100	3/8	17	17	44.5	10.0	22.5	8.4	7.360
SO 01121-10-1/2 NPT	248.1102.285	100	3/8	17	22	50.5	14.0	24.5	8.4	9.630
SO 01121-12-3/8 NPT	248.1102.390	100	1/2	19	22	49.5	10.0	26.5	10.0	11.730
SO 01121-12-1/2 NPT	248.1102.400	100	1/2	19	22	54.5	14.0	27.5	12.0	12.790
SO 01121-14-3/8 NPT	248.1102.502	64	1/2	22	22	49.5	10.0	26.5	10.0	12.390
SO 01121-14-1/2 NPT	248.1102.504	64	1/2	22	22	54.5	14.0	27.5	12.0	13.450
SO 01121-15-3/8 NPT	248.1102.532	64	1/2	22	22	49.5	10.0	26.5	10.0	12.080
SO 01121-15-1/2 NPT	248.1102.534	64	1/2	22	22	54.5	14.0	27.5	12.0	13.140

Für Zollrohre	Pour tubes pouces									
SO 01121-6,35-1/8 NPT	248.1102.135	125	1/8	12	12	34.5	7.0	19.5	4.0	2.310
SO 01121-6,35-1/4 NPT	248.1102.140	125	1/8	12	14	39.5	10.0	21.5	4.0	3.450
SO 01121-9,52-1/4 NPT	248.1102.230	100	3/8	17	17	44.5	10.0	22.5	8.0	6.490
SO 01121-9,52-3/8 NPT	248.1102.235	100	3/8	17	17	44.5	10.0	22.5	8.4	7.400
SO 01121-9,52-1/2 NPT	248.1102.240	100	3/8	17	22	50.5	14.0	24.5	8.4	9.670
SO 01121-12,7-3/8 NPT	248.1102.432	100	1/2	22	22	50.5	10.0	26.5	10.0	12.360
SO 01121-12,7-1/2 NPT	248.1102.434	100	1/2	22	22	55.5	14.0	27.5	12.0	13.420

Umrechnung für "d" bei Zollrohren:
 6,35 = 1/4
 9,52 = 3/8
 12,7 = 1/2

Conversion de "d" pour tubes en pouces:
 6,35 = 1/4
 9,52 = 3/8
 12,7 = 1/2

Conversion for "d" for inch tubes:
 6,35 = 1/4
 9,52 = 3/8
 12,7 = 1/2

Gerade Einschraubverschraubung

mit Dichtkante

Union mâle

avec arête d'étanchéité

Male adaptor union

with edge seal

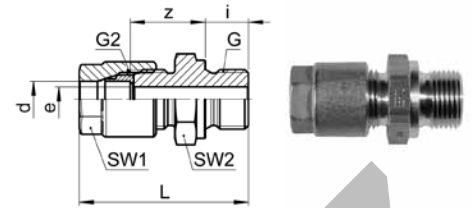

SO 01124

Type -d-G	Mat.-Nr.	bar	G2	SW1	SW2	L	D	i	t	z	e	kg/100
Für metrische Rohre	Pour tubes métriques						For metric tubes					
G=Rohrgewinde (zylindrisch)	G=Filetage-gaz BSP (cylindrique)						G=BSP thread (parallel)					
SO 01124-4-1/8	248.1141.060	125	1/8	12	14	31.5	14.5	8.0	1.0	16.5	4.0	2.310
SO 01124-5-1/8	248.1141.082	125	1/8	12	14	31.5	14.5	8.0	1.0	16.5	4.0	2.350
SO 01124-6-1/8	248.1141.100	125	1/8	12	14	33.0	14.5	8.0	1.0	17.0	4.0	2.410
SO 01124-6-1/4	248.1141.110	125	1/8	12	19	39.0	18.5	12.0	1.5	18.0	4.0	4.090
SO 01124-8-1/8	248.1141.160	125	1/4	14	14	35.0	14.5	8.0	1.0	17.5	5.0	3.760
SO 01124-8-1/4	248.1141.170	125	1/4	14	19	40.5	18.5	12.0	1.5	19.0	6.0	5.170
SO 01124-8-3/8	248.1141.180	125	1/4	14	22	43.5	22.5	12.0	2.0	20.5	6.0	7.030
SO 01124-10-1/4	248.1141.270	100	3/8	17	19	43.5	18.5	12.0	1.5	19.5	7.0	7.030
SO 01124-10-3/8	248.1141.280	100	3/8	17	22	45.0	22.5	12.0	2.0	21.0	7.0	8.870
SO 01124-12-1/4	248.1141.380	100	1/2	19	22	49.0	22.5	12.0	1.5	23.5	7.0	11.930
SO 01124-12-3/8	248.1141.390	100	1/2	19	22	49.0	22.5	12.0	2.0	23.5	9.0	12.170
SO 01124-12-1/2	248.1141.400	100	1/2	19	27	52.5	27.0	14.0	2.5	25.0	12.0	14.190
SO 01124-14-3/8	248.1141.502	64	1/2	22	22	47.5	22.5	12.0	2.0	24.0	9.0	12.830
SO 01124-14-1/2	248.1141.504	64	1/2	22	27	52.5	27.0	14.0	2.5	25.5	12.0	14.850
SO 01124-15-3/8	248.1141.532	64	1/2	22	22	52.0	22.5	12.0	2.0	24.0	9.0	12.520
SO 01124-15-1/2	248.1141.534	64	1/2	22	27	55.5	27.0	14.0	2.5	25.5	12.0	14.540
Für Zollrohre	Pour tubes pouces						For inch tubes					
SO 01124-6,35-1/8	248.1141.135	125	1/4	14	14	38.5	14.5	8.0	1.0	22.0	4.0	2.380
SO 01124-6,35-1/4	248.1141.140	125	1/8	12	19	39.0	18.5	12.0	1.5	18.0	4.0	4.050
SO 01124-9,52-1/4	248.1141.230	100	3/8	17	19	43.5	18.5	12.0	1.5	19.5	7.0	7.070
SO 01124-9,52-3/8	248.1141.235	100	3/8	17	22	45.0	22.5	12.0	2.0	21.0	7.0	8.920
SO 01124-12,7-3/8	248.1141.432	100	1/2	22	22	50.0	22.5	12.0	2.0	24.0	9.0	12.800

Umrechnung für "d" bei Zollrohren:

6,35 = 1/4
9,52 = 3/8
12,7 = 1/2

Conversion de "d" pour tubes en pouces:

6,35 = 1/4
9,52 = 3/8
12,7 = 1/2

Conversion for "d" for inch tubes:

6,35 = 1/4
9,52 = 3/8
12,7 = 1/2

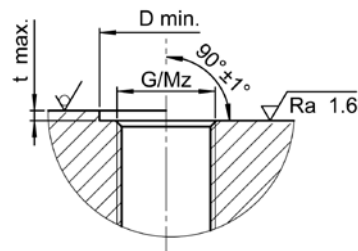
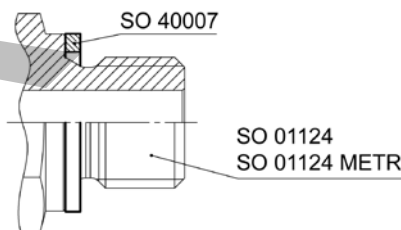

Bei Bedarf ist die entsprechende Dichtung SO 40007 / SO 40507 separat zu bestellen.

Si nécessaire, le joint approprié SO 40007 / SO 40507 doit être commandé séparément.

If necessary, the matching washer SO 40007 / SO 40507 must be ordered separately.

Gerade Einschraubverschraubung METR

mit Dichtkante

Union mâle METR

avec arête d'étanchéité

Male adaptor union METR

with edge seal

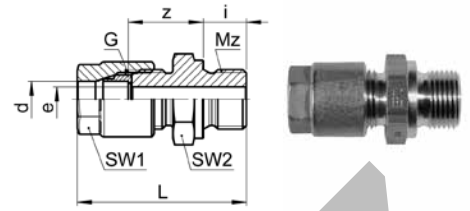

SO 01124 METR

Type -d -Mz	Mat.-Nr.	bar	G	SW1	SW2	L	D	i	t	z	e	kg/100
Für metrische Rohre	Pour tubes métriques						For metric tubes					
Mz=metrisches Gewinde (zylindrisch)	Mz=Filetage métrique (cylindrique)						Mz=Metric thread (parallel)					
SO 01124-4-M10x1	248.1143.096	125	1/8	12	14	31.0	14.5	8.0	1.0	16.5	4.0	2.320
SO 01124-5-M10x1	248.1143.135	125	1/8	12	14	31.5	14.5	8.0	1.0	16.5	4.0	2.370
SO 01124-6-M10x1	248.1143.180	125	1/8	12	14	32.5	14.5	8.0	1.0	17.0	4.0	2.430
SO 01124-8-M12x1,5	248.1143.240	125	1/4	14	17	40.5	17.5	12.0	1.5	19.0	6.0	4.590
SO 01124-8-M14x1,5	248.1143.245	125	1/4	14	19	40.5	19.5	12.0	1.5	19.0	6.0	5.310
SO 01124-10-M14x1,5	248.1143.280	100	3/8	17	19	43.5	19.5	12.0	1.5	19.5	7.0	7.140
SO 01124-12-M16x1,5	248.1143.330	100	1/2	19	22	49.5	21.5	12.0	1.5	24.0	9.0	12.030
SO 01124-12-M22x1,5	248.1143.338	100	1/2	19	27	52.5	28.0	14.0	2.5	25.0	9.0	14.400
SO 01124-14-M22x1,5	248.1143.385	64	1/2	22	27	55.5	28.0	14.0	2.5	25.5	9.0	15.050
SO 01124-15-M22x1,5	248.1143.395	64	1/2	22	27	55.5	28.0	14.0	2.5	25.5	9.0	14.750

Für Zollrohre	Pour tubes pouces						For inch tubes					
SO 01124-6,35-M10x1	248.1143.210	125	1/8	12	14	32.5	14.5	8.0	1.0	16.5	4.0	2.390
SO 01124-9,52-M14x1,5	248.1143.265	125	3/8	17	19	43.5	19.5	12.0	1.5	19.5	7.0	7.180
SO 01124-12,7-M16x1,5	248.1143.350	100	1/2	22	22	50.5	21.5	12.0	1.5	24.0	9.0	12.650
SO 01124-12,7-M22x1,5	248.1143.358	100	1/2	22	27	53.5	28.0	14.0	2.5	25.0	9.0	15.020

Umrechnung für "d" bei Zollrohren:

6,35 = 1/4
9,52 = 3/8
12,7 = 1/2

Conversion de "d" pour tubes en pouces:

6,35 = 1/4
9,52 = 3/8
12,7 = 1/2

Conversion for "d" for inch tubes:

6,35 = 1/4
9,52 = 3/8
12,7 = 1/2

Anwendungsbeispiele:

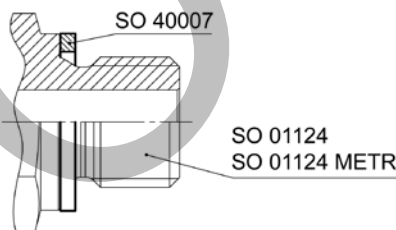

Bei Bedarf ist die entsprechende Dichtung SO 40007 / SO 40507 separat zu bestellen.

Exemples d'utilisation:

Si nécessaire, le joint approprié SO 40007 / SO 40507 doit être commandé séparément.

Sample combinations:

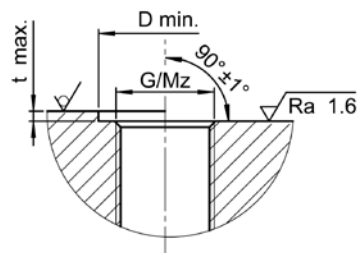

If necessary, the matching washer SO 40007 / SO 40507 must be ordered separately.

Gerade Aufschraubverschraubung

Union femelle

Female adaptor union

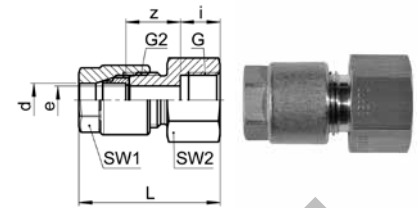

SO 01221

Type -d-G	Mat.-Nr.	bar	G2	SW1	SW2	L	i	z	e	kg/100
Für metrische Rohre G=Rohrgewinde (zylindrisch)	Pour tubes métriques G=Filetage-gaz BSP (cylindrique)		For metric tubes G=BSP thread (parallel)							
SO 01221-4-1/8	248.1201.060	125	1/8	12	14	31.0	10.0	14.0	4.0	2.470
SO 01221-4-1/4	248.1201.065	125	1/8	12	17	32.5	11.0	15.0	4.0	3.200
SO 01221-5-1/8	248.1201.082	125	1/8	12	14	31.0	10.0	14.0	4.0	2.510
SO 01221-5-1/4	248.1201.084	125	1/8	12	17	34.0	11.0	15.0	4.0	3.250
SO 01221-6-1/8	248.1201.100	125	1/8	12	14	32.0	10.0	14.0	4.0	2.600
SO 01221-6-1/4	248.1201.110	125	1/8	12	17	34.0	11.0	15.0	4.0	3.310
SO 01221-6-3/8	248.1201.120	125	1/8	12	22	35.0	12.0	15.0	4.0	4.920
SO 01221-8-1/8	248.1201.160	125	1/4	14	14	34.5	10.0	15.0	6.5	3.870
SO 01221-8-1/4	248.1201.170	125	1/4	14	17	36.5	11.0	16.0	6.5	4.580
SO 01221-8-3/8	248.1201.180	125	1/4	14	22	37.5	12.0	16.0	6.5	6.170
SO 01221-8-1/2	248.1201.185	125	1/4	14	27	39.5	14.0	16.0	6.5	8.410
SO 01221-10-1/4	248.1201.270	100	3/8	17	17	39.5	11.0	16.5	8.5	6.330
SO 01221-10-3/8	248.1201.280	100	3/8	17	22	40.5	12.0	16.5	8.5	7.970
SO 01221-10-1/2	248.1201.285	100	3/8	17	27	43.0	14.0	17.0	8.5	10.320
SO 01221-10-3/4	248.1201.290	100	3/8	17	32	46.0	17.0	20.0	8.0	13.100
SO 01221-12-3/8	248.1201.390	100	1/2	19	22	44.5	12.0	19.0	10.5	11.520
SO 01221-12-1/2	248.1201.400	100	1/2	19	27	47.0	14.0	19.5	12.5	13.310
SO 01221-12-3/4	248.1201.405	100	1/2	19	32	50.0	17.0	19.5	12.0	16.690
SO 01221-14-3/8	248.1201.502	64	1/2	22	22	47.5	12.0	19.5	10.5	12.180
SO 01221-14-1/2	248.1201.504	64	1/2	22	27	50.0	14.0	20.0	12.5	13.970
SO 01221-14-3/4	248.1201.506	64	1/2	22	32	53.0	17.0	20.0	12.0	17.350
SO 01221-15-3/8	248.1201.532	64	1/2	22	22	47.5	12.0	19.5	10.5	11.870
SO 01221-15-1/2	248.1201.534	64	1/2	22	27	50.0	14.0	20.0	12.5	13.660
SO 01221-15-3/4	248.1201.536	64	1/2	22	32	53.0	17.0	20.0	12.0	17.040
Für Zollrohre	Pour tubes pouces		For inch tubes							
SO 01221-6,35-1/8	248.1201.135	125	1/8	12	14	32.0	10.0	14.0	4.0	2.540
SO 01221-6,35-1/4	248.1201.140	125	1/8	12	17	34.0	11.0	15.0	4.0	3.280
SO 01221-6,35-3/8	248.1201.145	125	1/8	12	22	35.5	12.0	15.0	4.5	4.890
SO 01221-6,35-1/2	248.1201.150	125	1/4	14	27	38.0	14.0	16.0	6.4	8.340
SO 01221-9,52-1/4	248.1201.230	125	3/8	17	17	39.5	11.0	16.5	8.4	6.370
SO 01221-9,52-3/8	248.1201.235	125	3/8	17	22	40.5	12.0	16.5	8.5	8.010
SO 01221-9,52-1/2	248.1201.240	125	3/8	17	27	43.0	14.0	17.0	8.5	10.360
SO 01221-9,52-3/4	248.1201.244	125	3/8	17	32	46.0	17.0	17.0	8.0	13.140
SO 01221-12,7-3/8	248.1201.432	100	1/2	22	22	45.5	12.0	19.0	10.5	12.150
SO 01221-12,7-1/2	248.1201.434	100	1/2	22	27	48.0	14.0	19.5	12.5	13.940
SO 01221-12,7-3/4	248.1201.436	100	1/2	22	32	50.0	17.0	19.5	12.0	17.310

Umrechnung für "d" bei Zollrohren:

 6,35 = 1/4
 9,52 = 3/8
 12,7 = 1/2

Conversion de "d" pour tubes en pouces:

 6,35 = 1/4
 9,52 = 3/8
 12,7 = 1/2

Conversion for "d" for inch tubes:

 6,35 = 1/4
 9,52 = 3/8
 12,7 = 1/2

Verschraubung mit Einlötnippel

Union avec embout à braser

Adaptor union with soldering nipple

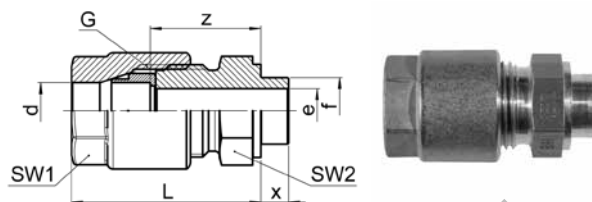
SO 01421

Type-d	Mat.-Nr.	bar	G	SW1	SW2	L	f	x	z	e	kg/100
Für metrische Rohre	Pour tubes métriques			For metric tubes							
SO 01421-4	248.1400.060	125	1/8	12	12	23.5	6.0	3.0	17.0	4.0	1.860
SO 01421-5	248.1400.080	125	1/8	12	12	24.0	6.0	3.0	17.0	4.0	1.900
SO 01421-6	248.1400.100	125	1/8	12	12	24.0	6.0	3.0	17.0	4.0	1.960
SO 01421-8	248.1400.140	125	1/4	14	14	27.0	9.0	4.0	19.0	6.0	3.640
SO 01421-10	248.1400.185	100	3/8	17	17	30.5	12.0	5.0	20.0	8.0	6.050
SO 01421-12	248.1400.200	100	1/2	19	22	35.0	14.0	5.0	23.5	10.0	11.060
SO 01421-14	248.1400.250	64	1/2	22	22	38.0	14.0	5.0	24.0	10.0	11.720
SO 01421-15	248.1400.270	64	1/2	22	22	38.0	14.0	5.0	24.0	10.0	11.410
Für Zollrohre	Pour tubes pouces			For inch tubes							
SO 01421-6,35	248.1400.120	125	1/8	12	12	24.0	6.0	3.0	17.0	4.0	1.930
SO 01421-9,52	248.1400.164	125	3/8	17	17	30.5	12.0	5.0	20.0	8.0	6.100
SO 01421-12,7	248.1400.216	100	1/2	22	22	36.0	14.0	5.0	24.0	11.2	11.690

Umrechnung für "d" bei Zollrohren:

6,35 = 1/4
 9,52 = 3/8
 12,7 = 1/2

Conversion de "d" pour tubes en pouces:

6,35 = 1/4
 9,52 = 3/8
 12,7 = 1/2

Conversion for "d" for inch tubes:

6,35 = 1/4
 9,52 = 3/8
 12,7 = 1/2

Nach dem Anlöten die von SERTO empfohlenen Schmierstellen mit dem Spezial-Schmieröl AC 850 nochmals schmieren.

Après le brasage, graissez les points de lubrification nécessaires, conformément aux recommandations de SERTO, avec l'huile de lubrification spéciale AC 850.

After soldering, grease the necessary lubrication points as recommended by SERTO with the special lubrication oil AC 850.

Gerade Schottverschraubung

Durchführungslänge max. 5 mm

Union double traversée de cloison

pour cloison max. 5 mm

Panel mount union

max. panel thickness 5 mm

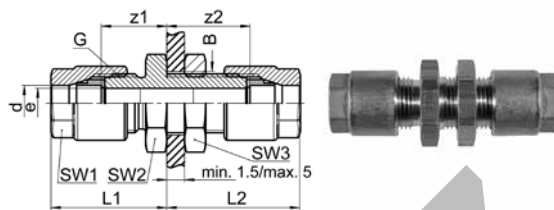

SO 01521

Type-d	Mat.-Nr.	bar	G	SW1	SW2	SW3	L1	L2	B	z1	z2	e	kg/100
Für metrische Rohre	Pour tubes métriques						For metric tubes						
SO 01521-4	248.1500.040	125	1/8	12	14	14	23.5	28.5	10.5	16.0	21.0	4.0	4.050
SO 01521-5	248.1500.050	125	1/8	12	14	14	24.0	29.0	10.5	16.0	21.0	4.0	4.130
SO 01521-6	248.1500.060	125	1/8	12	14	14	25.0	30.0	10.5	16.0	21.0	4.0	4.260
SO 01521-8	248.1500.080	125	1/4	14	19	19	27.5	33.5	14.0	17.0	23.0	6.5	8.260
SO 01521-10	248.1500.100	100	3/8	17	24	24	31.5	36.5	17.0	18.5	23.5	8.5	14.120
SO 01521-12	248.1500.120	100	1/2	19	30	30	36.5	41.5	21.5	22.0	27.0	12.0	26.500
SO 01521-15	248.1500.150	100	1/2	22	30	30	39.5	44.5	21.5	22.0	27.0	12.0	28.500

Für Zollrohre	Pour tubes pouces						For inch tubes						
SO 01521-6,35	248.1500.063	125	1/8	12	14	14	25.0	30.0	10.5	16.0	21.0	4.0	4.190
SO 01521-9,52	248.1500.095	100	3/8	17	24	24	31.5	36.5	17.0	18.5	23.5	8.5	14.200

Umrechnung für "d" bei Zollrohren:

6,35 = 1/4

9,52 = 3/8

Conversion de "d" pour tubes en pouces:

6,35 = 1/4

9,52 = 3/8

Conversion for "d" for inch tubes:

6,35 = 1/4

9,52 = 3/8

Sechskantmutter siehe SO 40006

Ecrou à six pans voir SO 40006

Hexagon nut see SO 40006

d=Rohrassens-ø
e=kleinste Bohrung
L=Mass in montiertem Zustand

d=ø extérieur du tube
e=ø-min. de passage
L=après montage

d=tube outside diameter
e=minimum bore
L=installed length

Gerade Schottverschraubung

Durchführungslänge max. 16 mm

Union double traversée de cloison

pour cloison max. 16 mm

Panel mount union

max. panel thickness 16 mm

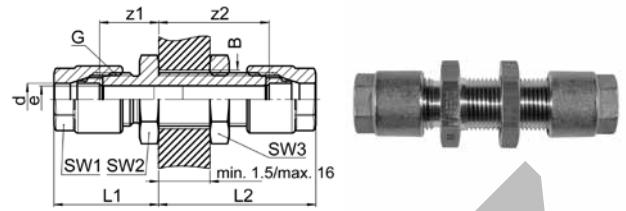

SO 01524

Type-d	Mat.-Nr.	bar	G	SW1	SW2	SW3	L1	L2	B	z1	z2	e	kg/100	
Für metrische Rohre	Pour tubes métriques						For metric tubes							
SO 01524-4	248.1540.040	125	1/8	12	14	14	23.5	39.5	10.5	16.0	32.0	4.0	4.520	
SO 01524-5	248.1540.050	125	1/8	12	14	14	24.0	40.0	10.5	16.0	32.0	4.0	4.610	
SO 01524-6	248.1540.060	125	1/8	12	14	14	25.0	41.0	10.5	16.0	32.0	4.0	4.730	
SO 01524-8	248.1540.080	125	1/4	14	19	19	27.5	44.5	14.0	17.0	34.0	6.5	8.990	
SO 01524-10	248.1540.100	100	3/8	17	24	24	31.5	47.5	17.0	18.5	34.5	8.5	15.240	
SO 01524-12	248.1540.120	100	1/2	19	30	30	36.5	52.5	21.5	22.0	38.0	12.0	25.700	
SO 01524-14	248.1540.140	64	1/2	22	30	30	40.0	56.0	21.5	22.5	38.5	12.0	27.620	
SO 01524-15	248.1540.150	64	1/2	22	30	30	40.0	56.0	21.5	22.0	38.5	12.0	27.000	
Für Zollrohre	Pour tubes pouces						For inch tubes							
SO 01524-6,35	248.1540.063	125	1/8	12	14	14	25.0	41.0	10.5	16.0	32.0	4.0	4.660	
SO 01524-9,52	248.1540.095	125	3/8	17	24	24	31.5	47.5	17.0	18.5	34.5	8.5	15.320	
SO 01524-12,7	248.1540.127	100	1/2	22	30	30	37.5	53.5	21.5	22.5	38.0	12.0	27.550	

Umrechnung für "d" bei Zollrohren:

6,35 = 1/4
9,52 = 3/8
12,7 = 1/2

Conversion de "d" pour tubes en pouces:

6,35 = 1/4
9,52 = 3/8
12,7 = 1/2

Conversion for "d" for inch tubes:

6,35 = 1/4
9,52 = 3/8
12,7 = 1/2

Sechskantmutter siehe SO 40006

Ecrou à six pans voir SO 40006

Hexagon nut see SO 40006

Gerade Schottverschraubung reduziert

Durchführungslänge max. 5 mm

Union double réduite traversée de cloison

pour cloison max. 5 mm

Panel mount reduction union

max. panel thickness 5 mm

SO 01528 RED

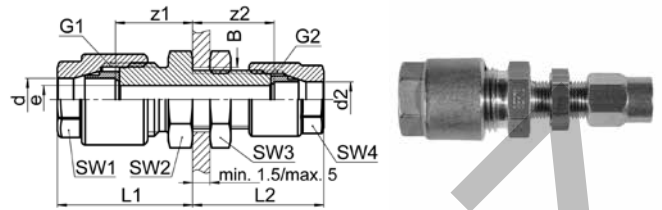

Type - d - d2	Mat.-Nr.	bar	G1	G2	SW1	SW2	SW3	SW4	L1	L2	B	z1	z2	e	kg/100	
Für metrische Rohre			Pour tubes métriques						For metric tubes							
SO 01528-6-4	248.1504.110	125	1/8	1/8	12	14	14	12	24.0	27.5	10.5	16.5	21.0	3.4	4.150	
SO 01528-8-6	248.1504.140	125	1/4	1/8	14	14	14	12	26.5	29.0	10.5	17.0	21.0	4.0	5.750	
SO 01528-10-6	248.1504.175	100	3/8	1/8	17	17	14	12	30.5	29.0	10.5	18.5	21.0	4.0	8.420	
SO 01528-10-8	248.1504.190	100	3/8	1/4	17	19	19	14	30.5	32.5	14.0	18.5	23.0	6.0	10.760	
SO 01528-12-10	248.1504.240	100	1/2	3/8	19	24	24	17	35.5	35.5	17.0	22.0	23.5	8.0	18.700	
SO 01528-14-10	248.1504.320	64	1/2	3/8	22	24	24	17	38.5	36.0	17.0	22.5	23.5	8.0	19.360	
SO 01528-14-12	248.1504.340	64	1/2	1/2	22	30	30	19	38.5	51.5	21.5	22.5	38.0	11.0	26.960	
SO 01528-15-10	248.1504.410	64	1/2	3/8	22	24	24	17	38.5	35.5	17.0	22.5	23.5	8.0	19.050	
SO 01528-15-12	248.1504.420	64	1/2	1/2	22	30	30	19	38.5	51.5	21.5	22.5	38.0	11.0	26.650	

Für Zollrohre			Pour tubes pouces						For inch tubes							
SO 01528-6,35-4	248.1504.123	125	1/8	1/8	12	14	14	12	24.0	27.5	10.5	16.5	21.0	3.4	4.120	
SO 01528-8-6,35	248.1504.141	125	1/4	1/8	14	14	14	12	26.5	29.0	10.5	17.0	21.0	4.0	5.710	
SO 01528-9,52-8	248.1504.162	100	3/8	1/4	17	19	19	14	30.5	32.5	14.0	18.5	23.0	6.0	10.800	
SO 01528-12-9,52	248.1504.236	100	1/2	3/8	19	24	24	17	35.5	35.5	17.0	22.0	23.5	8.0	18.740	
SO 01528-12,7-9,52	248.1504.270	100	1/2	3/8	22	24	24	17	36.5	35.5	17.0	22.0	23.5	8.0	19.370	
SO 01528-12,7-10	248.1504.272	100	1/2	3/8	22	24	24	17	36.5	35.5	17.0	22.0	23.5	8.0	19.330	

Umrechnung für "d" bei Zollrohren:

6,35 = 1/4

9,52 = 3/8

12,7 = 1/2

Conversion de "d" pour tubes en pouces:

6,35 = 1/4

9,52 = 3/8

12,7 = 1/2

Conversion for "d" for inch tubes:

6,35 = 1/4

9,52 = 3/8

12,7 = 1/2

Sechskantmutter siehe SO 40006

Ecrou à six pans voir SO 40006

Hexagon nut see SO 40006

Einstellnippel Adaptateur orientable mâle Adjustable male adaptor

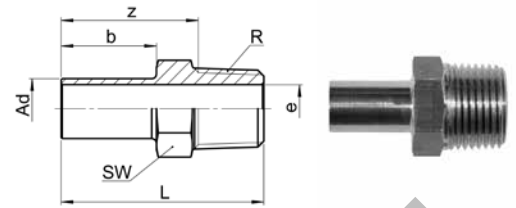

SO 41600

Type -Ad -R	Mat.-Nr.	bar	SW	L	b	z	e	kg/100
R=Rohrgewinde (kegelig)	R=Filetage-gaz BSP (conique)	R=BSP thread (tapered)						
SO 41600-A6-1/8	016.1601.100	200	12	26.0	13.0	19.5	4.0	1.000
SO 41600-A6-1/4	016.1601.110	200	14	31.0	13.0	21.5	4.0	1.950
SO 41600-A8-1/8	016.1601.160	100	12	28.0	14.0	21.5	6.0	1.200
SO 41600-A8-1/4	016.1601.170	100	14	32.0	14.0	22.5	6.0	1.800
SO 41600-A10-1/4	016.1601.270	80	14	34.0	16.0	24.5	8.0	1.650
SO 41600-A10-3/8	016.1601.280	80	17	34.0	16.0	24.0	8.0	2.900
SO 41600-A10-1/2	016.1601.285	80	22	39.0	16.0	27.5	8.0	5.570
SO 41600-A12-1/4	016.1601.380	60	14	36.0	18.0	26.5	9.0	1.750
SO 41600-A12-3/8	016.1601.390	60	17	36.0	18.0	26.0	9.0	3.000
SO 41600-A12-1/2	016.1601.400	60	22	41.0	18.0	29.5	9.0	5.670
SO 41600-A14-1/2	016.1601.504	40	22	44.0	21.0	32.5	11.0	5.650
SO 41600-A15-3/8	016.1601.532	40	17	39.0	21.0	29.0	10.5	3.200

3

Anwendungsbeispiele:

Exemples d'utilisation:

Sample combinations:

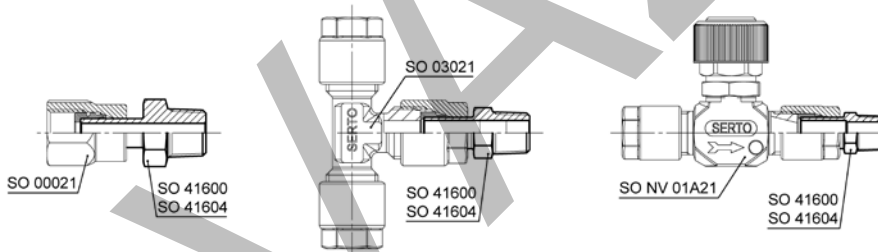

Mögliche Kombinationen:

- mit Armaturenanschluss zu einstellbaren Einschraubverschraubungen
- mit Verschraubungen/Ventilen zu einstellbaren Verschraubungen/Ventilen

Hinweis: Nur mit Einstellnippel SO 41604 ist eine radiale Demontage möglich.

Combinaisons possibles:

- avec écrou de raccordement ça donne des unions mâle orientables
- avec raccords/vannes ça donne des raccords/vannes orientables

Remarque: Un démontage radial n'est possible qu'avec l'union orientable mâle SO 41604.

Possible combinations:

- with nut connection to adjustable male adaptor unions
- with unions/valves to adjustable unions/valves

Note: Radial dismantling is only possible with adjustable male adaptor SO 41604.

Einstellnippel

radial demontierbar

Adaptateur orientable mâle

démontable radialement

Adjustable male adaptor

radial dismantling

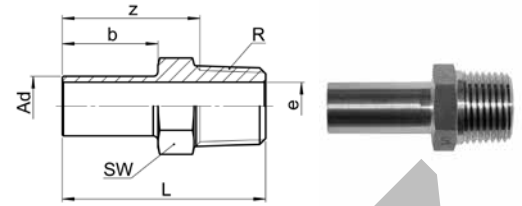

SO 41604

Type -Ad-R	Mat.-Nr.	bar	SW	L	b	z	e	kg/100
R=Rohrgewinde (kegelig)	R=Filetage-gaz BSP (conique)					R=BSP thread (tapered)		
SO 41604-A15-1/2	016.1611.534	40	22	53.0	30.0	40.0	12.0	5.760
SO 41604-A15-3/4	016.1611.536	40	27	55.0	30.0	40.0	12.0	7.800
SO 41604-A22-1	016.1611.770	25	36	65.0	36.0	48.5	18.0	16.540
SO 41604-A28-1 1/4	016.1611.860	16	46	75.5	41.5	56.5	23.0	33.860

Anwendungsbeispiele:

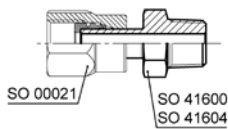

Mögliche Kombinationen:

- mit Armaturenanschluss zu einstellbaren Einschraubverschraubungen
- mit Verschraubungen/Ventilen zu einstellbaren Verschraubungen/Ventilen

Hinweis: Nur mit Einstellnippel SO 41604 ist eine radiale Demontage möglich.

Exemples d'utilisation:

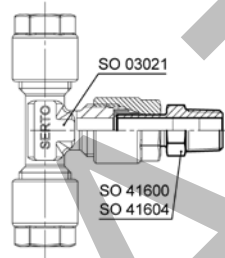

Combinaisons possibles:

- avec écrou de raccordement ça donne des unions mâle orientables
- avec raccords/vannes ça donne des raccords/vannes orientables

Remarque: Un démontage radial n'est possible qu'avec l'union orientable mâle SO 41604.

Sample combinations:

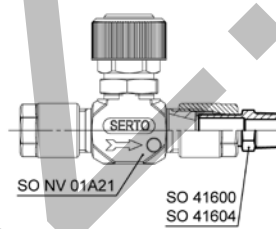

Possible combinations:

- with nut connection to adjustable male adaptor unions
- with unions/valves to adjustable unions/valves

Note: Radial dismantling is only possible with adjustable male adaptor SO 41604.

Winkelverschraubung

Coude

Elbow union

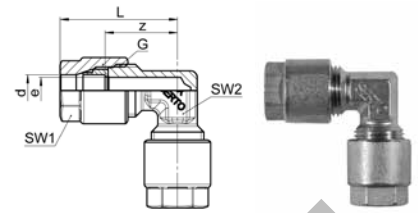

SO 02021

Type -d	Mat.-Nr.	bar	G	SW1	SW2	L	z	e	kg/100
Für metrische Rohre	Pour tubes métriques			For metric tubes					
SO 02021-4	248.2000.040	125	1/8	12	10	26.5	20.0	4.0	3.440
SO 02021-5	248.2000.050	125	1/8	12	10	27.0	20.0	4.0	3.530
SO 02021-6	248.2000.060	125	1/8	12	10	28.0	20.0	4.0	3.650
SO 02021-8	248.2000.080	125	1/4	14	11	31.5	22.0	6.0	6.630
SO 02021-10	248.2000.100	100	3/8	17	14	35.0	23.0	8.0	10.470
SO 02021-12	248.2000.120	100	1/2	19	17	39.5	26.0	10.0	18.450
SO 02021-14	248.2000.140	64	1/2	22	19	45.5	29.5	12.0	20.420
SO 02021-15	248.2000.150	64	1/2	22	19	45.5	29.5	12.0	19.800
Für Zollrohre	Pour tubes pouces			For inch tubes					
SO 02021-6,35	248.2000.063	125	1/8	12	10	28.0	20.0	4.0	3.580
SO 02021-9,52	248.2000.095	100	3/8	17	14	35.0	23.0	8.0	10.550
SO 02021-12,7	248.2000.127	100	1/2	22	17	39.5	26.0	10.0	19.700

Umrechnung für "d" bei Zollrohren:

 6,35 = 1/4
 9,52 = 3/8
 12,7 = 1/2

Conversion de "d" pour tubes en pouces:

 6,35 = 1/4
 9,52 = 3/8
 12,7 = 1/2

Conversion for "d" for inch tubes:

 6,35 = 1/4
 9,52 = 3/8
 12,7 = 1/2

Winkelverschraubung

mit Übergangsnippel SO 00040

Coude

avec adaptateur mâle SO 00040

Elbow union

with male adaptor SO 00040

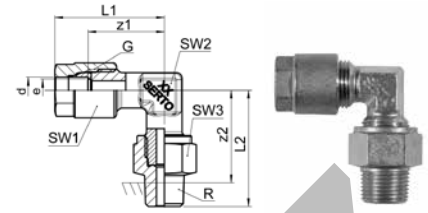

SO 02121

Type -d -R	Mat.-Nr.	bar	G	SW1	SW2	SW3	L1	L2	z1	z2	e	kg/100
R=Rohrgewinde (kegelig)				R=Filetage-gaz BSP (conique)			R=BSP thread (tapered)					
SO 02121-6-1/8	248.2101.100	125	1/8	12	10	14	28.0	29.5	20.0	24.5	4.0	3.930
SO 02121-6-1/4	248.2101.110	125	1/8	12	10	14	28.0	33.5	20.0	25.5	4.0	4.710
SO 02121-6-3/8	248.2101.120	125	1/8	12	10	17	28.0	35.5	20.0	27.5	4.0	6.530
SO 02121-6-1/2	248.2101.125	125	1/4	14	11	22	31.5	41.0	22.0	31.0	4.5	10.510
SO 02121-8-1/8	248.2101.160	125	1/4	14	11	17	31.5	33.0	22.0	29.0	5.0	6.480
SO 02121-8-1/4	248.2101.170	125	1/4	14	11	17	31.5	37.0	22.0	29.0	6.0	4.650
SO 02121-8-3/8	248.2101.180	125	1/4	14	11	17	31.5	37.0	22.0	31.0	6.0	7.900
SO 02121-8-1/2	248.2101.185	125	1/4	14	11	22	31.5	41.0	22.0	31.5	6.0	10.510
SO 02121-10-1/4	248.2101.270	100	3/8	17	14	22	35.0	39.5	23.0	31.5	8.0	10.860
SO 02121-10-3/8	248.2101.280	100	3/8	17	14	22	35.0	39.5	23.0	31.5	8.0	11.720
SO 02121-10-1/2	248.2101.285	100	3/8	17	14	22	35.0	41.5	23.0	34.5	8.0	12.330
SO 02121-12-1/4	248.2101.380	100	1/2	19	17	27	39.5	42.5	26.0	34.5	7.0	18.540
SO 02121-12-3/8	248.2101.390	100	1/2	19	17	27	39.5	42.5	26.0	34.5	10.0	18.610
SO 02121-12-1/2	248.2101.400	100	1/2	19	17	27	39.5	44.5	26.0	34.5	11.0	19.490
SO 02121-14-3/8	248.2101.502	64	1/2	22	19	27	45.5	45.5	29.5	37.5	10.0	19.920

Winkelverschraubung

mit Übergangsnippel SO 00040 NPT

Coude

avec adaptateur mâle SO 00040 NPT

Elbow union

with male adaptor SO 00040 NPT

SO 02121 NPT

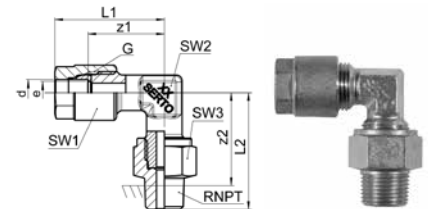

Type -d -RNPT	Mat.-Nr.	bar	G	SW1	SW2	SW3	L1	L2	z1	z2	e	kg/100
RNPT=NPT Gewinde				RNPT=Filetage NPT			RNPT=NPT thread					
SO 02121-6-1/4 NPT	248.2102.110	125	1/8	12	10	14	28.0	35.5	20.0	25.5	4.0	4.600
SO 02121-8-1/8 NPT	248.2102.160	125	1/4	14	11	17	31.5	35.0	22.0	28.0	5.0	6.470

Montagehinweis: Nippel ist handfest montiert. Bei Endmontage mit 1/4 Umdrehung anziehen.

Wir empfehlen eine zusätzliche Schmierung auf der Planfläche.

Note d'installation: L'adaptateur femelle-mâle est monté serré à la main. Pour le montage final, serrer avec 1/4 de tour.

Nous recommandons une lubrification supplémentaire sur la surface plane.

Assembly information: Male adaptor is mounted finger-tight. For final assembly, tighten with 1/4 turn.

We recommend additional lubrication on the plane surface.

Winkelverschraubung

mit Übergangsnippel SO 00040 METR

Coude

avec adaptateur mâle SO 00040 METR

Elbow union

with male adaptor SO 00040 METR

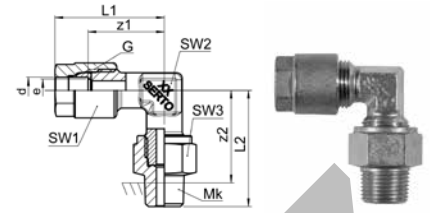

SO 02121 METR

Type -d -Mk	Mat.-Nr.	bar	G	SW1	SW2	SW3	L1	L2	z1	z2	e	kg/100
Mk=metrisches Gewinde (kegelig)	Mk=Filetage métrique (conique)	Mk=metric thread (tapered)										
SO 02121-6-M10x1	248.2103.180	125	1/8	12	10	14	28.0	29.5	20.0	24.5	5.0	3.890
SO 02121-8-M12x1,5	248.2103.240	125	1/4	14	11	17	31.5	37.0	22.0	29.0	6.0	6.870
SO 02121-10-M14x1,5	248.2103.280	100	3/8	17	14	22	35.0	39.5	23.0	31.5	8.0	11.010
SO 02121-12-M16x1,5	248.2103.330	100	1/2	19	17	27	39.5	42.5	26.0	34.5	10.0	18.310

Montagehinweis: Nippel ist handfest montiert. Bei Endmontage mit 1/4 Umdrehung anziehen.
Wir empfehlen eine zusätzliche Schmierung auf der Planfläche.

Note d'installation: L'adaptateur femelle-mâle est monté serré à la main. Pour le montage final, serrer avec 1/4 de tour.
Nous recommandons une lubrification supplémentaire sur la surface plane.

Assembly information: Male adaptor is mounted finger-tight. For final assembly, tighten with 1/4 turn.
We recommend additional lubrication on the plane surface.

KONVAM

d=Rohrussen-ø
e=kleinste Bohrung
L=Mass in montiertem Zustand

d=ø extérieur du tube
e=ø-min. de passage
L=après montage

d=tube outside diameter
e=minimum bore
L=installed length

Winkelverschraubung

mit Übergangsmuffe SO 00030

Coude

avec adaptateur femelle SO 00030

Elbow union

with female adaptor SO 00030

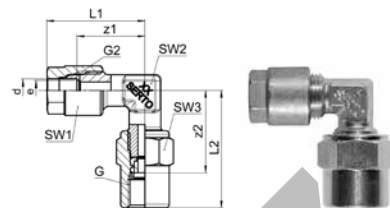

SO 02221

Type -d-G	Mat.-Nr.	bar	G2	SW1	SW2	SW3	L1	L2	z1	z2	e	kg/100
G=Rohrgewinde (zylindrisch)			G=Filetage-gaz BSP (cylindrique)									
			G=BSP thread (parallel)									
SO 02221-6-1/8	248.2201.100	125	1/8	12	10	14	28.0	33.5	20.0	23.5	4.0	4.510
SO 02221-6-1/4	248.2201.110	125	1/8	12	10	19	28.0	35.0	20.0	24.0	4.0	6.760
SO 02221-6-3/8	248.2201.120	125	1/8	12	10	22	28.0	36.5	20.0	24.5	4.0	8.280
SO 02221-8-1/8	248.2201.160	125	1/4	14	11	17	31.5	35.5	22.0	25.5	6.0	7.030
SO 02221-8-1/4	248.2201.170	125	1/4	14	11	19	31.5	37.0	22.0	26.0	6.0	8.360
SO 02221-8-3/8	248.2201.180	125	1/4	14	11	22	31.5	38.5	22.0	26.5	6.0	10.010
SO 02221-10-1/4	248.2201.270	100	3/8	17	14	22	35.0	38.0	23.0	27.0	8.0	11.770
SO 02221-10-3/8	248.2201.280	100	3/8	17	14	24	35.0	39.5	23.0	27.5	8.0	13.520
SO 02221-10-1/2	248.2201.285	100	3/8	17	14	30	35.0	42.0	23.0	28.0	8.0	19.150
SO 02221-12-1/4	248.2201.380	100	1/2	19	17	27	39.5	41.0	26.0	26.0	8.5	18.970
SO 02221-12-3/8	248.2201.390	100	1/2	19	17	27	39.5	42.5	26.0	30.5	10.0	20.470
SO 02221-15-1/2	248.2201.534	64	1/2	22	19	30	45.5	48.0	29.5	34.0	12.0	25.100
SO 02221-15-3/4	248.2201.536	64	1/2	22	19	32	45.5	51.5	29.5	34.5	12.0	26.560

Montagehinweis: Muffe ist handfest montiert. Bei Endmontage mit 1/4 Umdrehung anziehen.

Wir empfehlen eine zusätzliche Schmierung auf der Planfläche.

Note d'installation: L'adaptateur femelle est monté serré à la main. Pour le montage final, serrer avec 1/4 de tour.

Nous recommandons une lubrification supplémentaire sur la surface plane.

Assembly information: Female adaptor is mounted finger-tight. For final assembly, tighten with 1/4 turn.

We recommend additional lubrication on the plane surface.

Anschlusswinkel

mit Wandflansch

Coude femelle

avec applique de fixation

Female adaptor elbow union

with wall flange

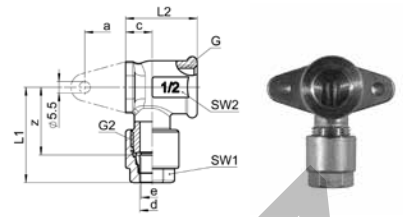

SO 02321

Type -d-G	Mat.-Nr.	bar	G2	SW1	SW2	L1	L2	a	c	z	e	kg/100
Für metrische Rohre	Pour tubes métriques					For metric tubes						
G=Rohrgewinde (zylindrisch)	G=Filetage-gaz BSP (cylindrique)					G=BSP thread (parallel)						
SO 02321-8-3/8	248.2301.180	125	1/4	17	22	36.5	27.0	40.0	11.0	27.0	6.0	10.790
SO 02321-10-3/8	248.2301.280	100	3/8	17	22	39.0	27.0	40.0	11.0	27.0	8.0	12.390
SO 02321-10-1/2	248.2301.285	100	3/8	17	27	45.0	35.0	40.0	13.0	33.0	8.0	17.320
SO 02321-12-3/8	248.2301.390	100	1/2	19	22	44.5	29.0	40.0	13.0	31.0	10.0	15.900
SO 02321-12-1/2	248.2301.400	100	1/2	19	27	46.5	25.0	40.0	13.0	33.0	11.0	19.140
SO 02321-12-3/4	248.2301.405	100	1/2	19	32	51.5	41.5	46.0	17.5	38.0	11.0	26.130
SO 02321-14-3/8	248.2301.502	64	1/2	22	22	47.5	29.0	40.0	13.0	31.5	10.0	16.560
SO 02321-14-1/2	248.2301.504	64	1/2	22	27	49.5	35.0	40.0	13.0	33.5	12.0	19.800
SO 02321-14-3/4	248.2301.506	64	1/2	22	32	54.5	41.5	46.0	17.5	38.5	12.0	26.790
SO 02321-15-3/8	248.2301.532	64	1/2	22	22	47.5	29.0	40.0	13.0	31.5	10.0	16.250
SO 02321-15-1/2	248.2301.534	64	1/2	22	27	49.5	25.0	40.0	13.0	33.5	12.0	19.490
SO 02321-15-3/4	248.2301.536	64	1/2	22	32	54.5	41.5	46.0	17.5	38.5	12.0	26.480
Für Zollrohre	Pour tubes pouces					For inch tubes						
SO 02321-9,52-3/8	248.2301.235	100	3/8	17	22	39.0	27.0	40.0	11.0	27.0	8.0	12.430
SO 02321-9,52-1/2	248.2301.240	100	3/8	17	22	45.0	35.0	40.0	13.0	33.0	8.0	17.360
SO 02321-12,7-3/8	248.2301.432	100	1/2	22	19	45.5	29.0	40.0	13.0	31.0	10.0	16.520
SO 02321-12,7-1/2	248.2301.434	100	1/2	22	19	45.5	25.0	40.0	13.0	33.0	11.0	19.770
SO 02321-12,7-3/4	248.2301.436	100	1/2	22	32	52.5	41.5	46.0	17.5	38.0	11.0	26.760

Umrechnung für "d" bei Zollrohren:

9,52 = 3/8
12,7 = 1/2

Conversion de "d" pour tubes en pouces:

9,52 = 3/8
12,7 = 1/2

Conversion for "d" for inch tubes:

9,52 = 3/8
12,7 = 1/2

d=Rohrassen-ø
e=kleinste Bohrung
L=Mass in montiertem Zustand
a=Lochabstand

d=ø extérieur du tube
e=ø-min. de passage
L=après montage
a=distance des trous

d=tube outside diameter
e=minimum bore
L=installed length
a=center hole distance

Winkel-Einschraubverschraubung

Coude mâle

Male adaptor elbow union

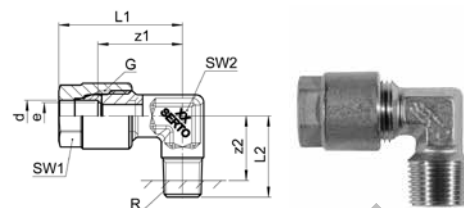

SO 02421

Type -d-R	Mat.-Nr.	bar	G	SW1	SW2	L1	L2	z1	z2	e	kg/100
Für metrische Rohre	Pour tubes métriques		For metric tubes								
R=Rohrgewinde (kegelig)	R=Filetage-gaz BSP (conique)		R=BSP thread (tapered)								
SO 02421-4-1/8	248.2401.060	125	1/8	12	10	26.5	19.5	20.0	13.5	3.4	2.620
SO 02421-5-1/8	248.2401.082	125	1/8	12	10	27.0	19.5	20.0	13.5	4.0	2.660
SO 02421-6-1/8	248.2401.100	125	1/8	12	10	28.0	19.5	20.0	13.5	4.0	2.720
SO 02421-6-1/4	248.2401.110	125	1/8	12	11	30.0	25.0	22.0	15.0	4.0	3.870
SO 02421-8-1/8	248.2401.160	125	1/4	14	11	31.5	21.0	22.0	14.5	5.0	4.430
SO 02421-8-1/4	248.2401.170	125	1/4	14	11	31.5	25.0	22.0	15.0	6.0	4.990
SO 02421-8-3/8	248.2401.180	125	1/4	14	14	32.5	25.0	23.0	16.0	6.0	6.100
SO 02421-10-1/4	248.2401.270	100	3/8	17	14	35.0	25.0	23.0	15.0	8.0	6.740
SO 02421-10-3/8	248.2401.280	100	3/8	17	14	35.0	25.0	23.0	16.0	8.0	7.530
SO 02421-10-1/2	248.2401.285	100	3/8	17	19	41.0	31.5	29.0	19.0	8.0	11.660
SO 02421-12-1/4	248.2401.380	100	1/2	19	17	39.0	25.5	26.0	16.0	7.0	11.670
SO 02421-12-3/8	248.2401.390	100	1/2	19	17	39.0	25.0	26.0	16.0	10.0	11.570
SO 02421-12-1/2	248.2401.400	100	1/2	19	19	42.0	31.5	29.0	19.0	12.0	13.890
SO 02421-14-3/8	248.2401.502	64	1/2	22	17	42.5	25.0	26.5	16.0	10.0	12.230
SO 02421-14-1/2	248.2401.504	64	1/2	22	19	42.5	31.5	29.5	19.0	12.0	14.550
SO 02421-14-3/4	248.2401.506	64	1/2	22	22	47.5	34.0	31.5	20.0	12.0	19.570
SO 02421-15-3/8	248.2401.532	64	1/2	22	17	42.5	25.0	26.5	16.0	10.0	11.920
SO 02421-15-1/2	248.2401.534	64	1/2	22	19	45.5	31.5	29.5	19.0	12.0	14.240
SO 02421-15-3/4	248.2401.536	64	1/2	22	22	47.5	34.0	31.5	20.0	12.0	19.260

Für Zollrohre

Pour tubes pouces

For inch tubes

SO 02421-6,35-1/8	248.2401.135	125	1/8	12	10	28.0	19.5	20.0	13.5	4.0	2.690
SO 02421-6,35-1/4	248.2401.140	125	1/8	12	11	30.0	25.0	22.0	15.0	4.0	3.830
SO 02421-9,52-1/4	248.2401.230	100	3/8	17	14	35.0	25.0	23.0	15.0	8.0	6.780
SO 02421-9,52-3/8	248.2401.235	100	3/8	17	14	35.0	25.0	23.0	16.0	8.0	7.570
SO 02421-9,52-1/2	248.2401.240	100	3/8	17	19	41.0	31.5	29.0	19.0	8.0	11.710
SO 02421-12,7-1/4	248.2401.430	100	1/2	19	17	39.0	25.5	26.0	16.0	7.0	12.300
SO 02421-12,7-3/8	248.2401.432	100	1/2	19	17	39.0	25.0	26.0	16.0	10.0	12.200
SO 02421-12,7-1/2	248.2401.434	100	1/2	19	19	42.0	31.5	29.0	19.0	11.0	14.510

Umrechnung für "d" bei Zollrohren:

6,35 = 1/4
 9,52 = 3/8
 12,7 = 1/2

Conversion de "d" pour tubes en pouces:

6,35 = 1/4
 9,52 = 3/8
 12,7 = 1/2

Conversion for "d" for inch tubes:

6,35 = 1/4
 9,52 = 3/8
 12,7 = 1/2

Winkel-Einschraubverschraubung NPT

Coude mâle NPT

Male adaptor elbow union NPT

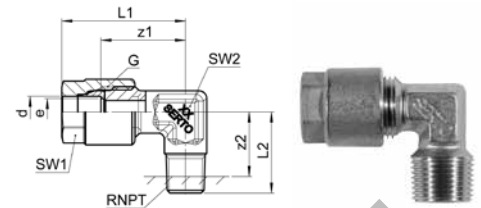

SO 02421 NPT

Type -d -RNPT	Mat.-Nr.	bar	G	SW1	SW2	L1	L2	z1	z2	e	kg/100
Für metrische Rohre	Pour tubes métriques		For metric tubes								
RNPT=NPT Gewinde	RNPT=Filetage NPT		RNPT=NPT thread								
SO 02421-4-1/8 NPT	248.2402.060	125	1/8	12	10	26.5	19.5	20.0	13.0	3.4	2.680
SO 02421-4-1/4 NPT	248.2402.065	125	1/8	12	11	30.0	25.0	22.0	15.0	3.4	3.730
SO 02421-5-1/8 NPT	248.2402.082	125	1/8	12	10	27.0	19.5	20.0	13.0	4.0	2.720
SO 02421-6-1/8 NPT	248.2402.100	125	1/8	12	10	28.0	19.5	20.0	13.0	4.0	2.780
SO 02421-6-1/4 NPT	248.2402.110	125	1/8	12	11	30.0	25.0	22.0	15.0	4.0	3.830
SO 02421-6-3/8 NPT	248.2402.120	125	1/8	12	11	30.0	25.0	22.0	16.0	4.0	4.980
SO 02421-8-1/8 NPT	248.2402.160	125	1/4	14	11	31.5	21.0	22.0	14.0	5.0	4.420
SO 02421-8-1/4 NPT	248.2402.170	125	1/4	14	11	31.5	25.0	22.0	15.0	6.0	4.990
SO 02421-8-3/8 NPT	248.2402.180	125	1/4	14	11	31.5	25.0	23.0	16.0	6.0	6.240
SO 02421-10-1/4 NPT	248.2402.270	100	3/8	17	14	35.0	25.0	23.0	15.0	8.0	6.840
SO 02421-10-3/8 NPT	248.2402.280	100	3/8	17	14	35.0	25.0	23.0	16.0	8.0	7.600
SO 02421-10-1/2 NPT	248.2402.285	100	3/8	17	19	41.0	31.5	29.0	18.0	8.0	11.620
SO 02421-12-1/4 NPT	248.2402.380	100	1/2	19	17	39.0	25.5	26.0	15.0	7.0	11.650
SO 02421-12-3/8 NPT	248.2402.390	100	1/2	19	17	39.0	25.0	26.0	16.0	10.0	11.520
SO 02421-12-1/2 NPT	248.2402.400	100	1/2	19	19	42.0	31.5	29.0	18.0	12.0	13.870
SO 02421-14-3/8 NPT	248.2402.502	64	1/2	22	17	42.5	25.0	26.5	16.0	10.0	12.180
SO 02421-14-1/2 NPT	248.2402.504	64	1/2	22	19	45.5	31.5	29.5	18.0	12.0	14.530
SO 02421-15-3/8 NPT	248.2402.532	64	1/2	22	17	42.5	25.0	26.5	16.0	10.0	11.870
SO 02421-15-1/2 NPT	248.2402.534	64	1/2	22	19	45.5	31.5	29.5	18.0	12.0	14.220

Für Zollrohre

Pour tubes pouces

For inch tubes

SO 02421-6,35-1/8 NPT	248.2402.135	125	1/8	12	10	28.0	19.5	20.0	13.0	4.0	2.750
SO 02421-6,35-1/4 NPT	248.2402.140	125	1/8	12	11	30.0	25.0	22.0	15.0	4.0	3.800
SO 02421-9,52-1/4 NPT	248.2402.230	125	3/8	17	14	35.0	25.0	23.0	15.0	8.0	6.880
SO 02421-9,52-3/8 NPT	248.2402.235	125	3/8	17	14	35.0	25.0	23.0	16.0	8.0	7.640
SO 02421-12,7-3/8 NPT	248.2402.432	100	1/2	22	17	39.0	25.0	26.0	16.0	10.0	12.140
SO 02421-12,7-1/2 NPT	248.2402.434	100	1/2	22	19	42.0	31.5	29.0	18.0	11.0	14.490

Umrechnung für "d" bei Zollrohren:

6,35 = 1/4

9,52 = 3/8

12,7 = 1/2

Conversion de "d" pour tubes en pouces:

6,35 = 1/4

9,52 = 3/8

12,7 = 1/2

Conversion for "d" for inch tubes:

6,35 = 1/4

9,52 = 3/8

12,7 = 1/2

Winkel-Aufschraubverschraubung
Coude femelle
Female adaptor elbow union

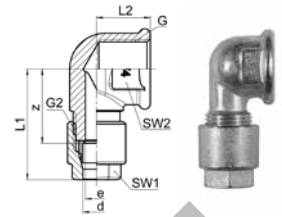

SO 02521

Type -d-G	Mat.-Nr.	bar	G2	SW1	SW2	L1	L2	z	e	kg/100
Für metrische Rohre	Pour tubes métriques			For metric tubes						
G=Rohrgewinde (zylindrisch)	G=Filetage-gaz BSP (cylindrique)			G=BSP thread (parallel)						
SO 02521-4-1/8	248.2501.060	125	1/8	12	14	28.5	11.5	22.0	3.4	2.710
SO 02521-5-1/8	248.2501.082	125	1/8	12	14	29.0	11.5	22.0	4.0	2.750
SO 02521-6-1/8	248.2501.100	125	1/8	12	14	30.0	11.5	22.0	4.0	2.820
SO 02521-6-1/4	248.2501.110	125	1/4	14	19	34.0	13.5	25.0	4.5	5.260
SO 02521-8-1/4	248.2501.170	125	1/4	14	19	34.5	13.5	25.0	6.0	5.260
SO 02521-8-3/8	248.2501.180	125	3/8	17	22	38.0	16.0	27.0	8.0	8.190
SO 02521-10-3/8	248.2501.280	100	3/8	17	22	39.0	16.0	27.0	8.0	8.090
SO 02521-10-1/2	248.2501.285	100	3/8	17	27	45.0	22.0	33.0	8.0	13.870
SO 02521-12-3/8	248.2501.390	100	1/2	19	22	43.0	18.0	29.0	10.0	13.190
SO 02521-12-1/2	248.2501.400	100	1/2	19	27	46.5	22.0	33.0	11.0	15.390
SO 02521-12-3/4	248.2501.405	100	1/2	19	32	46.5	24.0	33.0	11.0	19.450
SO 02521-14-3/8	248.2501.502	64	1/2	22	22	45.5	18.0	29.5	10.0	13.850
SO 02521-14-1/2	248.2501.504	64	1/2	22	27	49.5	22.0	33.5	12.0	16.050
SO 02521-14-3/4	248.2501.506	64	1/2	22	32	49.5	24.0	33.5	12.0	20.110
SO 02521-15-3/8	248.2501.532	64	1/2	22	22	45.5	18.0	29.5	10.0	13.540
SO 02521-15-1/2	248.2501.534	64	1/2	22	27	49.5	22.0	33.5	12.0	15.740
SO 02521-15-3/4	248.2501.536	64	1/2	22	32	49.5	24.0	33.5	12.0	19.800
Für Zollrohre	Pour tubes pouces			For inch tubes						
SO 02521-6,35-1/8	248.2501.135	125	1/8	12	14	30.0	11.5	22.0	4.0	2.780
SO 02521-6,35-1/4	248.2501.140	125	1/4	14	19	39.0	11.5	25.0	4.5	5.190
SO 02521-9,52-3/8	248.2501.235	100	3/8	17	22	39.0	16.0	27.0	8.0	8.140
SO 02521-9,52-1/2	248.2501.240	100	3/8	17	27	45.0	22.0	33.0	8.0	13.910
SO 02521-12,7-3/8	248.2501.432	100	1/2	22	22	43.0	18.0	29.0	10.0	13.810
SO 02521-12,7-1/2	248.2501.434	100	1/2	22	27	46.5	22.0	33.0	10.0	16.010
SO 02521-12,7-3/4	248.2501.436	100	1/2	22	32	47.5	24.0	33.0	10.0	20.080

Umrechnung für "d" bei Zollrohren:

- 6,35 = 1/4
- 9,52 = 3/8
- 12,7 = 1/2

Conversion de "d" pour tubes en pouces:

- 6,35 = 1/4
- 9,52 = 3/8
- 12,7 = 1/2

Conversion for "d" for inch tubes:

- 6,35 = 1/4
- 9,52 = 3/8
- 12,7 = 1/2

d=Rohrassens-ø
 e=kleinste Bohrung
 L=Mass in montiertem Zustand

d=ø extérieur du tube
 e=ø-min. de passage
 L=après montage

d=tube outside diameter
 e=minimum bore
 L=installed length

Einstellbare Winkelverschraubung

Coude orientable

Adjustable elbow union

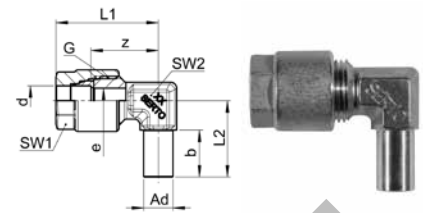

SO 02621

Type -d -Ad	Mat.-Nr.	bar	G	SW1	SW2	L1	L2	b	z	e	kg/100
SO 02621-6-A6	248.2600.060	125	1/8	12	10	28.0	19.0	13.0	20.0	4.0	2.320
SO 02621-8-A8	248.2600.080	125	1/4	14	11	31.5	22.0	14.0	22.0	6.0	4.040
SO 02621-10-A10	248.2600.100	100	3/8	17	14	35.5	26.0	16.0	23.0	8.0	6.460
SO 02621-12-A12	248.2600.120	100	1/2	19	19	42.0	31.0	18.0	29.0	9.0	13.530
SO 02621-14-A14	248.2600.140	64	1/2	22	19	45.5	31.0	21.0	29.5	11.0	12.920
SO 02621-15-A15	248.2600.150	64	1/2	22	19	45.5	31.0	21.0	29.5	12.0	12.310

Anwendungsbeispiele:

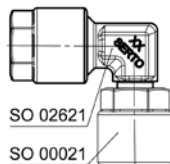

Mögliche Kombinationen:

- mit Armaturenanschluss zu einstellbaren Winkelverschraubungen
- mit Verschraubungen zu einstellbaren Verschraubungen
- mit Einschraubverschraubungen zu einstellbaren Einschraubwinkeln. Gegenüber dem Einschraubwinkel lässt sich diese Kombination einfacher einstellen, da Einschrauben und Ausrichten getrennt voneinander vorgenommen werden.

Exemples d'utilisation:

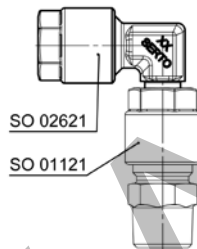

Combinaisons possibles:

- avec écrou de raccordement ça donne des raccords coudé orientables
- avec raccords ça donne des raccords orientables
- avec une union mâle ça donne un coude fileté orientable. Par rapport au coude orientable, cette combinaison est facile à régler, puisque le vissage et l'alignement sont réalisés séparément l'un de l'autre.

Sample combinations:

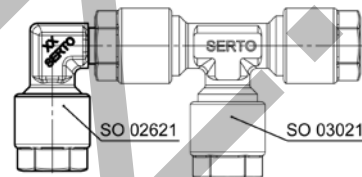

Possible combinations:

- with a nut connection to adjustable elbow unions
- with a union to adjustable unions
- with a male adaptor union to adjustable male adaptor elbow unions. This combination is simpler to produce, as screwing in and alignment are carried out separately.

Winkel-Schottverschraubung

Durchführungslänge max. 5 mm

Coude traversée de cloison

pour cloison max. 5 mm

Panel mount elbow union

max. panel thickness 5 mm

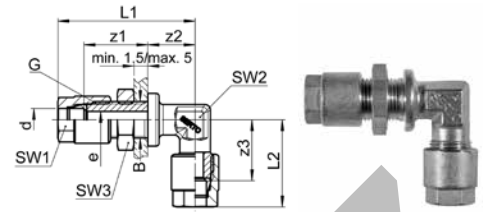

SO 02721

Type -d	Mat.-Nr.	bar	G	SW1	SW2	SW3	L1	L2	B	z1	z2	z3	e	kg/100	
Für metrische Rohre			Pour tubes métriques					For metric tubes							
SO 02721-4	248.2700.040	125	1/8	12	10	14	41.0	26.5	10.5	21.0	14.0	20.0	3.4	4.750	
SO 02721-5	248.2700.050	125	1/8	12	10	14	42.0	27.0	10.5	21.0	14.0	20.0	4.0	4.840	
SO 02721-6	248.2700.060	125	1/8	12	10	14	43.0	28.0	10.5	21.0	14.0	20.0	4.0	4.960	
SO 02721-8	248.2700.080	125	1/4	14	11	19	49.5	31.5	14.0	23.0	17.0	22.0	6.0	9.350	
SO 02721-10	248.2700.100	100	3/8	17	17	24	53.5	38.0	17.0	23.5	18.0	26.0	8.0	16.060	
SO 02721-12	248.2700.120	100	1/2	19	19	30	61.0	42.5	21.5	27.0	20.0	29.0	11.0	25.680	
SO 02721-14	248.2700.140	64	1/2	22	19	30	63.5	45.5	21.5	27.5	20.0	29.5	12.0	27.000	
SO 02721-15	248.2700.150	64	1/2	22	19	30	63.5	45.5	21.5	27.5	20.0	29.5	12.0	26.390	
Für Zollrohre			Pour tubes pouces					For inch tubes							
SO 02721-6,35	248.2700.063	125	1/8	12	10	14	43.0	28.0	10.5	21.0	14.0	20.0	4.0	4.890	
SO 02721-9,52	248.2700.095	100	3/8	17	17	24	53.5	38.0	17.0	23.5	18.0	26.0	8.0	16.140	
SO 02721-12,7	248.2700.127	100	1/2	22	19	30	61.5	43.5	21.5	27.0	20.0	29.0	11.0	26.940	

Umrechnung für "d" bei Zollrohren:

6,35 = 1/4

9,52 = 3/8

12,7 = 1/2

Conversion de "d" pour tubes en pouces:

6,35 = 1/4

9,52 = 3/8

12,7 = 1/2

Conversion for "d" for inch tubes:

6,35 = 1/4

9,52 = 3/8

12,7 = 1/2

Sechskantmutter siehe SO 40006

Ecrou à six pans voir SO 40006

Hexagon nut see SO 40006

T-Verschraubung
Té égal
Tee union

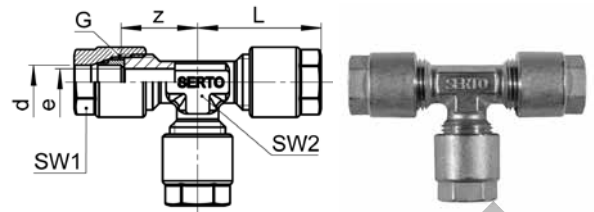

SO 03021

Type-d	Mat.-Nr.	bar	G	SW1	SW2	L	z	e	kg/100
Für metrische Rohre	Pour tubes métriques			For metric tubes					
SO 03021-4	248.3000.040	125	1/8	12	10	26.5	20.0	3.4	4.910
SO 03021-5	248.3000.050	125	1/8	12	10	27.0	20.0	4.0	5.040
SO 03021-6	248.3000.060	125	1/8	12	10	28.0	20.0	4.0	5.230
SO 03021-8	248.3000.080	125	1/4	14	11	31.5	22.0	6.0	9.610
SO 03021-10	248.3000.100	100	3/8	17	14	35.0	23.0	8.0	15.480
SO 03021-12	248.3000.120	100	1/2	19	19	39.0	26.0	11.0	27.750
SO 03021-14	248.3000.140	64	1/2	22	19	42.5	26.5	11.0	29.730
SO 03021-15	248.3000.150	64	1/2	22	19	42.5	26.5	11.0	28.800
Für Zollrohre	Pour tubes pouces			For inch tubes					
SO 03021-6,35	248.3000.063	125	1/8	12	10	28.0	20.0	4.0	5.130
SO 03021-9,52	248.3000.095	100	3/8	17	14	35.0	23.0	8.0	15.610
SO 03021-12,7	248.3000.127	100	1/2	22	19	40.5	26.0	11.0	29.630

Umrechnung für "d" bei Zollrohren:

- 6,35 = 1/4
- 9,52 = 3/8
- 12,7 = 1/2

Conversion de "d" pour tubes en pouces:

- 6,35 = 1/4
- 9,52 = 3/8
- 12,7 = 1/2

Conversion for "d" for inch tubes:

- 6,35 = 1/4
- 9,52 = 3/8
- 12,7 = 1/2

d=Rohrassens-ø
 e=kleinste Bohrung
 L=Mass in montiertem Zustand

d=ø extérieur du tube
 e=ø min. de passage
 L=après montage

d=tube outside diameter
 e=minimum bore
 L=installed length

T-Verschraubung reduziert
Té réduit
Tee reduction union

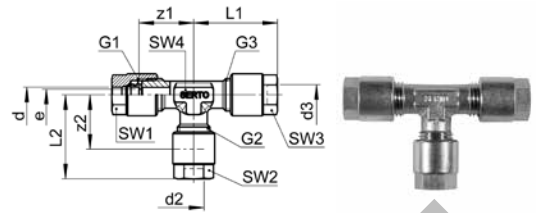

SO 03021 RED

Type -d -d2 -d3	Mat.-Nr.	bar	G1	G2	G3	SW1	SW2	SW3	SW4	L1	L2	z1	z2	e	Vers.	kg/100
SO 03021-6-8-6	248.3004.058	125	1/4	1/4	1/4	14	14	14	11	31.0	32.0	22.0	22.0	4.5	V0	9.610
SO 03021-6-10-6	248.3004.062	100	3/8	3/8	3/8	17	17	17	14	34.0	35.0	23.0	23.0	5.0	V0	12.540
SO 03021-6-10-10	248.3004.158	100	1/4	3/8	3/8	14	17	17	14	32.0	35.0	23.0	23.0	4.5	V1	13.960
SO 03021-8-6-6	248.3004.091	125	1/4	1/4	1/4	14	14	14	11	32.0	31.0	22.0	22.0	4.5	V0	9.610
SO 03021-8-6-8	248.3004.093	125	1/4	1/4	1/4	14	14	14	11	32.0	31.0	22.0	22.0	4.5	V0	9.610
SO 03021-8-8-6	248.3004.100	125	1/4	1/4	1/4	14	14	14	11	32.0	32.0	22.0	22.0	4.5	V0	9.610
SO 03021-8-8-10	248.3004.151	100	3/8	3/8	3/8	17	17	17	14	35.0	35.0	23.0	23.0	7.0	V0	12.600
SO 03021-8-8-12	248.3004.206	100	1/2	1/2	1/2	19	19	19	19	37.5	37.5	26.0	26.0	7.0	V0	20.400
SO 03021-8-10-8	248.3004.104	100	3/8	3/8	3/8	17	17	17	14	33.0	35.0	23.0	23.0	6.5	V0	12.540
SO 03021-8-10-10	248.3004.161	100	1/4	3/8	3/8	14	17	17	14	35.0	35.0	23.0	23.0	7.0	V1	13.950
SO 03021-8-12-8	248.3004.107	100	1/2	1/2	1/2	19	19	19	19	37.5	39.5	26.0	26.0	7.0	V0	21.120
SO 03021-8-12-12	248.3004.229	100	1/2	1/2	1/2	19	19	19	19	37.5	39.5	26.0	26.0	7.0	V0	23.760
SO 03021-8-14-14	248.3004.356	64	1/2	1/2	1/2	19	22	22	19	37.5	42.5	26.0	26.0	7.0	V0	25.080
SO 03021-8-15-15	248.3004.430	64	1/2	1/2	1/2	19	22	22	19	37.5	42.5	26.0	26.0	7.0	V0	24.460
SO 03021-10-6-10	248.3004.147	100	3/8	1/4	3/8	17	14	17	14	35.0	32.0	23.0	23.0	4.5	V2	13.850
SO 03021-10-8-10	248.3004.153	100	3/8	1/4	3/8	17	14	17	14	35.0	33.0	23.0	23.0	7.0	V2	13.850
SO 03021-10-10-12	248.3004.220	100	1/2	1/2	1/2	19	19	19	19	38.0	38.0	26.0	26.0	9.0	V0	22.290
SO 03021-10-10-15	248.3004.403	64	1/2	1/2	1/2	19	19	22	19	38.0	38.0	26.0	26.5	9.0	V0	22.650
SO 03021-10-12-10	248.3004.165	100	1/2	1/2	1/2	19	19	19	19	38.0	39.5	26.0	26.0	7.0	V0	20.930
SO 03021-10-12-12	248.3004.232	100	1/2	1/2	1/2	19	19	19	19	38.0	39.5	26.0	26.0	9.0	V0	23.660
SO 03021-10-12-14	248.3004.340	64	1/2	1/2	1/2	19	19	22	19	38.0	39.5	26.0	26.0	9.0	V0	24.320
SO 03021-10-12-15	248.3004.415	64	1/2	1/2	1/2	19	19	22	19	38.0	39.5	26.0	26.0	9.0	V0	24.010
SO 03021-10-14-12	248.3004.244	64	1/2	1/2	1/2	19	22	19	19	38.0	42.5	26.0	26.0	9.0	V0	24.320
SO 03021-10-15-10	248.3004.175	64	1/2	1/2	1/2	19	22	19	19	38.0	42.5	26.5	26.5	7.0	V0	21.280
SO 03021-10-15-12	248.3004.252	64	1/2	1/2	1/2	19	22	19	19	38.0	42.5	26.0	26.0	9.0	V0	24.010
SO 03021-10-15-15	248.3004.433	64	1/2	1/2	1/2	19	22	22	19	38.0	42.5	26.0	26.0	9.0	V0	24.360
SO 03021-12-6-12	248.3004.200	100	1/2	3/8	1/2	19	17	19	19	39.5	37.0	26.0	27.0	4.5	V2	24.970
SO 03021-12-8-12	248.3004.210	100	1/2	3/8	1/2	19	17	19	19	39.5	38.0	26.0	26.0	7.0	V2	24.920
SO 03021-12-10-12	248.3004.222	100	1/2	3/8	1/2	19	17	19	19	39.5	38.0	26.0	26.0	9.0	V2	24.830
SO 03021-12-14-12	248.3004.246	64	1/2	1/2	1/2	19	22	19	19	39.5	42.5	26.0	26.5	11.0	V0	28.410
SO 03021-12-15-12	248.3004.254	64	1/2	1/2	1/2	19	22	19	19	39.5	42.5	26.0	26.5	11.0	V0	28.100

Anwendungsbeispiele:

Exemples d'utilisation:

Sample combinations:

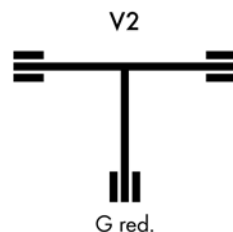
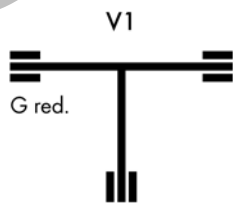

V0 = nicht reduziertes Grundteil

V1 - V2 = Versionen mit reduziertem Grundteil

V0 = corps de raccord non réduit

V1 - V2 = versions avec corps de raccord réduit

V0 = not reduced union body

V1 - V2 = versions with reduced union bodies

Fortsetzung nächste Seite

Suite à la prochaine page

Continued on next page

d=Rohrøussen-ø
 e=kleinste Bohrung
 L=Mass in montiertem Zustand

d=ø extérieur du tube
 e=ø min. de passage
 L=après montage

d=tube outside diameter
 e=minimum bore
 L=installed length

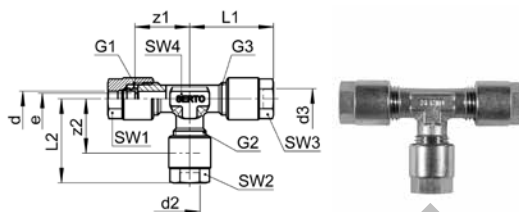
T-Verschraubung reduziert
Té réduit
Tee reduction union

SO 03021 RED

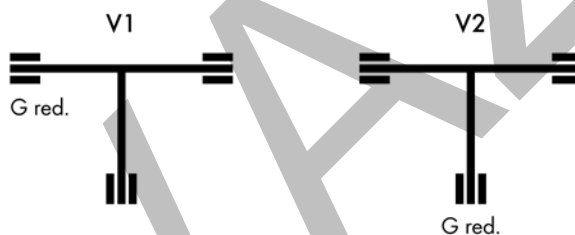
Type -d -d2 -d3	Mat.-Nr.	bar	G1	G2	G3	SW1	SW2	SW3	SW4	L1	L2	z1	z2	e	Vers.	kg/100
SO 03021-14-8-14	248.3004.320	64	1/2	3/8	1/2	22	17	22	19	42.5	38.0	26.5	26.0	7.0	V2	26.250
SO 03021-14-10-12	248.3004.330	64	1/2	3/8	1/2	22	17	19	19	42.5	38.0	26.5	26.0	9.0	V2	25.490
SO 03021-14-12-12	248.3004.342	64	1/2	1/2	1/2	22	19	19	19	42.5	39.5	26.5	26.5	11.0	V0	28.410
SO 03021-14-12-14	248.3004.346	64	1/2	1/2	1/2	22	19	22	19	42.5	39.5	26.0	26.5	11.0	V0	29.070
SO 03021-14-14-12	248.3004.361	64	1/2	1/2	1/2	22	22	19	19	42.5	42.5	26.5	26.5	11.0	V0	29.070
SO 03021-15-8-15	248.3004.393	64	1/2	3/8	1/2	22	17	22	19	42.5	38.0	26.5	26.0	7.0	V2	25.630
SO 03021-15-10-12	248.3004.405	64	1/2	3/8	1/2	22	17	19	19	42.5	38.0	26.5	26.0	9.0	V2	25.180
SO 03021-15-10-15	248.3004.410	64	1/2	3/8	1/2	22	17	22	19	42.5	38.0	26.5	26.0	9.0	V2	25.530
SO 03021-15-12-12	248.3004.417	64	1/2	1/2	1/2	22	19	19	19	42.5	39.5	26.5	26.5	11.0	V0	28.100
SO 03021-15-12-15	248.3004.422	64	1/2	1/2	1/2	22	19	22	19	42.5	39.5	26.0	26.5	11.0	V0	28.450
SO 03021-15-15-12	248.3004.435	64	1/2	1/2	1/2	22	22	19	19	42.5	42.5	26.5	26.5	11.0	V0	28.450

3
Anwendungsbeispiele:
Exemples d'utilisation:
Sample combinations:

V0 = nicht reduziertes Grundteil

V0 = corps de raccord non réduit

V0 = not reduced union body

V1 - V2 = Versionen mit reduziertem Grundteil

V1 - V2 = versions avec corps de raccord réduit

V1 - V2 = versions with reduced union bodies

T-Verschraubung

mit Übergangsnippel SO 00040

Té égal

avec adaptateur mâle SO 00040

Tee union

with male adaptor SO 00040

SO 03121

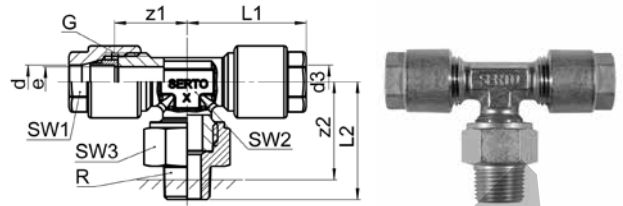

Type -d-R-d3	Mat.-Nr.	bar	G	SW1	SW2	SW3	L1	L2	z1	z2	e	kg/100
R=Rohrgewinde (kegelig)			R=Filetage-gaz BSP (conique)									
			R=BSP thread (tapered)									
SO 03121-6-1/8-6	248.3101.100	125	1/8	10	12	14	29.0	29.5	20.0	24.5	4.0	5.510
SO 03121-6-1/4-6	248.3101.110	125	1/4	11	14	17	32.0	37.0	22.0	29.0	4.5	7.630
SO 03121-6-3/8-6	248.3101.120	125	1/4	11	14	17	32.0	37.0	22.0	29.0	4.5	10.880
SO 03121-8-1/8-8	248.3101.160	125	1/4	11	14	17	32.5	33.0	22.0	28.0	7.0	9.460
SO 03121-8-1/4-8	248.3101.170	125	1/4	11	14	17	32.5	37.0	22.0	29.0	6.0	7.630
SO 03121-8-3/8-8	248.3101.180	125	3/8	14	17	22	36.0	39.5	23.0	31.5	7.0	13.790
SO 03121-10-1/4-10	248.3101.270	100	3/8	14	17	22	36.0	39.5	23.0	31.5	8.0	15.880
SO 03121-10-3/8-10	248.3101.280	100	3/8	14	17	22	36.0	39.5	23.0	31.5	8.0	16.740
SO 03121-10-1/2-10	248.3101.290	100	1/2	19	19	27	41.0	44.5	27.0	34.5	9.0	21.970
SO 03121-12-1/4-12	248.3101.380	100	1/2	19	19	27	40.5	42.5	26.0	34.5	8.5	27.830
SO 03121-12-3/8-12	248.3101.390	100	1/2	19	19	27	40.5	42.5	26.0	34.5	10.0	27.910
SO 03121-12-1/2-12	248.3101.400	100	1/2	19	19	27	40.5	44.5	26.0	34.5	11.0	28.790
SO 03121-12-3/4-12	248.3101.410	100	1/2	19	19	30	40.5	46.5	26.0	34.5	11.0	33.800
SO 03121-14-1/2-14	248.3101.540	64	1/2	19	22	27	44.0	44.5	26.5	34.5	12.0	30.110
SO 03121-15-1/2-15	248.3101.590	64	1/2	19	22	27	44.0	44.5	26.5	34.5	12.0	29.500

T-Verschraubung

mit Übergangsnippel SO 00040 NPT

Té égal

avec adaptateur mâle SO 00040 NPT

Tee union

with male adaptor SO 00040 NPT

SO 03121 NPT

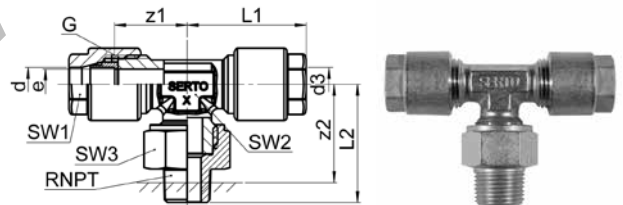

Type -d-RNPT-d3	Mat.-Nr.	bar	G	SW1	SW2	SW3	L1	L2	z1	z2	e	kg/100
RNPT=NPT Gewinde			RNPT=Filetage NPT									
			RNPT=NPT thread									
SO 03121-8-1/4 NPT-8	248.3102.170	150	1/4	14	11	17	32.0	39.0	22.0	29.0	6.0	10.270
SO 03121-10-1/4 NPT-10	248.3102.270	125	3/8	17	14	22	35.0	41.5	23.0	31.5	8.0	15.990

Montagehinweis: Nippel ist handfest montiert. Bei Endmontage mit 1/4 Umdrehung anziehen.

Wir empfehlen eine zusätzliche Schmierung auf der Planfläche.

Note d'installation: L'adaptateur femelle-mâle est monté serré à la main. Pour le montage final, serrer avec 1/4 de tour.

Nous recommandons une lubrification supplémentaire sur la surface plane.

Assembly information: Male adaptor is mounted finger-tight. For final assembly, tighten with 1/4 turn.

We recommend additional lubrication on the plane surface.

T-Verschraubung

mit Übergangsmuffe SO 00030

Té égal

avec adaptateur femelle SO 00030

Tee union

with female adaptor SO 00030

SO 03221

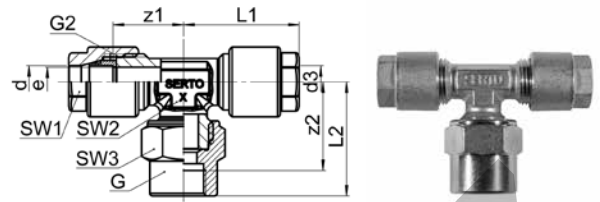

Type -d-G-d3	Mat.-Nr.	bar	G2	SW1	SW2	SW3	L1	L2	z1	z2	e	kg/100
G=Rohrgewinde (zylindrisch)	G=Filetage-gaz BSP (cylindrique)	G=BSP thread (parallel)										
SO 03221-6-1/8-6	248.3201.100	125	1/8	10	12	14	28.0	33.5	20.0	23.5	4.0	6.090
SO 03221-6-1/4-6	248.3201.110	125	1/4	11	14	19	31.0	37.0	22.0	26.0	4.5	11.340
SO 03221-6-3/8-6	248.3201.120	125	1/4	11	14	22	31.0	38.5	22.0	26.5	4.5	13.000
SO 03221-8-1/8-8	248.3201.160	125	1/4	11	14	17	31.5	35.5	22.0	25.5	6.0	10.010
SO 03221-8-1/4-8	248.3201.170	125	1/4	11	14	19	31.5	37.0	22.0	26.0	6.0	11.340
SO 03221-8-3/8-8	248.3201.180	125	3/8	14	17	24	34.5	39.5	23.0	27.5	7.0	15.590
SO 03221-10-1/4-10	248.3201.270	100	3/8	14	17	22	34.5	38.0	23.0	27.0	8.0	16.780
SO 03221-10-3/8-10	248.3201.280	100	3/8	14	17	24	35.0	39.5	23.0	27.5	8.0	18.540
SO 03221-10-1/2-10	248.3201.290	100	1/2	19	19	30	39.0	45.0	26.5	31.0	9.0	26.580
SO 03221-12-3/8-12	248.3201.390	100	1/2	19	19	27	40.0	42.5	26.5	30.5	10.0	29.760
SO 03221-12-1/2-12	248.3201.400	100	1/2	19	19	30	40.0	45.0	26.5	31.0	11.0	33.400
SO 03221-12-3/4-12	248.3201.410	100	1/2	19	19	32	40.0	48.5	26.5	31.5	11.0	34.860
SO 03221-14-1/2-14	248.3201.540	64	1/2	19	22	30	42.5	45.0	26.5	31.0	12.0	34.730
SO 03221-15-3/8-15	248.3201.580	64	1/2	19	22	24	42.5	42.5	26.5	30.5	8.0	28.580
SO 03221-15-1/2-15	248.3201.590	64	1/2	19	22	30	42.5	45.0	26.5	31.0	12.0	34.110

Montagehinweis: Muffe ist handfest montiert. Bei Endmontage mit 1/4 Umdrehung anziehen.

Wir empfehlen eine zusätzliche Schmierung auf der Planfläche.

Note d'installation: L'adaptateur femelle est monté serré à la main. Pour le montage final, serrer avec 1/4 de tour.

Nous recommandons une lubrification supplémentaire sur la surface plane.

Assembly information: Female adaptor is mounted finger-tight. For final assembly, tighten with 1/4 turn.

We recommend additional lubrication on the plane surface.

Einstellbare T-Verschraubung

Té orientable au centre

Adjustable tee union

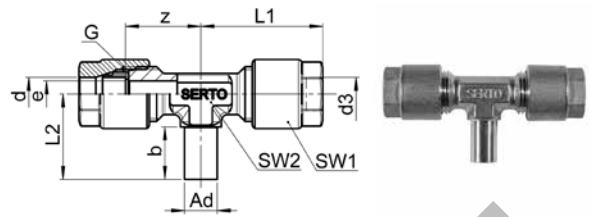

SO 03621 T

Type -d -Ad -d3	Mat.-Nr.	bar	G	SW1	SW2	L1	L2	b	z	e	kg/100
SO 03621-6-A6-6	248.3600.060	125	1/8	12	10	28.0	19.0	13.0	20.0	4.0	3.890
SO 03621-8-A8-8	248.3600.080	125	1/4	14	11	31.5	22.0	14.0	22.0	6.0	6.980
SO 03621-10-A10-10	248.3600.100	100	3/8	17	14	35.0	26.0	16.0	23.0	8.0	11.340

Anwendungsbeispiele:

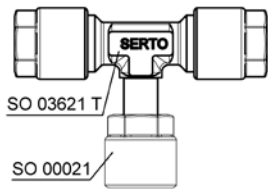

Mögliche Kombinationen:

- mit Armaturenanschluss zu einstellbaren T-Verschraubungen
- mit Verschraubungen zu einstellbaren Verschraubungen
- mit Einschraubverschraubungen zu einstellbaren T-Einschraubverschraubungen. Gegenüber der T-Einschraubverschraubung lässt sich diese Kombination einfacher einstellen, da Einschrauben und Ausrichten getrennt voneinander vorgenommen werden.

Exemples d'utilisation:

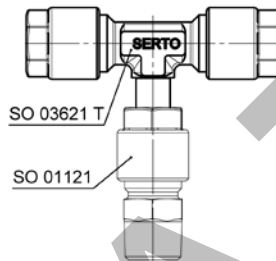

Combinaisons possibles:

- avec écrou de raccordement ça donne un Té orientable
- avec raccords ça donne des raccords orientables
- avec une union mâle ça donne un Té fileté orientable. Par rapport au Té orientable, cette combinaison est facile à régler, puisque le vissage et l'alignement sont réalisés séparément l'un de l'autre.

Sample combinations:

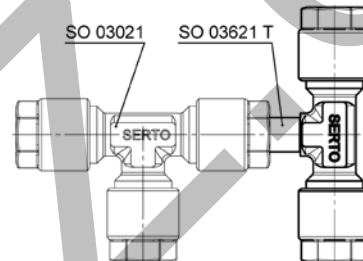

Possible combinations:

- with nut connections to adjustable tee unions
- with unions to adjustable unions
- with male adaptor unions to adjustable male adaptor tee unions. This combination is simpler to produce, as screwing in and alignment are carried out separately.

d=Rohrassen- \emptyset
 Ad=Aussen- \emptyset der Andrehung
 e=kleinste Bohrung
 L=Mass in montiertem Zustand

d= \emptyset extérieur du tube
 Ad= \emptyset extérieur de la portée cylindrique
 e= \emptyset -min. de passage
 L=après montage

d=tube outside diameter
 Ad=outside diameter of cyl. stub
 e=minimum bore
 L=installed length

Einstellbare L-Verschraubung

Té orientable en bout

Adjustable L union

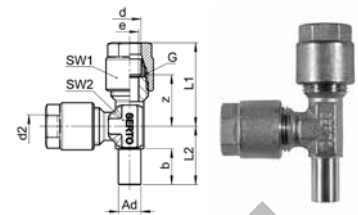

SO 03621 L

Type -d -d2 -Ad	Mat.-Nr.	bar	G	SW1	SW2	L1	L2	b	z	e	kg/100
SO 03621-6-6-A6	248.3610.060	125	1/8	12	10	28.0	19.0	13.0	20.0	4.0	3.890
SO 03621-8-8-A8	248.3610.080	125	1/4	14	11	31.5	22.0	14.0	22.0	6.0	7.020
SO 03621-10-10-A10	248.3610.100	100	3/8	17	14	35.0	26.0	16.0	23.0	8.0	11.560

Anwendungsbeispiele:

Exemples d'utilisation:

Sample combinations:

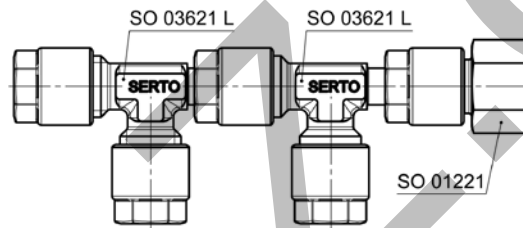
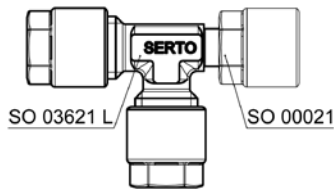

Mögliche Kombinationen:

- mit Armaturenanschluss zu einstellbaren L-Verschraubungen
- mit Verschraubungen zu einstellbaren Verschraubungen
- mit Einschraubverschraubungen zu einstellbaren L-Einschraubverschraubungen. Gegenüber der L-Einschraubverschraubung lässt sich diese Kombination einfacher einstellen, da Einschrauben und Ausrichten getrennt voneinander vorgenommen werden.

Combinaisons possibles:

- avec écrou de raccordement ça donne un L orientable
- avec raccords ça donne des raccords orientables
- avec une union mâle ça donne un L fileté orientable. Par rapport au L orientable, cette combinaison est facile à régler, puisque le vissage et l'alignement sont réalisés séparément l'un de l'autre.

Possible combinations:

- with nut connections to adjustable L unions
- with unions to adjustable unions
- with male adaptor unions to adjustable male adaptor L unions. This combination is simpler to produce, as screwing in and alignment are carried out separately.

3

d=Rohrassen- \emptyset
Ad=Aussen- \emptyset der Andrehung
e=kleinste Bohrung
L=Mass in montiertem Zustand

d= \emptyset extérieur du tube
Ad= \emptyset extérieur de la portée cylindrique
e= \emptyset -min. de passage
L=après montage

d=tube outside diameter
Ad=outside diameter of cyl. stub
e=minimum bore
L=installed length

T-Einschraubverschraubung
Té mâle au centre
Male adaptor Tee union

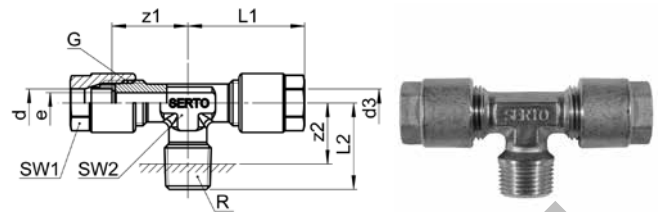

SO 03721 T

Type -d -R -d3	Mat.-Nr.	bar	G	SW1	SW2	L1	L2	z1	z2	e	kg/100
Für metrische Rohre R=Rohrgewinde (kegelig)	Pour tubes métriques R=Filetage-gaz BSP (conique)										

Für Zollrohre	Pour tubes pouces										

Umrechnung für "d" bei Zollrohren:
 6,35 = 1/4
 9,52 = 3/8

Conversion de "d" pour tubes en pouces:
 6,35 = 1/4
 9,52 = 3/8

Conversion for "d" for inch tubes:
 6,35 = 1/4
 9,52 = 3/8

d=Rohraussen-ø
 e=kleinste Bohrung
 L=Mass in montiertem Zustand

d=ø extérieur du tube
 e=ø-min. de passage
 L=après montage

d=tube outside diameter
 e=minimum bore
 L=installed length

L-Einschraubverschraubung

Té mâle en bout

Male adaptor L union

SO 03721 L

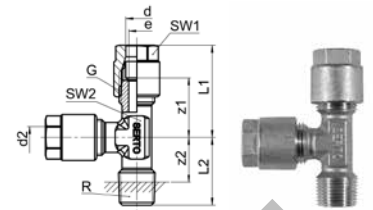

Type -d -d2 -R	Mat.-Nr.	bar	G	SW1	SW2	L1	L2	z1	z2	e	kg/100
Für metrische Rohre R=Rohrgewinde (kegelig)	Pour tubes métriques R=Filetage-gaz BSP (conique)	For metric tubes R=BSP thread (tapered)									
SO 03721-4-4-1/8	248.3711.050	125	1/8	12	10	27.0	20.0	20.0	13.5	3.4	4.100
SO 03721-5-5-1/8	248.3711.070	125	1/8	12	10	27.0	20.0	20.0	13.5	4.0	4.190
SO 03721-6-6-1/8	248.3711.100	125	1/8	12	10	28.0	20.0	20.0	13.5	4.0	4.310
SO 03721-6-6-1/4	248.3711.180	125	1/8	12	11	30.0	25.0	22.0	15.0	4.0	5.390
SO 03721-8-8-1/4	248.3711.220	125	1/4	14	11	31.5	25.0	22.0	15.0	6.0	7.830
SO 03721-10-10-1/4	248.3711.260	100	3/8	17	14	35.0	25.0	23.0	15.0	8.0	11.720
SO 03721-10-10-3/8	248.3711.320	100	3/8	17	14	35.0	25.0	23.0	16.0	8.0	12.620

Für Zollrohre	Pour tubes pouces	For inch tubes									
SO 03721-6,35-6,35-1/8	248.3711.110	125	1/8	12	10	28.0	20.0	20.0	13.5	4.0	4.250
SO 03721-6,35-6,35-1/4	248.3711.190	125	1/8	12	11	30.0	25.0	22.0	15.0	4.0	7.280
SO 03721-9,52-9,52-1/4	248.3711.240	100	3/8	17	14	35.0	25.0	23.0	15.0	8.0	11.810
SO 03721-9,52-9,52-3/8	248.3711.290	100	3/8	17	14	35.0	25.0	23.0	16.0	8.0	12.710

Umrechnung für "d" bei Zollrohren:

6,35 = 1/4
9,52 = 3/8

Conversion de "d" pour tubes en pouces:

6,35 = 1/4
9,52 = 3/8

Conversion for "d" for inch tubes:

6,35 = 1/4
9,52 = 3/8

Kreuzverschraubung
Croix égale
Cross union

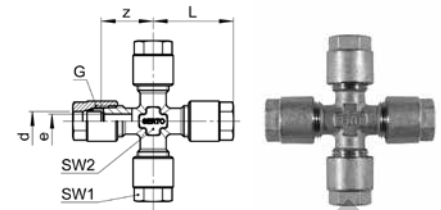

SO 04021

Type -d	Mat.-Nr.	bar	G	SW1	SW2	L	z	e	kg/100
Für metrische Rohre	Pour tubes métriques		For metric tubes						
SO 04021-4	248.4000.040	125	1/8	12	10	27.0	20.0	3.4	6.380
SO 04021-5	248.4000.050	125	1/8	12	10	28.0	20.0	4.0	6.550
SO 04021-6	248.4000.060	125	1/8	12	10	28.0	20.0	4.0	6.800
SO 04021-8	248.4000.080	125	1/4	14	11	31.5	22.0	6.0	12.410
SO 04021-10	248.4000.100	100	3/8	17	14	35.0	23.0	8.0	20.480
SO 04021-12	248.4000.120	100	1/2	19	19	42.0	29.0	11.0	35.510
SO 04021-14	248.4000.140	64	1/2	22	19	45.0	29.0	12.0	38.150
SO 04021-15	248.4000.150	64	1/2	22	19	45.0	29.0	12.0	36.910
Für Zollrohre	Pour tubes pouces		For inch tubes						
SO 04021-6,35	248.4000.063	125	1/8	12	10	28.0	20.0	4.0	6.670
SO 04021-9,52	248.4000.095	100	3/8	17	14	35.0	23.0	8.0	20.650
SO 04021-12,7	248.4000.127	100	1/2	22	19	45.0	29.0	11.0	38.020

Umrechnung für "d" bei Zollrohren:

- 6,35 = 1/4
- 9,52 = 3/8
- 12,7 = 1/2

Conversion de "d" pour tubes en pouces:

- 6,35 = 1/4
- 9,52 = 3/8
- 12,7 = 1/2

Conversion for "d" for inch tubes:

- 6,35 = 1/4
- 9,52 = 3/8
- 12,7 = 1/2

Kreuzverschraubung reduziert
Croix réduite
Cross reduction union

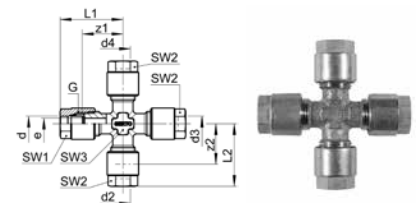

SO 04021 RED

Type -d -d2 -d3 -d4	Mat.-Nr.	bar	G	SW1	SW2	SW3	L1	L2	z1	z2	e	kg/100
Für metrische Rohre	Pour tubes métriques		For metric tubes									
SO 04021-8-6-6-6	248.4004.076	125	1/4	14	14	11	32.0	31.5	22.0	22.0	4.5	12.420
SO 04021-10-8-8-8	248.4004.097	100	3/8	17	17	14	35.5	35.0	23.0	23.0	7.0	20.770
SO 04021-12-10-10-10	248.4004.117	100	1/2	19	19	19	44.0	42.0	29.0	29.0	9.0	34.160
SO 04021-14-10-10-10	248.4004.135	64	1/2	22	19	19	49.5	45.0	29.0	29.0	9.0	34.820
SO 04021-14-12-12-12	248.4004.137	64	1/2	22	19	19	49.5	45.0	29.0	29.0	11.0	36.170
SO 04021-15-10-10-10	248.4004.144	64	1/2	22	19	19	47.5	45.0	29.0	29.0	9.0	34.520
SO 04021-15-12-12-12	248.4004.146	64	1/2	22	19	19	47.5	45.0	29.0	29.0	11.0	35.860

d=Rohraussen-ø
e=kleinste Bohrung
L=Mass in montiertem Zustand

d=ø extérieur du tube
e=ø-min. de passage
L=après montage

d=tube outside diameter
e=minimum bore
L=installed length

T-Winkelverschraubung
Té distributeur en V
3-way side outlet elbow

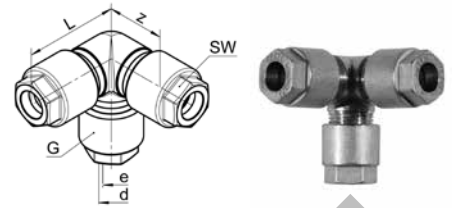

SO 05021

Type -d	Mat.-Nr.	bar	G	SW	L	z	e	kg/100
Für metrische Rohre	Pour tubes métriques			For metric tubes				
SO 05021-4	248.5000.040	125	1/8	12	27.0	20.0	3.4	5.230
SO 05021-5	248.5000.050	125	1/8	12	28.0	20.0	4.0	5.360
SO 05021-6	248.5000.060	125	1/8	12	28.0	20.0	4.0	5.550
SO 05021-8	248.5000.080	125	1/4	14	31.5	22.0	6.0	10.790
SO 05021-10	248.5000.100	100	3/8	17	35.0	23.0	8.0	17.700
SO 05021-12	248.5000.120	100	1/2	19	42.5	29.0	11.0	30.840
SO 05021-14	248.5000.140	64	1/2	22	45.5	29.5	12.0	32.820
SO 05021-15	248.5000.150	64	1/2	22	45.5	29.5	12.0	31.890
Für Zollrohre	Pour tubes pouces			For inch tubes				
SO 05021-6,35	248.5000.063	125	1/8	12	28.0	20.0	4.0	5.450
SO 05021-9,52	248.5000.095	100	3/8	17	35.0	23.0	8.0	17.820
SO 05021-12,7	248.5000.127	100	1/2	22	45.5	29.5	11.0	32.720

Umrechnung für "d" bei Zollrohren:

- 6,35 = 1/4
- 9,52 = 3/8
- 12,7 = 1/2

Conversion de "d" pour tubes en pouces:

- 6,35 = 1/4
- 9,52 = 3/8
- 12,7 = 1/2

Conversion for "d" for inch tubes:

- 6,35 = 1/4
- 9,52 = 3/8
- 12,7 = 1/2

T-Winkelverschraubung reduziert
Té distributeur en V réduit
3-way side outlet reduction elbow

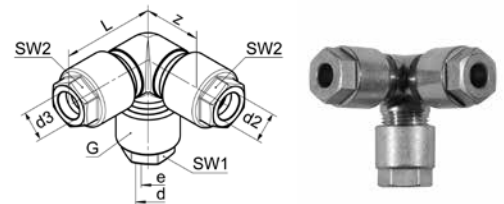

SO 05021 RED

Type -d -d2 -d3	Mat.-Nr.	bar	G	SW1	SW2	L	z	e	kg/100
SO 05021-8-6-6	248.5004.091	125	1/4	14	14	31.5	22.0	4.5	10.790
SO 05021-10-8-8	248.5004.151	100	3/8	17	17	35.0	23.0	7.0	17.890
SO 05021-12-10-10	248.5004.220	100	1/2	19	19	42.5	29.0	9.0	29.940
SO 05021-14-10-10	248.5004.328	64	1/2	22	19	45.5	29.5	9.0	30.420
SO 05021-14-12-12	248.5004.342	64	1/2	22	19	45.5	29.5	11.0	31.500
SO 05021-15-10-10	248.5004.403	64	1/2	22	19	45.5	29.5	9.0	30.290
SO 05021-15-12-12	248.5004.417	64	1/2	22	19	45.5	29.5	11.0	31.190

d=Rohrassens-ø
 e=kleinste Bohrung
 L=Mass in montiertem Zustand

d=ø extérieur du tube
 e=ø-min. de passage
 L=après montage

d=tube outside diameter
 e=minimum bore
 L=installed length

Ventile Messing G

Vannes laiton G

Valves brass G

SO NV 01A21



Reguliertventil
Vanne de réglage
Regulating valve

507

SO NV 01C21



Feinreguliertventil
Vanne de réglage fin
Fine regulating valve

508

SO NV 01A21E



Regulier-Eckventil
Vanne-équerre de réglage
Elbow regulating valve

511

SO NV 01A21EL



Regulier-Eckventil mit Einstellzapfen
Vanne-équerre de réglage orientable
Elbow regulating valve adjustable

512

SO NV 01A21ET



Regulier-Eckventil Schalttafel Ausführung
Vanne-équerre de réglage pour tableau de commande
Elbow regulating valve for panel mounting

512

SO NV 01C21E



Feinregulier-Eckventil
Vanne-équerre de réglage fin
Elbow fine regulating valve

513

SO NV 01D21E



Dosier-Eckventil mit Feinregulierspindel 1:50
Vanne-équerre de réglage de précision à aiguille 1:50
Metering elbow valve with fine-regulating spindle 1:50

513

SO NV 01D21ET



Dosier-Eckventil mit Feinregulierspindel 1:50, Schottausführung
Vanne-équerre de réglage de précision à aiguille 1:50, traversée de cloison
Metering elbow valve with fine-regulating spindle 1:50, panel mount

513

SO CV 03A21



Kegelrückschlagventil
Clapet anti-retour à siège conique
Taper seat non-return valve

516

SO BV 08C00



Kugelhahn voller Durchgang Dichtung von innen gesichert
Vanne à bille avec passage intégral monobloc
Ball valve with full flow seal locked from the inside

517

SO PV 08E01



Durchgangshahn mit Dichtkegelanschluss 60°
Vanne simple à passage direct avec raccord à étanchéité sur cône 60°
Total-flow cock with cone seat connection 60°

518

SO PV 08E21



Durchgangshahn
Vanne simple à passage direct
Total-flow cock

518

Ventile Messing G**Vannes laiton G****Valves brass G****SO 09900**

Anschraubfuß
Support de fixation
Flange mount

552**SO 09950**

Handrad für Regulierventile Messing M und G, Polyamid
Volant pour vannes de réglage laiton M e G, polyamide
Handwheel for regulating valves brass M and G, polyamide

552**VSD SO NV**

Ventilschilder (Satz)
Plaques signalétiques (set)
Valve labels (set)

553

Adapter Messing G

Adaptateurs laiton G

Adaptors brass G

SO 01020



Doppelnippel G-G
Mamelon double G-G
Male threaded adaptor G-G

678

SO 01020 RED



Doppelnippel G-G reduziert
Mamelon double G-G réduit
Reducing male threaded adaptor G-G

678

SO 01100



Doppelnippel G-R
Mamelon double G-R
Male threaded adaptor G-R

679

SO 01104



Doppelnippel G-G mit Dichtkante
Mamelon double G-G avec arête
d'étanchéité
Male threaded adaptor G-G with edge seal

679

SO 01200



Übergangsnippel G-G
Adaptateur mâle G - femelle G
Male adaptor G-G

680

SO 01500



Schott-Doppelnippel
Mamelon double traversée de cloison
Panel mount male threaded adaptor

680

SO 01504



Schott-Doppelnippel lang
Mamelon double traversée de cloison long
Panel mount male threaded adaptor long

680

SO 02000



Winkel G
Coude G
Elbow G

681

SO 02400



Winkel G-R
Coude G-R
Elbow G-R

681

SO 02400 NPT



Winkel G-NPT
Coude G-NPT
Elbow G-NPT

682

SO 03000



T-Stück G
Pièce Té G
T-piece G

682

Messing SAE

Verschraubungen und
Zubehör

Laiton SAE

Raccords et accessories

Brass SAE

Unions and accessories



Seite/Page/Page

216

Verschraubungskit SAE
Kit raccords SAE
Kit unions SAE



SO 40231 SAE

217

Aufweitorn SAE
Outil de calibrage SAE
Calibration tool SAE



AC 957

217

Kalibrierwerkzeug SAE
Matrice de calibrage SAE
Calibration tool SAE



AC 950

Sonderausführungen auf Anfrage
Exécution en option sur demande
Optional services on request



Chemisch vernickelt
Nickelage chimique
Chemical nickel-plated

Bestätigungen auf www.serto.com
Confirmations sur www.serto.com
Confirmations on www.serto.com



Messing SAE

Laiton SAE

Brass SAE

Eigenschaften, Besonderheiten

- einfache, schnelle Montage
- kompakte Baumasse
- CETIM-geprüft, entspricht den Normen und Empfehlungen der Kälteindustrie
- kein Lötanschluss oder Bördeln mehr nötig
- mit Werkzeugen zur Rohrkalibrierung

Funktionsprinzip

Siehe Kapitel i

Anwendung

Speziell für die Montage von Leitungen in der Kälte-/Klimaindustrie. Direkter Anschluss auf den SAE-Konus.

Werkstoff

Messing CuZn40Pb2 (CW 617N), Oberfläche gebeizt

Betriebsdruck PN

Siehe Produkttabellen (4-fache Sicherheit)

Temperaturbereich

-196 °C bis +180 °C

Helium-Leckrate

10⁻⁶ mbar • l/s *

Vakuum

Bis 10⁻⁴ mbar, höhere Werte möglich

Anzuschliessende Röhre

Nahtlose, gezogene Kupferrohre (insbes. EN 12449/1057) mit sauberer, glatter Oberfläche. Toleranz Aussendurchmesser ± 0.1 mm. Siehe auch Kapitel i und Kapitel 19. Weitere Materialien auf Anfrage.

Druckauswertungsgrad in % des PN



* bei fachgerechter Montage; siehe Kapitel i:
- Montageanleitung
- Rohrempfehlungen

Propriétés, spécificités

- montage facile et rapide
- compactes dimensions
- raccord attesté CETIM, conformité avec les normes et recommandations de l'industrie de la réfrigération
- ne nécessite ni raccord soudé ni collerette
- avec des outils pour calibration des tubes

Principe de fonctionnement

Voir chapitre i

Application

Développé pour l'industrie de la réfrigération et de la climatisation. Raccordement direct sur le cône SAE.

Matériau

Laiton CuZn40Pb2 (CW 617N), la surface est décapée

Pression de service PN

Voir tableaux des produits (facteur de sécurité 4)

Plage de température admissible

-196 °C à +180 °C

Débit de fuite avec hélium

10⁻⁶ mbar • l/s *

Vide

Jusqu'à 10⁻⁴ mbar, valeurs plus élevées possible

Tubes à utiliser

Tubes en cuivre sans soudure (selon EN 12449/1057) avec surface propre et lisse. Tolérance du diamètre extérieur de ± 0.1 mm. Voir aussi chapitre i et chapitre 19. Autres matériaux sur demande.

Coefficient de pression de service admissible en % de PN

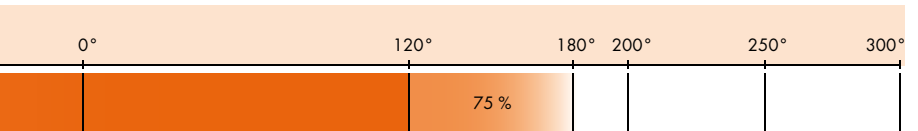

* à la base d'un montage dans les règles de l'art;
voir chapitre i:
- Instructions de montage
- Recommandations pour tubes

Characteristics, specialities

- easy and fast to install
- compact size
- CETIM-tested, conforms to standards and guidelines of the cooling industry
- no more soldering, brazing or flaring
- with calibration tools for tubes

Operating principle

See chapter i

Application

Specifically developed for the cooling/air-conditioning industry. Connects directly to the SAE cone.

Material

Brass CuZn40Pb2 (CW 617N), the surface is pickled

Working pressure PN

See product tables (safety factor 4)

Temperature range

-196 °C to +180 °C

Leak rate with helium

10⁻⁶ mbar • l/s *

Vacuum

Up to 10⁻⁴ mbar, higher values are possible

Tubes to use

Seamless copper tubes (esp. EN 12449/1057) with clean smooth surface. Tolerance of outside diameter ± 0.1 mm. See also chapter i and chapter 19. Further materials on demand.

Pressure coefficient % of PN

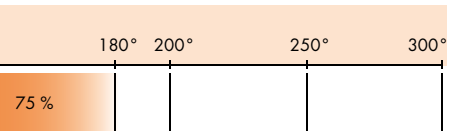

* when professionally assembled; see chapter i:
- Installation instructions
- Recommendations for tubes

Verschraubungskit SAE
Kit raccords SAE
Kit unions SAE

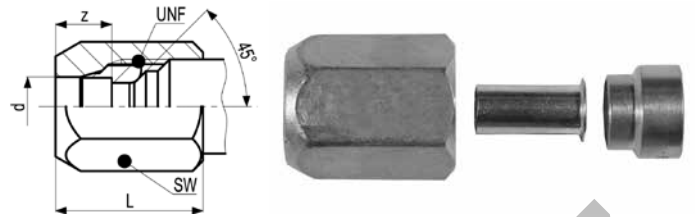

SO 40231 SAE

Type -d / -s		bar	UNF	SW	L	z	kg/100
Für metrische Rohre	Pour tubes métriques						
SO 40231-6 SAE/1,00	416.2388.060	100	7/16-20	17	20.0	6.5	3.000
SO 40231-10 SAE/1,00	416.2388.100	64	5/8-18	19	25.0	9.5	4.100
SO 40231-12 SAE/1,00	416.2388.120	45	3/4-16	22	31.0	12.5	6.200
SO 40231-16 SAE/1,00	416.2388.160	45	7/8-14	27	31.0	12.5	9.500
Für Zollrohre	Pour tubes pouces						
SO 40231-1/4 SAE/0,80	416.2384.063	100	7/16-20	17	20.0	6.5	3.000
SO 40231-3/8 SAE/0,80	416.2384.095	64	5/8-18	19	25.0	9.5	4.100
SO 40231-1/2 SAE/0,80	416.2384.127	45	3/4-16	22	31.0	12.5	6.200
SO 40231-5/8 SAE/0,80	416.2384.158	45	7/8-14	27	31.0	12.5	9.500
SO 40231-5/8 SAE/1,00	416.2388.158	45	7/8-14	27	31.0	12.5	9.500
SO 40231-3/4 SAE/1,00	416.2388.188	45	1 1/16-14 UNS	32	31.0	11.5	12.200

Kit mit Mutter, Klemmring und Stützhülse.
 Lieferung nur in Einheitspackungen; Details
 siehe Preisliste oder Online Shop.

Kit avec écrou, bague de serrage et douille
 d'appui.
 Livrable seulement dans des unités d'emballage;
 détails voir liste de prix ou Online Shop.

Kit with union nut, compression ferrule and stiffener sleeve.
 Delivery in packing units only; details see price
 list or Online Shop.

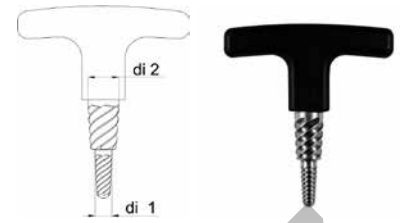
Aufweitdorn SAE
Outil de calibrage SAE
Calibration tool SAE

AC 957

Type	Mat.-Nr.	d	s	di1 - di2	kg/100
AC 957-1/4+1/2/0,80	988.8570.200	1/4"-1/2"	0.80	4.70-11.00	8.100
AC 957-3/8+5/8/0,80	988.8580.400	3/8"-5/8"	0.80	7.85-14.20	9.500
AC 957-3/8+5/8/0,80+0,90	988.8580.500	3/8"-5/8"	0.80-0.90	7.85-14.00	9.500
AC 957-3/4/0,90	988.8590.801	3/4"	0.90	17.20	8.900
AC 957-3/4/1,00	988.8590.900	3/4"	1.00	16.95	10.500

Für weiches Kupferrohr

Pour tubes en cuivre mou

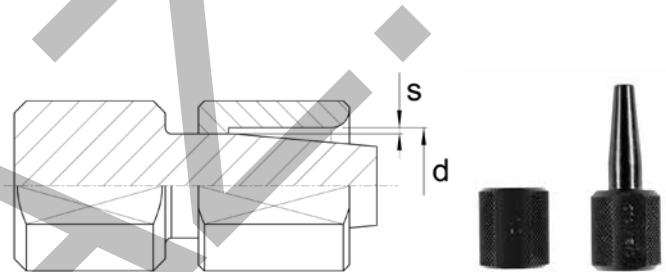
For soft copper tubes

Kalibrierwerkzeug SAE
Matrice de calibrage SAE
Calibration tool SAE

4
AC 950

Type	Mat.-Nr.	d	s	kg/100
Für metrische Rohre		Pour tubes métriques		For metric tubes
AC 950-6/1,00	988.8501.111	6	1.00	6.800
AC 950-10/1,00	988.8520.189	10	1.00	10.600
AC 950-12/1,00	988.8530.240	12	1.00	13.300
AC 950-16/1,00	988.8540.499	16	1.00	17.500

Für Zollrohre

Pour tubes pouces

For inch tubes

AC 950-1/4/0,80	988.8501.116	1/4"	0.80	6.700
AC 950-3/8/0,80	988.8520.190	3/8"	0.80	10.600
AC 950-1/2/0,80	988.8530.280	1/2"	0.80	13.000
AC 950-5/8/0,90	988.8540.500	5/8"	0.90	17.600
AC 950-5/8/1,00	988.8541.500	5/8"	1.00	17.400
AC 950-3/4/0,90	988.8550.640	3/4"	0.90	23.000

Für weiches Kupferrohr

Pour tubes en cuivre recuit

For soft copper tubes

Prototypen – schnell und günstig

Kunststoffteile konstruieren die SERTO-Techniker am PC. Sie legen Geometrien und Größen fest und übertragen diese in 3D-CAD-Programme. Aber bevor die neuen Teile in unseren Katalog aufgenommen werden, lassen wir Prototypen erstellen und testen diese ausgiebig

Rapid Prototyping ist ein Verfahren zur schnellen Herstellung von Musterbauteilen auf Basis von 3D-Konstruktionsdaten. Dabei wird das Werkstück schichtweise aus formlosem oder formneutralem Material aufgebaut. Es gibt für die Prototypherstellung drei unterschiedliche Verfahren: das selektive Lasersintern (SLS), 3D-Printing und Stereolithographie (STL).

Alle Verfahren unterstützen unsere Konstrukteure in einer schnellen Beurteilung ihrer Ideen und garantieren unseren Kunden funktionsfähige Lösungen. Und das alles innert kürzester Zeit, zu optimalen Kosten.

Prototypes – rapides et rentables

Les techniciens de SERTO conçoivent les pièces en plastique sur ordinateur. Ils déterminent les géométries et les dimensions et les reportent dans des logiciels de CAO en 3D. Mais avant d'intégrer les nouvelles pièces dans notre catalogue, nous faisons fabriquer des prototypes et les testons dans le détail.

Le Rapid Prototyping (prototypage rapide) est un procédé de fabrication rapide de modèles basé sur des données en 3D. La pièce est construite en couches à partir d'un matériau sans forme ou de forme neutre. Il existe trois procédés pour élaborer les prototypes: prole frittage laser sélectif (SLS), l'impression 3D et la stéréolithographie (STL).

Tous ces procédés aident nos constructeurs à évaluer rapidement leurs idées et garantissent à nos clients des solutions opérationnelles. Et tout ça dans les meilleurs délais, à des coûts optimaux.

Prototypes – fast and affordable

Plastic components are designed by SERTO engineers virtually on a computer. They determine the geometries and dimensions, entering them in 3D-CAD programmes. But before we can take the new components up in our catalogue, we must create prototypes and test them extensively.

Rapid Prototyping is an additive manufacturing process, which allows building prototype models by using virtual 3D data. The workpiece is constructed layer by layer from formless or form-neutral material. There are three different means of manufacturing prototypes: selective laser sintering (SLS), 3D printing and stereolithography (STL).

All these processes help our design engineers to assess their ideas quickly and also guarantee that our customers receive functional solutions. And all this in a very short time at optimal costs.



Bild links: Modell eines Ventiles, hergestellt durch Lasersintern



Bild rechts: Modell einer T-Verschraubung, hergestellt durch Stereolithographie, der Schichtaufbau ist deutlich erkennbar

Photo à gauche: Modèle d'une vanne, fabriquée par frittage laser

Photo left: A valve model, produced by laser sintering

Photo à droite: Modèle d'un raccord en T, fabriqué par stéréolithographie, on reconnaît nettement la formation des strates

Photo right: T-union model, produced by stereolithography, with a clearly visible layer structure

Edelstahl

Verschraubungen

























Acier inoxydable

Raccords

Stainless steel

Unions



	Seite/Page/Page		Seite/Page/Page		Seite/Page/Page
Klemmring Bague de serrage Compression ferrule	223-227 	Schlauchtülle Douille cannelée Hose nozzle	238-239 	Einstellbare Einschraubverschraubung Union mâle orientable Adjustable male adaptor union	261 
	SO 50001		SO 50503		SO 51335
Abschlusszapfen Bouchon d'arrêt Plug	228 	Anschlussnippel Ecrou de raccordement mâle Nipple connection	240 	Einstellbare Verschraubung Union orientable Adjustable union	262 
	SO 50002		SO 51001		SO 51345
Stützhülse Douille d'appui Stiffener sleeve	229 	Gerade Verschraubung Union double Straight union	241-242 	Anschweißverschraubung Union avec embout à souder Weld-on union	263 
	SO 50003		SO 51021		SO 51429
Sechskantmutter METR Ecrou à six pans METR Hexagon nut METR	230 	Gerade Einschraubverschraubung Union mâle Male adaptor union	243-251 	Gerade Schottverschraubung Union double traversée de cloison Panel mount union	264-267 
	SO 50006		SO 51121		SO 51521
Anschlussmutter Ecrou Union nut	231 	Thermofühlerverschraubung Union pour sondes thermocouple Temperature probe union	252-256 	Einstellnippel Adaptateur orientable mâle Adjustable male adaptor	268-269 
	SO 50020		SO 51124-D		SO 51600
Armaturenanschluss Ecrou et bague de raccordement Nut connection	232-234 	Gerade Aufschraubverschraubung Union femelle Female adaptor union	257 	Reduktions-Einstellverschraubung Raccord de réduction orientable Adjustable reduction union	270-271 
	SO 50021		SO 51221		SO 51821
Übergangsmuffe Adaptateur femelle Female adaptor	235 	Verbindungs-nippel Pièce folle Tube stub	258-259 	Winkelverschraubung Coude Elbow union	272-276 
	SO 50030		SO 51300		SO 52021
Übergangsnippel Adaptateur femelle - mâle Male adaptor	236-237 	Einstellbare Verschraubung Union orientable Adjustable union	260 	Winkel-Einschraubverschraubung Coude mâle Male adaptor elbow union	277-278 
	SO 50040		SO 51325		SO 52421

Seite/Page/Page

279-280
Einstellbare Winkelverschraubung
Coude orientable
Adjustable elbow union



SO 52621

281
Winkel-Schottverschraubung
Coude traversée de cloison
Panel mount elbow union



SO 52721

282
Schwenkverschraubung
Coude banjo
Single banjo



SO 52824

283-288
T-Verschraubung
Té égal
Tee union



SO 53021

289-292
Einstellbare T- und L-Verschraubung
Té et L orientable
Adjustable tee and L union



SO 53621

293
Kreuzverschraubung
Croix égale
Cross union



SO 54021

**Sonderausführungen auf Anfrage
Exécution en option sur demande
Optional services on request**



Spezialreinigung - entfettet
Traitement spécial - dégraissé
Special treatment - degreased



Spezialbehandlung für Einsatz mit Sauerstoff
Traitement spécial pour utilisation sous oxygène
Special treatment for use with oxygen



Spezialbehandlung - silikonfrei
Traitement spécial - sans silicone
Special treatment - silicone free



Vorbeschichtete Gewinde mit Loctite 5061
Filetages pré enduits avec Loctite 5061
Pre-coated threads with Loctite 5061

**Bestätigungen auf www.serto.com
Confirmations sur www.serto.com
Confirmations on www.serto.com**



Eigenschaften, Besonderheiten

- einfache, schnelle Montage
- korrosionsbeständig
- kompakte Baumassee
- grosse Sortimentsvielfalt
- viele Kombinationsmöglichkeiten

Funktionsprinzip

Siehe Kapitel i

Werkstoff

Edelstahl 1.4571 (≈ AISI 316 Ti),
Legierung X6CrNiMoTi 17-12-2,
DIN EN 10088-3

Betriebsdruck PN

Siehe Produkttabellen (4-fache Sicherheit)

Temperaturbereich

-196°C bis +500°C, bis +600°C auf Anfrage

Helium-Leckrate

10⁻⁸ mbar • l/s *

Vakuum

Bis 10⁻⁴ mbar, höhere Werte möglich

Anzuschliessende Rohre

Kunststoffrohre und nahtlose Präzisionsrohre aus Edelstahl (DIN EN 10216-5/EN ISO 1127) mit sauberer, glatter Oberfläche. Toleranz Aussendurchmesser ± 0.1 mm, Rohre Ø < 6 mm Toleranz ± 0.05 mm; Ausnahme: Kunststoffrohre. Siehe auch Kapitel i und Kapitel 19. Weitere Materialien auf Anfrage.

Abnahmeprüfzeugnis

Abnahmeprüfzeugnis 3.1 nach EN 10204 (kostenpflichtig)

Zulassungen

DNV GL, DVGW, SVGW, ABS
Weitere Informationen auf Anfrage.

Bestätigungen

FDA für FKM-O-Ringe

Einschraubzapfen, Gewinde

Rohrgewinde (Zoll) und metrisches Feingewinde DIN 3852, kegelig nach Form C, mit Dichtkante nach Form B. NPT-Gewinde nach ANSI B1.20.1.
Zum Abdichten der kegeligen Einschraubgewinde empfehlen wir Loctite® 5061.

Druckauswertungsgrad in % des PN

°C								
-196°	-110°	-60°	0°	300°	400°	450°	500°	600°
50 %	70 %		100 %		75 %	60 %	50 %	auf Anfrage sur demande on request

* bei fachgerechter Montage können Werte von 10⁻⁸ mbar • l/s erreicht werden; siehe Kapitel i:
- Montageanleitung
- Rohrempfehlungen

Propriétés, spécificités

- montage facile et rapide
- résistant à la corrosion
- dimensions compactes
- vaste gamme de produits
- multiples possibilités de combinaisons

Principe de fonctionnement

Voir chapitre i

Matériau

Acier inoxydable 1.4571 (≈ AISI 316 Ti),
avec l'alliage X6CrNiMoTi 17-12-2,
DIN EN 10088-3

Pression de service PN

Voir tableaux des produits (facteur de sécurité 4)

Plage de température admissible

-196°C à +500°C, jusqu'à +600°C sur demande

Débit de fuite avec hélium

10⁻⁸ mbar • l/s *

Vide

Jusqu'à 10⁻⁴ mbar, valeurs plus élevées possible

 Tubes à utiliser

Tubes en matière plastique et tous les tubes en acier inoxydable sans soudure (selon DIN EN 10216-5/EN ISO 1127), avec surface propre et lisse. Tolérance du diamètre extérieur de ± 0.1 mm, tubes Ø < 6 mm tolerance ± 0.05 mm; exception: tubes en plastique. Voir aussi chapitre i et chapitre 19. Autres matériaux sur demande.

Certificat de réception

Certificat de réception selon EN 10204 (payant)

Certifications

DNV GL, DVGW, SVGW, ABS
Autres informations sur demande.

Confirmations

FDA pour les joints toriques FKM

Embouts mâles, filetages

Filetage-gaz (BSP) et filetage métrique à pas fin DIN 3852; conique selon forme C; filetage d'étanchéité selon forme B. Filetage NPT selon ANSI B1.20.1.
Pour assurer l'étanchéité des filetages mâles coniques, nous recommandons Loctite® 5061.

Coefficient de pression de service admissible en % de PN
Characteristics, specialities

- easy and fast to install
- resistant to corrosion
- compact size
- extensive product range
- many combination possibilities

Operating principle

See chapter i

Material

Stainless steel 1.4571 (≈ AISI 316 Ti)
with alloy X6CrNiMoTi 17-12-2,
DIN EN 10088-3

Working pressure PN

See product tables (safety factor 4)

Temperature range

-196°C to +500°C, up to +600°C on request

Leak rate with helium

10⁻⁸ mbar • l/s *

Vacuum

Up to 10⁻⁴ mbar, higher values are possible

Tubes to use

Tubes of plastic and stainless steel seamless precision tubes (to DIN EN 10216-5/EN ISO 1127) with clean smooth surface. Tolerance of outside diameter ± 0.1 mm, tubes Ø < 6 mm tolerance ± 0.05 mm; exception: plastic tubes. See also chapter i and chapter 19. Further materials on request.

Inspection certificate

Inspection certificate 3.1 according to EN 10204 (with costs)

Approvals

DNV GL, DVGW, SVGW, ABS
Additional information on request.

Confirmations

FDA for FKM O-rings

Adaptor stem, male thread

British Standard Pipe (BSP) and metric fine thread DIN 3852; tapered form C; thread with edge seal form B. NPT-thread according to ANSI B1.20.1.
For sealing of the tapered male adaptor thread we recommend Loctite® 5061.

Pressure coefficient % of PN

* when professionally assembled values up to 10⁻⁸ mbar • l/s can be achieved; see chapter i:
- Installation instructions
- Recommendations for tubes

Klemmring

Bague de serrage

Compression ferrule

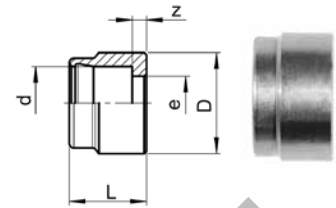

SO 50001

Type-d	Mat.-Nr.	bar	L	D	z	e	kg/100
Für metrische Rohre	Pour tubes métriques		For metric tubes				
SO 50001-2	056.0010.020	250	3.5	5.0	0.7	1.5	0.020
SO 50001-3	056.0010.030	250	4.5	5.0	0.9	2.5	0.030
SO 50001-4	056.0010.040	250	5.0	6.0	1.0	3.5	0.050
SO 50001-5	056.0010.050	250	5.5	6.8	1.1	4.0	0.050
SO 50001-6	056.0010.060	200	6.5	8.5	1.2	4.5	0.120
SO 50001-8	056.0010.080	200	7.0	10.5	1.2	6.5	0.170
SO 50001-10	056.0010.100	160	7.8	12.7	1.2	8.5	0.260
SO 50001-12	056.0010.120	160	8.8	14.7	1.2	10.0	0.330
SO 50001-15	056.0010.150	100	10.0	18.0	1.4	13.0	0.510
SO 50001-18	056.0010.180	100	12.0	22.0	1.4	16.0	1.030
SO 50001-22	056.0010.220	64	13.5	26.0	1.4	20.0	1.260
SO 50001-28	056.0010.280	40	15.4	32.5	2.0	24.0	2.440

Für Zollrohre	Pour tubes pouces		For inch tubes				
SO 50001-3,2	056.0010.032	250	4.5	5.0	0.9	2.5	0.030
SO 50001-6,35	056.0010.063	200	6.5	8.5	1.2	4.5	0.110
SO 50001-7,94	056.0010.079	200	7.0	10.5	1.2	6.5	0.180
SO 50001-9,52	056.0010.095	160	7.8	12.7	1.2	8.0	0.300
SO 50001-12,7	056.0010.127	160	10.5	18.0	1.5	11.0	0.740

Umrechnung für "d" bei Zollrohren:

3,2 = 1/8
 6,35 = 1/4
 7,94 = 5/16
 9,52 = 3/8
 12,7 = 1/2

Conversion de "d" pour tubes en pouces:

3,2 = 1/8
 6,35 = 1/4
 7,94 = 5/16
 9,52 = 3/8
 12,7 = 1/2

Conversion for "d" for inch tubes:

3,2 = 1/8
 6,35 = 1/4
 7,94 = 5/16
 9,52 = 3/8
 12,7 = 1/2

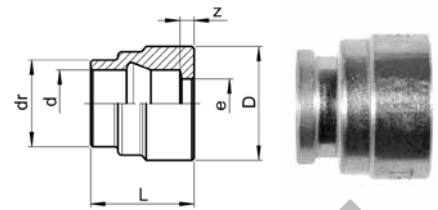
Klemmring reduziert
Bague de serrage de réduction
Reduction compression ferrule

SO 50001 RED

Type-dr-d	Mat.-Nr.	bar	L	D	z	e	kg/100
Für metrische Rohre	Pour tubes métriques		For metric tubes				
SO 50001-4-2	056.0014.030	250	7.0	6.0	0.9	1.5	0.090
SO 50001-5-3	056.0014.060	250	6.8	6.5	0.9	2.5	0.120
SO 50001-6-4	056.0014.110	200	8.5	8.5	1.1	3.5	0.220
SO 50001-6-5	056.0014.117	200	8.7	8.5	1.1	4.0	0.170
SO 50001-8-6	056.0014.140	200	9.5	10.5	1.3	4.5	0.320
SO 50001-10-8	056.0014.190	160	11.5	12.7	1.3	6.5	0.450
SO 50001-12-10	056.0014.240	160	12.5	14.7	1.2	8.5	0.590
SO 50001-15-12	056.0014.420	100	15.0	18.0	1.2	10.0	1.130
SO 50001-15-14	056.0014.440	100	15.0	18.0	1.4	12.0	0.730
SO 50001-18-15	056.0014.610	100	16.7	22.0	1.4	13.0	3.010
SO 50001-18-16	056.0014.620	100	16.7	22.0	1.4	14.0	1.490
SO 50001-22-18	056.0014.755	64	20.0	26.0	1.4	16.0	3.010

Für Zollrohre	Pour tubes pouces		For inch tubes				
SO 50001-3-1,6	056.0014.015	250	6.2	5.0	0.8	1.0	0.050
SO 50001-5-3,2	056.0014.062	250	6.8	6.5	0.9	2.5	0.110
SO 50001-8-6,35	056.0014.143	200	9.5	10.5	1.3	4.5	0.300
SO 50001-10-7,94	056.0014.187	160	11.5	12.7	1.3	6.5	0.440
SO 50001-15-12,7	056.0014.427	100	15.0	18.0	1.4	11.0	0.990
SO 50001-15-13,5	056.0014.435	100	15.0	18.0	1.4	12.0	0.860
SO 50001-18-15,88	056.0014.618	100	16.7	22.0	1.4	14.0	1.610
SO 50001-18-17,2	056.0014.632	100	16.7	22.0	1.4	15.0	1.140
SO 50001-22-19,05	056.0014.760	64	20.0	26.0	1.4	16.0	2.450
SO 50001-22-21,3	056.0014.785	64	20.0	26.0	1.4	19.5	1.690

Umrechnung für "d" bei Zollrohren:

1,6 = 1/16
 3,2 = 1/8
 6,35 = 1/4
 7,94 = 5/16
 12,7 = 1/2
 13,5 = 17/32
 15,88 = 5/8
 17,2 = 11/16
 19,05 = 3/4
 21,3 = 27/32

Conversion de "d" pour tubes en pouces:

1,6 = 1/16
 3,2 = 1/8
 6,35 = 1/4
 7,94 = 5/16
 12,7 = 1/2
 13,5 = 17/32
 15,88 = 5/8
 17,2 = 11/16
 19,05 = 3/4
 21,3 = 27/32

Conversion for "d" for inch tubes:

1,6 = 1/16
 3,2 = 1/8
 6,35 = 1/4
 7,94 = 5/16
 12,7 = 1/2
 13,5 = 17/32
 15,88 = 5/8
 17,2 = 11/16
 19,05 = 3/4
 21,3 = 27/32

Fortsetzung nächste Seite

Suite à la prochaine page

Continued on next page

Anwendungsbeispiele:

Einstufige Reduktionen von Rohranschlüssen sind auf einfachste Art durch Auswechseln der normalen gegen die reduzierten Klemmringe möglich.

Beispiel:

Reduktion eines Rohranschlusses 15 mm auf 12 mm:
Klemmring SO 50001-15 austauschen gegen SO 50001-15-12 RED. Anschlussmutter SO 50020-15 bleibt.

Exemples d'utilisation:

SO 50001 RED

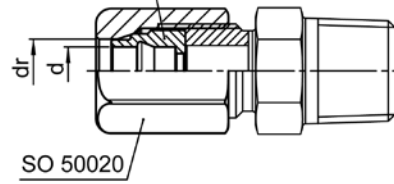

SO 50020

Les réductions à une étape des raccords sont disponibles de manière simple en remplaçant la normale par rapport aux bagues de serrage réduites.

Exemple:

Réduction d'un raccord 15 mm sur 12 mm:
Bague de serrage SO 50001-15 en échange de SO 50001-15-12 RED. L'écrou de raccordement SO 50020-15 reste.

Sample combinations:

Single stage reductions for tube connections can be simply achieved by replacing the normal compression ferrule with reduced compression ferrules.

Example:

Reduction of a tube connection 15 mm to 12 mm:
Replace compression ferrule SO 50001-15 with SO 50001-15-12 RED. The union nut SO 50020-15 remains.

KONVARI

Klemmring

für Thermofühler

Bague de serrage

pour sondes

Compression ferrule

for temperature probes

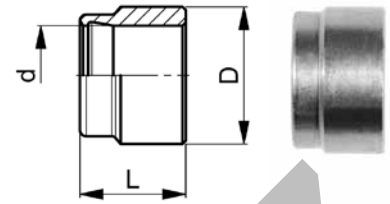

SO 50001 D

Type -d	Mat.-Nr.	bar	L	D	kg/100
SO 50001-2 D	056.0012.020	250	3.5	5.0	0.020
SO 50001-2-1 D	056.0012.008	250	4.5	5.0	0.030
SO 50001-2-1,5 D	056.0012.013	250	4.5	5.0	0.020
SO 50001-3 D	056.0012.030	250	4.5	5.0	0.030
SO 50001-3-1,6 D	056.0012.015	250	6.0	5.0	0.050
SO 50001-3-2,5 D	056.0012.043	250	4.5	5.0	0.040
SO 50001-4 D	056.0012.040	250	5.0	6.0	0.050
SO 50001-5-3 D	056.0012.061	250	6.8	6.5	0.110
SO 50001-5-3,2 D	056.0012.062	200	6.8	6.5	0.110
SO 50001-5-3,5 D	056.0012.068	200	6.8	6.5	0.100
SO 50001-6 D	056.0012.060	200	6.5	8.5	0.110
SO 50001-6-5 D	056.0012.117	200	8.7	8.5	0.170
SO 50001-8 D	056.0012.080	200	7.0	10.5	0.150
SO 50001-8-6 D	056.0012.140	200	9.5	10.5	0.310
SO 50001-10 D	056.0012.100	160	8.0	12.5	0.220
SO 50001-10-8 D	056.0012.190	160	11.5	12.5	0.430
SO 50001-12 D	056.0012.120	160	9.0	14.5	0.290
SO 50001-12-10 D	056.0012.240	160	12.5	14.5	0.560
SO 50001-15 D	056.0012.150	100	10.0	18.0	0.460
SO 50001-15-12 D	056.0012.420	100	15.0	18.0	1.100
SO 50001-18 D	056.0012.180	100	12.0	22.0	0.890
SO 50001-22 D	056.0012.220	64	13.5	26.0	1.160

Anwendungsbeispiele:

Exemples d'utilisation:

Sample combinations:

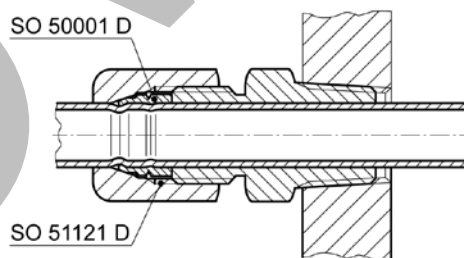
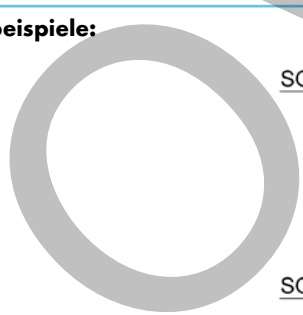

Messleitungen können durch den Klemmring ohne Innenbund durchgesteckt werden. Durchgangsverschraubungen für Messleitungen sind auch erhältlich. Bei Bestellung ist die Typennummer der Standard Verschraubung zusätzlich mit "D" zu ergänzen, z.B. SO 51121-8-1/4 D.

Les lignes de mesure peuvent être insérées à travers la bague de serrage sans collet intérieur. Des raccords pour conduites de mesure sont également disponibles. Lors de la commande, le numéro de type du raccord standard doit être complété avec la lettre "D", par exemple SO 51121-8-1/4 D.

Measuring lines can be pushed through the compression ferrule without collar. Unions for gauge lines are also available. For ordering, the type number of the standard union must be supplemented with "D", e.g. SO 51121-8-1/4 D.

Klemmring

für Manometeranschluss

Bague de serrage

pour écrou de manomètre

Compression ferrule

for pressure gauge connection

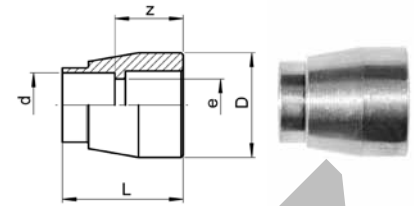

SO 50001 MAN

Type -d	Mat.-Nr.	bar	L	D	z	e	kg/100
SO 50001-6 MAN	056.0011.110	125	11.5	10.0	6.5	5.0	0.320
SO 50001-8 MAN	056.0011.185	125	11.5	11.0	5.5	6.5	0.410

Beide Dimensionen sind für 1/4" und 1/2" Gewinde geeignet.

Les deux dimensions sont utilisables pour les filetages 1/4" et 1/2".

Both dimensions are suitable for 1/4" and 1/2" threads.

Diese Klemmringe "SO 50001 MAN" dürfen nur mit der Anschlussmutter für Manometer verwendet werden, deren Bestellnummer "MAN" enthält.

Les bagues de serrage "SO 50001 MAN" doivent être utilisées uniquement avec les écrous pour manomètre portant la désignation "MAN".

These compression ferrules "SO 50001 MAN" must only be used with the union nut for pressure gauges of which the order number contains "MAN".

Für alle anderen Manometeranschlüsse wird der Klemmring SO 50001 verwendet.

Pour d'autres dimensions, utiliser la bague de serrage SO 50001.

For all other pressure gauge connections the compression ferrule SO 50001 is to be used.

Klemmring

mit integrierter Stützhülse

Bague de serrage

avec douille d'appui intégrée

Compression ferrule

with integrated stiffener sleeve

SO 50001 FIX

Type -d-d1	Mat.-Nr.	bar	L	D	s	z	e	kg/100
SO 50001-6-4 FIX	056.0015.110	200	11.2	8.5	0.20	1.2	4.5	0.140
SO 50001-8-6 FIX	056.0015.140	200	13.2	10.5	0.25	1.2	6.5	0.220
SO 50001-10-8 FIX	056.0015.190	160	16.2	12.7	0.30	1.2	8.5	0.340
SO 50001-12-10 FIX	056.0015.240	160	19.2	14.7	0.25	1.2	10.0	0.520

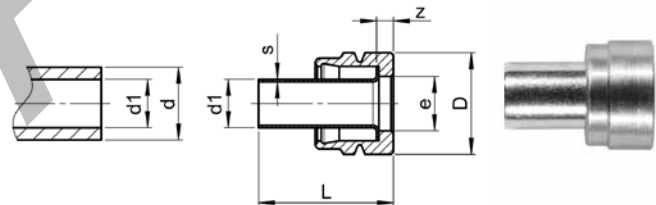

d=Rohraussen-ø
d1=Rohrinnen-ø
s=Rohrwandstärke

d=ø extérieur du tube
d1=ø intérieur de tube
s=épaisseur de la paroi du tube

d=tube outside diameter
d1=tube inside diameter
s=tube wall thickness

Abschlusszapfen

Bouchon d'arrêt

Plug

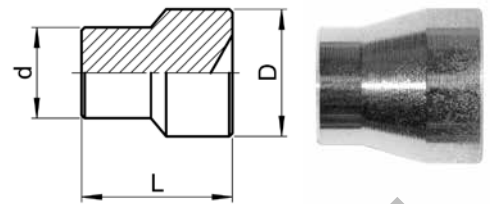

SO 50002

Type -d	Mat.-Nr.	L	D	kg/100
Für metrische Rohre	Pour tubes métriques		For metric tubes	
SO 50002-2	056.0020.020	5.5	3.6	0.030
SO 50002-3	056.0020.030	7.0	4.8	0.070
SO 50002-4	056.0020.040	8.0	6.0	0.130
SO 50002-5	056.0020.050	8.5	6.4	0.170
SO 50002-6	056.0020.060	9.5	8.3	0.310
SO 50002-8	056.0020.080	10.0	10.3	0.530
SO 50002-10	056.0020.100	13.0	12.3	0.960
SO 50002-12	056.0020.120	14.0	13.6	1.400
SO 50002-15	056.0020.150	16.5	16.6	2.460
SO 50002-18	056.0020.180	19.0	20.5	4.290
SO 50002-22	056.0020.220	22.0	24.5	7.100
SO 50002-28	056.0020.280	23.0	30.5	11.570

Für Zollrohre	Pour tubes pouces		For inch tubes	
SO 50002-6,35	056.0020.063	9.5	8.3	0.310
SO 50002-7,94	056.0020.079	10.0	10.3	0.530
SO 50002-9,52	056.0020.095	13.0	12.3	0.950
SO 50002-12,7	056.0020.127	15.5	16.6	1.900

Umrechnung für "d" bei Zollrohren:

6,35 = 1/4
 7,94 = 5/16
 9,52 = 3/8
 12,7 = 1/2

Conversion de "d" pour tubes en pouces:

6,35 = 1/4
 7,94 = 5/16
 9,52 = 3/8
 12,7 = 1/2

Conversion for "d" for inch tubes:

6,35 = 1/4
 7,94 = 5/16
 9,52 = 3/8
 12,7 = 1/2

Anwendungsbeispiele:

Der Abschlusszapfen lässt sich in jede Verschraubung anstelle eines Klemmringes der gleichen Grösse einsetzen. Wird ein reduzierter Klemmring durch einen Abschlusszapfen ersetzt, so muss immer von der Grösse der Anschlussmutter ausgegangen werden.

Montagehinweis: Anschlussmutter mit 1/4 Umdrehung anziehen.

Exemples d'utilisation:

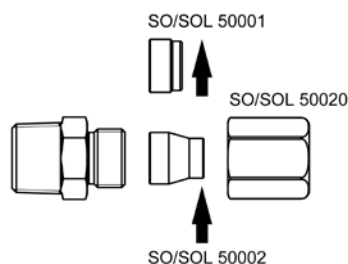

Le bouchon d'arrêt s'insère dans tout raccord au lieu d'une bague de serrage de la même taille. Si une bague de serrage de réduction est remplacée par un bouchon d'arrêt, la taille de l'écrou de raccordement doit toujours être prise en compte.

Note d'installation: Serrez l'écrou d'accouplement de 1/4 de tour.

Sample combinations:

The plug can be inserted into all unions instead of a compression ferrule of the same size. If a reduction compression ferrule is replaced by a plug, the size of the union nut must be used as a basis.

Assembly information: Tighten the union nut with 1/4 turn.

Stützhülse

zur Rohrverstärkung

Douille d'appui

pour renforcer les tubes

Stiffener sleeve

to reinforce tubes

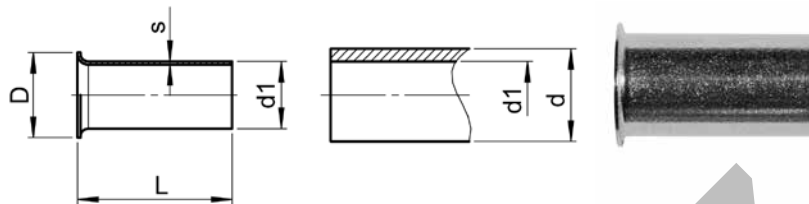

SO 50003

Type - d - d1	Mat.-Nr.	L	D	s	kg/100
Für metrische Rohre	Pour tubes métriques			For metric tubes	
SO 50003-3-2	056.003 1.020	6.0	2.8	0.20	0.010
SO 50003-4-2	056.003 1.030	8.0	3.8	0.20	0.010
SO 50003-4-2,5	056.003 1.035	8.0	3.8	0.20	0.010
SO 50003-4-3	056.003 1.040	8.0	3.8	0.20	0.010
SO 50003-5-3	056.003 1.060	9.0	4.5	0.20	0.010
SO 50003-5-4	056.003 1.080	9.0	4.5	0.20	0.010
SO 50003-6-3	056.003 1.100	10.0	5.0	0.20	0.020
SO 50003-6-4	056.003 1.110	10.0	5.5	0.20	0.020
SO 50003-6-4,5	056.003 1.114	10.0	5.5	0.20	0.020
SO 50003-6-5	056.003 1.117	10.0	5.5	0.25	0.030
SO 50003-8-5	056.003 1.136	12.0	7.5	0.25	0.040
SO 50003-8-6	056.003 1.140	12.0	7.5	0.25	0.040
SO 50003-8-7	056.003 1.150	12.0	7.5	0.30	0.060
SO 50003-10-7	056.003 1.180	15.0	9.5	0.30	0.080
SO 50003-10-8	056.003 1.190	15.0	9.5	0.30	0.090
SO 50003-10-9	056.003 1.195	15.0	9.5	0.40	0.120
SO 50003-12-9	056.003 1.230	18.0	11.5	0.40	0.160
SO 50003-12-10	056.003 1.240	18.0	11.5	0.40	0.160
SO 50003-12-10,4	056.003 1.254	18.0	11.5	0.40	0.170
SO 50003-14-12	056.003 1.340	20.0	13.5	0.50	0.290
SO 50003-15-12	056.003 1.420	20.0	14.5	0.50	0.290
SO 50003-15-13	056.003 1.430	20.0	14.5	0.50	0.300
SO 50003-16-14	056.003 1.500	22.0	15.5	0.60	0.430
SO 50003-18-14	056.003 1.600	24.0	17.5	0.60	0.500
SO 50003-18-15	056.003 1.610	24.0	17.5	0.60	0.520
SO 50003-18-16	056.003 1.620	24.0	17.5	0.60	0.540
SO 50003-22-19	056.003 1.760	28.0	21.5	0.60	0.780
SO 50003-22-20	056.003 1.775	28.0	21.5	0.60	0.820
SO 50003-28-25	056.003 1.910	34.0	27.5	0.60	1.170
Für Zollrohre	Pour tubes pouces			For inch tubes	
SO 50003-9,52-6,22	056.003 1.160	15.0	9.0	0.30	0.076

 Umrechnung für "d" bei Zollrohren:
 $9,52 = 3/8$

 Conversion de "d" pour tubes en pouces:
 $9,52 = 3/8$

 Conversion for "d" for inch tubes:
 $9,52 = 3/8$

Werkstoff: Inox 1.4404

Matériau: Inox 1.4404

Material: Inox 1.4404

Verstärken:

 Kunststoffrohre und dünnwandige
 Edelstahlrohre sind durch Stützhülsen zu ver-
 stärken.

 Genaue Angaben über das Verstärken siehe
 Kapitel i.

 Hilfswerkzeuge zum Entgraten und Kalibrieren
 der Rohre siehe Kapitel 21.

Renforcement:

 Tubes en plastique et tubes en acier inoxydable
 à paroi mince doivent être renforcés à l'aide de
 douilles d'appui.

 Pour des indications concernant le renforcement
 voir chapitre i.

 Pour des outils pour l'ébarbage et le calibrage
 du tube voir chapitre 21.

Reinforcement:

 Plastic tubes and thin walled stainless steel
 tubes are to be reinforced with stiffener sleeves.
 Details concerning stiffening can be found in
 chapter i.

 For useful tools for deburring and calibrating
 tubes see chapter 21.

 d=Rohraussen-ø
 d1=Rohrinnen-ø
 s=Rohrwandstärke

 d=ø extérieur du tube
 d1=ø intérieur de tube
 s=épaisseur de la paroi du tube

 d=tube outside diameter
 d1=tube inside diameter
 s=tube wall thickness

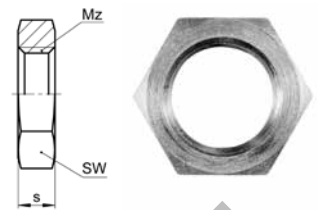
Sechskantmutter METR
Ecrou à six pans METR
Hexagon nut METR

SO 50006 METR

Type -Mz	Mat.-Nr.	SW	s	kg/100
Mz=metrisches Gewinde (zylindrisch)	Mz=Filetage métrique (cylindrique)	Mz=Metric thread (parallel)		
SO 50006-M6x0,75	056.0063.098	10	3.50	0.160
SO 50006-M8x1	056.0063.120	12	3.50	0.210
SO 50006-M10x1	056.0063.150	14	5.00	0.350
SO 50006-M12x1	056.0063.190	17	6.00	0.660
SO 50006-M14x1	056.0063.220	19	6.00	0.760
SO 50006-M16x1	056.0063.260	22	6.00	1.030
SO 50006-M20x1,5	056.0063.345	27	6.00	1.480
SO 50006-M24x1,5	056.0063.405	30	7.00	1.850
SO 50006-M28x1,5	056.0063.445	36	8.00	3.330
SO 50006-M36x2	056.0063.560	41	10.00	3.670

 Sechskantmutter für SO 51521, SO 51524
und SO 52721

 Ecrou à six pans pour SO 51521, SO 51524
et SO 52721

 Hexagon nut for SO 51521, SO 51524 and
SO 52721

Anschlussmutter

Ecrou

Union nut

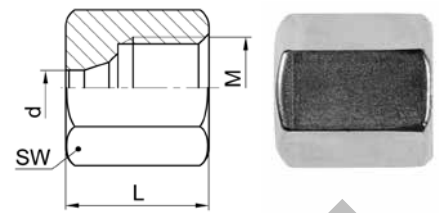

SO 50020

Type -d	Mat.-Nr.	bar	M	SW	L	kg/100
Für metrische Rohre	Pour tubes métriques		For metric tubes			
SO 50020-2	056.0200.020	250	6x0.75	8	8.5	0.240
SO 50020-3	056.0200.030	250	6x0.75	8	10.0	0.280
SO 50020-4	056.0200.040	250	8x1.0	10	13.0	0.510
SO 50020-5	056.0200.050	250	8x1.0	10	13.5	0.500
SO 50020-6	056.0200.060	200	10x1.0	12	15.5	0.820
SO 50020-8	056.0200.080	200	12x1.0	14	17.0	1.010
SO 50020-10	056.0200.100	160	14x1.0	17	19.5	1.860
SO 50020-12	056.0200.120	160	16x1.0	19	20.5	2.300
SO 50020-15	056.0200.150	100	20x1.5	24	24.0	4.430
SO 50020-18	056.0200.180	100	24x1.5	30	25.0	8.020
SO 50020-22	056.0200.220	64	28x1.5	32	28.0	8.310
SO 50020-28	056.0200.280	40	36x2.0	41	31.5	15.470

Type -d	Mat.-Nr.	bar	M	SW	L	kg/100
Für Zollrohre	Pour tubes pouces		For inch tubes			
SO 50020-3,2	056.0200.032	250	6x0.75	8	10.0	0.280
SO 50020-6,35	056.0200.063	200	10x1.0	12	15.5	0.736
SO 50020-7,94	056.0200.079	200	12x1.0	14	16.5	1.010
SO 50020-9,52	056.0200.095	160	14x1.0	17	18.5	1.880
SO 50020-12,7	056.0200.127	160	20x1.5	24	23.5	4.940

Umrechnung für "d" bei Zollrohren:

3,2 = 1/8
 6,35 = 1/4
 7,94 = 5/16
 9,52 = 3/8
 12,7 = 1/2

Conversion de "d" pour tubes en pouces:

3,2 = 1/8
 6,35 = 1/4
 7,94 = 5/16
 9,52 = 3/8
 12,7 = 1/2

Conversion for "d" for inch tubes:

3,2 = 1/8
 6,35 = 1/4
 7,94 = 5/16
 9,52 = 3/8
 12,7 = 1/2

Anschlussmutter MAN

Ecrou MAN

Union nut MAN

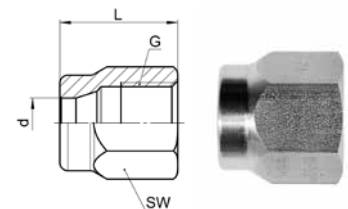

SO 50020 MAN

Type -d-G	Mat.-Nr.	bar	SW	L	kg/100
G=Rohrgewinde (zylindrisch)	G=Filetage-gaz BSP (cylindrique)		G=BSP thread (parallel)		
SO 50020-6-1/4 MAN	056.0201.110	200	17	20.0	2.430
SO 50020-6-1/2 MAN	056.0201.125	200	24	28.0	5.190
SO 50020-8-1/4 MAN	056.0201.170	200	17	24.0	2.470
SO 50020-8-1/2 MAN	056.0201.185	200	24	29.0	5.010
SO 50020-10-1/2 MAN	056.0201.285	160	24	25.5	4.340
SO 50020-12-1/2 MAN	056.0201.400	160	24	28.0	4.760

Armaturenanschluss

Ecrou et bague de raccordement

Nut connection

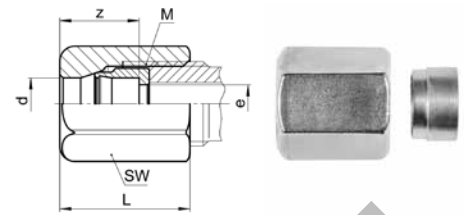

SO 50021

Type -d	Mat.-Nr.	bar	M	SW	L	z	e	kg/100
Für metrische Rohre	Pour tubes métriques			For metric tubes				
SO 50021-2	056.0210.020	250	6x0.75	8	8.5	3.5	1.5	0.260
SO 50021-3	056.0210.030	250	6x0.75	8	10.0	5.0	2.5	0.310
SO 50021-4	056.0210.040	250	8x1.0	10	13.0	5.5	3.5	0.560
SO 50021-5	056.0210.050	250	8x1.0	10	13.5	6.0	4.0	0.550
SO 50021-6	056.0210.060	200	10x1.0	12	15.5	8.0	4.5	0.860
SO 50021-8	056.0210.080	200	12x1.0	14	17.0	8.5	6.5	1.190
SO 50021-10	056.0210.100	160	14x1.0	17	19.5	11.5	8.5	2.120
SO 50021-12	056.0210.120	160	16x1.0	19	20.5	12.0	10.0	2.620
SO 50021-15	056.0210.150	100	20x1.5	24	24.0	14.0	13.0	4.950
SO 50021-18	056.0210.180	100	24x1.5	30	25.0	15.5	16.0	9.050
SO 50021-22	056.0210.220	64	28x1.5	32	28.0	19.0	20.0	9.610
SO 50021-28	056.0210.280	40	36x2.0	41	31.5	19.5	24.0	17.890

Für Zollrohre	Pour tubes pouces			For inch tubes				
SO 50021-3,2	056.0210.032	250	6x0.75	8	10.0	5.0	2.5	0.310
SO 50021-6,35	056.0210.063	200	10x1.0	12	15.5	8.0	4.5	0.840
SO 50021-7,94	056.0210.079	200	12x1.0	14	16.5	8.5	6.5	1.050
SO 50021-9,52	056.0210.095	160	14x1.0	17	18.5	11.5	8.0	2.180
SO 50021-12,7	056.0210.127	160	20x1.5	24	23.5	13.5	11.0	5.680

Umrechnung für "d" bei Zollrohren:

3,2 = 1/8
 6,35 = 1/4
 7,94 = 5/16
 9,52 = 3/8
 12,7 = 1/2

Conversion de "d" pour tubes en pouces:

3,2 = 1/8
 6,35 = 1/4
 7,94 = 5/16
 9,52 = 3/8
 12,7 = 1/2

Conversion for "d" for inch tubes:

3,2 = 1/8
 6,35 = 1/4
 7,94 = 5/16
 9,52 = 3/8
 12,7 = 1/2

Gewindezapfen für SERTO-Anschlüsse siehe Kapitel i.

Embout fileté pour écrous de raccordement SERTO voir chapitre i.

Threaded stem for SERTO connections see chapter i.

Armaturenanschluss reduziert Ecrou et bague de raccordement réduite Reduction nut connection

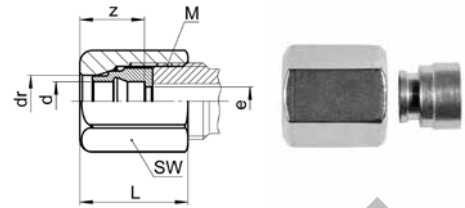

SO 50021 RED

Type-dr-d	Mat.-Nr.	bar	M	SW	L	z	e	kg/100
Für metrische Rohre	Pour tubes métriques			For metric tubes				
SO 50021-5-3	056.0214.060	250	8x1.0	10	13.5	6.0	2.5	0.630
SO 50021-6-4	056.0214.110	200	10x1.0	12	15.5	8.0	3.5	0.970
SO 50021-6-5	056.0214.117	200	10x1.0	12	15.5	8.0	4.0	0.910
SO 50021-8-6	056.0214.140	200	12x1.0	14	17.0	8.5	4.5	1.330
SO 50021-10-8	056.0214.190	160	14x1.0	17	19.5	11.5	6.5	2.310
SO 50021-12-10	056.0214.240	160	16x1.0	19	20.5	12.0	8.5	2.890
SO 50021-15-12	056.0214.420	100	20x1.5	24	24.0	14.0	10.0	5.560
SO 50021-15-14	056.0214.440	100	20x1.5	24	24.0	14.0	12.0	5.160
SO 50021-18-15	056.0214.610	100	24x1.5	30	25.0	15.5	13.0	9.780
SO 50021-18-16	056.0214.620	100	24x1.5	30	25.0	15.5	14.0	9.440
SO 50021-22-18	056.0214.755	64	28x1.5	32	28.0	19.0	16.0	11.320

Für Zollrohre	Pour tubes pouces			For inch tubes				
SO 50021-3-1,6	056.0214.015	250	6x0.75	8	10.0	5.0	1.0	0.330
SO 50021-5-3,2	056.0214.062	250	8x1.0	10	13.5	6.0	2.5	0.620
SO 50021-8-6,35	056.0214.143	200	12x1.0	14	17.0	8.5	4.5	1.310
SO 50021-10-7,94	056.0214.187	160	14x1.0	17	19.5	11.5	6.5	2.310
SO 50021-15-12,7	056.0214.427	100	20x1.5	24	24.0	14.0	11.0	5.440
SO 50021-15-13,5	056.0214.435	100	20x1.5	24	24.0	14.0	12.0	5.310
SO 50021-18-15,88	056.0214.618	100	24x1.5	30	25.0	15.5	14.0	9.490
SO 50021-18-17,2	056.0214.632	100	24x1.5	30	25.0	15.5	15.0	9.100
SO 50021-22-21,3	056.0214.785	64	28x1.5	32	28.0	19.0	19.5	9.990

Umrechnung für "d" bei Zollrohren:

1,6	=	1/16
3,2	=	1/8
6,35	=	1/4
7,94	=	5/16
12,7	=	1/2
13,5	=	17/32
15,88	=	5/8
17,2	=	11/16
21,3	=	27/32

Conversion de "d" pour tubes en pouces:

1,6	=	1/16
3,2	=	1/8
6,35	=	1/4
7,94	=	5/16
12,7	=	1/2
13,5	=	17/32
15,88	=	5/8
17,2	=	11/16
21,3	=	27/32

Conversion for "d" for inch tubes:

1,6	=	1/16
3,2	=	1/8
6,35	=	1/4
7,94	=	5/16
12,7	=	1/2
13,5	=	17/32
15,88	=	5/8
17,2	=	11/16
21,3	=	27/32

Anwendungsbeispiele:

Mit diesem Armaturenanschluss können einstufige Reduktionen vorgenommen werden. Gewindezapfen für SERTO-Anschlüsse siehe Kapitel i.

Exemples d'utilisation:

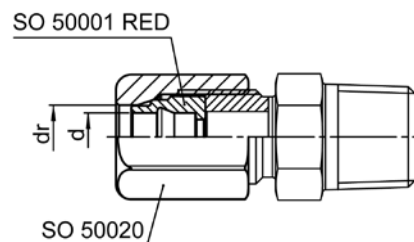

Avec cet écrou de raccordement, les réductions à une étape peuvent être faites. Embout fileté pour écrous de raccordement SERTO voir chapitre i.

Sample combinations:

Single stage reductions can be made with this nut connection. Threaded stem for SERTO connections see chapter i.

d=Rohrassens-ø
dr=Grösse der Anschlussmutter
e=kleinste Bohrung

d=ø extérieur du tube
dr=dimension de l'écrou
e=ø min. de passage

d=tube outside diameter
dr=size of the union nut
e=minimum bore

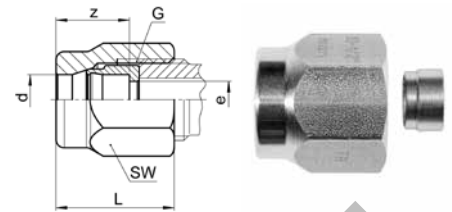
Manometeranschluss
Ecrou de manomètre
Nut connection for pressure gauge

SO 50021 MAN

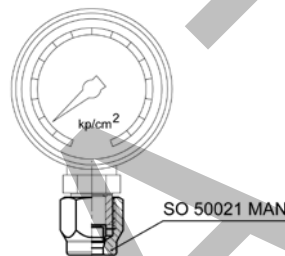
Type -d-G	Mat.-Nr.	bar	SW	L	z	e	kg/100
G=Rohrgewinde (zylindrisch)							
		G=Filetage-gaz BSP (cylindrique)				G=BSP thread (parallel)	
SO 50021-6-¼ MAN	056.0211.110	200	17	23.0	8.5	5.0	2.740
SO 50021-6-½ MAN	056.0211.125	200	24	28.0	9.0	5.0	5.500
SO 50021-8-¼ MAN	056.0211.170	200	17	24.0	10.5	6.5	2.880
SO 50021-8-½ MAN	056.0211.185	200	24	29.0	10.0	6.5	5.420
SO 50021-10-½ MAN	056.0211.285	160	24	25.5	12.0	8.5	4.750
SO 50021-12-½ MAN	056.0211.400	160	24	28.0	13.5	10.0	5.090

Anwendungsbeispiele:
Exemples d'utilisation:
Sample combinations:

Übergangsmuffe

Adaptateur femelle

Female adaptor

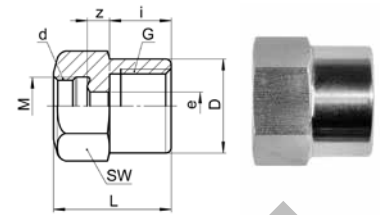

SO 50030

Type -d-G	Mat.-Nr.	bar	M	SW	L	D	i	z	e	kg/100
G=Rohrgewinde (zylindrisch)	G=Filetage-gaz BSP (cylindrique)		G=BSP thread (parallel)							
SO 50030-6-1/8	056.0301.100	200	10x1.0	14	20.0	13.8	10.0	4.0	5.0	1.500
SO 50030-6-1/4	056.0301.110	200	10x1.0	17	22.0	16.8	13.0	4.0	5.0	2.310
SO 50030-6-3/8	056.0301.120	200	10x1.0	22	22.0	21.8	13.0	4.0	5.0	4.480
SO 50030-6-1/2	056.0301.125	200	10x1.0	27	24.0	26.8	15.0	4.0	5.0	7.260
SO 50030-8-1/8	056.0301.160	200	12x1.0	17	21.0	16.8	10.0	4.0	6.5	2.610
SO 50030-8-1/4	056.0301.170	200	12x1.0	17	23.0	16.8	13.0	5.0	6.5	2.360
SO 50030-8-3/8	056.0301.180	200	12x1.0	22	23.0	21.8	13.0	4.0	6.5	4.450
SO 50030-8-1/2	056.0301.185	200	12x1.0	27	25.0	26.8	15.0	4.0	6.5	7.290
SO 50030-10-1/4	056.0301.270	160	14x1.0	17	24.0	16.8	13.0	4.0	8.5	1.870
SO 50030-10-3/8	056.0301.280	160	14x1.0	22	24.0	21.8	13.0	4.0	8.5	4.150
SO 50030-10-1/2	056.0301.285	160	14x1.0	27	26.0	26.8	15.0	4.0	8.5	7.080
SO 50030-12-1/4	056.0301.380	160	16x1.0	19	24.0	18.8	13.0	4.0	8.5	2.670
SO 50030-12-3/8	056.0301.390	160	16x1.0	22	24.0	21.8	13.0	4.0	10.0	3.750
SO 50030-12-1/2	056.0301.400	160	16x1.0	27	26.0	26.8	15.0	4.0	10.0	6.790
SO 50030-15-1/4	056.0301.528	100	20x1.5	24	21.0	20.0	13.0	4.0	11.5	3.500
SO 50030-15-3/8	056.0301.532	100	20x1.5	24	25.0	23.8	13.0	5.0	13.0	4.220
SO 50030-15-1/2	056.0301.534	100	20x1.5	27	28.0	26.8	15.0	5.0	13.0	6.580
SO 50030-15-3/4	056.0301.536	100	20x1.5	32	30.0	31.8	17.0	5.0	13.0	10.320
SO 50030-18-1/2	056.0301.646	100	24x1.5	30	28.0	29.8	15.0	6.0	15.0	9.060

Anwendungsbeispiele:

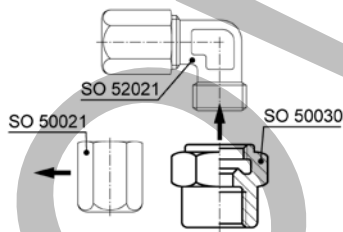

Die Übergangsmuffe kann auf jedes SERTO-Formteil mit dem passenden zylindrischen Gewinde geschraubt werden und muss mit 1/4 Umdrehung angezogen werden.

Dichtungsprinzip: Bei der Montage drückt sich die Dichtkante des Übergangsstückes in das SERTO-Formteil ein, dadurch entsteht eine einwandfreie Dichtung.

Wir empfehlen, das Gewinde mit einem geeigneten Flüssigklebstoff gegen unbeabsichtigtes Lösen zu sichern.

Exemples d'utilisation:

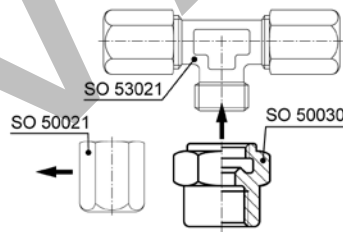

L'adaptateur femelle peut être vissé à toute pièce moulée SERTO avec le filetage cylindrique approprié et doit être serré de 1/4 de tour.

Principe d'étanchéité: Lors de l'assemblage, l'arête d'étanchéité de l'adaptateur appuie sur la pièce moulée SERTO, créant ainsi une étanchéité parfaite.

Nous recommandons de fixer le filetage avec une colle liquide appropriée pour empêcher le desserrage involontaire.

Sample combinations:

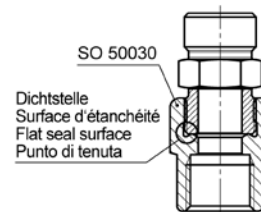

The female adaptor can be screwed onto all SERTO moulded parts with a matching cylindrical thread and must be tightened with 1/4 turn.

Sealing principle: During assembly, the sealing edge of the female adaptor presses into the SERTO moulded part to produce a perfect seal.

We recommend that the thread is secured against accidental unscrewing by means of a suitable liquid adhesive.

Übergangsnippel

Adaptateur femelle - mâle

Male adaptor

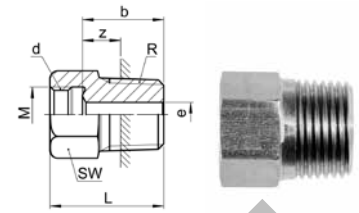

SO 50040

Type -d -R	Mat.-Nr.	bar	M	SW	L	b	z	e	kg/100
R=Rohrgewinde (kegelig)	R=Filetage-gaz BSP (conique)	R=BSP thread (tapered)							
SO 50040-5-1/8	056.0401.082	250	8x1.0	10	17.0	11.0	7.0	3.5	0.710
SO 50040-6-1/8	056.0401.100	200	10x1.0	12	17.0	11.0	7.0	4.5	0.780
SO 50040-6-1/4	056.0401.110	200	10x1.0	14	21.0	15.0	9.0	4.5	1.800
SO 50040-6-3/8	056.0401.120	200	10x1.0	17	20.0	14.0	7.6	4.5	2.270
SO 50040-6-1/2	056.0401.125	200	10x1.0	22	23.0	17.0	8.8	4.5	4.450
SO 50040-8-1/8	056.0401.160	200	12x1.0	14	18.0	11.0	7.0	6.0	0.880
SO 50040-8-1/4	056.0401.170	200	12x1.0	14	22.0	15.0	9.0	6.5	1.460
SO 50040-8-3/8	056.0401.180	200	12x1.0	17	22.0	15.0	8.6	6.5	2.810
SO 50040-8-1/2	056.0401.185	200	12x1.0	22	26.0	19.0	10.8	6.5	4.970
SO 50040-10-1/8	056.0401.265	160	14x1.0	17	18.5	11.5	7.5	6.0	1.450
SO 50040-10-1/4	056.0401.270	160	14x1.0	17	22.0	15.0	9.0	8.5	1.590
SO 50040-10-3/8	056.0401.280	160	14x1.0	17	22.0	15.0	8.6	8.5	2.320
SO 50040-10-1/2	056.0401.285	160	14x1.0	22	23.0	16.0	7.8	8.5	4.650
SO 50040-12-1/4	056.0401.380	160	16x1.0	19	23.0	16.0	10.0	8.5	1.980
SO 50040-12-3/8	056.0401.390	160	16x1.0	19	22.0	15.0	8.6	10.5	2.200
SO 50040-12-1/2	056.0401.400	160	16x1.0	22	26.0	19.0	10.8	10.5	4.810
SO 50040-15-3/8	056.0401.532	100	20x1.5	24	24.0	16.0	9.6	10.5	3.490
SO 50040-15-1/2	056.0401.534	100	20x1.5	24	27.0	19.0	10.8	13.0	4.260
SO 50040-15-3/4	056.0401.536	100	20x1.5	27	27.5	19.5	10.0	13.0	7.960
SO 50040-18-1/2	056.0401.646	100	24x1.5	30	29.0	21.0	12.8	13.5	6.600
SO 50040-18-3/4	056.0401.648	100	24x1.5	30	29.5	21.5	12.0	15.0	8.540
SO 50040-22-3/4	056.0401.768	64	28x1.5	36	29.5	21.5	12.0	19.0	9.330

Übergangsnippel NPT

Adaptateur femelle - mâle NPT

Male adaptor NPT

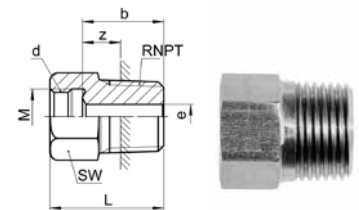

SO 50040 NPT

Type -d -RNPT	Mat.-Nr.	bar	M	SW	L	b	z	e	kg/100
RNPT=NPT Gewinde	RNPT=Filetage NPT	RNPT=NPT thread							
SO 50040-5-1/8 NPT	056.0402.082	250	8x1.0	10	19.0	13.0	8.9	3.5	0.850
SO 50040-6-1/8 NPT	056.0402.100	200	10x1.0	12	19.0	13.0	8.9	5.0	0.850
SO 50040-6-1/4 NPT	056.0402.110	200	10x1.0	14	23.0	17.0	11.2	4.5	2.050
SO 50040-8-1/4 NPT	056.0402.170	200	12x1.0	14	24.0	17.0	11.2	6.5	1.640
SO 50040-10-1/4 NPT	056.0402.270	160	14x1.0	17	24.0	17.0	11.2	8.5	1.730
SO 50040-10-3/8 NPT	056.0402.280	160	14x1.0	17	24.0	17.0	11.0	8.5	2.610
SO 50040-12-1/4 NPT	056.0402.380	160	16x1.0	19	25.0	18.0	12.2	8.5	2.110
SO 50040-12-3/8 NPT	056.0402.390	160	16x1.0	19	25.0	18.0	12.0	10.5	2.480
SO 50040-12-1/2 NPT	056.0402.400	160	16x1.0	22	29.0	22.0	13.9	10.5	5.520
SO 50040-15-1/2 NPT	056.0402.534	100	20x1.5	24	30.0	22.0	13.9	13.0	4.850

Fortsetzung nächste Seite

Suite à la prochaine page

Continued on next page

Übergangsnippel METR

Adaptateur femelle - mâle METR

Male adaptor METR

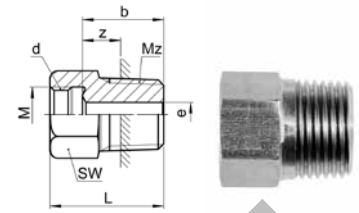

SO 50040 METR

Type -d -Mz	Mat.-Nr.	bar	M	SW	L	b	z	e	kg/100
Mz=metrisches Gewinde (zylindrisch)	Mz=Filetage métrique (cylindrique)	Mz=Metric thread (parallel)							
SO 50040-5-M6x0,75	056.0403.115	250	8x1.0	10	15.0	9.0	6.2	2.5	0.450
SO 50040-5-M8x1	056.0403.125	250	8x1.0	10	17.0	11.0	7.5	3.5	0.570

Anwendungsbeispiele:

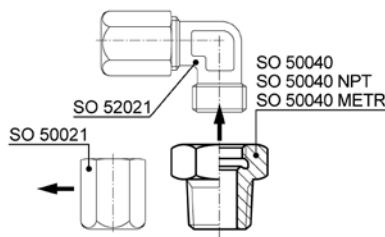

Der Übergangsnippel kann auf jedes SERTO-Formteil mit dem passenden zylindrischen Gewinde geschraubt werden und muss mit 1/4 Umdrehung angezogen werden.

Dichtungsprinzip: Bei der Montage drückt sich die Dichtkante des Übergangsstückes in das SERTO-Formteil ein, dadurch entsteht eine einwandfreie Dichtung. Wir empfehlen, das Gewinde mit einem geeigneten Flüssigklebstoff gegen unbeabsichtigtes Lösen zu sichern.

Exemples d'utilisation:

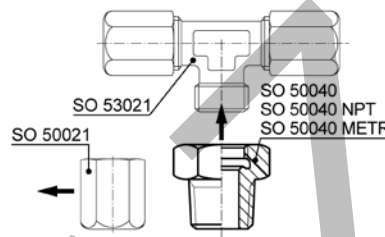

L'adaptateur mâle peut être vissé à toute pièce moulée SERTO avec le filetage cylindrique approprié et doit être serré de 1/4 de tour.

Principe d'étanchéité: Lors de l'assemblage, l'arête d'étanchéité de l'adaptateur appuie sur la pièce moulée SERTO, créant ainsi une étanchéité parfaite. Nous recommandons de fixer le filetage avec une colle liquide appropriée pour empêcher le desserrage involontaire.

Sample combinations:

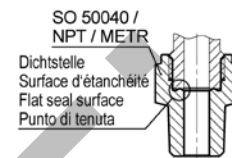

The male adaptor can be screwed onto all SERTO moulded parts with a matching cylindrical thread and must be tightened with 1/4 turn.

Sealing principle: During assembly, the sealing edge of the male adaptor presses into the SERTO moulded part to produce a perfect seal. We recommend that the thread is secured against accidental unscrewing by means of a suitable liquid adhesive.

Schlauchtülle

Douille cannelée

Hose nozzle

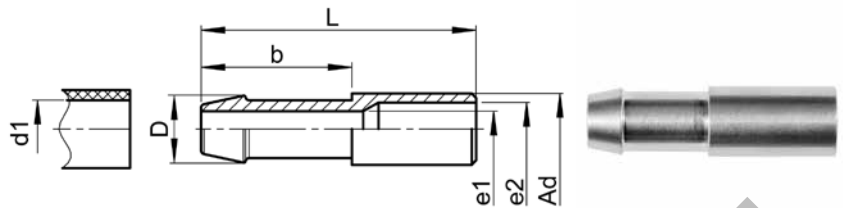

SO 50503

Type -Ad -d1	Mat.-Nr.	L	D	b	e1	e2	kg/100
SO 50503-A6-4	056.0500.110	25.0	5.0	11.0	3.0	4.0	0.230
SO 50503-A6-6	056.0500.122	31.0	7.5	17.0	4.0	4.0	0.460
SO 50503-A8-6	056.0500.140	33.0	7.5	17.0	4.0	6.0	0.480
SO 50503-A8-8	056.0500.154	33.0	9.5	17.0	6.0	6.0	0.660
SO 50503-A10-8	056.0500.190	35.0	9.5	17.0	6.0	8.0	0.860
SO 50503-A10-10	056.0500.198	37.0	11.5	19.0	8.0	8.0	0.980
SO 50503-A12-10	056.0500.240	37.0	11.5	19.0	8.0	9.2	1.220
SO 50503-A12-13	056.0500.260	39.0	15.0	21.0	9.2	9.2	1.960
SO 50503-A15-13	056.0500.430	41.0	15.0	21.0	11.0	11.0	2.120
SO 50503-A18-16	056.0500.620	47.0	18.0	26.0	13.0	14.0	2.720
SO 50503-A22-19	056.0500.760	50.0	21.5	26.0	16.0	18.0	4.530

Anwendungsbeispiele:

Exemples d'utilisation:

Sample combinations:

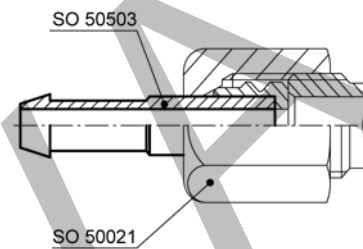

Mit dieser Schlauchtülle können Schläuche und Rohre aus Kunststoff wie z.B. PTFE, PVDF, Polyamid usw. direkt an SERTO-Verschraubungen angeschlossen werden.

Für die Schlauchsicherung verwenden Sie bitte Schlauchklemme SO 40512 (siehe Kapitel 21).

Avec ce douille cannelée, les tuyaux et les tubes en plastique comme p.exp. PTFE, PVDF, polyamide, etc. peuvent être branchés directement au raccord fileté SERTO.

Pour fixer le tuyau, utilisez le collier de serrage SO 40512 (voir chapitre 21).

With this hose nozzle, hoses and tubes made of plastic, e.g. PTFE, PVDF, polyamide etc. can be connected directly to SERTO unions. To secure the hose, use the SO 40512 hose clamp (see chapter 21).

Schlauchtülle vormontiert

Douille cannelée prémontée

Hose nozzle pre-assembled

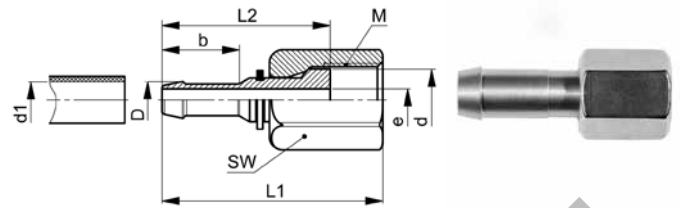

SO 50526

Type-d-d1	Mat.-Nr.	M	SW	L1	L2	D	b	e	kg/100
SO 50526-A6-4	058.0520.110	10x1.0	12	30.0	23.0	5.0	10.5	3.0	1.060
SO 50526-A6-6	058.0520.122	10x1.0	12	38.0	32.0	7.5	17.0	4.0	1.280
SO 50526-A8-6	058.0520.140	12x1.0	14	37.0	30.0	7.5	17.0	4.0	1.750
SO 50526-A8-8	058.0520.154	12x1.0	14	41.0	34.5	9.5	17.0	6.0	1.790
SO 50526-A10-8	058.0520.190	14x1.0	17	40.0	32.0	9.5	16.5	6.0	2.950
SO 50526-A10-10	058.0520.198	14x1.0	17	45.0	38.0	11.5	19.0	8.0	2.960
* SO 50526-A12-8	058.0520.225	16x1.0	19	41.5	36.0	9.5	17.0	6.0	3.400
SO 50526-A12-10	058.0520.240	16x1.0	19	43.0	35.0	11.5	18.5	8.0	4.090
SO 50526-A12-13	058.0520.260	16x1.0	19	47.0	40.0	15.0	21.0	9.2	4.530
SO 50526-A15-13	058.0520.430	20x1.5	24	49.0	40.0	15.0	21.0	10.0	7.290
SO 50526-A18-16	058.0520.620	24x1.5	30	55.0	46.0	18.0	25.5	13.0	11.300
SO 50526-A22-19	058.0520.760	28x1.5	32	57.0	49.0	21.5	25.5	16.0	14.500

Mit dieser Schlauchtülle können Schläuche und Rohre aus Kunststoff wie z.B. PTFE, PVDF, Polyamid usw. direkt an SERTO-Verschraubungen angeschlossen werden. Für die Schlauchsicherung verwenden Sie bitte Schlauchklemme SO 40512 (siehe Kapitel 21).

Montagehinweis: Anschlussmutter mit 1/4 Umdrehung anziehen. Wir empfehlen eine zusätzliche Schmierung auf der Planfläche.

Avec ce douille cannelée, les tuyaux et les tubes en plastique comme p.ex. PTFE, PVDF, polyamide, etc. peuvent être branchés directement au raccord fileté SERTO. Pour fixer le tuyau, utilisez le collier de serrage SO 40512 (voir chapitre 21).

Note d'installation: Serrez l'écrou de 1/4 de tour. Nous recommandons une lubrification supplémentaire sur la surface plane.

With this hose nozzle, hoses and tubes made of plastic, e.g. PTFE, PVDF, polyamide etc. can be connected directly to SERTO unions. To secure the hose, use the SO 40512 hose clamp (see chapter 21).

Assembly information: Tighten the union nut with 1/4 turn. We recommend additional lubrication on the plane surface.

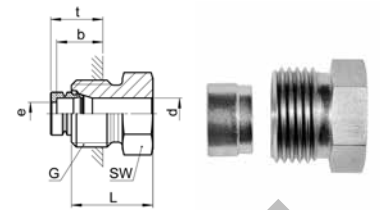
Anschlussnippel
Ecrou de raccordement mâle
Nipple connection

SO 51001

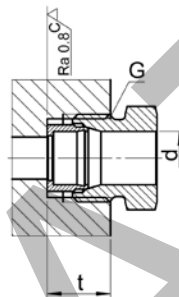
Type -d-G	Mat.-Nr.	bar	SW	L	b	t	e	kg/100
G=Rohrgewinde (zylindrisch)			G=Filetage-gaz BSP (cylindrique)				G=BSP thread (parallel)	
SO 51001-6-1/4	058.0901.110	200	14	16.0	8.3	9.5	4.5	1.470
SO 51001-8-1/4	058.0901.170	200	14	14.0	9.8	10.0	6.5	1.120
SO 51001-10-3/8	058.0901.280	160	17	16.0	8.8	10.0	8.5	2.000
SO 51001-12-1/2	058.0901.400	160	22	19.0	12.8	14.0	10.0	3.760

Anwendungsbeispiele:
Exemples d'utilisation:
Sample combinations:

Gerade Verschraubung

Union double

Straight union

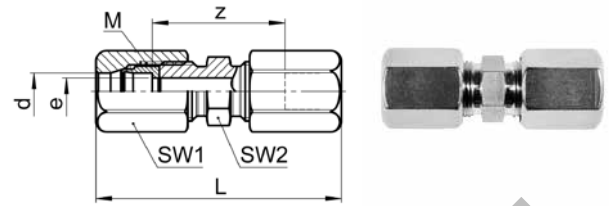

SO 51021

Type -d	Mat.-Nr.	bar	M	SW1	SW2	L	z	e	kg/100
Für metrische Rohre	Pour tubes métriques		For metric tubes						
SO 51021-2	058.1020.020	250	6x0.75	8	8	23.0	16.0	1.5	0.770
SO 51021-3	058.1020.030	250	6x0.75	8	8	26.5	16.5	2.2	0.850
SO 51021-4	058.1020.040	250	8x1.0	10	10	33.0	22.0	3.5	1.690
SO 51021-5	058.1020.050	250	8x1.0	10	10	34.0	22.0	3.5	1.650
SO 51021-6	058.1020.060	200	10x1.0	12	10	38.5	22.5	4.5	2.460
SO 51021-8	058.1020.080	200	12x1.0	14	12	42.0	25.0	6.5	3.350
SO 51021-10	058.1020.100	160	14x1.0	17	14	49.0	26.0	8.5	5.210
SO 51021-12	058.1020.120	160	16x1.0	19	17	51.5	26.5	10.0	6.560
* SO 51021-14	058.1020.140	100	20x1.5	24	22	60.0	32.0	12.0	12.680
SO 51021-15	058.1020.150	100	20x1.5	24	22	60.0	32.0	13.0	12.220
* SO 51021-16	058.1020.160	100	24x1.5	30	24	64.0	33.0	14.0	18.760
SO 51021-18	058.1020.180	100	24x1.5	30	24	64.0	33.0	15.0	19.540
SO 51021-22	058.1020.220	64	28x1.5	32	30	72.0	34.0	19.0	23.550
SO 51021-28	058.1020.280	40	36x2.0	41	36	81.0	42.0	24.0	44.500
Für Zollrohre	Pour tubes pouces		For inch tubes						
SO 51021-3,2	058.1020.032	250	6x0.75	8	8	26.5	16.5	2.2	0.980
SO 51021-6,35	058.1020.063	200	10x1.0	12	10	38.5	22.5	4.5	2.420
SO 51021-9,52	058.1020.095	160	14x1.0	17	14	49.0	26.0	8.0	5.270
SO 51021-12,7	058.1020.127	160	20x1.5	24	22	59.0	32.0	11.0	13.100
* SO 51021-13,5	058.1020.135	100	20x1.5	24	22	60.0	32.0	12.0	13.000
* SO 51021-17,2	058.1020.172	100	24x1.5	30	24	64.0	33.0	15.0	18.150
* SO 51021-21,3	058.1020.213	64	28x1.5	32	30	72.0	34.0	19.0	24.750

Umrechnung für "d" bei Zollrohren:

3,2 = 1/8
 6,35 = 1/4
 9,52 = 3/8
 12,7 = 1/2
 13,5 = 17/32
 17,2 = 11/16
 21,3 = 27/32

Conversion de "d" pour tubes en pouces:

3,2 = 1/8
 6,35 = 1/4
 9,52 = 3/8
 12,7 = 1/2
 13,5 = 17/32
 17,2 = 11/16
 21,3 = 27/32

Conversion for "d" for inch tubes:

3,2 = 1/8
 6,35 = 1/4
 9,52 = 3/8
 12,7 = 1/2
 13,5 = 17/32
 17,2 = 11/16
 21,3 = 27/32

Gerade Verschraubung reduziert

Union double réduite

Straight reduction union

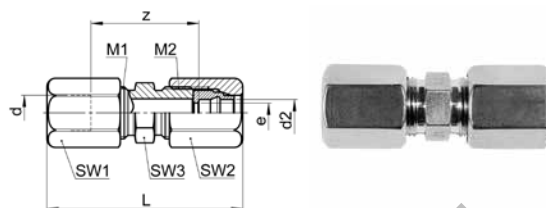

SO 51021 RED

Type -d-d2	Mat.-Nr.	bar	M1	M2	SW1	SW2	SW3	L	z	e	kg/100
Für metrische Rohre	Pour tubes métriques			For metric tubes							
SO 51021-3-2	058.1024.020	250	6x0.75	6x0.75	8	8	8	24.5	16.0	1.5	0.800
* SO 51021-5-3	058.1024.060	250	8x1.0	8x1.0	10	10	10	34.0	22.0	2.5	1.720
SO 51021-6-3	058.1024.100	200	10x1.0	6x0.75	12	8	10	32.5	19.5	2.0	2.030
* SO 51021-6-4	058.1024.110	200	10x1.0	10x1.0	12	12	10	38.5	22.5	3.5	2.550
* SO 51021-6-5	058.1024.117	200	10x1.0	10x1.0	12	12	10	38.5	22.5	4.0	2.510
* SO 51021-8-6	058.1024.140	200	12x1.0	12x1.0	14	14	12	42.0	25.0	4.5	3.510
SO 51021-10-6	058.1024.175	160	14x1.0	10x1.0	17	12	14	44.5	25.0	4.5	4.080
* SO 51021-10-8	058.1024.190	160	14x1.0	14x1.0	17	17	14	49.0	26.0	6.5	4.400
* SO 51021-12-10	058.1024.240	160	16x1.0	16x1.0	19	19	17	51.5	26.5	8.5	6.760
* SO 51021-15-12	058.1024.420	100	20x1.5	20x1.5	24	24	22	59.5	31.5	10.0	10.780
* SO 51021-15-14	058.1024.440	100	20x1.5	20x1.5	24	24	22	60.0	32.0	12.0	10.460
* SO 51021-18-15	058.1024.610	100	24x1.5	24x1.5	30	30	24	64.0	33.0	13.0	20.290
* SO 51021-18-16	058.1024.620	100	24x1.5	24x1.5	30	30	24	64.0	33.0	14.0	20.090
* SO 51021-22-18	058.1024.755	64	28x1.5	28x1.5	32	32	30	72.0	34.0	16.0	24.920
Für Zollrohre	Pour tubes pouces			For inch tubes							
* SO 51021-5-3,2	058.1024.062	250	8x1.0	8x1.0	10	10	10	34.0	22.0	2.5	2.025
SO 51021-6-6,35	058.1024.119	200	10x1.0	10x1.0	12	12	10	38.5	22.5	4.5	2.440
SO 51021-10-9,52	058.1024.197	160	14x1.0	14x1.0	17	17	14	49.0	26.0	8.0	5.240
SO 51021-15-12,7	058.1024.427	100	20x1.5	20x1.5	24	24	22	59.5	32.0	11.0	10.660
* SO 51021-15-13,5	058.1024.435	100	20x1.5	20x1.5	24	24	22	60.0	32.0	12.0	10.560
* SO 51021-18-17,2	058.1024.632	100	24x1.5	24x1.5	30	30	24	64.0	33.0	15.0	19.890
* SO 51021-22-21,3	058.1024.785	64	28x1.5	28x1.5	32	32	30	72.0	34.0	19.0	23.720

Umrechnung für "d" bei Zollrohren:

3,2 = 1/8
 6,35 = 1/4
 9,52 = 3/8
 12,7 = 1/2
 13,5 = 17/32
 17,2 = 11/16
 21,3 = 27/32

Conversion de "d" pour tubes en pouces:

3,2 = 1/8
 6,35 = 1/4
 9,52 = 3/8
 12,7 = 1/2
 13,5 = 17/32
 17,2 = 11/16
 21,3 = 27/32

Conversion for "d" for inch tubes:

3,2 = 1/8
 6,35 = 1/4
 9,52 = 3/8
 12,7 = 1/2
 13,5 = 17/32
 17,2 = 11/16
 21,3 = 27/32

Weitere Reduktionen siehe SO 51821

Autres réductions voir SO 51821

Alternative reductions see SO 51821

Gerade Einschraubverschraubung

Union mâle

Male adaptor union

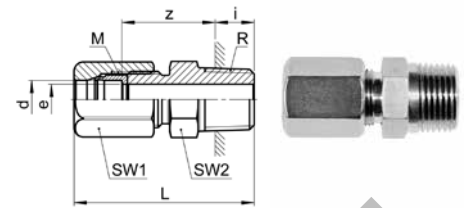

SO 51121

Type -d-R	Mat.-Nr.	bar	M	SW1	SW2	L	i	z	e	kg/100
Für metrische Rohre	Pour tubes métriques		For metric tubes							
R=Rohrgewinde (kegelig)	R=Filetage-gaz BSP (conique)		R=BSP thread (tapered)							
SO 51121-2-1/8	058.1101.020	250	6x0.75	8	10	22.5	5.0	14.0	1.5	0.800
SO 51121-3-1/8	058.1101.040	250	6x0.75	8	10	24.0	5.0	14.0	2.2	0.860
SO 51121-4-1/8	058.1101.060	250	8x1.0	10	10	26.5	5.0	16.5	3.5	1.320
* SO 51121-4-1/4	058.1101.065	200	10x1.0	12	14	35.0	8.0	19.0	3.5	2.880
SO 51121-5-1/8	058.1101.082	250	8x1.0	10	10	27.0	5.0	16.0	3.5	1.300
* SO 51121-5-1/4	058.1101.084	200	10x1.0	12	14	35.0	8.0	19.0	4.0	2.840
SO 51121-6-1/8	058.1101.100	200	10x1.0	12	10	29.0	5.0	16.0	4.5	1.690
SO 51121-6-1/4	058.1101.110	200	10x1.0	12	14	35.0	8.0	19.0	4.5	2.790
SO 51121-6-3/8	058.1101.120	200	10x1.0	12	17	35.0	8.0	19.0	4.5	3.180
SO 51121-6-1/2	058.1101.125	200	10x1.0	12	22	40.0	10.0	22.0	4.5	5.300
SO 51121-8-1/8	058.1101.160	200	12x1.0	14	12	30.5	5.0	17.0	6.0	2.090
SO 51121-8-1/4	058.1101.170	200	12x1.0	14	14	37.0	8.0	20.5	6.5	2.980
SO 51121-8-3/8	058.1101.180	200	12x1.0	14	17	37.0	8.0	20.5	6.5	3.070
SO 51121-8-1/2	058.1101.185	200	12x1.0	14	22	42.0	10.0	23.5	6.5	5.600
SO 51121-10-1/4	058.1101.270	160	14x1.0	17	14	39.5	8.0	20.0	8.5	3.530
SO 51121-10-3/8	058.1101.280	160	14x1.0	17	17	39.5	8.0	20.0	8.5	4.640
SO 51121-10-1/2	058.1101.285	160	14x1.0	17	22	44.5	10.0	23.0	8.5	6.800
SO 51121-10-3/4	058.1101.290	160	14x1.0	17	27	46.5	12.0	23.0	8.5	9.260
SO 51121-12-1/4	058.1101.380	160	16x1.0	19	17	40.0	8.0	20.0	8.5	4.590
SO 51121-12-3/8	058.1101.390	160	16x1.0	19	17	40.0	8.0	20.0	10.0	4.790
SO 51121-12-1/2	058.1101.400	160	16x1.0	19	22	45.0	10.0	23.0	10.0	7.660
* SO 51121-14-1/2	058.1101.504	100	20x1.5	24	22	49.5	10.0	25.5	12.0	8.800
SO 51121-15-3/8	058.1101.532	100	20x1.5	24	22	44.5	8.0	22.5	10.5	8.840
SO 51121-15-1/2	058.1101.534	100	20x1.5	24	22	49.5	10.0	25.5	13.0	9.030
* SO 51121-15-3/4	058.1101.536	100	24x1.5	30	27	53.0	12.0	25.5	13.0	14.470
* SO 51121-16-1/2	058.1101.566	100	24x1.5	30	24	52.0	10.0	26.5	13.5	13.040
* SO 51121-16-3/4	058.1101.568	100	24x1.5	30	27	53.0	12.0	25.5	14.0	14.220
SO 51121-18-1/2	058.1101.646	100	24x1.5	30	24	52.0	10.0	26.5	13.5	12.540
SO 51121-18-3/4	058.1101.648	100	24x1.5	30	27	53.0	12.0	25.5	15.0	13.720
SO 51121-22-3/4	058.1101.768	64	28x1.5	32	30	56.5	12.0	25.5	19.0	15.490
SO 51121-28-1	058.1101.850	40	36x2.0	41	36	64.5	14.0	31.0	24.0	18.600

Fortsetzung nächste Seite

Suite à la prochaine page

Continued on next page

d=Rohrassen-ø
 e=kleinste Bohrung
 L=Mass in montiertem Zustand
 *=mit reduziertem Klemmring

d=ø extérieur du tube
 e=ø-min. de passage
 L=après montage
 *=avec bague de serrage de réduction

d=tube outside diameter
 e=minimum bore
 L=installed length
 *=with reduction compression ferrule

Gerade Einschraubverschraubung

Union mâle

Male adaptor union

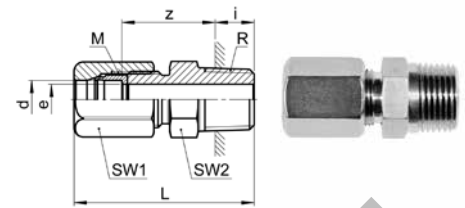

SO 51121

Type -d -R	Mat.-Nr.	bar	M	SW1	SW2	L	i	z	e	kg/100
Für Zollrohre		Pour tubes pouces				For inch tubes				
R=Rohrgewinde (kegelig)		R=Filetage-gaz BSP (conique)				R=BSP thread (tapered)				
SO 51121-3,2-1/8	058.1101.045	250	6x0.75	8	10	24.0	5.0	13.0	2.2	0.860
SO 51121-6,35-1/8	058.1101.135	200	10x1.0	12	10	29.0	5.0	16.0	4.5	1.690
SO 51121-6,35-1/4	058.1101.140	200	10x1.0	12	14	35.0	8.0	19.0	4.5	2.790
SO 51121-6,35-3/8	058.1101.145	200	10x1.0	12	17	35.0	8.0	19.0	4.5	3.180
SO 51121-6,35-1/2	058.1101.150	200	10x1.0	12	22	40.0	10.0	22.0	4.5	5.900
SO 51121-9,52-1/4	058.1101.230	160	14x1.0	17	14	34.0	8.0	20.0	8.0	3.560
SO 51121-9,52-3/8	058.1101.235	160	14x1.0	17	17	40.0	8.0	20.0	8.0	4.670
SO 51121-9,52-1/2	058.1101.240	160	14x1.0	17	22	45.0	10.0	23.0	8.0	7.500
SO 51121-12,7-1/2	058.1101.434	160	20x1.5	24	22	49.0	10.0	25.5	11.0	9.030
* SO 51121-13,5-1/2	058.1101.474	100	20x1.5	24	22	49.5	10.0	25.5	12.0	8.900
* SO 51121-17,2-1/2	058.1101.616	100	24x1.5	30	24	52.0	10.0	26.5	13.5	12.740
* SO 51121-17,2-3/4	058.1101.620	100	24x1.5	30	27	53.0	12.0	25.5	15.0	12.920
* SO 51121-21,3-3/4	058.1101.738	64	28x1.5	32	30	56.5	12.0	25.5	19.0	16.890

Umrechnung für "d" bei Zollrohren:

3,2	=	1/8
6,35	=	1/4
9,52	=	3/8
12,7	=	1/2
13,5	=	17/32
17,2	=	11/16
21,3	=	27/32

Conversion de "d" pour tubes en pouces:

3,2	=	1/8
6,35	=	1/4
9,52	=	3/8
12,7	=	1/2
13,5	=	17/32
17,2	=	11/16
21,3	=	27/32

Conversion for "d" for inch tubes:

3,2	=	1/8
6,35	=	1/4
9,52	=	3/8
12,7	=	1/2
13,5	=	17/32
17,2	=	11/16
21,3	=	27/32

d=Rohraussen-ø
 e=kleinste Bohrung
 L=Mass in montiertem Zustand
 *=mit reduziertem Klemmring

d=ø extérieur du tube
 e=ø-min. de passage
 L=après montage
 *=avec bague de serrage de réduction

d=tube outside diameter
 e=minimum bore
 L=installed length
 *=with reduction compression ferrule

Gerade Einschraubverschraubung NPT

Union mâle NPT

Male adaptor union NPT

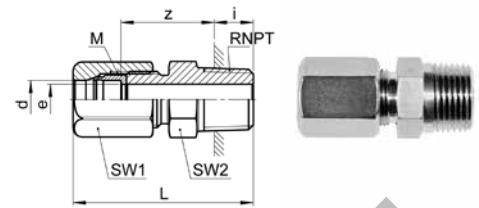

SO 51121 NPT

Type -d -RNPT	Mat.-Nr.	bar	M	SW1	SW2	L	i	z	e	kg/100
Für metrische Rohre	Pour tubes métriques		For metric tubes							
RNPT=NPT Gewinde	RNPT=Filetage NPT		RNPT=NPT thread							
SO 51121-2-1/16 NPT	058.1102.015	250	6x0.75	8	8	22.5	7.0	12.0	1.5	0.700
SO 51121-2-1/8 NPT	058.1102.020	250	6x0.75	8	12	24.5	7.0	14.0	1.5	0.900
SO 51121-3-1/16 NPT	058.1102.035	250	6x0.75	8	8	24.0	7.0	12.0	2.2	0.750
SO 51121-3-1/8 NPT	058.1102.040	250	6x0.75	8	12	26.0	7.0	14.0	2.2	1.640
SO 51121-4-1/8 NPT	058.1102.060	250	8x1.0	10	12	29.5	7.0	17.0	3.5	1.590
* SO 51121-4-1/4 NPT	058.1102.065	200	10x1.0	12	14	37.0	10.0	19.0	3.5	3.060
SO 51121-5-1/8 NPT	058.1102.082	250	8x1.0	10	12	30.0	7.0	17.0	3.5	1.570
* SO 51121-5-1/4 NPT	058.1102.084	200	10x1.0	12	14	37.0	10.0	19.0	4.0	3.020
SO 51121-6-1/8 NPT	058.1102.100	200	10x1.0	12	12	32.5	7.0	17.5	4.5	1.960
SO 51121-6-1/4 NPT	058.1102.110	200	10x1.0	12	14	37.5	10.0	19.0	4.5	2.970
* SO 51121-6-3/8 NPT	058.1102.120	200	12x1.0	14	17	39.0	10.0	20.5	4.5	2.990
* SO 51121-6-1/2 NPT	058.1102.125	200	12x1.0	14	22	45.0	14.0	22.5	4.5	3.000
SO 51121-8-1/8 NPT	058.1102.160	200	12x1.0	14	12	34.0	7.0	18.5	6.0	2.670
SO 51121-8-1/4 NPT	058.1102.170	200	12x1.0	14	14	39.0	10.0	20.5	6.5	3.150
SO 51121-8-3/8 NPT	058.1102.180	200	12x1.0	14	17	39.0	10.0	20.5	6.5	4.000
SO 51121-8-1/2 NPT	058.1102.185	200	12x1.0	14	22	45.0	14.0	22.5	6.5	5.640
SO 51121-10-1/4 NPT	058.1102.270	160	14x1.0	17	14	41.5	10.0	20.0	8.5	3.640
* SO 51121-10-3/8 NPT	058.1102.280	160	16x1.0	19	17	42.5	10.0	20.5	8.5	5.140
SO 51121-10-1/2 NPT	058.1102.285	160	14x1.0	17	22	47.5	14.0	22.0	8.5	8.270
SO 51121-12-1/4 NPT	058.1102.380	160	16x1.0	19	17	42.5	10.0	20.5	8.5	4.650
SO 51121-12-3/8 NPT	058.1102.390	160	16x1.0	19	17	42.5	10.0	20.5	10.0	4.940
SO 51121-12-1/2 NPT	058.1102.400	160	16x1.0	19	22	48.0	14.0	22.0	10.0	8.130
SO 51121-12-3/4 NPT	058.1102.405	160	16x1.0	19	27	51.0	14.0	25.0	10.0	9.000
* SO 51121-14-1/2 NPT	058.1102.504	100	20x1.5	24	22	52.5	14.0	24.5	12.0	9.650
SO 51121-15-1/2 NPT	058.1102.534	100	20x1.5	24	22	52.5	14.0	24.5	13.0	9.390
* SO 51121-16-1/2 NPT	058.1102.566	100	24x1.5	30	24	55.0	14.0	25.5	13.5	13.360
SO 51121-18-1/2 NPT	058.1102.646	100	24x1.5	30	24	55.0	14.0	25.5	13.5	17.390
* SO 51121-18-3/4 NPT	058.1102.648	64	28x1.5	32	30	60.0	14.0	27.0	16.0	17.460
SO 51121-22-3/4 NPT	058.1102.768	64	28x1.5	32	30	60.5	14.0	27.5	19.0	16.060

Fortsetzung nächste Seite

Suite à la prochaine page

Continued on next page

d=Rohrassen-ø
 e=kleinste Bohrung
 L=Mass in montiertem Zustand
 *=mit reduziertem Klemmring

d=ø extérieur du tube
 e=ø-min. de passage
 L=après montage
 *=avec bague de serrage de réduction

d=tube outside diameter
 e=minimum bore
 L=installed length
 *=with reduction compression ferrule

Gerade Einschraubverschraubung NPT

Union mâle NPT

Male adaptor union NPT

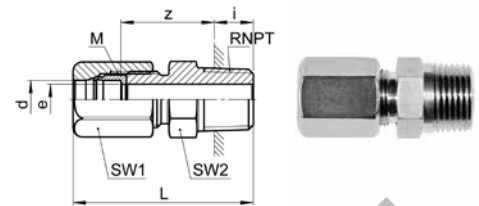

SO 51121 NPT

Type -d -RNPT	Mat.-Nr.	bar	M	SW1	SW2	L	i	z	e	kg/100
Für Zollrohre		Pour tubes pouces				For inch tubes				
RNPT=NPT Gewinde		RNPT=Filetage NPT				RNPT=NPT thread				
SO 51121-3,2-1/8 NPT	058.1102.045	250	6x0.75	8	12	26.0	7.0	14.0	2.2	1.640
SO 51121-6,35-1/4 NPT	058.1102.135	200	10x1.0	12	12	32.0	7.0	17.0	4.5	1.960
SO 51121-6,35-1/4 NPT	058.1102.140	200	10x1.0	12	14	37.0	10.0	19.0	4.5	2.970
★ SO 51121-6,35-3/8 NPT	058.1102.145	200	12x1.0	14	17	38.5	10.0	20.0	4.5	3.000
★ SO 51121-6,35-1/2 NPT	058.1102.150	200	12x1.0	14	22	45.0	14.0	22.5	4.5	3.200
SO 51121-9,52-1/4 NPT	058.1102.230	160	14x1.0	17	14	42.0	10.0	20.5	8.0	3.670
SO 51121-9,52-1/2 NPT	058.1102.240	160	14x1.0	17	22	48.0	14.0	26.5	8.0	9.400
SO 51121-12,7-1/2 NPT	058.1102.434	160	20x1.5	24	22	52.0	14.0	24.5	11.0	9.850
★ SO 51121-13,5-1/2 NPT	058.1102.474	100	20x1.5	24	22	52.5	14.0	24.5	12.0	9.750
★ SO 51121-17,2-1/2 NPT	058.1102.616	100	24x1.5	30	24	55.0	14.0	25.5	13.5	13.060
★ SO 51121-21,3-3/4 NPT	058.1102.738	64	28x1.5	32	30	60.0	14.0	27.0	19.0	17.460

Umrechnung für "d" bei Zollrohren:

3,2 = 1/8
6,35 = 1/4
9,52 = 3/8
12,7 = 1/2
13,5 = 17/32
17,2 = 11/16
21,3 = 27/32

Conversion de "d" pour tubes en pouces:

3,2 = 1/8
6,35 = 1/4
9,52 = 3/8
12,7 = 1/2
13,5 = 17/32
17,2 = 11/16
21,3 = 27/32

Conversion for "d" for inch tubes:

3,2 = 1/8
6,35 = 1/4
9,52 = 3/8
12,7 = 1/2
13,5 = 17/32
17,2 = 11/16
21,3 = 27/32

Gerade Einschraubverschraubung METR

Union mâle METR

Male adaptor union METR

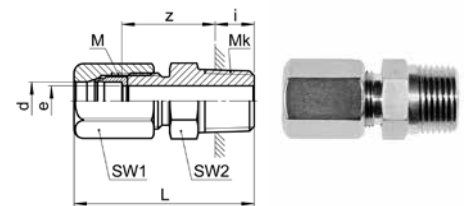

SO 51121 METR

Type -d -Mk	Mat.-Nr.	bar	M	SW1	SW2	L	i	z	e	kg/100
Mk=metrisches Gewinde (kegelig)		Mk=Filetage métrique (conique)				Mk=metric thread (tapered)				
★ SO 51121-3-M8x1	058.1103.060	250	8x1.0	10	10	28.5	6.0	16.0	2.5	1.230
SO 51121-4-M8x1	058.1103.090	250	8x1.0	10	10	28.5	6.0	16.0	3.5	1.180
SO 51121-5-M8x1	058.1103.125	250	8x1.0	10	10	28.5	6.0	16.0	4.0	1.160

d=Rohrassen-ø
 e=kleinste Bohrung
 L=Mass in montiertem Zustand
 *=mit reduziertem Klemmring

d=ø extérieur du tube
 e=ø-min. de passage
 L=après montage
 *=avec bague de serrage de réduction

d=tube outside diameter
 e=minimum bore
 L=installed length
 *=with reduction compression ferrule

Gerade Einschraubverschraubung

mit Dichtkante

Union mâle

avec arête d'étanchéité

Male adaptor union

with edge seal

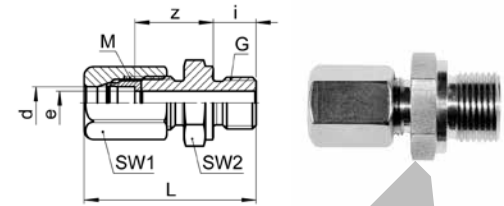

SO 51124

Type -d-G	Mat.-Nr.	bar	M	SW1	SW2	L	D	i	t	z	e	kg/100
Für metrische Rohre	Pour tubes métriques					For metric tubes						
G=Rohrgewinde (zylindrisch)	G=Filetage-gaz BSP (cylindrique)					G=BSP thread (parallel)						
SO 51124-2-1/8	058.1141.020	250	6x0.75	8	14	23.5	14.5	8.0	1.0	12.0	1.5	2.130
SO 51124-3-1/8	058.1141.040	250	6x0.75	8	14	23.0	14.5	8.0	1.0	12.0	2.2	2.130
* SO 51124-4-1/8	058.1141.060	200	10x1.0	12	14	31.0	14.5	8.0	1.0	14.5	3.4	2.170
* SO 51124-4-1/4	058.1141.065	200	10x1.0	12	19	36.0	18.5	12.0	1.5	16.0	3.4	3.640
* SO 51124-5-1/8	058.1141.082	200	10x1.0	12	14	31.0	14.5	8.0	1.0	14.5	4.0	2.130
* SO 51124-5-1/4	058.1141.084	200	10x1.0	12	19	36.0	18.5	12.0	1.5	16.0	4.0	2.080
SO 51124-6-1/8	058.1141.100	200	10x1.0	12	14	31.0	14.5	8.0	1.0	14.5	4.5	2.080
SO 51124-6-1/4	058.1141.110	200	10x1.0	12	19	36.0	18.5	12.0	1.5	16.0	4.5	3.550
SO 51124-6-3/8	058.1141.120	200	10x1.0	12	22	38.0	22.5	12.0	2.0	17.5	4.5	3.550
SO 51124-6-1/2	058.1141.125	200	10x1.0	12	27	40.5	27.0	14.0	2.5	18.0	4.5	6.800
SO 51124-8-1/8	058.1141.160	200	12x1.0	14	14	32.5	14.5	8.0	1.0	15.5	5.0	3.800
SO 51124-8-1/4	058.1141.170	200	12x1.0	14	19	38.0	18.5	12.0	1.5	17.0	6.5	3.010
* SO 51124-8-3/8	058.1141.180	160	14x1.0	17	22	42.0	22.5	12.0	2.0	18.5	6.5	6.220
SO 51124-8-1/2	058.1141.185	200	12x1.0	14	27	42.0	27.0	14.0	2.5	19.0	6.5	6.840
SO 51124-10-1/4	058.1141.270	160	14x1.0	17	19	41.0	18.5	12.0	1.5	17.0	7.0	4.560
SO 51124-10-3/8	058.1141.280	160	14x1.0	17	22	42.5	22.5	12.0	2.0	18.5	8.5	6.030
SO 51124-10-1/2	058.1141.285	160	14x1.0	17	27	45.0	27.0	14.0	2.5	19.0	8.5	8.820
SO 51124-10-3/4	058.1141.290	160	14x1.0	17	32	48.0	33.0	16.0	2.5	20.0	8.5	7.800
SO 51124-12-1/4	058.1141.380	160	16x1.0	19	19	42.0	18.5	12.0	1.5	17.0	7.0	5.300
SO 51124-12-3/8	058.1141.390	160	16x1.0	19	22	43.5	22.5	12.0	2.0	18.5	10.0	6.010
SO 51124-12-1/2	058.1141.400	160	16x1.0	19	27	46.0	27.0	14.0	2.5	19.0	10.0	7.600
SO 51124-12-3/4	058.1141.405	160	16x1.0	19	32	49.0	33.0	16.0	2.5	20.0	10.0	7.600
* SO 51124-14-1/2	058.1141.504	100	20x1.5	24	27	49.5	27.0	14.0	2.5	21.5	12.0	10.660
SO 51124-15-1/2	058.1141.534	100	20x1.5	24	27	49.5	27.0	14.0	2.5	21.5	13.0	10.420
* SO 51124-16-1/2	058.1141.566	100	24x1.5	30	27	51.0	27.0	14.0	2.5	21.5	14.0	12.850
SO 51124-18-1/2	058.1141.646	100	24x1.5	30	27	51.0	27.0	14.0	2.5	21.5	13.5	12.300
* SO 51124-18-3/4	058.1141.648	64	28x1.5	32	32	57.5	33.0	16.0	2.5	22.5	16.0	19.750
SO 51124-18-1	058.1141.652	100	24x1.5	30	41	57.0	40.0	18.0	2.5	23.5	13.5	29.000
SO 51124-22-3/4	058.1141.768	64	28x1.5	32	32	57.5	33.0	16.0	2.5	22.5	19.0	18.350
SO 51124-28-1	058.1141.850	40	36x2.0	41	41	64.5	40.0	18.0	2.5	27.0	24.0	34.800

Fortsetzung nächste Seite

Suite à la prochaine page

Continued on next page

d=Rohrassen-ø
e=kleinste Bohrung
L=Mass in montiertem Zustand
*=mit reduziertem Klemmring

d=ø extérieur du tube
e=ø-min. de passage
L=après montage
*=avec bague de serrage de réduction

d=tube outside diameter
e=minimum bore
L=installed length
*=with reduction compression ferrule

Gerade Einschraubverschraubung

mit Dichtkante

Union mâle

avec arête d'étanchéité

Male adaptor union

with edge seal

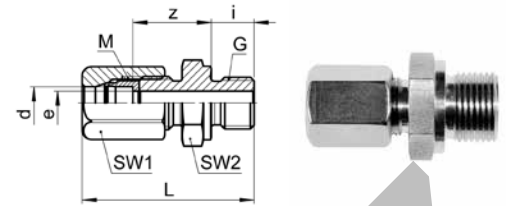

SO 51124

Type - d - G	Mat.-Nr.	bar	M	SW1	SW2	L	D	i	t	z	e	kg/100
Für Zollrohre	Pour tubes pouces						For inch tubes					
G=Rohrgewinde (zylindrisch)	G=Filetage-gaz BSP (cylindrique)						G=BSP thread (parallel)					
SO 51124-3,2-1/8	058.1141.045	250	6x0.75	8	14	25.0	14.5	8.0	1.0	12.0	2.2	2.130
SO 51124-6,35-1/8	058.1141.135	200	10x1.0	12	14	31.0	14.5	8.0	1.0	14.5	4.5	2.060
SO 51124-6,35-1/4	058.1141.140	200	10x1.0	12	19	36.5	18.5	12.0	1.5	16.0	4.5	3.530
SO 51124-6,35-3/8	058.1141.145	200	10x1.0	12	22	38.0	22.5	12.0	2.0	17.5	4.5	3.530
* SO 51124-6,35-1/2	058.1141.150	200	12x1.0	14	27	41.5	27.0	14.0	2.5	19.0	4.5	6.800
SO 51124-9,52-1/4	058.1141.230	160	14x1.0	17	19	40.5	18.5	12.0	1.5	17.0	7.0	4.590
SO 51124-9,52-3/8	058.1141.235	160	14x1.0	17	22	42.0	22.5	12.0	2.0	18.5	8.0	6.060
SO 51124-9,52-1/2	058.1141.240	160	14x1.0	17	27	44.5	27.0	14.0	2.5	19.0	8.0	8.850
SO 51124-12,7-1/2	058.1141.434	160	20x1.5	24	27	49.0	27.0	14.0	2.5	21.5	11.0	10.660
SO 51124-12,7-3/4	058.1141.536	160	20x1.5	24	32	52.0	33.0	16.0	2.5	22.5	12.0	17.000
* SO 51124-13,5-1/2	058.1141.474	100	20x1.5	24	27	49.5	27.0	14.0	2.5	21.5	11.0	10.760
* SO 51124-17,2-1/2	058.1141.616	100	24x1.5	30	27	51.0	27.0	14.0	2.5	21.5	13.5	12.550
* SO 51124-21,3-3/4	058.1141.738	64	28x1.5	32	32	57.5	33.0	16.0	2.5	22.5	19.0	19.750

Umrechnung für "d" bei Zollrohren:

3,2 = 1/8
 6,35 = 1/4
 9,52 = 3/8
 12,7 = 1/2
 13,5 = 17/32
 17,2 = 11/16
 21,3 = 27/32

Conversion de "d" pour tubes en pouces:

3,2 = 1/8
 6,35 = 1/4
 9,52 = 3/8
 12,7 = 1/2
 13,5 = 17/32
 17,2 = 11/16
 21,3 = 27/32

Conversion for "d" for inch tubes:

3,2 = 1/8
 6,35 = 1/4
 9,52 = 3/8
 12,7 = 1/2
 13,5 = 17/32
 17,2 = 11/16
 21,3 = 27/32

Einbauempfehlung:

Conseil de montage:

Recommendation for installation:

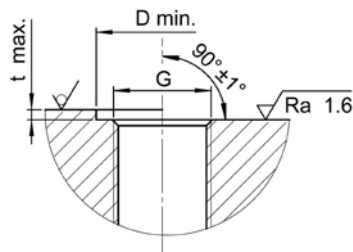

d=Rohrassen-ø
 e=kleinste Bohrung
 L=Mass in montiertem Zustand
 *=mit reduziertem Klemmring

d=ø extérieur du tube
 e=ø-min. de passage
 L=après montage
 *=avec bague de serrage de réduction

d=tube outside diameter
 e=minimum bore
 L=installed length
 *=with reduction compression ferrule

Gerade Einschraubverschraubung METR

Union mâle METR

Male adaptor union METR

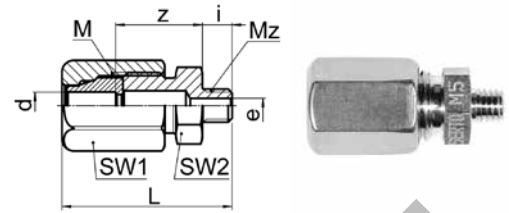

SO 51124 METR

Type -d -Mz	Mat.-Nr.	bar	M	SW1	SW2	L	i	z	e	kg/100
Für metrische Rohre	Pour tubes métriques		For metric tubes							
Mz=metrisches Gewinde (zylindrisch)	Mz=Filetage métrique (cylindrique)		Mz=Metric thread (parallel)							
SO 51124-2-M5	058.1143.020	250	6x0.75	8	8	18.0	4.5	10.0	1.5	0.500
SO 51124-2-M6x0,75	058.1143.040	250	6x0.75	8	8	19.0	5.5	10.0	1.5	0.700
SO 51124-3-M5	058.1143.050	250	6x0.75	8	8	19.5	4.5	10.0	2.2	0.540
SO 51124-3-M6x0,75	058.1143.055	250	6x0.75	8	8	20.5	5.5	10.0	2.2	0.600
SO 51124-4-M5	058.1143.080	200	8x1.0	10	8	23.0	4.5	13.0	2.2	1.580
SO 51124-5-M5	058.1143.110	200	8x1.0	10	8	23.5	4.5	13.0	2.2	1.540
SO 51124-6-M5	058.1143.155	200	10x1.0	12	10	25.5	4.5	13.0	2.2	1.490
Für Zollrohre	Pour tubes pouces		For inch tubes							
SO 51124-3,2-M5	058.1143.067	250	6x0.75	8	8	19.5	4.5	10.0	2.2	0.600
SO 51124-6,35-M5	058.1143.205	200	10x1.0	12	10	25.5	4.5	13.0	2.2	1.470

Umrechnung für "d" bei Zollrohren:

3,2 = 1/8

6,35 = 1/4

Conversion de "d" pour tubes en pouces:

3,2 = 1/8

6,35 = 1/4

Conversion for "d" for inch tubes:

3,2 = 1/8

6,35 = 1/4

Anwendungsbeispiele:

Exemples d'utilisation:

Sample combinations:

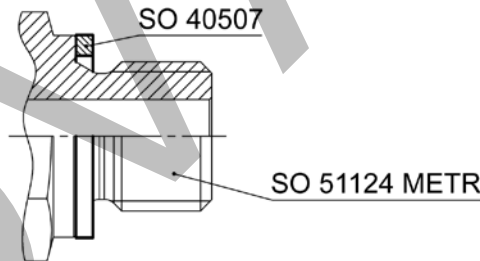

Beim Einbau empfiehlt sich die Verwendung einer Dichtscheibe (z.B. SO 40507 METR). Bei Bedarf ist die entsprechende Dichtung separat zu bestellen.

L'utilisation d'un joint (par exemple SO 40507 METR) est recommandée pour l'installation. Si nécessaire, le joint correspondant doit être commandé séparément.

The use of a sealing washer (e.g. SO 40507 METR) is recommended for installation. If required, the corresponding washer must be ordered separately.

Gerade Einschraubverschraubung

mit Conovor O-Ringabdichtung (FKM)

Union mâle

avec joint torique système Conovor (FKM)

Male adaptor union

with Conovor O-ring seal (FKM)

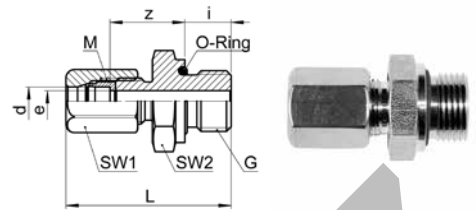

SO 51124 OR

Type -d-G	Mat.-Nr.	bar	M	SW1	SW2	L	D	i	O-Ring	t	z	e	kg/100
Für metrische Rohre	Pour tubes métriques			For metric tubes									
G=Rohrgewinde (zylindrisch)	G=Filetage-gaz BSP (cylindrique)			G=BSP thread (parallel)									
* SO 51124-4-1/8 OR	058.1171.060	200	10x1.0	12	14	30.5	14.5	8.0	8.73x1.78	1.0	14.5	3.5	2.200
* SO 51124-4-1/4 OR	058.1171.065	200	10x1.0	12	19	34.0	18.5	10.0	11.1x1.78	1.5	16.0	3.5	3.500
* SO 51124-5-1/8 OR	058.1171.082	200	10x1.0	12	14	30.5	14.5	8.0	8.73x1.78	1.0	14.5	4.0	2.100
* SO 51124-5-1/4 OR	058.1171.084	200	10x1.0	12	19	34.0	18.5	10.0	11.1x1.78	1.5	16.0	4.0	3.400
SO 51124-6-1/8 OR	058.1171.100	200	10x1.0	12	14	30.5	14.5	8.0	8.73x1.78	1.0	14.5	4.5	2.100
SO 51124-6-1/4 OR	058.1171.110	200	10x1.0	12	19	34.0	18.5	10.0	11.1x1.78	1.5	16.0	4.5	3.400
SO 51124-8-1/8 OR	058.1171.160	200	12x1.0	14	14	32.0	14.5	8.0	8.73x1.78	1.0	15.5	4.5	2.800
SO 51124-8-1/4 OR	058.1171.170	200	12x1.0	14	19	35.5	18.5	10.0	11.1x1.78	1.5	17.0	6.5	3.700
SO 51124-8-3/8 OR	058.1171.180	200	12x1.0	14	22	38.0	22.5	10.0	14.0x1.78	2.5	19.5	6.5	5.700
SO 51124-10-1/4 OR	058.1171.270	160	14x1.0	17	19	38.5	18.5	10.0	11.1x1.78	1.5	17.0	7.0	4.400
SO 51124-10-3/8 OR	058.1171.280	160	14x1.0	17	22	40.0	22.5	10.0	14.0x1.78	1.5	18.5	8.5	5.900
* SO 51124-10-1/2 OR	058.1171.285	160	16x1.0	19	27	43.5	27.0	12.0	18.72x2.62	2.5	19.0	8.5	8.100
SO 51124-12-3/8 OR	058.1171.390	160	16x1.0	19	22	40.5	22.5	10.0	14.0x1.78	1.5	18.5	10.0	6.000
SO 51124-12-1/2 OR	058.1171.400	160	16x1.0	19	27	43.0	27.0	12.0	18.72x2.62	2.5	19.0	10.0	7.400
* SO 51124-14-1/2 OR	058.1171.504	100	20x1.5	24	27	47.5	27.0	12.0	18.72x2.62	2.5	21.5	12.0	10.400
SO 51124-15-1/2 OR	058.1171.534	100	20x1.5	24	27	47.5	27.0	12.0	18.72x2.62	2.5	21.5	13.0	10.200
* SO 51124-16-1/2 OR	058.1171.566	100	24x1.5	30	27	49.0	27.0	12.0	18.72x2.62	2.5	21.5	13.0	12.500
SO 51124-18-1/2 OR	058.1171.646	100	24x1.5	30	27	49.0	27.0	12.0	18.72x2.62	2.5	21.5	13.0	12.000
* SO 51124-18-3/4 OR	058.1171.648	64	28x1.5	32	32	53.5	33.0	12.0	23.47x2.62	2.5	22.5	16.0	19.400
SO 51124-22-3/4 OR	058.1171.768	64	28x1.5	32	32	53.5	33.0	12.0	23.47x2.62	2.5	22.5	19.0	18.000
SO 51124-28-1 OR	058.1171.850	40	36x2.0	41	41	62.5	41.4	13.0	27.8x3.6	2.5	30.0	24.0	35.100
Für Zollrohre	Pour tubes pouces			For inch tubes									
SO 51124-3,2-1/8 OR	058.1171.045	200	6x0.75	8	14	26.5	14.5	8.0	8.73x1.78	1.0	13.5	2.2	1.500
SO 51124-6,35-1/8 OR	058.1171.135	200	10x1.0	12	14	30.5	14.5	8.0	8.73x1.78	1.0	14.5	4.5	2.000
SO 51124-6,35-1/4 OR	058.1171.140	200	10x1.0	12	19	34.0	18.5	10.0	11.1x1.78	1.5	16.0	4.5	3.300
SO 51124-9,52-1/4 OR	058.1171.230	160	14x1.0	17	19	38.5	18.5	10.0	11.1x1.78	1.5	17.0	7.0	4.500
SO 51124-9,52-3/8 OR	058.1171.235	160	14x1.0	17	22	40.0	22.5	10.0	14.0x1.78	1.5	18.5	8.0	5.800
SO 51124-12,7-1/2 OR	058.1171.434	160	20x1.5	24	27	47.5	27.0	12.0	18.72x2.62	2.5	21.5	11.0	10.800
* SO 51124-13,5-1/2 OR	058.1171.474	100	20x1.5	24	27	47.5	27.0	12.0	18.72x2.62	2.5	21.5	12.0	10.500
* SO 51124-17,2-1/2 OR	058.1171.616	100	24x1.5	30	27	49.0	27.0	12.0	18.72x2.62	2.5	21.5	13.0	12.200
* SO 51124-21,3-3/4 OR	058.1171.738	64	28x1.5	32	32	53.5	33.0	12.0	23.47x2.62	2.5	22.5	19.0	19.000

Umrechnung für "d" bei Zollrohren:

3,2 = 1/8
 6,35 = 1/4
 9,52 = 3/8
 12,7 = 1/2
 13,5 = 17/32
 17,2 = 11/16
 21,3 = 27/32

Conversion de "d" pour tubes en pouces:

3,2 = 1/8
 6,35 = 1/4
 9,52 = 3/8
 12,7 = 1/2
 13,5 = 17/32
 17,2 = 11/16
 21,3 = 27/32

Conversion for "d" for inch tubes:

3,2 = 1/8
 6,35 = 1/4
 9,52 = 3/8
 12,7 = 1/2
 13,5 = 17/32
 17,2 = 11/16
 21,3 = 27/32

Fortsetzung nächste Seite

Suite à la prochaine page

Continued on next page

d=Rohrassens-ø
 e=kleinste Bohrung
 L=Mass in montiertem Zustand
 *=mit reduziertem Klemmring

d=ø extérieur du tube
 e=ø-min. de passage
 L=après montage
 *=avec bague de serrage de réduction

d=tube outside diameter
 e=minimum bore
 L=installed length
 *=with reduction compression ferrule

Einbauempfehlung:

Conseil de montage:

Recommendation for installation:

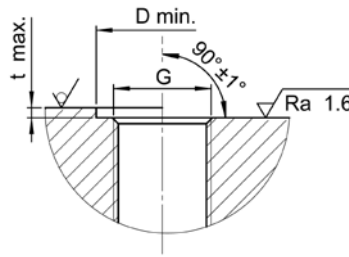

Einsatztemperaturbereich: -20 ° C bis +200 ° C

Die Vorteile dieser O-Ringabdichtung:

- keine Dichtmittelreste in Geräten
- einwandfreie Abdichtung
- keine Beschädigung von Geräten durch konische Gewinde
- schnelle Montage

Conovor patentierte O-Ring Abdichtung

Plage de température de service: -20 ° C à +200 ° C

Les avantages de cette étanchéité à joint torique:

- aucun reste de scellant dans les équipements
- une étanchéité parfaite
- aucun endommagement de l'équipement par le filetage conique
- facilité d'installation

Etanchéité à joint torique brevetée Conovor

Operating temperature range: -20 ° C to +200 ° C

Advantages of this O-ring seal:

- no sealing residues in devices
- perfect seal
- no damage to devices due to tapered thread
- rapid assembly

Conovor patented O-ring seal

KONOVOR

d=Rohrassen-ø
e=kleinste Bohrung
L=Mass in montiertem Zustand
*=mit reduziertem Klemmring

d=ø extérieur du tube
e=ø-min. de passage
L=après montage
*=avec bague de serrage de réduction

d=tube outside diameter
e=minimum bore
L=installed length
*=with reduction compression ferrule

Thermofühlerverschraubung

mit Dichtkante und mit Klemmring aus Edelstahl

Union pour sondes thermocouple

avec arête d'étanchéité et avec bague de serrage en acier inoxydable

Temperature probe union

with edge seal and with stainless steel compression ferrule

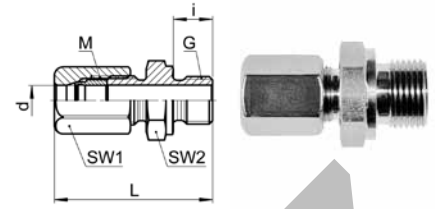

SO 51124-D

Type -d-G	Mat.-Nr.	bar	M	SW1	SW2	L	D	i	t	kg/100
G=Rohrgewinde (zylindrisch)	G=Filetage-gaz BSP (cylindrique)	G=BSP thread (parallel)								
* SO 51124-1,5-1/8 D	058.1151.009	250	6x0.75	8	14	23.5	14.5	8.0	1.0	1.370
* SO 51124-1,5-1/4 D	058.1151.011	250	6x0.75	8	19	29.0	18.5	12.0	1.5	2.630
SO 51124-2-1/8 D	058.1151.020	250	6x0.75	8	14	23.5	14.5	8.0	1.0	1.210
SO 51124-3-1/8 D	058.1151.040	250	6x0.75	8	14	25.0	14.5	8.0	1.0	1.330
SO 51124-3-1/4 D	058.1151.042	250	6x0.75	8	19	30.5	18.5	12.0	1.5	2.650
SO 51124-3-1/2 D	058.1151.044	250	6x0.75	8	27	35.5	27.0	14.0	2.5	6.600
SO 51124-4-1/8 D	058.1151.060	200	8x1.0	10	14	28.0	14.5	8.0	1.0	1.690
SO 51124-4-1/4 D	058.1151.065	200	8x1.0	10	19	33.5	18.5	12.0	1.5	3.000
* SO 51124-4,5-1/4-D	058.1151.077	200	8x1.0	10	19	34.0	18.5	12.0	1.5	3.000
* SO 51124-5-1/8 D	058.1151.082	200	10x1.0	12	14	31.0	14.5	8.0	1.0	2.040
* SO 51124-5-1/4 D	058.1151.084	200	10x1.0	12	19	36.0	18.5	12.0	1.5	3.540
SO 51124-6-1/8 D	058.1151.100	200	10x1.0	12	14	31.0	14.5	8.0	1.0	1.880
SO 51124-6-1/4 D	058.1151.110	200	10x1.0	12	19	36.0	18.5	12.0	1.5	3.290
SO 51124-6-1/2 D	058.1151.125	200	10x1.0	12	27	41.5	27.0	14.0	2.5	7.240
* SO 51124-8-1/4 D	058.1151.170	160	14x1.0	17	19	40.5	18.5	12.0	1.5	4.840
SO 51124-10-3/8 D	058.1151.280	160	14x1.0	17	22	42.5	22.5	12.0	2.0	5.650
SO 51124-10-1/2 D	058.1151.285	160	14x1.0	17	27	45.0	27.0	14.0	2.5	7.910
SO 51124-12-3/8 D	058.1151.390	160	16x1.0	19	22	43.0	22.5	12.0	2.0	5.700
SO 51124-15-1/2 D	058.1151.534	100	20x1.5	24	27	49.5	27.0	14.0	2.5	9.880

Thermofühlerverschraubung METR

mit Dichtkante und mit Klemmring aus Edelstahl

Union pour sondes thermocouple METR

avec arête d'étanchéité et avec bague de serrage en acier inoxydable

Temperature probe union METR

with edge seal and with stainless steel compression ferrule

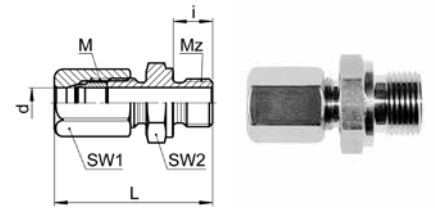

SO 51124-D METR

Type -d-Mz	Mat.-Nr.	bar	M	SW1	SW2	L	D	i	t	kg/100
Mz=metrisches Gewinde (zylindrisch)	Mz=Filetage métrique (cylindrique)	Mz=Metric thread (parallel)								
* SO 51124-1-M8x1 D	058.1153.006	250	6x0.75	8	12	23.5	12.5	8.0	1.0	0.400
* SO 51124-1,5-M6X0,75 D *	058.1153.010	250	6x0.75	8	12	18.5	9.5	5.5	1.0	0.640
* SO 51124-1,5-M8x1 D	058.1153.011	250	6x0.75	8	12	23.5	12.5	8.0	1.0	0.370
* SO 51124-1,5-M10x1 D	058.1153.012	250	6x0.75	8	14	23.5	14.5	8.0	1.0	0.410
SO 51124-2-M8x1 D	058.1153.035	250	6x0.75	8	12	23.5	12.5	8.0	1.0	0.390
* SO 51124-2,5-M8x1 D	058.1153.043	250	6x0.75	8	12	25.0	12.5	8.0	1.0	0.410
SO 51124-3-M8x1 D	058.1153.060	250	6x0.75	8	12	25.0	12.5	8.0	1.0	0.430
SO 51124-3-M10x1 D	058.1153.065	250	6x0.75	8	14	25.0	14.5	8.0	1.0	0.470
* SO 51124-3,5-M8x1 D	058.1153.068	200	8x1.0	10	12	29.0	12.5	8.0	1.0	0.720
SO 51124-4-M8X1 D	058.1153.090	200	8x1.0	10	12	28.0	12.5	8.0	1.0	1.460
SO 51124-4-M10x1 D	058.1153.096	200	8x1.0	10	14	28.0	14.5	8.0	1.0	0.800
* SO 51124-5-M10x1 D	058.1153.135	200	10x1.0	12	14	30.5	14.5	8.0	1.0	1.220
SO 51124-6-M10x1 D	058.1153.180	200	10x1.0	12	14	30.5	14.5	8.0	1.0	1.160

Fortsetzung nächste Seite

Suite à la prochaine page

Continued on next page

d=Rohrassens-ø
L=Mass in montiertem Zustand
*=mit reduziertem Klemmring

d=ø extérieur du tube
L=après montage
*=avec bague de serrage de réduction

d=tube outside diameter
L=installed length
*=with reduction compression ferrule

Einbauempfehlung:

Conseil de montage:

Recommendation for installation:

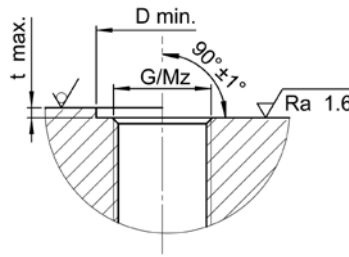

Anwendungsbeispiele:

Exemples d'utilisation:

Sample combinations:

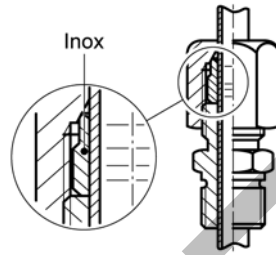

Temperatur bis +300 °C

Der Klemmring presst sich bei der ersten Montage – durch Anziehen der Mutter – auf das Rohr bleibend auf, es entsteht eine metallische Dichtung.

Die Verbindung kann durch Lösen der Mutter demontiert werden, wobei allerdings der Klemmring auf dem Rohr haften bleibt. Es ist nach der Erstmontage kein Verschieben des Rohres möglich.

Für nachträgliches Verschieben des Klemmringes wird der Einsatz der Durchgangsverschraubungen mit PTFE-Klemmring SO 51194-D-PTFE empfohlen.

* Für die Größe M6x0.75 empfiehlt sich die Verwendung der Dichtung SO 40507. Bei Bedarf ist die entsprechende Dichtung separat zu bestellen.

Température jusqu'au +300 °C

Au premier serrage du raccord la bague de serrage étrangle légèrement le tube. Le résultat est une étanchéité métal sur métal.

Par desserrage de l'écrou le raccord peut être démonté. La bague de serrage reste sur le tube. Un déplacement du tube n'est pas possible après le premier montage.

Pour un déplacement ultérieur de la bague de serrage, il est recommandé d'utiliser les unions pour sondes thermocouple avec bague de serrage en PTFE, SO 51194-D-PTFE.

* Pour la dimension M6x0.75 nous recommandons l'utilisation du joint SO 40507. Si nécessaire, le joint correspondant doit être commandé séparément.

Temperature up to +300 °C

When mounted for the first time, the compression ferrule is pressed onto the tube by tightening the nut. A metal sealing is the result.

The union can be demounted by loosening the nut. However, the compression ferrule remains on the tube. A displacement of the tube is not possible after the first mounting.

For later displacement of the compression ferrule, the use of the temperature probe union with PTFE compression ferrule SO 51194-D-PTFE is recommended.

* For size M6x0.75 we recommend the use of the washer SO 40507. If necessary, the relevant washer must be ordered separately.

d=Rohrussen-ø
L=Mass in montiertem Zustand
*=mit reduziertem Klemmring

d=ø extérieur du tube
L=après montage
*=avec bague de serrage de réduction

d=tube outside diameter
L=installed length
*=with reduction compression ferrule

Thermofühlerverschraubung

mit Dichtkante und mit PTFE-Klemmring

Union pour sondes thermocouple

avec arête d'étanchéité et avec bague de serrage en PTFE

Temperature probe union

with edge seal and with PTFE compression ferrule

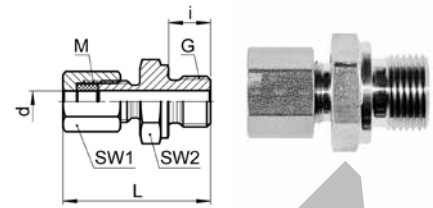

SO 51194-D-PTFE

Type -d-G	Mat.-Nr.	bar	M	SW1	SW2	L	D	i	t	kg/100
G=Rohrgewinde (zylindrisch)	G=Filetage-gaz BSP (cylindrique)	G=BSP thread (parallel)								
SO 51194-1-1/4	058.1165.002	6	6x0.75	8	19	29.0	18.5	12.0	1.5	2.640
SO 51194-1-1/2	058.1165.004	6	6x0.75	8	27	34.0	27.0	14.0	2.5	6.320
SO 51194-1,5-1/4	058.1165.011	6	6x0.75	8	19	29.0	18.5	12.0	1.5	2.640
SO 51194-1,5-1/2	058.1165.013	6	6x0.75	8	27	34.0	27.0	14.0	2.5	6.340
SO 51194-2-1/8	058.1165.020	6	6x0.75	8	14	23.5	14.5	8.0	1.0	1.260
SO 51194-2-1/4	058.1165.021	6	6x0.75	8	19	29.0	18.5	12.0	1.5	2.630
SO 51194-2-1/2	058.1165.023	6	6x0.75	8	27	34.0	27.0	14.0	2.5	6.310
SO 51194-2,5-1/8	058.1165.030	6	6x0.75	8	14	23.5	14.5	8.0	1.0	1.250
SO 51194-2,5-1/4	058.1165.031	6	6x0.75	8	19	29.5	18.5	12.0	1.5	2.620
SO 51194-2,5-1/2	058.1165.033	6	6x0.75	8	27	34.0	27.0	14.0	2.5	6.290
SO 51194-3-1/8	058.1165.040	6	6x0.75	8	14	23.5	27.0	8.0	1.0	1.370
SO 51194-3-1/4	058.1165.042	6	6x0.75	8	19	29.0	18.5	12.0	1.5	1.250
SO 51194-3-1/2	058.1165.044	6	6x0.75	8	27	34.0	27.0	14.0	2.5	2.610
SO 51194-3,5-1/8	058.1165.047	6	8x1.0	10	14	28.0	14.5	8.0	1.0	6.280
SO 51194-3,5-1/4	058.1165.049	6	8x1.0	10	19	33.5	18.5	12.0	1.5	1.250
SO 51194-4-1/8	058.1165.060	6	8x1.0	10	14	28.0	14.5	8.0	1.0	1.680
SO 51194-4-1/4	058.1165.065	6	8x1.0	10	19	33.5	18.5	12.0	1.5	2.880
SO 51194-4-1/2	058.1165.070	6	8x1.0	10	27	38.5	27.0	14.0	2.5	6.680
SO 51194-4,5-1/8	058.1165.076	6	8x1.0	10	14	28.0	14.5	8.0	1.0	1.680
SO 51194-4,5-1/4	058.1165.077	6	8x1.0	10	19	33.5	18.5	12.0	1.5	2.940
SO 51194-5-1/8	058.1165.082	6	10x1.0	12	14	29.0	14.5	8.0	1.0	1.990
SO 51194-5-1/4	058.1165.084	6	10x1.0	12	19	34.5	18.5	12.0	1.5	3.220
SO 51194-5-1/2	058.1165.088	6	10x1.0	12	27	39.5	27.0	14.0	2.5	7.030
SO 51194-5-3/4	058.1165.089	6	10x1.0	12	32	42.5	33.0	16.0	2.5	14.190
SO 51194-6-1/4	058.1165.110	6	10x1.0	12	19	34.5	18.5	12.0	1.5	2.790
SO 51194-6-1/2	058.1165.125	6	10x1.0	12	27	39.5	27.0	14.0	2.5	6.880
SO 51194-6-3/4	058.1165.126	6	10x1.0	12	32	42.5	33.0	16.0	2.5	13.900
SO 51194-8-1/4	058.1165.170	6	14x1.0	17	19	36.5	18.5	12.0	1.5	4.080
SO 51194-8-3/8	058.1165.180	6	14x1.0	17	22	38.0	22.5	12.0	2.5	5.310
SO 51194-8-1/2	058.1165.185	6	14x1.0	17	27	40.5	27.0	14.0	2.5	7.010
SO 51194-8-3/4	058.1165.190	6	14x1.0	17	32	44.5	33.0	16.0	2.5	10.790
SO 51194-9-1/2	058.1165.210	6	14x1.0	17	27	40.5	27.0	14.0	2.5	6.830
SO 51194-9-3/4	058.1165.214	6	14x1.0	17	32	44.5	33.0	16.0	2.5	10.610
SO 51194-10-3/8	058.1165.280	6	14x1.0	17	22	38.0	22.5	12.0	2.0	5.030
SO 51194-10-1/2	058.1165.285	6	14x1.0	17	27	40.5	27.0	14.0	2.5	6.610
SO 51194-10-3/4	058.1165.290	6	14x1.0	17	32	44.5	33.0	16.0	2.5	10.340

Temperatur/Druck bis +200 °C und 6 bar

Température/pression jusqu'au +200 °C et 6 bar

Temperature/pressure up to +200 °C and 6 bar

Fortsetzung nächste Seite

Suite à la prochaine page

Continued on next page

Thermofühlerverschraubung METR

mit Dichtkante und mit PTFE-Klemmring

Union pour sondes thermocouple METR

avec arête d'étanchéité et avec bague de serrage en PTFE

Temperature probe union METR

with edge seal and with PTFE compression ferrule

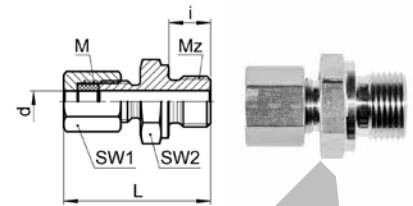

SO 51194-D-PTFE METR

Type -d -Mz	Mat.-Nr.	bar	M	SW1	SW2	L	D	i	t	kg/100
Mz=metrisches Gewinde (zylindrisch)	Mz=Filetage métrique (cylindrique)	Mz=Metric thread (parallel)								
SO 51194-0,5-M8x1	058.1167.003	6	6x0.75	8	12	23.5	12.5	8.0	1.0	1.400
SO 51194-1-M8x1	058.1167.006	6	6x0.75	8	12	23.5	12.5	8.0	1.0	1.400
SO 51194-1-M10x1	058.1167.004	6	6x0.75	8	14	23.5	14.5	8.0	1.0	1.280
SO 51194-1,5-M8x1	058.1167.011	6	6x0.75	8	12	23.5	12.5	8.0	1.0	1.020
SO 51194-1,5-M10x1	058.1167.012	6	6x0.75	8	14	23.5	14.5	8.0	1.0	1.270
SO 51194-2-M8x1	058.1167.035	6	6x0.75	8	12	23.5	12.5	8.0	1.0	1.000
SO 51194-2-M10x1	058.1167.036	6	6x0.75	8	14	23.5	14.5	8.0	1.0	1.260
SO 51194-2,5-M8x1	058.1167.043	6	6x0.75	8	12	23.5	12.5	8.0	1.0	1.000
SO 51194-2,5-M10x1	058.1167.044	6	6x0.75	8	14	23.5	14.5	8.0	1.0	1.240
SO 51194-3-M8x1	058.1167.060	6	6x0.75	8	12	23.5	12.5	8.0	1.0	0.980
SO 51194-3-M10x1	058.1167.065	6	6x0.75	8	14	23.5	14.5	8.0	1.0	1.250
SO 51194-3,5-M8x1	058.1167.075	6	8x1.0	10	12	26.5	12.5	8.0	1.0	1.380
SO 51194-4-M8x1	058.1167.090	6	8x1.0	10	12	28.0	12.5	8.0	1.0	1.330
SO 51194-4-M10x1	058.1167.096	6	8x1.0	10	14	28.0	14.5	8.0	1.0	1.068
SO 51194-5-M10x1	058.1167.135	6	10x1.0	12	14	29.0	14.5	8.0	1.0	1.980
SO 51194-6-M10x1	058.1167.180	6	10x1.0	12	14	29.0	14.5	8.0	1.0	1.790

Temperatur/Druck bis +200° C und 6 bar

Température/pression jusqu'au +200° C et 6 bar

Temperature/pressure up to +200° C and 6 bar

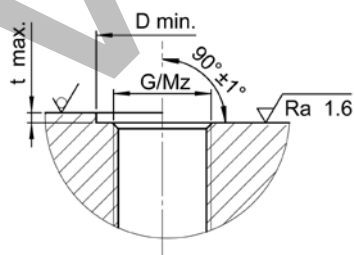
Einbauempfehlung:
Conseil de montage:
Recommendation for installation:

Fortsetzung nächste Seite

Suite à la prochaine page

Continued on next page

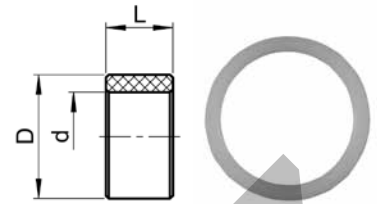
PTFE Klemmring zu SO 51194/SO 61194
**Bague de serrage en PTFE pour SO 51194/
SO 61194**
**PTFE compression ferrule for SO 51194/
SO 61194**

SO 50009

Type-d	Mat.-Nr.	L	D	kg/100
SO 50009-0,5	056.0016.505	2.5	5.0	0.010
SO 50009-1	056.0016.510	2.5	5.0	0.010
SO 50009-1,5	056.0016.515	2.5	5.0	0.010
SO 50009-2	056.0016.520	2.5	5.0	0.010
SO 50009-2,5	056.0016.525	2.5	5.0	0.010
SO 50009-3	056.0016.530	2.5	5.0	0.010
SO 50009-4	056.0016.540	4.0	6.7	0.010
SO 50009-4,5	056.0016.545	4.0	6.7	0.010
SO 50009-5	056.0016.550	4.5	8.5	0.010
SO 50009-6	056.0016.560	4.5	8.5	0.010
SO 50009-8	056.0016.580	5.5	12.5	0.010
SO 50009-9	056.0016.590	5.5	12.5	0.010
SO 50009-10	056.0016.600	5.5	12.5	0.010

Gerade Aufschraubverschraubung

Union femelle

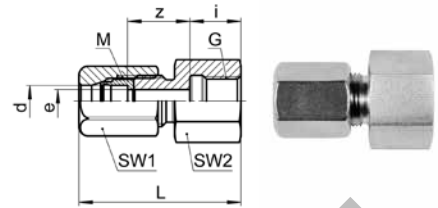
Female adaptor union



SO 51221

Type -d-G	Mat.-Nr.	bar	M	SW1	SW2	L	i	z	e	kg/100
Für metrische Rohre G=Rohrgewinde (zylindrisch)	Pour tubes métriques G=Filetage-gaz BSP (cylindrique)		For metric tubes G=BSP thread (parallel)							
★ SO 51221-3-1/8	058.1201.040	250	8x1.0	10	14	28.0	10.0	12.0	2.5	1.810
SO 51221-4-1/8	058.1201.060	250	8x1.0	10	14	27.5	10.0	12.0	3.5	1.830
★ SO 51221-4-1/4	058.1201.065	200	10x1.0	12	17	33.5	13.0	12.0	3.5	3.120
SO 51221-5-1/8	058.1201.082	250	8x1.0	10	14	28.0	10.0	12.0	3.5	1.810
★ SO 51221-5-1/4	058.1201.084	200	10x1.0	12	17	33.5	13.0	12.0	4.0	3.080
SO 51221-6-1/8	058.1201.100	200	10x1.0	12	14	30.0	10.0	12.0	4.5	2.220
SO 51221-6-1/4	058.1201.110	200	10x1.0	12	17	33.5	13.0	12.0	4.5	3.030
SO 51221-6-3/8	058.1201.120	200	10x1.0	12	22	34.5	13.0	13.0	4.5	4.570
SO 51221-6-1/2	058.1201.125	200	10x1.0	12	27	39.5	15.0	17.0	4.5	8.470
SO 51221-8-1/8	058.1201.160	200	12x1.0	14	14	32.0	10.0	13.0	6.5	2.550
SO 51221-8-1/4	058.1201.170	200	12x1.0	14	17	35.0	13.0	13.0	6.5	3.250
★ SO 51221-8-3/8	058.1201.180	160	14x1.0	17	22	39.0	13.0	14.0	6.5	5.660
★ SO 51221-8-1/2	058.1201.185	160	14x1.0	17	27	41.0	15.0	14.0	6.5	7.870
SO 51221-10-1/4	058.1201.270	160	14x1.0	17	17	37.0	13.0	13.0	8.5	4.220
SO 51221-10-3/8	058.1201.280	160	14x1.0	17	22	39.0	13.0	14.0	8.5	5.660
SO 51221-10-1/2	058.1201.285	160	14x1.0	17	27	41.0	15.0	14.0	8.5	7.870
SO 51221-12-1/4	058.1201.380	160	16x1.0	19	17	38.5	13.0	13.0	10.0	4.920
SO 51221-12-3/8	058.1201.390	160	16x1.0	19	22	39.5	13.0	14.0	10.0	6.090
SO 51221-12-1/2	058.1201.400	160	16x1.0	19	27	41.5	15.0	14.0	10.0	8.120
★ SO 51221-14-1/2	058.1201.504	100	20x1.5	24	27	45.5	15.0	16.5	12.0	10.640
SO 51221-15-1/2	058.1201.534	100	20x1.5	24	27	45.5	15.0	16.5	13.0	10.400
★ SO 51221-16-1/2	058.1201.566	100	24x1.5	30	27	47.0	15.0	16.5	14.0	14.430
SO 51221-18-1/2	058.1201.646	100	24x1.5	30	27	47.0	15.0	16.5	15.0	13.910

Für Zollrohre

Pour tubes pouces

For inch tubes

SO 51221-6,35-1/8	058.1201.135	200	10x1.0	12	14	30.0	10.0	12.0	4.5	2.200
SO 51221-6,35-1/4	058.1201.140	200	10x1.0	12	17	34.0	13.0	12.0	4.5	3.010
SO 51221-6,35-3/8	058.1201.145	200	10x1.0	12	22	35.0	13.0	13.0	4.5	4.550
SO 51221-6,35-1/2	058.1201.150	200	10x1.0	12	27	41.0	15.0	17.0	4.5	8.480
SO 51221-9,52-1/4	058.1201.230	160	14x1.0	17	17	37.0	13.0	13.0	8.0	4.250
SO 51221-9,52-3/8	058.1201.235	160	14x1.0	17	22	38.0	13.0	14.0	8.0	5.690
SO 51221-9,52-1/2	058.1201.240	160	14x1.0	17	27	40.0	15.0	14.0	8.0	7.900
SO 51221-12,7-1/2	058.1201.434	160	20x1.5	24	27	45.0	15.0	16.5	11.0	10.840
★ SO 51221-13,5-1/2	058.1201.474	100	20x1.5	24	27	45.5	15.0	16.5	12.0	10.740
★ SO 51221-17,2-1/2	058.1201.616	100	24x1.5	30	27	47.0	15.0	16.5	15.0	14.160

Umrechnung für "d" bei Zollrohren:

6,35 = 1/4
 9,52 = 3/8
 12,7 = 1/2
 13,5 = 17/32
 17,2 = 11/16

Conversion de "d" pour tubes en pouces:

6,35 = 1/4
 9,52 = 3/8
 12,7 = 1/2
 13,5 = 17/32
 17,2 = 11/16

Conversion for "d" for inch tubes:

6,35 = 1/4
 9,52 = 3/8
 12,7 = 1/2
 13,5 = 17/32
 17,2 = 11/16

d=Rohrassen-ø
 e=kleinste Bohrung
 L=Mass in montiertem Zustand
 *=mit reduziertem Klemmring

d=ø extérieur du tube
 e=ø-min. de passage
 L=après montage
 *=avec bague de serrage de réduction

d=tube outside diameter
 e=minimum bore
 L=installed length
 *=with reduction compression ferrule

Verbindungsrippel

Pièce folle

Tube stub

SO 51300

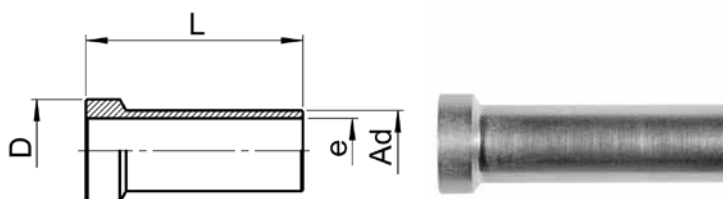

Type -Ad	Mat.-Nr.	bar	L	D	e	kg/100
SO 51300-A6	056.1300.060	200	21.0	8.9	3.8	0.410
SO 51300-A8	056.1300.080	200	24.0	10.9	5.6	0.670
SO 51300-A10	056.1300.100	160	26.0	12.9	6.5	1.200
SO 51300-A12	056.1300.120	160	31.0	14.9	8.0	1.800
SO 51300-A15	056.1300.150	100	35.0	18.4	11.0	2.700
SO 51300-A18	056.1300.180	100	39.0	22.6	14.0	4.000
SO 51300-A22	056.1300.220	64	43.0	26.4	19.0	4.400

Verbindungsrippel reduziert

Pièce folle réduite

Tube stub reduced

SO 51300 RED

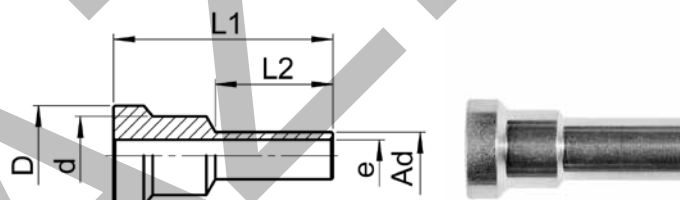

Type -d-Ad	Mat.-Nr.	bar	L1	L2	D	e	kg/100
SO 51300-8-A6	056.1304.140	200	26.0	14.0	10.9	3.8	0.740
SO 51300-10-A6	056.1304.175	200	28.0	14.0	12.9	3.8	1.100
SO 51300-10-A8	056.1304.190	200	28.0	14.0	12.9	5.6	1.100
SO 51300-12-A6	056.1304.215	200	29.0	13.0	14.9	3.8	1.700
SO 51300-12-A8	056.1304.225	200	29.0	13.5	14.9	5.6	1.600
SO 51300-12-A10	056.1304.240	160	31.0	16.0	14.9	6.5	1.800
SO 51300-15-A10	056.1304.410	160	35.0	17.0	18.4	6.5	3.100
SO 51300-15-A12	056.1304.420	160	35.0	17.5	18.4	8.0	3.100
SO 51300-18(16)-A12	056.1304.480	160	35.0	16.5	22.4	8.0	4.200
SO 51300-18(16)-A16	056.1304.620	100	41.0	31.5	22.4	12.0	4.100
SO 51300-22-A18	056.1304.755	64	47.0	26.0	26.4	14.0	6.900
SO 51300-28-A22	056.1304.900	40	55.0	31.0	33.9	19.0	10.800

Fortsetzung nächste Seite

Suite à la prochaine page

Continued on next page

Verbindungsrippel

radial demontierbar

Pièce folle

démontable radialement

Tube stub

radial dismantling

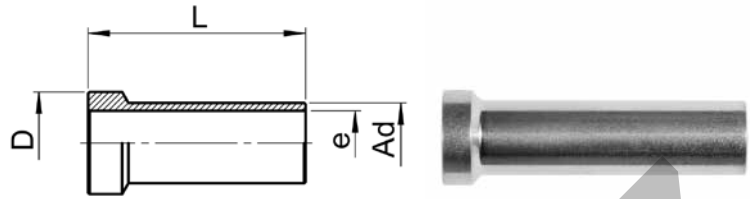
SO 51304

Type -Ad	Mat.-Nr.	bar	L	D	e	kg/100
SO 51304-A6	056.1310.060	200	32.0	8.9	3.8	0.560
SO 51304-A8	056.1310.080	200	35.0	10.9	5.6	0.900
SO 51304-A10	056.1310.100	160	40.0	12.9	6.5	1.700
SO 51304-A12	056.1310.120	160	42.0	14.9	8.0	2.400
SO 51304-A28	056.1310.280	40	62.0	33.9	25.0	8.400

Anwendungsbeispiele:

Exemples d'utilisation:

Sample combinations:

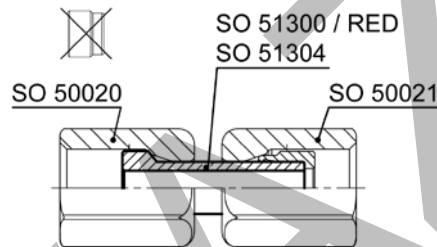

Werden die Verbindungsrippel mit einer Anschlussmutter und einem Armaturenanschluss (Anschlussmutter und Klemmring) verbunden, ergibt dies eine einstellbare Verschraubung.

Auch vormontiert erhältlich (SO 51325 / SO 51326).

Montagehinweis: Auf Seite des angedrehten Klemmringes (links im Bild) Anschlussmutter mit 1/4 Umdrehung anziehen. Auf Seite des Armaturenanschlusses (rechts im Bild) Anschlussmutter mit 1 3/4 Umdrehung anziehen.

Si l'insert de la pièce folle est relié à un écrou et à un écrou de raccordement (écrou et bague de serrage), cela fournit une union orientable.

Aussi disponible pré-assemblé (SO 51325 / SO 51326).

Note d'installation: Serrez l'écrou sur le côté de la bague de serrage tournée (à gauche sur l'illustr.) de 1/4 de tour. Serrez l'écrou de l'autre côté (à droite sur l'illustr.) de 1 3/4 tour.

If the tube stubs are coupled with a union nut and a nut connection (union nut and compression ferrule), an adjustable union is produced.

Also available pre-assembled (SO 51325 / SO 51326).

Assembly information: Tighten the union nut on the side of the turned compression ferrule (left in pict.) with 1/4 turn. Tighten the union nut on the other side (right in pict.) 1 3/4 turns.

Anwendungsbeispiele:

Exemples d'utilisation:

Sample combinations:

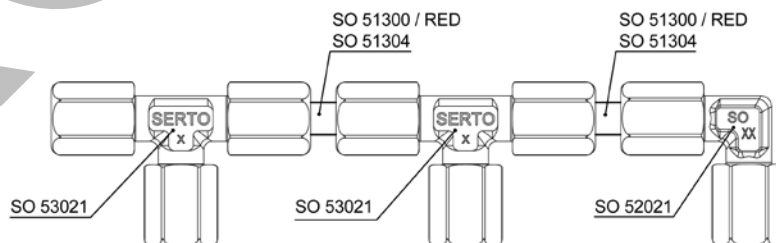

Mit der einstellbaren Verschraubung lassen sich Formteile mit dem gleichen Anschlussgewinde verbinden.

Hinweis: Nur mit Verbindungsrippel SO 51304 ist eine radiale Demontage möglich.

Avec l'union orientable, il est possible de connecter des raccords de même filetages.

Remarque: Un démontage radial n'est possible qu'avec la pièce folle SO 51304.

With the adjustable union, parts with the same connecting thread can be connected.

Note: Radial dismantling is only possible with tube stub SO 51304.

Einstellbare Verschraubung

Union orientable

Adjustable union

SO 51325

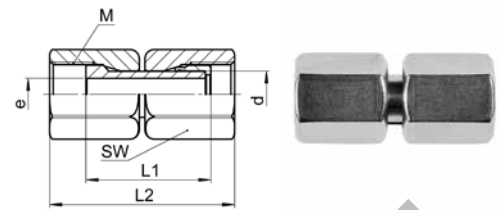

Type -d	Mat.-Nr.	bar	M	SW	L1	L2	e	kg/100
SO 51325-A6	058.1320.060	200	10x1.0	12	22.0	35.0	3.8	2.250
SO 51325-A8	058.1320.080	200	12x1.0	14	25.0	39.5	5.6	3.140
SO 51325-A10	058.1320.100	160	14x1.0	17	28.0	42.5	6.5	3.520
SO 51325-A12	058.1320.120	160	16x1.0	19	32.0	46.0	8.0	7.160
SO 51325-A15	058.1320.150	100	20x1.5	24	36.5	53.0	11.0	13.000
SO 51325-A18	058.1320.180	100	24x1.5	30	40.5	56.5	14.0	21.360
SO 51325-A22	058.1320.220	64	28x1.5	32	44.5	60.0	19.0	23.000

Einstellbare Verschraubung

radial demontierbar

Union orientable

démontable radialement

Adjustable union

radial dismantling

SO 51326

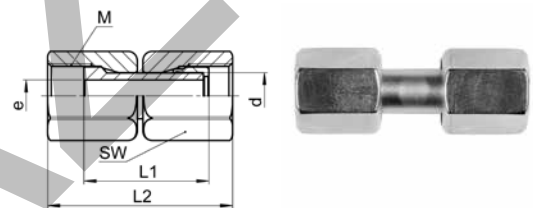

Type -d	Mat.-Nr.	bar	M	SW	L1	L2	e	kg/100
SO 51326-A6	058.1330.060	200	10x1.0	12	33.0	45.5	3.8	2.400
SO 51326-A8	058.1330.080	200	12x1.0	14	36.0	50.5	5.6	3.400
SO 51326-A10	058.1330.100	160	14x1.0	17	41.0	55.0	6.5	6.080
SO 51326-A12	058.1330.120	160	16x1.0	19	43.0	60.0	8.0	7.760

Mit der einstellbaren Verschraubung lassen sich Formteile mit dem gleichen Anschlussgewinde verbinden.

Montagehinweis: Beide Anschlussmutter mit 1/4 Umdrehung anziehen. Wir empfehlen eine zusätzliche Schmierung auf der Planfläche.

Avec l'union orientable, il est possible de connecter des raccords de même filetages.

Note d'installation: Serrez les deux écrous de 1/4 de tour. Nous recommandons une lubrification supplémentaire sur la surface plane.

With the adjustable union, parts with the same connecting thread can be connected.

Assembly information: Tighten both union nuts with 1/4 turn. We recommend additional lubrication on the plane surface.

Einstellbare Einschraubverschraubung

mit Dichtkante

Union mâle orientable

avec arête d'étanchéité

Adjustable male adaptor union

with edge seal

SO 51335

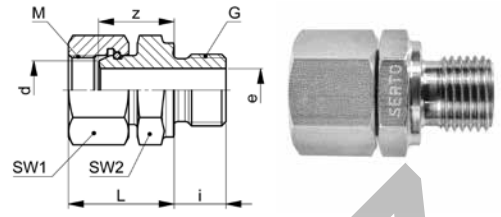

Type -d-G	Mat.-Nr.	bar	M	SW1	SW2	L	D	i	t	z	e	kg/100
G=Rohrgewinde (zylindrisch)												
				G=Filetage-gaz BSP (cylindrique)						G=BSP thread (parallel)		
SO 51335-6-1/8	058.1651.110	200	10x1.0	14	14	20.5	15.0	8.0	1.0	14.0	4.5	2.600
SO 51335-8-1/4	058.1651.170	200	12x1.0	17	19	22.5	19.0	12.0	1.5	15.0	6.5	4.000
SO 51335-10-1/4	058.1651.270	160	14x1.0	19	19	23.0	19.0	12.0	1.5	16.0	7.0	4.700
SO 51335-12-3/8	058.1651.390	160	16x1.0	22	22	24.5	23.0	12.0	2.0	17.5	10.0	6.300
SO 51335-15-1/2	058.1651.534	100	20x1.5	27	27	29.5	26.0	14.0	2.5	22.0	13.0	11.300
SO 51335-18-1/2	058.1651.648	100	24x1.5	32	27	29.5	26.0	14.0	2.5	22.0	13.0	16.000
SO 51335-22-3/4	058.1651.768	64	28x1.5	36	32	30.5	33.0	16.0	2.5	22.0	19.0	18.600

Anwendungsbeispiele:

Exemples d'utilisation:

Sample combinations:

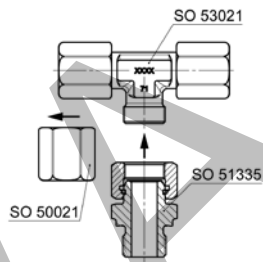

Mit der einstellbaren Einschraubverschraubung lassen sich verschiedene Grundteile einfach verbinden. Kompakte Bauweise, schnelle Montage, einfache Fixierung der Komponenten in der gewünschten Stellung.

L'union mâle orientable permet de connecter facilement différents corps de raccord. Construction compacte, montage rapide, fixation facile des composants dans la position désirée.

With the adjustable male adaptor union different basic components can easily be connected. Compact construction, quick assembly, and easy fixing of the components in the desired position.

d = Kenngröße: entspricht dem Rohraussen-Ø des Armaturenanschlusses SO 50021, der gegen die einstellbare Einschraubverschraubung SO 51335 ausgetauscht werden kann.

d = dimension nominale: correspond au dia. extérieur du tube de l'écrou et bague de raccordement SO 50021, lequel peut être échangé contre l'union mâle orientable SO 51335.

d = nominal size: corresponds to tube outside diameter of the nut connection SO 50021 which can be replaced by the adjustable male adaptor union SO 51335.

Montagehinweis: Anschlussmutter mit 1/4 Umdrehung anziehen. Wir empfehlen eine zusätzliche Schmierung auf der Planfläche.

Note d'installation: Serrez l'écrou de 1/4 de tour. Nous recommandons une lubrification supplémentaire sur la surface plane.

Assembly information: Tighten the union nut with 1/4 turn. We recommend additional lubrication on the plane surface.

Einbauempfehlung:

Conseil de montage:

Recommendation for installation:

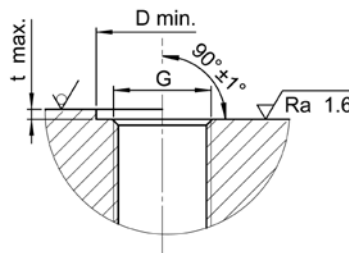

d=Rohraussen-Ø
e=kleinste Bohrung
L=Mass in montiertem Zustand

d=Ø extérieur du tube
e=Ø-min. de passage
L=après montage

d=tube outside diameter
e=minimum bore
L=installed length

5

Einstellbare Verschraubung

mit Dichtkante

Union orientable

avec arête d'étanchéité

Adjustable union

with edge seal

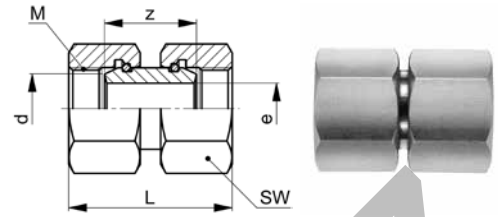
SO 51345

Type -d	Mat.-Nr.	bar	M	SW	L	z	e	kg/100
SO 51345-6	058.1350.060	200	10x1.0	14	29.0	16.0	4.5	2.790
SO 51345-8	058.1350.080	200	12x1.0	17	31.0	16.0	6.5	4.080
SO 51345-10	058.1350.100	160	14x1.0	19	32.0	18.0	8.5	4.800
SO 51345-12	058.1350.120	160	16x1.0	22	32.0	18.0	10.0	6.300
SO 51345-15	058.1350.150	100	20x1.5	27	39.0	24.0	13.0	11.200
SO 51345-18	058.1350.180	100	24x1.5	32	39.0	24.0	15.0	16.000
SO 51345-22	058.1350.220	64	28x1.5	36	39.0	22.0	19.0	18.200

Anwendungsbeispiele:

Exemples d'utilisation:

Sample combinations:

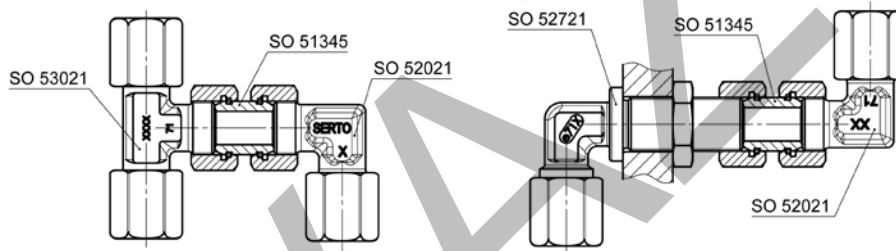

Mit der einstellbaren Verschraubung lassen sich verschiedene Grundteile einfach verbinden. Kompakte Bauweise, schnelle Montage, einfache Fixierung der Komponenten in der gewünschten Stellung.

L'union orientable permet de connecter facilement différents corps de raccord. Construction compacte, montage rapide, fixation facile des composants dans la position désirée.

With the adjustable union different basic components can easily be connected. Compact construction, quick assembly, and easy fixing of the components in the desired position.

Beachten Sie auch die Möglichkeiten mit SO 51335.

Voir également les possibilités avec SO 51335.

See SO 51335 for additional possibilities.

d = Kenngröße: entspricht dem Rohraussen- \varnothing des Armaturenanschlusses SO 50021, der gegen die einstellbare Verschraubung SO 51345 ausgetauscht werden kann.

d = dimension nominale: correspond au dia. extérieur du tube de l'écrou et bague de raccordement SO 50021, lequel peut être échangé contre l'union orientable SO 51345.

d = nominal size: corresponds to tube outside dia. of the nut connection SO 50021 which can be replaced by the adjustable union SO 51345.

Montagehinweis: Beide Anschlussmutter mit 1/4 Umdrehung anziehen. Wir empfehlen eine zusätzliche Schmierung auf der Planfläche.

Note d'installation: Serrez les deux écrous de 1/4 de tour. Nous recommandons une lubrification supplémentaire sur la surface plane.

Assembly information: Tighten both union nuts with 1/4 turn. We recommend additional lubrication on the plane surface.

Anschweisverschraubung

Union avec embout à souder

Weld-on union

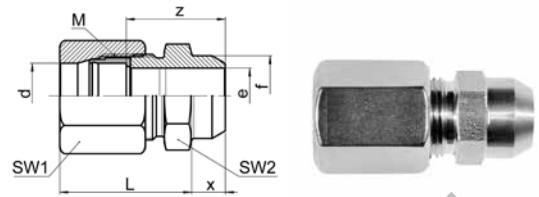
SO 51429

Type-d	Mat.-Nr.	bar	M	SW1	SW2	L	f	x	z	e	kg/100
Für metrische Rohre	Pour tubes métriques		For metric tubes								
* SO 51429-3	058.1400.030	250	8x1.0	10	8	19.0	7.5	6.0	19.0	3.5	1.050
SO 51429-4	058.1400.040	250	8x1.0	10	8	19.5	7.5	6.0	19.0	3.5	1.020
SO 51429-5	058.1400.050	250	8x1.0	10	8	19.0	7.5	6.0	19.0	3.5	1.000
SO 51429-6	058.1400.060	200	10x1.0	12	10	21.0	9.8	8.0	21.0	4.5	1.690
SO 51429-8	058.1400.080	200	12x1.0	14	12	23.5	11.8	8.0	22.0	6.5	2.250
SO 51429-10	058.1400.100	160	14x1.0	17	14	26.5	13.8	8.0	23.0	8.5	3.380
SO 51429-12	058.1400.120	160	16x1.0	19	17	28.0	16.0	8.0	24.0	10.0	4.340
* SO 51429-14	058.1400.140	100	20x1.5	24	22	33.5	19.0	10.0	29.5	12.0	8.240
SO 51429-15	058.1400.150	100	20x1.5	24	22	33.5	19.0	10.0	29.5	13.0	8.000
* SO 51429-16	058.1400.160	100	24x1.5	30	24	36.0	22.0	11.0	31.5	14.0	11.760
SO 51429-18	058.1400.180	100	24x1.5	30	24	36.0	22.0	11.0	31.5	15.0	13.100
SO 51429-22	058.1400.220	64	28x1.5	32	30	41.5	27.0	11.0	32.5	19.0	17.000
SO 51429-28	058.1400.280	40	36x2.0	41	36	45.5	32.0	14.0	40.0	24.0	22.500

Für Zollrohre	Pour tubes pouces		For inch tubes								
SO 51429-6,35	058.1400.063	200	10x1.0	12	10	21.0	9.8	8.0	21.0	4.5	1.670
SO 51429-9,52	058.1400.095	160	14x1.0	17	14	25.5	13.8	8.0	23.0	8.0	3.410
SO 51429-12,7	058.1400.127	160	20x1.5	24	22	33.0	19.0	10.0	29.5	11.0	8.440
* SO 51429-13,5	058.1400.135	100	20x1.5	24	22	33.5	19.0	10.0	29.5	12.0	8.340
* SO 51429-17,2	058.1400.172	100	24x1.5	27	24	36.0	22.0	11.0	31.5	15.0	13.350
* SO 51429-21,3	058.1400.213	64	28x1.5	32	30	40.5	27.0	11.0	32.5	19.0	18.400

Umrechnung für "d" bei Zollrohren:

6,35 = 1/4
 9,52 = 3/8
 12,7 = 1/2
 13,5 = 17/32
 17,2 = 11/16
 21,3 = 27/32

Conversion de "d" pour tubes en pouces:

6,35 = 1/4
 9,52 = 3/8
 12,7 = 1/2
 13,5 = 17/32
 17,2 = 11/16
 21,3 = 27/32

Conversion for "d" for inch tubes:

6,35 = 1/4
 9,52 = 3/8
 12,7 = 1/2
 13,5 = 17/32
 17,2 = 11/16
 21,3 = 27/32

Nach dem Anschweißen die von SERTO empfohlenen Schmierstellen mit dem Spezial-Schmieröl AC 850 nochmals schmieren.

Après le soudage, graissez les points de lubrification nécessaires, conformément aux recommandations de SERTO, avec l'huile de lubrification spéciale AC 850.

After welding, grease the necessary lubrication points as recommended by SERTO with the special lubrication oil AC 850.

d=Rohrassen-ø
 e=kleinste Bohrung
 L=Mass in montiertem Zustand
 *=mit reduziertem Klemmring

d=ø extérieur du tube
 e=ø-min. de passage
 L=après montage
 *=with reduction compression ferrule

d=tube outside diameter
 e=minimum bore
 L=installed length
 *=with reduction compression ferrule

Gerade Schottverschraubung

Durchführungslänge max. 5 mm

Union double traversée de cloison

pour cloison max. 5 mm

Panel mount union

max. panel thickness 5 mm

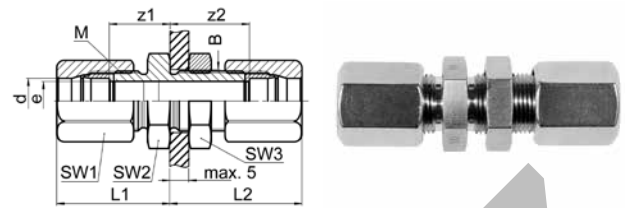

SO 51521

Type-d	Mat.-Nr.	bar	M	SW1	SW2	SW3	L1	L2	B	z1	z2	e	kg/100
Für metrische Rohre	Pour tubes métriques						For metric tubes						
SO 51521-2	058.1500.020	250	6x0.75	8	10	10	14.0	19.0	6.5	10.5	15.5	1.5	1.190
SO 51521-3	058.1500.030	250	6x0.75	8	10	10	15.5	20.5	6.5	10.5	15.5	2.2	1.270
SO 51521-4	058.1500.040	250	8x1.0	10	12	12	19.0	23.0	8.5	13.5	17.5	3.5	2.240
SO 51521-5	058.1500.050	250	8x1.0	10	12	12	19.5	23.5	8.5	13.5	17.5	3.5	2.200
SO 51521-6	058.1500.060	200	10x1.0	12	14	14	21.5	27.0	10.5	13.5	19.0	4.5	3.610
SO 51521-8	058.1500.080	200	12x1.0	14	17	17	23.5	29.5	12.5	15.0	21.0	6.5	5.210
SO 51521-10	058.1500.100	160	14x1.0	17	19	19	27.0	32.5	14.5	15.5	21.0	8.5	7.330
SO 51521-12	058.1500.120	160	16x1.0	19	22	22	28.0	33.0	16.5	16.0	21.0	10.0	9.400
Für Zollrohre	Pour tubes pouces						For inch tubes						
SO 51521-6,35	058.1500.063	200	10x1.0	12	14	14	21.5	27.0	10.5	13.5	19.0	4.5	3.570
SO 51521-9,52	058.1500.095	160	14x1.0	17	19	19	26.5	32.5	14.5	15.5	21.0	8.0	7.390

Umrechnung für "d" bei Zollrohren:

6,35 = 1/4

9,52 = 3/8

Conversion de "d" pour tubes en pouces:

6,35 = 1/4

9,52 = 3/8

Conversion for "d" for inch tubes:

6,35 = 1/4

9,52 = 3/8

Sechskantmutter siehe SO 50006 METR

Ecrou à six pans voir SO 50006 METR

Hexagon nut see SO 50006 METR

Gerade Schottverschraubung reduziert

Durchführungslänge max. 5 mm

Union double réduite traversée de cloison

pour cloison max. 5 mm

Panel mount reduction union

max. panel thickness 5 mm

SO 51521 RED

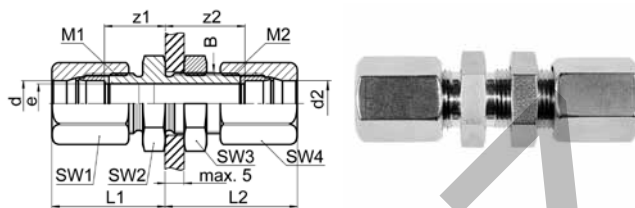

Type - d - d2	Mat.-Nr.	bar	M1	M2	SW1	SW2	SW3	SW4	L1	L2	B	z1	z2	e	kg/100	
Für metrische Rohre			Pour tubes métriques							For metric tubes						
SO 51521-3-2	058.1504.020	250	6x0.75	6x0.75	8	10	10	8	15.5	18.5	6.5	10.5	15.0	1.5	1.190	
* SO 51521-5-3	058.1504.060	250	8x1.0	8x1.0	10	12	12	10	19.5	23.5	8.5	13.5	17.5	2.5	2.290	
* SO 51521-5-4	058.1504.080	200	10x1.0	10x1.0	12	14	14	12	19.5	27.0	10.5	13.5	19.0	3.5	2.300	
* SO 51521-6-4	058.1504.110	200	10x1.0	10x1.0	12	14	14	12	21.5	27.0	10.5	13.5	19.0	3.5	3.720	
* SO 51521-6-5	058.1504.117	200	10x1.0	10x1.0	12	14	14	12	21.5	27.0	10.5	13.5	19.0	4.0	3.700	
* SO 51521-8-6	058.1504.140	200	12x1.0	12x1.0	14	17	17	14	23.5	29.5	12.5	15.0	21.0	4.5	5.370	
* SO 51521-10-4	058.1504.167	160	14x1.0	10x1.0	17	14	14	12	26.0	27.0	10.5	14.5	19.0	3.5	5.800	
* SO 51521-10-5	058.1504.170	160	14x1.0	10x1.0	17	14	14	12	26.0	27.0	10.5	14.5	19.0	4.0	5.750	
SO 51521-10-6	058.1504.175	160	14x1.0	10x1.0	17	14	14	12	26.0	27.0	10.5	14.5	19.0	4.5	5.700	
* SO 51521-10-8	058.1504.190	160	14x1.0	14x1.0	17	19	19	17	27.0	32.0	14.5	15.5	21.0	6.5	7.520	
* SO 51521-12-10	058.1504.240	160	16x1.0	16x1.0	19	22	22	19	28.0	33.5	16.5	16.0	21.0	8.5	9.600	
Für Zollrohre			Pour tubes pouces						For inch tubes							
SO 51521-6-6,35	058.1504.119	200	10x1.0	10x1.0	12	14	14	12	21.5	27.0	10.5	13.5	19.0	4.5	3.610	
* SO 51521-8-6,35	058.1504.143	200	12x1.0	12x1.0	14	17	17	14	23.5	29.0	12.5	15.0	21.0	4.5	5.350	
SO 51521-10-9,52	058.1504.197	160	14x1.0	14x1.0	17	19	19	17	27.0	32.5	14.5	15.5	21.0	8.5	7.330	

Umrechnung für "d" bei Zollrohren:

6,35 = 1/4

9,52 = 3/8

Conversion de "d" pour tubes en pouces:

6,35 = 1/4

9,52 = 3/8

Conversion for "d" for inch tubes:

6,35 = 1/4

9,52 = 3/8

Sechskantmutter siehe SO 50006 METR

Ecrou à six pans voir SO 50006 METR

Hexagon nut see SO 50006 METR

d=Rohrassen-ø
 e=kleinste Bohrung
 L=Mass in montiertem Zustand
 *=mit reduziertem Klemmring

d=ø extérieur du tube
 e=ø-min. de passage
 L=après montage
 *=avec bague de serrage de réduction

d=tube outside diameter
 e=minimum bore
 L=installed length
 *=with reduction compression ferrule

Gerade Schottverschraubung

Durchführungslänge max. 16 mm

Union double traversée de cloison

pour cloison max. 16 mm

Panel mount union

max. panel thickness 16 mm

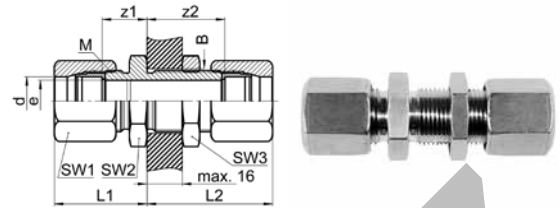

SO 51524

Type-d	Mat.-Nr.	bar	M	SW1	SW2	SW3	L1	L2	B	z1	z2	e	kg/100
Für metrische Rohre	Pour tubes métriques						For metric tubes						
* SO 51524-14	058.1540.140	100	20x1.5	24	27	27	33.5	47.5	20.5	19.5	33.5	12.0	18.010
SO 51524-15	058.1540.150	100	20x1.5	24	27	27	33.5	47.5	20.5	19.5	33.5	13.0	17.680
* SO 51524-16	058.1540.160	100	24x1.5	30	30	30	35.0	50.0	24.5	19.5	34.5	14.0	28.430
SO 51524-18	058.1540.180	100	24x1.5	30	30	30	35.0	50.0	24.5	19.5	34.5	15.0	29.080
SO 51524-22	058.1540.220	64	28x1.5	32	36	36	39.5	54.5	28.5	20.5	35.5	19.0	33.490
SO 51524-28	058.1540.280	40	36x2.0	41	41	41	45.5	61.5	36.5	26.0	42.0	24.0	72.000
Für Zollrohre	Pour tubes pouces						For inch tubes						
SO 51524-12,7	058.1540.127	160	20x1.5	24	27	27	33.0	47.0	20.5	19.5	33.5	11.0	18.410
* SO 51524-13,5	058.1540.135	100	20x1.5	24	27	27	33.5	47.5	20.5	19.5	33.5	12.0	18.210
* SO 51524-17,2	058.1540.172	100	24x1.5	30	30	30	35.0	50.0	24.5	19.5	34.5	15.0	27.830
* SO 51524-21,3	058.1540.213	64	28x1.5	32	36	36	39.5	54.5	28.5	20.5	35.5	19.0	36.290

Umrechnung für "d" bei Zollrohren:

12,7 = 1/2
 13,5 = 17/32
 17,2 = 11/16
 21,3 = 27/32

Conversion de "d" pour tubes en pouces:

12,7 = 1/2
 13,5 = 17/32
 17,2 = 11/16
 21,3 = 27/32

Conversion for "d" for inch tubes:

12,7 = 1/2
 13,5 = 17/32
 17,2 = 11/16
 21,3 = 27/32

Sechskantmutter siehe SO 50006 METR

Ecrou à six pans voir SO 50006 METR

Hexagon nut see SO 50006 METR

Gerade Schottverschraubung reduziert

Durchführungslänge max. 16 mm

Union double réduite traversée de cloison

pour cloison max. 16 mm

Panel mount reduction union

max. panel thickness 16 mm

SO 51524 RED

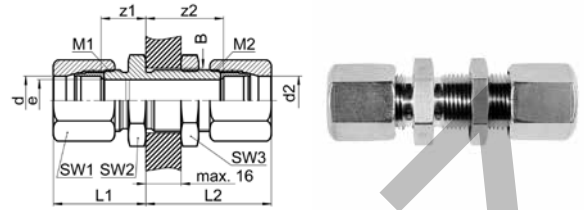

Type -d-d2	Mat.-Nr.	bar	M1	M2	SW1	SW2	SW3	L1	L2	B	z1	z2	e	kg/100	
Für metrische Rohre			Pour tubes métriques					For metric tubes							
* SO 51524-15-12	058.1544.420	100	20x1.5	20x1.5	24	27	27	33.5	47.5	20.5	19.5	33.5	10.0	18.090	
* SO 51524-15-14	058.1544.440	100	20x1.5	20x1.5	24	27	27	33.5	47.5	20.5	19.5	33.5	12.0	17.770	
* SO 51524-18-15	058.1544.610	100	24x1.5	24x1.5	30	30	30	35.0	50.0	24.5	19.5	34.5	13.0	28.080	
* SO 51524-18-16	058.1544.620	100	24x1.5	24x1.5	30	30	30	35.0	50.0	24.5	19.5	34.5	14.0	27.880	
Für Zollrohre			Pour tubes pouces					For inch tubes							
SO 51524-15-12,7	058.1544.427	100	20x1.5	20x1.5	24	27	27	33.5	47.0	20.5	19.5	33.5	14.0	17.970	
* SO 51524-15-13,5	058.1544.435	100	20x1.5	20x1.5	24	27	27	33.5	47.5	20.5	19.5	33.5	12.0	17.870	
* SO 51524-18-17,2	058.1544.632	100	24x1.5	24x1.5	30	30	30	35.0	50.0	24.5	19.5	34.5	15.0	27.580	

Umrechnung für "d" bei Zollrohren:

 12,7 = 1/2
 13,5 = 17/32
 17,2 = 11/16

Conversion de "d" pour tubes en pouces:

 12,7 = 1/2
 13,5 = 17/32
 17,2 = 11/16

Conversion for "d" for inch tubes:

 12,7 = 1/2
 13,5 = 17/32
 17,2 = 11/16

Sechskantmutter siehe SO 50006 METR

Ecrou à six pans voir SO 50006 METR

Hexagon nut see SO 50006 METR

 d=Rohrassen-ø
 e=kleinste Bohrung
 L=Mass in montiertem Zustand
 *=mit reduziertem Klemmring

 d=ø extérieur du tube
 e=ø-min. de passage
 L=après montage
 *=with reduction compression ferrule

 d=tube outside diameter
 e=minimum bore
 L=installed length
 *=with reduction compression ferrule

Einstellnippel

Adaptateur orientable mâle

Adjustable male adaptor

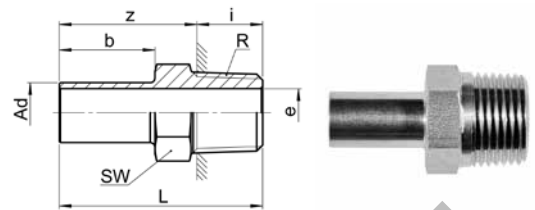

SO 51600

Type -Ad -R	Mat.-Nr.	bar	SW	L	b	i	z	e	kg/100
R=Rohrgewinde (kegelig)	R=Filetage-gaz BSP (conique)	R=BSP thread (tapered)							
SO 51600-A4-1/8	056.1601.060	250	10	22.0	10.0	5.0	17.0	2.5	0.570
SO 51600-A5-1/8	056.1601.082	250	10	22.5	10.5	5.0	17.5	3.2	0.600
SO 51600-A6-1/8	056.1601.100	200	12	27.0	14.0	5.0	22.0	4.0	0.950
SO 51600-A6-1/4	056.1601.110	200	14	32.0	14.0	8.0	24.0	4.0	1.700
SO 51600-A8-1/8	056.1601.160	200	12	29.0	15.0	5.0	24.0	6.0	0.660
SO 51600-A8-1/4	056.1601.170	200	14	33.0	15.0	8.0	25.0	6.0	1.660
SO 51600-A10-1/4	056.1601.270	160	14	35.0	17.0	8.0	27.0	7.0	1.490
SO 51600-A10-3/8	056.1601.280	160	17	35.0	17.0	8.0	27.0	7.0	2.770
SO 51600-A10-1/2	056.1601.285	160	22	39.0	16.0	10.0	29.0	7.0	5.500
SO 51600-A12-1/4	056.1601.380	160	14	36.0	18.0	8.0	28.0	8.5	1.530
SO 51600-A12-3/8	056.1601.390	160	17	36.0	18.0	8.0	28.0	9.0	2.690
SO 51600-A12-1/2	056.1601.400	160	22	41.0	18.0	10.0	31.0	9.0	5.080
SO 51600-A15-1/2	056.1601.534	100	22	44.0	21.0	10.0	34.0	12.0	4.890

Anwendungsbeispiele:

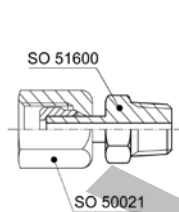

Mögliche Kombinationen:

- mit Armaturenanschluss zu einstellbaren Einschraubverschraubungen
- mit Verschraubungen/Ventilen zu einstellbaren Verschraubungen/Ventilen

Auch vormontiert erhältlich (SO 51625).

Exemples d'utilisation:

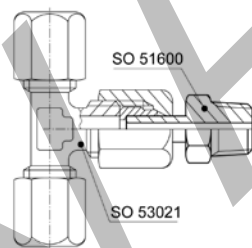

Combinaisons possibles:

- avec écrou de raccordement ça donne des unions mâle orientables
- avec raccords/vannes ça donne des raccords/vannes orientables

Aussi disponible pré-assemblé (SO 51625).

Sample combinations:

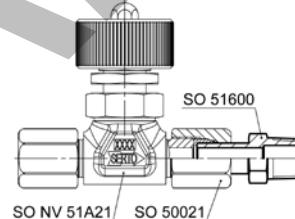

Possible combinations:

- with nut connection to adjustable male adaptor union
- with unions/valves to adjustable unions/valves

Also available pre-assembled (SO 51625).

Einstellbare Einschraubverschraubung

Union mâle orientable

Adjustable male adaptor union

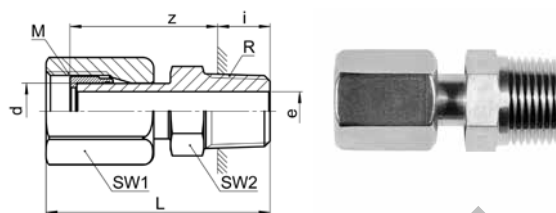

SO 51625

Type -d-R	Mat.-Nr.	bar	M	SW1	SW2	L	i	z	e	kg/100
R=Rohrgewinde (kegelig)			R=Filetage-gaz BSP (conique)					R=BSP thread (tapered)		
SO 51625-A4-1/8	058.1620.060	250	8x1.0	10	10	28.5	5.0	18.0	2.5	1.110
SO 51625-A5-1/8	058.1620.080	250	8x1.0	10	10	29.0	5.0	19.0	3.2	1.120
SO 51625-A6-1/8	058.1620.100	200	10x1.0	12	12	33.5	5.0	23.0	4.0	1.740
SO 51625-A6-1/4	058.1620.110	200	10x1.0	12	14	38.5	8.0	25.0	4.0	2.490
SO 51625-A8-1/8	058.1620.160	200	12x1.0	14	12	36.5	5.0	25.0	6.0	1.170
SO 51625-A8-1/4	058.1620.170	200	12x1.0	14	14	40.5	8.0	26.0	6.0	2.710
SO 51625-A10-1/4	058.1620.270	160	14x1.0	17	14	42.0	8.0	28.0	7.0	3.270
SO 51625-A10-3/8	058.1620.280	160	14x1.0	17	17	42.0	8.0	28.0	7.0	4.980
SO 51625-A10-1/2	058.1620.285	160	14x1.0	17	22	46.0	10.0	30.0	7.0	7.710
SO 51625-A12-1/4	058.1620.380	160	16x1.0	19	14	43.0	8.0	29.5	8.5	3.400
SO 51625-A12-3/8	058.1620.390	160	16x1.0	19	17	43.0	8.0	29.5	9.0	4.900
SO 51625-A12-1/2	058.1620.400	160	16x1.0	19	22	48.0	10.0	32.5	9.0	7.290
SO 51625-A15-1/2	058.1620.534	100	20x1.5	24	22	52.5	10.0	35.5	12.0	9.100

Montagehinweis: Anschlussmutter mit 1/4 Umdrehung anziehen.

Wir empfehlen eine zusätzliche Schmierung auf der Planfläche.

Note d'installation: Serrez l'écrou de 1/4 de tour.

Nous recommandons une lubrification supplémentaire sur la surface plane.

Assembly information: Tighten the union nut with 1/4 turn.

We recommend additional lubrication on the plane surface.

Reduktions- Einstellverschraubung

Raccord de réduction orientable

Adjustable reduction union

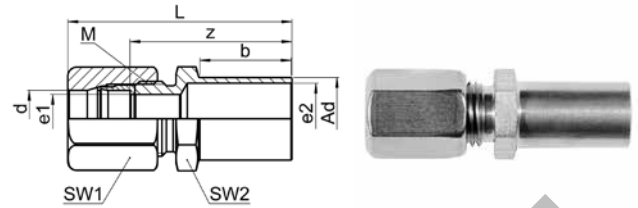
SO 51821

Type-Ad-d	Mat.-Nr.	bar	M	SW1	SW2	L	b	z	e1	e2	kg/100
Für metrische Rohre	Pour tubes métriques			For metric tubes							
* SO 51821-A10-4	058.1800.167	160	10x1.0	12	12	37.5	17.0	29.6	3.5	6.5	1.760
* SO 51821-A10-5	058.1800.170	160	10x1.0	12	12	37.5	17.0	29.6	4.0	6.5	1.720
SO 51821-A10-6	058.1800.175	160	10x1.0	12	12	37.5	17.0	29.6	4.5	6.5	1.670
* SO 51821-A12-6	058.1800.215	160	12x1.0	14	14	42.5	19.0	34.0	4.5	8.5	2.350
SO 51821-A12-8	058.1800.225	160	12x1.0	14	14	42.0	19.0	33.5	6.5	8.5	2.610
* SO 51821-A15-8	058.1800.400	100	14x1.0	17	17	47.0	21.0	36.2	6.5	11.5	4.130
SO 51821-A15-10	058.1800.410	100	14x1.0	17	17	47.5	21.0	36.2	8.5	11.5	3.940
* SO 51821-A18-10	058.1800.575	100	16x1.0	19	19	52.5	24.0	40.2	8.5	14.5	5.280
SO 51821-A18-12	058.1800.580	100	16x1.0	19	19	52.0	24.0	40.2	10.0	14.5	5.080
* SO 51821-A22-12	058.1800.730	64	20x1.5	24	24	57.5	25.0	43.5	10.0	19.0	8.920
* SO 51821-A22-14	058.1800.740	64	20x1.5	24	24	57.5	25.0	43.5	12.0	19.0	8.600
SO 51821-A22-15	058.1800.745	64	20x1.5	24	24	57.5	25.0	43.5	13.0	19.0	8.360
SO 51821-A28-22	058.1800.900	40	28x1.5	32	30	72.5	32.0	53.5	19.0	25.0	19.000

Für Zollrohre	Pour tubes pouces			For inch tubes							
SO 51821-A10-6,35	058.1800.177	160	10x1.0	12	12	37.5	17.0	29.6	4.5	6.5	1.650
SO 51821-A15-9,52	058.1800.408	100	14x1.0	17	17	47.5	21.0	36.2	8.0	11.5	3.910
SO 51821-A22-12,7	058.1800.732	64	20x1.5	24	24	57.0	25.0	43.5	11.0	19.0	8.800
* SO 51821-A22-13,5	058.1800.737	64	20x1.5	24	24	57.5	25.0	43.5	12.0	19.0	8.700

Umrechnung für "d" bei Zollrohren:

6,35 = 1/4
 9,52 = 3/8
 12,7 = 1/2
 13,5 = 17/32

Conversion de "d" pour tubes en pouces:

6,35 = 1/4
 9,52 = 3/8
 12,7 = 1/2
 13,5 = 17/32

Conversion for "d" for inch tubes:

6,35 = 1/4
 9,52 = 3/8
 12,7 = 1/2
 13,5 = 17/32

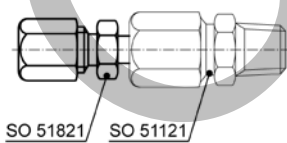
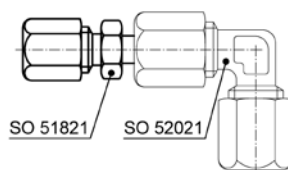
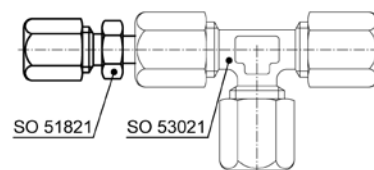
Anwendungsbeispiele:

Exemples d'utilisation:

Sample combinations:

Die Reduktion SO 51821 lässt sich mit allen SERTO-Verschraubungen kombinieren. Die zylindrische Andrehung Ad wird in die Größe d des SERTO-Anschlusses SO 50021 gesteckt und angezogen, somit ergeben sich weitere Rohrreduktionen.

La réduction SO 51821 peut se combiner avec tous les raccords SERTO. La portée cylindrique Ad s'emboîte et se serre dans la dimension d de l'écrou de connexion SERTO SO 50021, donnant ainsi d'autres réductions de tube.

The reduction SO 51821 can be combined with all SERTO unions. The cyl. turned stub Ad is inserted in the bore d of the SERTO connection SO 50021 and tightened. This permits further tube reductions.

d=Rohraussen-ø
 Ad=Aussen-ø der Andrehung
 e=kleinste Bohrung
 *=mit reduziertem Klemmring

d=ø extérieur du tube
 Ad=ø extérieur de la portée cylindrique
 e=ø-min. de passage
 *=avec bague de serrage de réduction

d=tube outside diameter
 Ad=outside diameter of cyl. stub
 e=minimum bore
 *=with reduction compression ferrule

Reduktions-Einstellverschraubung vormontiert

Raccord de réduction orientable prémonté

Adjustable reduction union pre-assembled

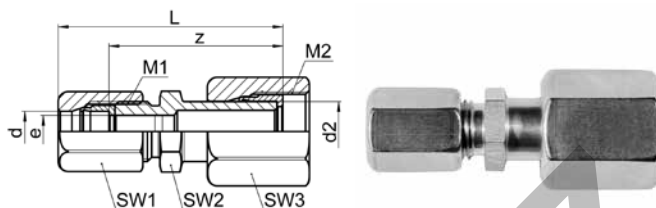
SO 51825

Type-d2-d	Mat.-Nr.	bar	M1	M2	SW1	SW2	SW3	L	z	e	kg/100
Für metrische Rohre	Pour tubes métriques			For metric tubes							
* SO 51825-A10-4	058.1820.167	160	10x1.0	14x1.0	12	12	17	38.5	30.5	3.5	3.540
* SO 51825-A10-5	058.1820.170	160	10x1.0	14x1.0	12	12	17	38.5	30.5	4.0	3.500
SO 51825-A10-6	058.1820.175	160	10x1.0	14x1.0	12	12	17	38.5	30.5	4.5	3.450
* SO 51825-A12-6	058.1820.215	160	12x1.0	16x1.0	14	14	19	43.5	35.0	4.5	4.550
SO 51825-A12-8	058.1820.225	160	12x1.0	16x1.0	14	14	19	43.5	35.0	6.5	4.820
* SO 51825-A15-8	058.1820.400	100	14x1.0	20x1.5	17	17	24	48.5	37.5	6.5	5.790
SO 51825-A15-10	058.1820.410	100	14x1.0	20x1.5	17	17	24	49.0	37.5	8.5	8.150
* SO 51825-A18-10	058.1820.575	100	16x1.0	24x1.5	19	19	30	54.0	41.5	8.5	10.300
SO 51825-A18-12	058.1820.580	100	16x1.0	24x1.5	19	19	30	53.5	41.5	10.0	10.130
* SO 51825-A22-12	058.1820.730	64	20x1.5	28x1.5	24	24	32	58.5	44.5	10.0	17.080
* SO 51825-A22-14	058.1820.740	64	20x1.5	28x1.5	24	24	32	58.5	44.5	12.0	16.760
SO 51825-A22-15	058.1820.745	64	20x1.5	28x1.5	24	24	32	58.5	44.5	13.0	16.520
Für Zollrohre	Pour tubes pouces			For inch tubes							
SO 51825-A10-6,35	058.1820.177	160	10x1.0	14x1.0	12	12	17	38.5	30.5	4.5	3.430
SO 51825-A12-6,35	058.1820.217	160	12x1.0	16x1.0	14	14	19	43.0	35.0	4.5	4.820
SO 51825-A15-9,52	058.1820.408	100	14x1.0	20x1.5	17	17	24	49.0	37.5	8.0	8.120
SO 51825-A22-12,7	058.1820.732	64	20x1.5	28x1.5	24	24	32	58.0	44.5	11.0	13.900
* SO 51825-A22-13,5	058.1820.737	64	20x1.5	28x1.5	24	24	32	58.5	44.5	12.0	13.250

Umrechnung für "d" bei Zollrohren:

6,35 = 1/4
 9,52 = 3/8
 12,7 = 1/2
 13,5 = 17/32

Conversion de "d" pour tubes en pouces:

6,35 = 1/4
 9,52 = 3/8
 12,7 = 1/2
 13,5 = 17/32

Conversion for "d" for inch tubes:

6,35 = 1/4
 9,52 = 3/8
 12,7 = 1/2
 13,5 = 17/32

Montagehinweis: Anschlussmutter auf Seite Einstellteil mit 1/4 Umdrehung anziehen. Wir empfehlen eine zusätzliche Schmierung auf der Planfläche.

Note d'installation: Serrez l'écrou du côté orientable de 1/4 de tour. Nous recommandons une lubrification supplémentaire sur la surface plane.

Assembly information: Tighten the union nut on the adjustable side with 1/4 turn. We recommend additional lubrication on the plane surface.

d=Rohrassen-ø
 e=kleinste Bohrung
 L=Mass in montiertem Zustand
 *=mit reduziertem Klemmring

d=ø extérieur du tube
 e=ø-min. de passage
 L=après montage
 *=avec bague de serrage de réduction

d=tube outside diameter
 e=minimum bore
 L=installed length
 *=with reduction compression ferrule

Winkelverschraubung

Coude

Elbow union

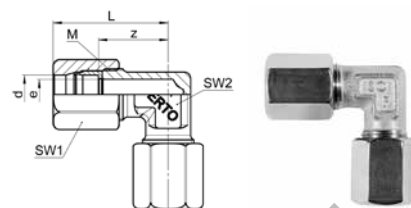

SO 52021

Type-d	Mat.-Nr.	bar	M	SW1	SW2	L	z	e	kg/100
Für metrische Rohre	Pour tubes métriques			For metric tubes					
* SO 52021-2	058.2000.020	250	8x1.0	10	9	21.5	16.0	1.5	1.980
* SO 52021-3	058.2000.030	250	8x1.0	10	9	22.0	16.0	2.5	1.970
SO 52021-4	058.2000.040	250	8x1.0	10	9	21.5	16.0	3.5	1.950
SO 52021-5	058.2000.050	250	8x1.0	10	9	22.0	16.0	3.5	1.900
SO 52021-6	058.2000.060	200	10x1.0	12	9	23.5	16.0	4.5	2.730
SO 52021-8	058.2000.080	200	12x1.0	14	10	27.0	18.0	6.5	3.740
SO 52021-10	058.2000.100	160	14x1.0	17	12	32.0	20.5	8.5	5.900
SO 52021-12	058.2000.120	160	16x1.0	19	14	34.0	21.5	9.5	7.530
* SO 52021-14	058.2000.140	100	20x1.5	24	17	38.5	24.5	12.0	13.150
SO 52021-15	058.2000.150	100	20x1.5	24	17	38.5	24.5	13.0	12.910
* SO 52021-16	058.2000.160	100	24x1.5	30	22	42.0	26.5	14.0	21.980
SO 52021-18	058.2000.180	100	24x1.5	30	22	42.0	26.5	15.0	21.430
SO 52021-22	058.2000.220	64	28x1.5	32	27	49.5	30.5	19.0	27.180
SO 52021-28	058.2000.280	40	36x2.0	41	36	62.5	43.0	24.0	76.000

Für Zollrohre	Pour tubes pouces			For inch tubes					
SO 52021-6,35	058.2000.063	200	10x1.0	12	9	24.0	16.0	4.5	2.690
SO 52021-9,52	058.2000.095	160	14x1.0	17	12	32.0	20.5	8.0	5.960
SO 52021-12,7	058.2000.127	160	20x1.5	24	17	38.0	24.5	11.0	13.790
* SO 52021-13,5	058.2000.135	100	20x1.5	24	17	38.5	24.5	12.0	13.250
* SO 52021-17,2	058.2000.172	100	24x1.5	30	22	42.0	26.5	15.0	21.680
* SO 52021-21,3	058.2000.213	64	28x1.5	32	27	49.5	30.5	19.0	28.580

Umrechnung für "d" bei Zollrohren:

6,35 = 1/4
 9,52 = 3/8
 12,7 = 1/2
 13,5 = 17/32
 17,2 = 11/16
 21,3 = 27/32

Conversion de "d" pour tubes en pouces:

6,35 = 1/4
 9,52 = 3/8
 12,7 = 1/2
 13,5 = 17/32
 17,2 = 11/16
 21,3 = 27/32

Conversion for "d" for inch tubes:

6,35 = 1/4
 9,52 = 3/8
 12,7 = 1/2
 13,5 = 17/32
 17,2 = 11/16
 21,3 = 27/32

d=Rohrassen-ø
 e= kleinste Bohrung
 L= Mass in montiertem Zustand
 *=mit reduziertem Klemmring

d=ø extérieur du tube
 e= ø-min. de passage
 L=après montage
 *=avec bague de serrage de réduction

d=tube outside diameter
 e=minimum bore
 L=installed length
 *=with reduction compression ferrule

Winkelverschraubung reduziert

Coude réduit

Elbow reduction union

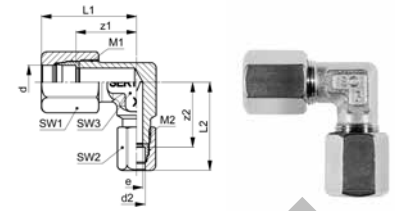

SO 52021 RED

Type -d-d2	Mat.-Nr.	bar	M1	M2	SW1	SW2	SW3	L1	L2	z1	z2	e	kg/100
Für metrische Rohre	Pour tubes métriques			For metric tubes									
* SO 52021-5-3	058.2004.060	250	8x1.0	8x1.0	10	10	9	22.0	22.0	16.0	16.0	2.5	1.830
* SO 52021-6-4	058.2004.110	200	10x1.0	10x1.0	12	12	9	24.0	24.0	16.0	16.0	3.5	2.820
* SO 52021-6-5	058.2004.117	200	10x1.0	10x1.0	12	12	9	24.0	24.0	16.0	16.0	4.0	2.780
* SO 52021-8-6	058.2004.140	200	12x1.0	12x1.0	14	14	10	26.5	26.5	18.0	18.0	4.5	3.900
* SO 52021-10-6	058.2004.175	160	16x1.0	10x1.0	19	12	14	34.0	31.5	21.5	23.0	4.5	7.500
* SO 52021-10-8	058.2004.190	160	14x1.0	14x1.0	17	17	12	32.0	32.0	21.0	21.0	6.5	6.090
SO 52021-12-6	058.2004.215	160	16x1.0	10x1.0	19	12	14	34.0	31.5	21.5	23.0	4.5	7.200
* SO 52021-12-10	058.2004.240	160	16x1.0	16x1.0	19	19	14	34.0	34.0	21.5	21.5	8.5	7.760
* SO 52021-15-12	058.2004.420	100	20x1.5	20x1.5	24	24	17	38.5	38.5	24.5	24.5	10.0	13.470
* SO 52021-15-14	058.2004.440	100	20x1.5	20x1.5	24	24	17	38.5	38.5	24.5	24.5	12.0	13.150
* SO 52021-18-15	058.2004.610	100	24x1.5	24x1.5	30	30	22	42.0	42.0	26.5	26.5	13.0	22.180
* SO 52021-18-16	058.2004.620	100	24x1.5	24x1.5	30	30	22	42.0	42.0	26.0	26.5	14.0	21.980
* SO 52021-22-18	058.2004.755	64	28x1.5	28x1.5	32	32	27	49.5	49.5	30.5	30.5	16.0	29.780

Für Zollrohre	Pour tubes pouces			For inch tubes									
SO 52021-6-6,35	058.2004.119	200	10x1.0	10x1.0	12	12	9	24.0	24.0	16.0	16.0	4.5	2.720
SO 52021-10-9,52	058.2004.197	160	14x1.0	14x1.0	17	17	12	32.0	32.0	20.5	20.5	8.0	5.930
SO 52021-15-12,7	058.2004.427	100	20x1.5	20x1.5	24	24	17	38.5	38.5	24.5	24.5	11.0	13.350
* SO 52021-15-13,5	058.2004.435	100	20x1.5	20x1.5	24	24	17	38.5	38.5	24.5	24.5	12.0	13.250
* SO 52021-18-17,2	058.2004.632	100	24x1.5	24x1.5	30	30	22	42.0	42.0	26.5	26.5	15.0	21.680
* SO 52021-22-21,3	058.2004.785	64	24x1.5	28x1.5	32	32	27	49.5	49.5	30.5	30.5	19.0	28.580

Umrechnung für "d" bei Zollrohren:

6,35 = 1/4
 9,52 = 3/8
 12,7 = 1/2
 13,5 = 17/32
 17,2 = 11/16
 21,3 = 27/32

Conversion de "d" pour tubes en pouces:

6,35 = 1/4
 9,52 = 3/8
 12,7 = 1/2
 13,5 = 17/32
 17,2 = 11/16
 21,3 = 27/32

Conversion for "d" for inch tubes:

6,35 = 1/4
 9,52 = 3/8
 12,7 = 1/2
 13,5 = 17/32
 17,2 = 11/16
 21,3 = 27/32

Weitere Reduktionen siehe SO 51821

Autres réductions voir SO 51821

Alternative reductions see SO 51821

d=Rohrassen-ø
 e= kleinste Bohrung
 L= Mass in montiertem Zustand
 *=mit reduziertem Klemmring

d=ø extérieur du tube
 e= ø-min. de passage
 L=après montage
 *=avec bague de serrage de réduction

d=tube outside diameter
 e=minimum bore
 L=installed length
 *=with reduction compression ferrule

Winkelverschraubung

mit Übergangsnippel SO 50040

Coude

avec adaptateur mâle SO 50040

Elbow union

with male adaptor SO 50040

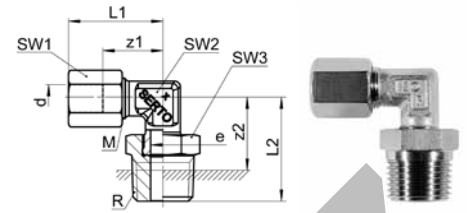

SO 52121

Type -d-R	Mat.-Nr.	bar	M	SW1	SW2	SW3	L1	L2	z1	z2	e	kg/100
Für metrische Rohre	Pour tubes métriques						For metric tubes					
R=Rohrgewinde (kegelig)	R=Filetage-gaz BSP (conique)						R=BSP thread (tapered)					
SO 52121-6-1/8	058.2101.100	200	10x1.0	12	9	12	24.0	26.0	16.0	21.0	4.5	2.740
SO 52121-6-1/4	058.2101.110	200	10x1.0	12	9	14	24.0	30.0	16.0	22.0	4.5	3.710
SO 52121-8-1/8	058.2101.160	200	12x1.0	14	10	14	26.5	28.0	18.0	24.0	6.5	3.670
SO 52121-8-3/8	058.2101.180	200	12x1.0	14	10	17	26.5	32.0	18.0	24.0	6.5	5.640
SO 52121-10-1/8	058.2101.265	160	14x1.0	17	12	17	32.0	31.0	20.5	26.0	6.0	5.300
SO 52121-10-3/8	058.2101.280	160	14x1.0	17	12	17	32.0	34.5	20.5	26.5	8.5	6.300
SO 52121-10-1/2	058.2101.285	160	14x1.0	17	12	22	32.0	35.5	20.5	27.5	8.5	8.730
SO 52121-12-1/4	058.2101.380	160	16x1.0	19	14	19	34.0	36.5	21.5	28.5	8.5	7.230
SO 52121-12-1/2	058.2101.400	160	16x1.0	19	14	22	34.0	39.5	21.5	29.5	9.5	10.100
SO 52121-15-3/8	058.2101.532	100	20x1.5	24	17	24	38.5	39.0	24.5	31.0	10.5	13.900
* SO 52121-16-1/2	058.2101.566	100	24x1.5	30	22	30	42.0	46.0	26.5	38.0	13.5	21.060
SO 52121-18-1/2	058.2101.646	100	24x1.5	30	22	30	42.0	46.0	26.5	38.0	13.5	20.510
SO 52121-18-3/4	058.2101.648	100	24x1.5	30	22	30	42.0	46.5	26.5	37.0	15.0	26.300
SO 52121-22-3/4	058.2101.768	64	28x1.5	32	27	36	49.5	50.5	30.5	41.0	19.0	29.640
Für Zollrohre	Pour tubes pouces						For inch tubes					
SO 52121-9,52-1/2	058.2101.240	160	14x1.0	17	12	22	32.0	35.5	20.5	27.5	8.5	8.760
* SO 52121-17,2-1/2	058.2101.616	100	24x1.5	30	22	30	42.0	46.0	26.5	38.0	13.5	20.760
* SO 52121-21,3-3/4	058.2101.738	64	28x1.5	32	27	36	49.5	50.5	30.5	41.0	19.0	29.640

Umrechnung für "d" bei Zollrohren:

9,52 = 3/8
17,2 = 11/16
21,3 = 27/32

Conversion de "d" pour tubes en pouces:

9,52 = 3/8
17,2 = 11/16
21,3 = 27/32

Conversion for "d" for inch tubes:

9,52 = 3/8
17,2 = 11/16
21,3 = 27/32

Montagehinweis: Nippel ist handfest montiert. Bei Endmontage mit 1/4 Umdrehung anziehen.
Wir empfehlen eine zusätzliche Schmierung auf der Planfläche.

Note d'installation: L'adaptateur femelle-mâle est monté serré à la main. Pour le montage final, serrer avec 1/4 de tour.
Nous recommandons une lubrification supplémentaire sur la surface plane.

Assembly information: Male adaptor is mounted finger-tight. For final assembly, tighten with 1/4 turn.
We recommend additional lubrication on the plane surface.

d=Rohrtaussendungs-Ø
e=kleinste Bohrung
L=Mass in montiertem Zustand
*=mit reduziertem Klemmring

d=Ø extérieur du tube
e=Ø-min. de passage
L=après montage
*=avec bague de serrage de réduction

d=tube outside diameter
e=minimum bore
L=installed length
*=with reduction compression ferrule

Winkelverschraubung

mit Übergangsnippel SO 50040 NPT

Coûde

avec adaptateur mâle SO 50040 NPT

Elbow union

with male adaptor SO 50040 NPT

SO 52121 NPT

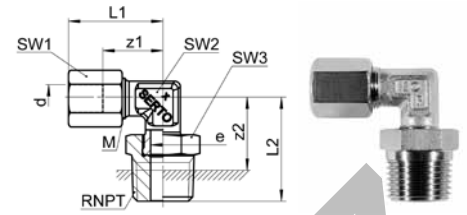

Type -d -RNPT	Mat.-Nr.	bar	M	SW1	SW2	SW3	L1	L2	z1	z2	e	kg/100
RNPT=NPT Gewinde												

Winkelverschraubung

mit Übergangsnippel SO 50040 METR

Coûde

avec adaptateur mâle SO 50040 METR

Elbow union

with male adaptor SO 50040 METR

SO 52121 METR

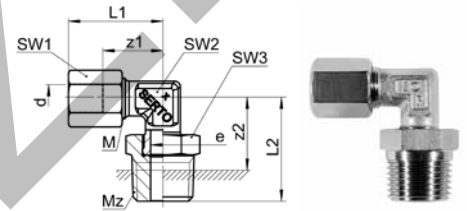

Type -d -Mz	Mat.-Nr.	bar	M	SW1	SW2	SW3	L1	L2	z1	z2	e	kg/100
Mz=metrisches Gewinde (zylindrisch)												

Montagehinweis: Nippel ist handfest montiert. Bei Endmontage mit 1/4 Umdrehung anziehen.

Wir empfehlen eine zusätzliche Schmierung auf der Planfläche.

Note d'installation: L'adaptateur femelle-mâle est monté serré à la main. Pour le montage final, serrer avec 1/4 de tour.

Nous recommandons une lubrification supplémentaire sur la surface plane.

Assembly information: Male adaptor is mounted finger-tight. For final assembly, tighten with 1/4 turn.

We recommend additional lubrication on the plane surface.

d=Rohrassen-ø
e=kleinste Bohrung
L=Mass in montiertem Zustand
*=mit reduziertem Klemmring

d=ø extérieur du tube
e=ø-min. de passage
L=après montage
*=avec bague de serrage de réduction

d=tube outside diameter
e=minimum bore
L=installed length
*=with reduction compression ferrule

Winkelverschraubung

mit Übergangsmuffe SO 50030

Coûde

avec adaptateur femelle SO 50030

Elbow union

with female adaptor SO 50030

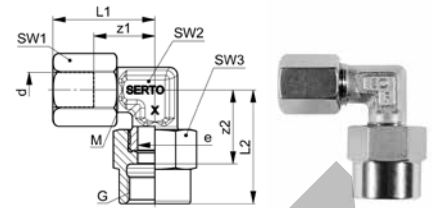

SO 52221

Type -d-G	Mat.-Nr.	bar	M	SW1	SW2	SW3	L1	L2	z1	z2	e	kg/100
Für metrische Rohre	Pour tubes métriques						For metric tubes					
G=Rohrgewinde (zylindrisch)	G=Filetage-gaz BSP (cylindrique)						G=BSP thread (parallel)					
* SO 52221-4-1/8	058.2201.060	200	10x1.0	12	9	14	24.0	29.0	16.0	19.0	3.5	3.500
* SO 52221-4-1/4	058.2201.065	200	10x1.0	12	9	17	24.0	30.0	16.0	19.0	3.5	3.590
* SO 52221-5-1/8	058.2201.082	200	10x1.0	12	9	14	24.0	29.0	16.0	19.0	4.0	3.470
SO 52221-6-1/8	058.2201.100	200	10x1.0	12	9	14	24.0	29.0	16.0	19.0	4.5	3.420
SO 52221-6-1/4	058.2201.110	200	10x1.0	12	9	17	24.0	30.0	16.0	19.0	4.5	4.680
SO 52221-6-3/8	058.2201.120	200	10x1.0	12	9	22	24.0	31.0	16.0	19.0	4.5	4.900
SO 52221-8-1/8	058.2201.160	200	12x1.0	14	10	17	26.5	31.0	18.0	21.0	6.5	5.250
SO 52221-8-1/4	058.2201.170	200	12x1.0	14	10	17	26.5	33.0	18.0	22.0	6.5	4.840
SO 52221-8-3/8	058.2201.180	200	12x1.0	14	10	22	26.5	35.0	20.0	23.0	6.5	7.616
SO 52221-10-1/4	058.2201.270	160	14x1.0	17	12	17	32.0	34.5	20.5	23.5	8.5	5.990
SO 52221-10-3/8	058.2201.280	160	14x1.0	17	12	22	32.0	35.5	20.5	23.5	8.5	8.170
SO 52221-12-1/4	058.2201.380	160	16x1.0	19	14	19	34.0	35.5	21.5	24.5	8.5	9.020
SO 52221-12-3/8	058.2201.390	160	16x1.0	19	14	22	34.0	36.5	21.5	24.5	9.5	9.040
SO 52221-12-1/2	058.2201.400	160	16x1.0	19	14	27	34.0	40.0	23.0	26.0	10.0	12.580
SO 52221-15-1/4	058.2201.528	100	20x1.5	24	17	24	38.5	35.5	24.5	26.5	13.0	11.900
SO 52221-15-3/8	058.2201.532	100	20x1.5	24	17	24	38.5	40.5	24.5	28.5	13.0	12.700
SO 52221-15-1/2	058.2201.534	100	20x1.5	24	17	27	38.5	42.0	24.5	28.0	13.0	15.300
* SO 52221-16-1/2	058.2201.566	100	24x1.5	30	22	30	42.0	45.0	26.5	31.0	14.0	23.850
SO 52221-18-1/2	058.2201.646	100	24x1.5	30	22	30	42.0	45.0	26.5	31.0	15.0	23.300

Für Zollrohre

Pour tubes pouces

For inch tubes

SO 52221-6,35-1/8	058.2201.135	200	10x1.0	12	9	14	24.0	29.0	16.0	19.0	4.5	3.400
SO 52221-9,52-1/4	058.2201.230	160	14x1.0	17	12	17	32.0	35.5	20.5	23.5	8.0	6.020
SO 52221-9,52-3/8	058.2201.235	160	14x1.0	17	12	22	32.0	35.5	20.5	23.5	8.0	8.200
* SO 52221-17,2-1/2	058.2201.616	100	24x1.5	30	22	30	42.0	45.0	26.5	31.0	15.0	23.460

Umrechnung für "d" bei Zollrohren:

6,35 = 1/4
 9,52 = 3/8
 17,2 = 11/16

Conversion de "d" pour tubes en pouces:

6,35 = 1/4
 9,52 = 3/8
 17,2 = 11/16

Conversion for "d" for inch tubes:

6,35 = 1/4
 9,52 = 3/8
 17,2 = 11/16

Montagehinweis: Muffe ist handfest montiert. Bei Endmontage mit 1/4 Umdrehung anziehen.

Wir empfehlen eine zusätzliche Schmierung auf der Planfläche.

Note d'installation: L'adaptateur femelle est monté serré à la main. Pour le montage final, serrer avec 1/4 de tour.

Nous recommandons une lubrification supplémentaire sur la surface plane.

Assembly information: Female adaptor is mounted finger-tight. For final assembly, tighten with 1/4 turn.

We recommend additional lubrication on the plane surface.

d=Rohrassen-ø
 e=kleinste Bohrung
 L=Mass in montiertem Zustand
 *=mit reduziertem Klemmring

d=ø extérieur du tube
 e=ø-min. de passage
 L=après montage
 *=avec bague de serrage de réduction

d=tube outside diameter
 e=minimum bore
 L=installed length
 *=with reduction compression ferrule

Winkel-Einschraubverschraubung

Coude mâle

Male adaptor elbow union

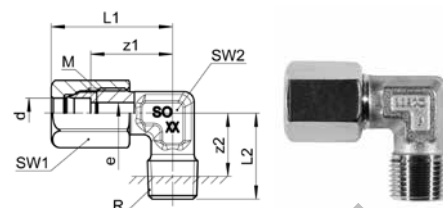

SO 52421

Type -d -R	Mat.-Nr.	bar	M	SW1	SW2	L1	L2	z1	z2	e	kg/100
Für metrische Rohre R=Rohrgewinde (kegelig)	Pour tubes métriques R=Filetage-gaz BSP (conique)	For metric tubes R=BSP thread (tapered)									
* SO 52421-2-1/8	058.2401.020	250	8x1.0	10	9	21.5	17.0	16.0	13.0	1.5	1.740
* SO 52421-3-1/8	058.2401.040	250	8x1.0	10	9	22.0	17.0	16.0	13.0	2.5	1.700
SO 52421-4-1/8	058.2401.060	250	8x1.0	10	9	21.5	17.0	16.0	13.0	3.5	1.620
SO 52421-5-1/8	058.2401.082	250	8x1.0	10	9	22.0	17.0	16.0	13.0	3.5	1.600
SO 52421-6-1/8	058.2401.100	200	10x1.0	12	9	24.0	17.0	16.0	13.0	4.5	2.090
SO 52421-6-1/4	058.2401.110	200	10x1.0	12	10	26.0	22.5	18.0	18.5	4.5	3.410
SO 52421-8-1/8	058.2401.160	200	12x1.0	14	10	26.5	18.0	18.0	13.5	6.0	2.670
SO 52421-8-1/4	058.2401.170	200	12x1.0	14	10	26.5	22.5	18.0	18.5	6.5	3.250
SO 52421-8-3/8	058.2401.180	200	12x1.0	14	14	30.5	26.0	22.0	19.5	6.5	5.510
SO 52421-10-1/4	058.2401.270	160	14x1.0	17	12	32.0	25.0	20.5	19.0	8.5	4.220
* SO 52421-10-3/8	058.2401.280	160	16x1.0	19	14	34.0	26.0	21.5	19.5	8.5	6.110
SO 52421-12-1/4	058.2401.380	160	16x1.0	19	14	33.5	25.4	21.5	19.0	8.5	5.120
SO 52421-12-3/8	058.2401.390	160	16x1.0	19	14	33.5	26.0	21.5	19.5	10.0	5.910
* SO 52421-12-1/2	058.2401.400	100	20x1.5	24	17	38.0	29.5	24.0	21.5	10.0	10.240
* SO 52421-14-1/2	058.2401.504	100	20x1.5	24	17	38.5	29.5	24.5	21.5	12.0	9.920
SO 52421-15-1/2	058.2401.534	100	20x1.5	24	17	38.5	29.5	24.5	21.5	13.0	9.680
SO 52421-18-1/2	058.2401.646	100	24x1.5	30	24	49.0	35.0	33.5	27.0	15.0	19.990
SO 52421-22-3/4	058.2401.768	64	28x1.5	32	27	56.5	45.0	37.5	35.5	19.0	27.200
SO 52421-28-1	058.2401.850	40	36x2.0	41	36	57.5	45.0	38.0	29.0	24.0	51.000

Für Zollrohre

Pour tubes pouces

For inch tubes

SO 52421-6,35-1/8	058.2401.135	200	10x1.0	12	9	24.0	17.0	16.0	13.0	4.5	2.000
* SO 52421-6,35-1/4	058.2401.140	200	12x1.0	14	10	26.5	22.5	18.0	18.5	4.5	3.400
SO 52421-9,52-1/4	058.2401.230	160	14x1.0	17	12	32.0	25.0	20.5	19.0	8.0	4.250
SO 52421-12,7-1/2	058.2401.434	160	20x1.5	24	17	38.0	29.5	24.5	21.5	11.0	10.120
* SO 52421-13,5-1/2	058.2401.474	100	20x1.5	24	17	38.5	29.5	24.5	21.5	12.0	10.020

Umrechnung für "d" bei Zollrohren:

6,35 = 1/4
 9,52 = 3/8
 12,7 = 1/2
 13,5 = 17/32

Conversion de "d" pour tubes en pouces:

6,35 = 1/4
 9,52 = 3/8
 12,7 = 1/2
 13,5 = 17/32

Conversion for "d" for inch tubes:

6,35 = 1/4
 9,52 = 3/8
 12,7 = 1/2
 13,5 = 17/32

Weitere Einschraubwinkel siehe SO 52121

Autres coudes mâles voir SO 52121

Alternative elbow unions see SO 52121

d=Rohraussen-ø
 e=kleinste Bohrung
 L=Mass in montiertem Zustand
 *=mit reduziertem Klemmring

d=ø extérieur du tube
 e=ø-min. de passage
 L=après montage
 *=avec bague de serrage de réduction

d=tube outside diameter
 e=minimum bore
 L=installed length
 *=with reduction compression ferrule

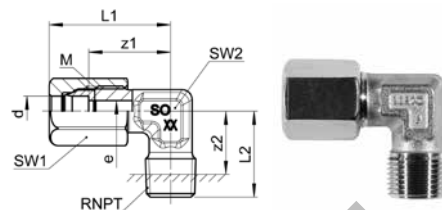
Winkel-Einschraubverschraubung NPT
Coude mâle NPT
Male adaptor elbow union NPT

SO 52421 NPT

Type -d -RNPT	Mat.-Nr.	bar	M	SW1	SW2	L1	L2	z1	z2	e	kg/100
Für metrische Rohre RNPT=NPT Gewinde	Pour tubes métriques RNPT=Filetage NPT										
For metric tubes RNPT=NPT thread											
★ SO 52421-3-1/8 NPT	058.2402.040	250	8x1.0	10	9	22.0	17.0	16.0	13.0	2.5	1.530
SO 52421-4-1/8 NPT	058.2402.060	250	8x1.0	10	9	21.5	17.0	16.0	13.0	3.5	1.460
SO 52421-5-1/8 NPT	058.2402.082	250	8x1.0	10	9	22.0	17.0	16.0	13.0	3.5	1.440
SO 52421-6-1/8 NPT	058.2402.100	200	10x1.0	12	9	24.0	17.0	16.0	13.0	4.5	1.900
★ SO 52421-6-1/4 NPT	058.2402.110	200	12x1.0	14	10	27.0	22.5	18.5	18.5	4.5	3.330
SO 52421-8-1/4 NPT	058.2402.170	200	12x1.0	14	10	26.5	22.5	18.0	18.5	6.5	3.170
SO 52421-10-1/4 NPT	058.2402.270	160	14x1.0	17	12	32.0	25.0	20.5	19.0	8.5	4.280
★ SO 52421-10-3/8 NPT	058.2402.280	160	16x1.0	19	14	34.0	26.0	21.5	20.0	8.5	6.060
SO 52421-12-3/8 NPT	058.2402.390	160	16x1.0	19	14	33.5	26.0	21.5	20.0	10.0	5.860
★ SO 52421-12-1/2 NPT	058.2402.400	100	20x1.5	24	17	38.0	29.5	24.0	21.5	10.0	10.130
★ SO 52421-14-1/2 NPT	058.2402.504	100	20x1.5	24	17	38.5	29.5	24.5	21.5	12.0	9.810
SO 52421-15-1/2 NPT	058.2402.534	100	20x1.5	24	17	38.5	29.5	24.5	21.5	13.0	9.570

Für Zollrohre

Pour tubes pouces

For inch tubes

SO 52421-6,35-1/8 NPT	058.2402.135	200	10x1.0	12	9	24.0	17.0	16.0	13.0	4.5	1.880
★ SO 52421-6,35-1/4 NPT	058.2402.140	200	12x1.0	14	10	26.5	22.5	18.0	18.5	4.5	3.300
SO 52421-9,52-1/4 NPT	058.2402.230	160	14x1.0	17	12	32.0	25.0	20.5	19.0	8.0	4.310
SO 52421-12,7-1/2 NPT	058.2402.434	160	20x1.5	24	17	38.0	29.5	24.5	21.5	11.0	10.010
★ SO 52421-13,5-1/2 NPT	058.2402.474	100	20x1.5	24	17	38.5	29.5	24.5	21.5	12.0	9.910

Umrechnung für "d" bei Zollrohren:

6,35 = 1/4
 9,52 = 3/8
 12,7 = 1/2
 13,5 = 17/32

Conversion de "d" pour tubes en pouces:

6,35 = 1/4
 9,52 = 3/8
 12,7 = 1/2
 13,5 = 17/32

Conversion for "d" for inch tubes:

6,35 = 1/4
 9,52 = 3/8
 12,7 = 1/2
 13,5 = 17/32

Weitere Einschraubwinkel siehe SO 52121

Autres coudes mâles voir SO 52121

Alternative elbow union see SO 52121

Einstellbare Winkelverschraubung

Coude orientable

Adjustable elbow union

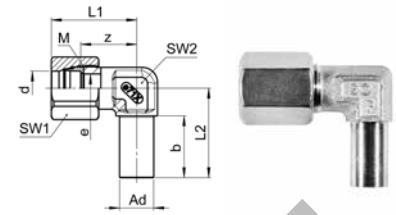

SO 52621

Type -d -Ad	Mat.-Nr.	bar	M	SW1	SW2	L1	L2	b	z	e	kg/100	
Für metrische Rohre	Pour tubes métriques			For metric tubes								
* SO 52621-4-A6	058.2600.045	200	10x1.0	12	9	24.0	18.0	12.5	16.0	3.5	1.780	
* SO 52621-5-A6	058.2600.053	200	10x1.0	12	9	24.0	18.0	12.5	16.0	4.0	1.760	
SO 52621-6-A6	058.2600.060	200	10x1.0	12	9	24.0	18.0	12.5	16.0	4.0	1.710	
* SO 52621-6-A8	058.2600.063	200	12x1.0	14	10	27.0	23.0	15.0	18.5	4.5	2.630	
SO 52621-8-A8	058.2600.080	200	12x1.0	14	10	26.5	23.0	15.0	18.0	6.0	2.430	
* SO 52621-8-A10	058.2600.083	160	14x1.0	17	12	32.0	25.5	17.0	21.0	6.5	4.050	
SO 52621-10-A10	058.2600.100	160	14x1.0	17	12	32.0	25.5	17.0	20.5	7.0	3.880	
SO 52621-12-A12	058.2600.120	160	16x1.0	19	14	33.5	26.5	18.0	21.5	9.0	5.500	
SO 52621-15-A15	058.2600.150	100	20x1.5	24	17	38.5	30.0	19.5	24.5	12.0	9.800	
SO 52621-18-A18	058.2600.180	100	24x1.5	30	24	45.0	47.0	25.0	29.5	15.0	9.290	
Für Zollrohre	Pour tubes pouces			For inch tubes								
SO 52621-6,35-A6	058.2600.067	200	10x1.0	12	9	24.0	18.0	12.5	16.0	4.0	1.710	

Umrechnung für "d" bei Zollrohren:
6,35 = 1/4

Conversion de "d" pour tubes en pouces:
6,35 = 1/4

Conversion for "d" for inch tubes:
6,35 = 1/4

5

Anwendungsbeispiele:

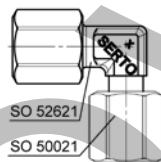

Exemples d'utilisation:

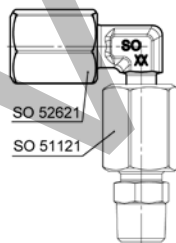

Sample combinations:

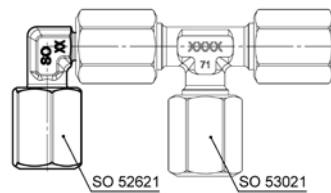

Mögliche Kombinationen:

- mit Armaturenanschluss zu einstellbaren Winkelverschraubungen
- mit Verschraubungen zu einstellbaren Verschraubungen
- mit Einschraubverschraubungen zu einstellbaren Einschraubwinkeln. Gegenüber dem Einschraubwinkel lässt sich diese Kombination einfacher einstellen, da Einschrauben und Ausrichten getrennt voneinander vorgenommen werden.

Combinaisons possibles:

- avec écrou de raccordement ça donne des raccords coudé orientables
- avec raccords ça donne des raccords orientables
- avec une union mâle ça donne un coude fileté orientable. Par rapport au coude orientable, cette combinaison est facile à régler, puisque le vissage et l'alignement sont réalisés séparément l'un de l'autre.

Possible combinations:

- with nut connections to adjustable elbow unions
- with unions to adjustable unions
- with male adaptor unions to adjustable male adaptor elbow unions. This combination is simpler to produce, as screwing in and alignment are carried out separately.

d=Rohrassens-ø
Ad=Aussen-ø der Drehung
e=kleinste Bohrung
L=Mass in montiertem Zustand
*=mit reduziertem Klemmring

d=ø extérieur du tube
Ad=ø extérieur de la portée cylindrique
e=ø-min. de passage
L=après montage
*=avec bague de serrage de réduction

d=tube outside diameter
Ad=outside diameter of cyl. stub
e=minimum bore
L=installed length
*=with reduction compression ferrule

Einstellbare Winkelverschraubung vormontiert

Coude orientable prémonté

Adjustable elbow union pre-assembled

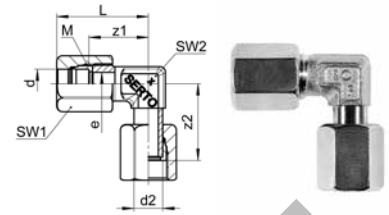
SO 52625

Type -d -d2	Mat.-Nr.	bar	M	SW1	SW2	L	z1	z2	e	kg/100	
Für metrische Rohre	Pour tubes métriques			For metric tubes							
* SO 52625-4-A6	058.2620.045	200	10x1.0	12	9	24.0	16.0	19.0	3.5	2.570	
* SO 52625-5-A6	058.2620.053	200	10x1.0	12	9	24.0	16.0	19.0	4.0	2.550	
SO 52625-6-A6	058.2620.060	200	10x1.0	12	9	24.0	16.0	19.0	4.0	2.500	
* SO 52625-6-A8	058.2620.063	200	12x1.0	14	10	27.0	18.5	24.0	4.5	3.800	
SO 52625-8-A8	058.2620.080	200	12x1.0	14	10	26.5	18.0	24.0	6.0	3.480	
* SO 52625-8-A10	058.2620.083	160	14x1.0	17	12	32.0	20.5	26.5	6.5	5.830	
SO 52625-10-A10	058.2620.100	160	14x1.0	17	12	32.0	20.5	26.5	7.0	5.660	
SO 52625-12-A12	058.2620.120	160	16x1.0	19	14	33.5	21.5	27.5	9.0	7.280	
SO 52625-15-A15	058.2620.150	100	20x1.5	24	17	38.5	24.5	31.5	12.0	8.040	
SO 52625-18-A18	058.2620.180	100	24x1.5	30	24	45.0	29.5	48.5	15.0	17.300	
Für Zollrohre	Pour tubes pouces			For inch tubes							
SO 52625-6,35-A6	058.2620.067	200	10x1.0	12	9	24.0	16.0	19.0	4.0	2.500	

Umrechnung für "d" bei Zollrohren:
6,35 = 1/4

Conversion de "d" pour tubes en pouces:
6,35 = 1/4

Conversion for "d" for inch tubes:
6,35 = 1/4

Montagehinweis: Anschlussmutter auf Seite Einstellteil mit 1/4 Umdrehung anziehen. Wir empfehlen eine zusätzliche Schmierung auf der Planfläche.

Note d'installation: Serrez l'écrou du côté orientable de 1/4 de tour. Nous recommandons une lubrification supplémentaire sur la surface plane.

Assembly information: Tighten the union nut on the adjustable side with 1/4 turn. We recommend additional lubrication on the plane surface.

d=Rohraussen-ø
Ad=Aussen-ø der Andrehung
e=kleinste Bohrung
L=Mass in montiertem Zustand
*=mit reduziertem Klemmring

d=ø extérieur du tube
Ad=ø extérieur de la portée cylindrique
e=ø-min. de passage
L=après montage
*=avec bague de serrage de réduction

d=tube outside diameter
Ad=outside diameter of cyl. stub
e=minimum bore
L=installed length
*=with reduction compression ferrule

Winkel-Schottverschraubung

Durchführungslänge max. 20 mm

Coude traversée de cloison

pour cloison max. 20 mm

Panel mount elbow union

max. panel thickness 20 mm

SO 52721

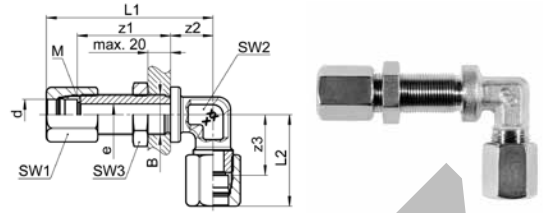

Type -d	Mat.-Nr.	bar	M	SW1	SW2	SW3	L1	L2	B	z1	z2	z3	e	kg/100
SO 52721-6	058.2700.060	200	10x1.0	12	12	14	57.0	27.0	10.5	36.0	13.0	19.0	4.5	6.980
SO 52721-8	058.2700.080	200	12x1.0	14	12	17	57.5	27.5	12.5	36.0	13.0	19.0	5.5	9.450
SO 52721-10	058.2700.100	160	14x1.0	17	12	19	64.5	34.5	14.5	36.0	17.0	23.0	7.5	12.350
SO 52721-12	058.2700.120	160	16x1.0	19	14	22	66.0	36.0	16.5	37.0	17.0	24.0	8.5	17.060
SO 52721-15	058.2700.150	100	20x1.5	24	19	27	77.5	43.5	20.5	40.5	23.0	29.5	13.0	28.600
SO 52721-18	058.2700.180	100	24x1.5	30	24	30	80.0	49.0	24.5	42.5	22.0	33.5	15.0	34.380
SO 52721-22	058.2700.220	64	28x1.5	32	27	36	94.5	56.5	28.5	46.5	29.0	37.5	19.0	31.800

Sechskantmutter siehe SO 50006 METR

Ecrou à six pans voir SO 50006 METR

Hexagon nut see SO 50006 METR

Schwenkverschraubung

Coude banjo

Single banjo

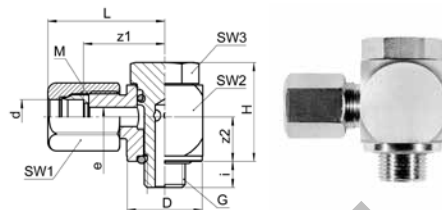
SO 52824

Type - d - G	Mat.-Nr.	bar	M	SW1	SW2	SW3	L	D	H	i	z1	z2	e	kg/100
Für metrische Rohre G=Rohrgewinde (zylindrisch)														
★ SO 52824-4-1/8	058.2841.060	200	10x1.0	12	16	14	26.0	18.0	23.0	6.5	18.0	10.5	4.5	5.000
★ SO 52824-5-1/8	058.2841.082	200	10x1.0	12	16	14	26.0	18.0	23.0	6.5	18.0	10.5	4.5	4.950
SO 52824-6-1/8	058.2841.100	200	10x1.0	12	16	14	26.0	18.0	23.0	6.5	18.0	10.5	4.5	4.900
★ SO 52824-6-1/4	058.2841.110	200	12x1.0	14	24	19	29.5	21.0	27.5	8.5	21.0	12.0	6.5	10.100
SO 52824-8-1/8	058.2841.160	200	12x1.0	14	19	14	27.5	18.0	23.0	6.5	19.0	10.5	4.5	6.300
SO 52824-8-1/4	058.2841.170	200	12x1.0	14	24	19	29.5	21.0	27.5	8.5	21.0	12.0	6.5	9.950
SO 52824-10-1/4	058.2841.270	160	14x1.0	17	24	19	32.0	21.0	27.5	8.5	20.5	12.0	8.5	10.800
★ SO 52824-10-3/8	058.2841.280	160	16x1.0	19	30	24	36.5	28.0	37.5	9.5	24.0	15.0	10.5	17.200
SO 52824-12-3/8	058.2841.390	160	16x1.0	19	30	24	36.0	28.0	37.5	9.5	24.0	15.0	10.5	16.800
★ SO 52824-12-1/2	058.2841.400	100	20x1.5	24	35	27	42.0	32.0	43.5	11.0	28.0	18.0	13.0	32.200
★ SO 52824-14-1/2	058.2841.504	100	20x1.5	24	35	27	42.5	32.0	43.5	11.0	28.5	18.0	13.0	31.800
SO 52824-15-1/2	058.2841.534	100	20x1.5	24	35	27	42.5	32.0	43.5	11.0	28.5	18.0	13.0	31.600
SO 52824-18-1/2	058.2841.646	100	24x1.5	30	35	27	44.0	32.0	43.5	11.0	28.5	18.0	13.0	34.690

Für Zollrohre

Pour tubes pouces

For inch tubes

SO 52824-6,35-1/8	058.2841.135	200	10x1.0	12	16	14	26.0	18.0	23.0	6.5	18.0	10.5	4.5	4.900
SO 52824-9,52-1/4	058.2841.230	160	14x1.0	17	24	19	32.0	21.0	27.5	8.5	20.5	12.0	8.5	10.800
SO 52824-12,7-1/2	058.2841.434	160	20x1.5	24	35	27	42.0	32.0	43.5	11.0	28.5	18.0	13.0	32.000

Umrechnung für "d" bei Zollrohren:

6,35 = 1/4
9,52 = 3/8
12,7 = 1/2

Conversion de "d" pour tubes en pouces:

6,35 = 1/4
9,52 = 3/8
12,7 = 1/2

Conversion for "d" for inch tubes:

6,35 = 1/4
9,52 = 3/8
12,7 = 1/2

O-Ringe: FKM

Joints: FKM

O-Rings: FKM

Schwenkverschraubung METR

Coude banjo METR

Single banjo METR

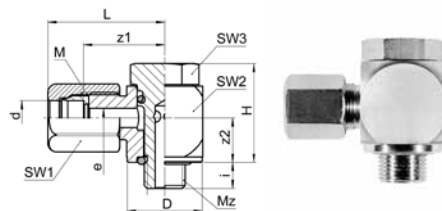
SO 52824 METR

Type - d - Mz	Mat.-Nr.	bar	M	SW1	SW2	SW3	L	D	H	i	z1	z2	e	kg/100
Mz=metrisches Gewinde (zylindrisch)														
★ SO 52824-3-M5	058.2843.050	250	8x1.0	10	12	10	22.0	12.0	15.0	5.5	15.0	6.0	3.5	2.250
SO 52824-4-M5	058.2843.080	250	8x1.0	10	12	10	21.5	12.0	15.0	5.5	15.0	6.0	3.5	2.170
SO 52824-5-M5	058.2843.110	250	8x1.0	10	12	10	22.0	12.0	15.0	5.5	15.0	6.0	3.5	2.180
SO 52824-10-M12x1,5	058.2843.275	160	14x1.0	17	24	19	32.0	21.0	27.5	8.5	20.5	12.0	8.5	11.600
SO 52824-18-M22x1,5	058.2843.646	100	24x1.5	30	35	27	44.0	32.0	43.5	11.0	28.5	18.0	13.0	35.000

O-Ringe: FKM

Joints: FKM

O-Rings: FKM

d=Rohrassen-ø
e=kleinste Bohrung
L=Mass in montiertem Zustand
*=mit reduziertem Klemmring

d=ø extérieur du tube
e=ø-min. de passage
L=après montage
*=avec bague de serrage de réduction

d=tube outside diameter
e=minimum bore
L=installed length
*=with reduction compression ferrule

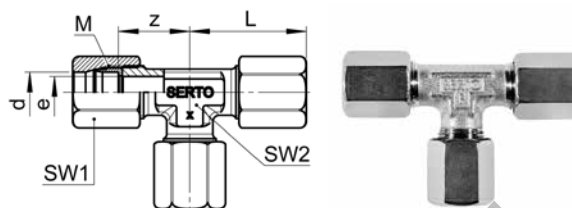
T-Verschraubung
Té égal
Tee union
SO 53021

Type-d	Mat.-Nr.	bar	M	SW1	SW2	L	z	e	kg/100
Für metrische Rohre	Pour tubes métriques			For metric tubes					
SO 53021-2	058.3000.020	250	6x0.75	8	9	19.0	15.5	1.5	1.730
SO 53021-3	058.3000.030	250	6x0.75	8	9	21.0	16.0	2.5	1.850
SO 53021-4	058.3000.040	250	8x1.0	10	9	21.5	16.0	3.5	2.810
SO 53021-5	058.3000.050	250	8x1.0	10	9	22.0	16.0	3.5	2.750
SO 53021-6	058.3000.060	200	10x1.0	12	9	24.0	16.0	4.5	3.990
SO 53021-8	058.3000.080	200	12x1.0	14	10	26.5	18.0	6.5	5.340
SO 53021-10	058.3000.100	160	14x1.0	17	12	32.0	20.5	8.5	8.450
SO 53021-12	058.3000.120	160	16x1.0	19	14	33.5	21.5	9.5	10.700
* SO 53021-14	058.3000.140	100	20x1.5	24	17	38.5	24.5	12.0	18.890
SO 53021-15	058.3000.150	100	20x1.5	24	17	38.5	24.5	13.0	18.650
* SO 53021-16	058.3000.160	100	24x1.5	30	22	42.0	26.5	14.0	31.060
SO 53021-18	058.3000.180	100	24x1.5	30	22	42.0	26.5	15.0	30.510
SO 53021-22	058.3000.220	64	28x1.5	32	27	49.5	30.5	19.0	38.280
SO 53021-28	058.3000.280	64	36x2.0	41	36	62.5	43.0	24.0	93.700

Für Zollrohre	Pour tubes pouces			For inch tubes					
SO 53021-3,2	058.3000.032	250	6x0.75	8	9	21.0	16.0	2.5	1.650
SO 53021-6,35	058.3000.063	200	10x1.0	12	9	24.0	16.0	4.5	3.930
SO 53021-9,52	058.3000.095	160	14x1.0	17	12	32.0	20.5	8.0	8.540
SO 53021-12,7	058.3000.127	160	20x1.5	24	17	38.0	24.5	11.0	19.970
* SO 53021-13,5	058.3000.135	100	20x1.5	24	17	38.5	24.5	12.0	18.990
* SO 53021-17,2	058.3000.172	100	24x1.5	30	22	42.0	26.5	15.0	30.660
* SO 53021-21,3	058.3000.213	64	28x1.5	32	27	50.0	31.0	19.0	39.680

Umrechnung für "d" bei Zollrohren:

6,35 = 1/4
 9,52 = 3/8
 12,7 = 1/2
 13,5 = 17/32
 17,2 = 11/16
 21,3 = 27/32

Conversion de "d" pour tubes en pouces:

6,35 = 1/4
 9,52 = 3/8
 12,7 = 1/2
 13,5 = 17/32
 17,2 = 11/16
 21,3 = 27/32

Conversion for "d" for inch tubes:

6,35 = 1/4
 9,52 = 3/8
 12,7 = 1/2
 13,5 = 17/32
 17,2 = 11/16
 21,3 = 27/32

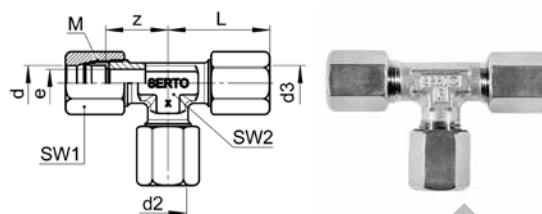
T-Verschraubung reduziert
Té réduit
Tee reduction union

SO 53021 RED

Type -d -d2 -d3	Mat.-Nr.	bar	M	SW1	SW2	L	z	e	kg/100
SO 53021-2-3-2	058.3004.010	250	6x0.75	8	9	21.0	16.0	1.5	1.580
SO 53021-2-3-3	058.3004.012	250	6x0.75	8	9	21.0	16.0	1.5	1.600
SO 53021-3-2-2	058.3004.015	250	6x0.75	8	9	21.0	16.0	1.5	1.580
* SO 53021-3-5-3	058.3004.020	250	8x1.0	10	9	22.0	16.0	2.5	2.690
* SO 53021-4-6-4	058.3004.025	200	10x1.0	12	9	24.0	16.0	3.5	4.130
* SO 53021-5-3-3	058.3004.030	250	8x1.0	10	9	22.0	16.0	2.5	2.690
* SO 53021-5-3-5	058.3004.034	250	8x1.0	10	9	22.0	16.0	2.5	2.620
* SO 53021-5-5-3	058.3004.038	250	8x1.0	10	9	22.0	16.0	2.5	2.620
* SO 53021-6-4-4	058.3004.046	200	10x1.0	12	9	24.0	16.0	3.5	4.130
* SO 53021-6-4-6	058.3004.049	200	10x1.0	12	9	24.0	16.0	3.5	4.060
* SO 53021-6-6-4	058.3004.053	200	10x1.0	12	9	24.0	16.0	3.5	4.060
* SO 53021-6-8-6	058.3004.058	200	12x1.0	14	10	26.5	18.0	4.5	5.660
* SO 53021-8-6-6	058.3004.091	200	12x1.0	14	10	26.5	18.0	4.5	5.660
* SO 53021-8-6-8	058.3004.093	200	12x1.0	14	10	26.5	18.0	4.5	5.340
* SO 53021-8-8-6	058.3004.100	200	12x1.0	14	10	26.5	18.0	4.5	5.340
* SO 53021-8-10-8	058.3004.104	160	14x1.0	17	12	32.0	20.5	6.5	8.830
* SO 53021-10-8-8	058.3004.151	160	14x1.0	17	12	32.0	20.5	6.5	8.830
* SO 53021-10-8-10	058.3004.153	160	14x1.0	17	12	32.0	20.5	6.5	8.640
* SO 53021-10-10-8	058.3004.161	160	14x1.0	17	12	32.0	20.5	6.5	8.640
* SO 53021-10-12-10	058.3004.165	160	16x1.0	19	14	33.5	21.5	8.5	11.300
* SO 53021-12-10-10	058.3004.220	160	16x1.0	19	14	33.5	21.5	8.5	11.300
* SO 53021-12-10-12	058.3004.222	160	16x1.0	19	14	33.5	21.5	8.5	11.000
* SO 53021-12-12-10	058.3004.232	160	16x1.0	19	14	33.5	21.5	8.5	11.000
* SO 53021-12-15-12	058.3004.254	100	20x1.5	24	17	38.5	24.5	10.0	19.770
* SO 53021-15-12-12	058.3004.417	100	20x1.5	24	17	38.5	24.5	10.0	19.770
* SO 53021-15-12-15	058.3004.422	100	20x1.5	24	17	38.5	24.5	10.0	19.210
* SO 53021-15-15-12	058.3004.435	100	20x1.5	24	17	38.5	24.5	10.0	19.210
* SO 53021-15-18-15	058.3004.447	100	24x1.5	30	22	42.0	26.5	13.0	32.010
* SO 53021-18-15-15	058.3004.624	100	24x1.5	30	22	42.0	26.5	13.0	32.010
* SO 53021-18-15-18	058.3004.628	100	24x1.5	30	22	42.0	26.5	13.0	31.290
* SO 53021-18-18-15	058.3004.644	100	24x1.5	30	22	42.0	26.5	13.0	31.260
* SO 53021-18-22-18	058.3004.654	64	28x1.5	32	27	49.5	30.5	16.0	43.480
* SO 53021-22-18-18	058.3004.854	64	28x1.5	32	27	49.5	30.5	16.0	43.480
* SO 53021-22-18-22	058.3004.862	64	28x1.5	32	27	49.5	30.5	16.0	40.680
* SO 53021-22-22-18	058.3004.888	64	28x1.5	32	27	49.5	30.5	16.0	40.680
SO 53021-28-22-28	058.3004.948	40	36x2.0	41	36	62.5	43.0	19.0	88.000

Weitere reduzierte T-Verschraubungen, z. B. 16 mm, können mit dem Reduzierklemmring SO 50001 RED oder der Reduktionsverschraubung SO 51821 zusammengestellt werden.

D'autres téés réduits, p. ex. 16 mm, peuvent s'obtenir par bague de serrage de réduction SO 50001 RED ou par raccord de réduction SO 51821.

Further tee reductions, e. g. 16 mm, can be produced with the reduction ferrule SO 50001 RED, or the reduction union SO 51821.

d=Rohrassen- \varnothing
e=kleinste Bohrung
L=Mass in montiertem Zustand
*=mit reduziertem Klemmring

d= \varnothing extérieur du tube
e= \varnothing -min. de passage
L=après montage
*=avec bague de serrage de réduction

d=tube outside diameter
e=minimum bore
L=installed length
*=with reduction compression ferrule

T-Verschraubung

mit Übergangsnippel SO 50040

Té égal

avec adaptateur mâle SO 50040

Tee union

with male adaptor SO 50040

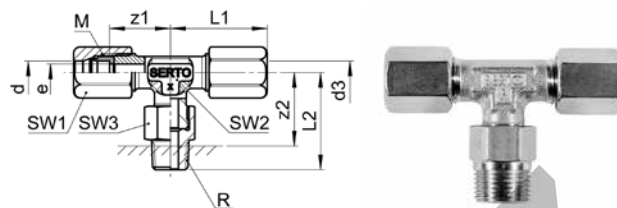

SO 53121

Type - d - R - d3	Mat.-Nr.	bar	M	SW1	SW2	SW3	L1	L2	z1	z2	e	kg/100
Für metrische Rohre	Pour tubes métriques			For metric tubes								
R=Rohrgewinde (kegelig)	R=Filetage-gaz BSP (conique)			R=BSP thread (tapered)								
SO 53121-4-1/8-4	058.3101.040	250	8x1.0	10	9	10	21.5	26.0	16.0	19.5	3.5	2.770
* SO 53121-4-1/4-4	058.3101.045	200	10x1.0	12	9	14	24.0	30.0	16.0	20.5	3.5	5.090
SO 53121-5-1/8-5	058.3101.070	250	8x1.0	10	9	10	22.0	26.0	16.0	19.5	3.5	2.730
* SO 53121-5-1/4-5	058.3101.075	200	10x1.0	12	9	14	24.0	30.0	16.0	20.5	4.0	5.010
SO 53121-6-1/8-6	058.3101.100	200	10x1.0	12	9	12	24.0	26.0	16.0	19.5	4.5	3.940
SO 53121-6-1/4-6	058.3101.110	200	10x1.0	12	9	14	24.0	30.0	16.0	20.5	4.5	4.910
SO 53121-6-1/2-6	058.3101.125	200	10x1.0	12	9	22	24.0	32.0	16.0	22.0	4.5	8.000
SO 53121-8-1/8-8	058.3101.160	200	12x1.0	14	10	14	26.5	28.0	18.0	21.5	6.0	5.270
SO 53121-8-1/4-8	058.3101.170	200	12x1.0	14	10	14	26.5	32.0	18.0	22.5	6.5	5.740
* SO 53121-8-3/8-8	058.3101.180	160	14x1.0	17	12	17	32.0	34.5	20.5	24.5	6.5	9.330
* SO 53121-8-1/2-8	058.3101.190	160	14x1.0	17	12	22	32.0	35.5	20.5	22.5	6.5	11.660
SO 53121-10-1/8-10	058.3101.260	160	14x1.0	17	12	17	32.0	31.0	20.5	26.0	6.0	7.770
SO 53121-10-1/4-10	058.3101.270	160	14x1.0	17	12	17	32.0	34.5	20.5	25.0	8.5	8.240
SO 53121-10-3/8-10	058.3101.280	160	14x1.0	17	12	17	32.0	34.5	20.5	24.5	8.5	8.950
SO 53121-10-1/2-10	058.3101.290	160	14x1.0	17	12	22	32.0	35.5	20.5	22.5	8.5	11.280
SO 53121-12-1/4-12	058.3101.380	160	16x1.0	19	14	19	33.5	36.5	21.5	27.0	8.5	10.460
SO 53121-12-3/8-12	058.3101.390	160	16x1.0	19	14	19	33.5	35.5	21.5	25.5	9.5	10.710
SO 53121-12-1/2-12	058.3101.400	160	16x1.0	19	14	22	33.5	39.5	21.5	26.5	9.5	13.320
* SO 53121-14-1/2-14	058.3101.540	100	20x1.5	24	17	24	38.5	42.0	24.5	29.0	12.0	18.850
SO 53121-15-1/2-15	058.3101.590	100	20x1.5	24	17	24	38.5	42.5	24.5	29.0	13.0	18.610
* SO 53121-16-1/2-16	058.3101.630	100	24x1.5	30	22	30	42.0	46.0	26.5	33.0	13.5	30.140
SO 53121-18-1/2-18	058.3101.730	100	24x1.5	30	22	30	42.0	46.5	26.5	33.0	13.5	29.590
SO 53121-18-3/4-18	058.3101.740	100	24x1.5	30	22	30	42.0	50.5	30.5	35.5	15.0	42.140
SO 53121-22-3/4-22	058.3101.830	64	28x1.5	32	27	36	49.5	51.0	30.5	35.5	19.0	39.340

Für Zollrohre

Pour tubes pouces

For inch tubes

SO 53121-6,35-1/8-6,35	058.3101.140	200	10x1.0	12	9	12	24.0	26.0	16.0	19.5	4.5	3.900
SO 53121-6,35-1/4-6,35	058.3101.145	200	10x1.0	12	9	14	24.0	30.0	16.0	20.5	4.5	4.870
SO 53121-9,52-3/8-9,52	058.3101.215	160	14x1.0	17	12	17	32.0	34.5	20.5	24.5	8.0	9.010
* SO 53121-21,3-3/4-21,3	058.3101.800	64	28x1.5	32	27	36	50.0	50.5	30.5	35.5	19.0	40.740

Umrechnung für "d" bei Zollrohren:

6,35 = 1/4
 9,52 = 3/8
 21,3 = 27/32

Conversion de "d" pour tubes en pouces:

6,35 = 1/4
 9,52 = 3/8
 21,3 = 27/32

Conversion for "d" for inch tubes:

6,35 = 1/4
 9,52 = 3/8
 21,3 = 27/32

Montagehinweis: Nippel ist handfest montiert. Bei Endmontage mit 1/4 Umdrehung anziehen.
 Wir empfehlen eine zusätzliche Schmierung auf der Planfläche.

Note d'installation: L'adaptateur femelle-mâle est monté serré à la main. Pour le montage final, serrer avec 1/4 de tour.
 Nous recommandons une lubrification supplémentaire sur la surface plane.

Assembly information: Male adaptor is mounted finger-tight. For final assembly, tighten with 1/4 turn.
 We recommend additional lubrication on the plane surface.

d=Rohrassen-ø
 e=kleinste Bohrung
 L=Mass in montiertem Zustand
 *=mit reduziertem Klemmring

d=ø extérieur du tube
 e=ø-min. de passage
 L=après montage
 *=avec bague de serrage de réduction

d=tube outside diameter
 e=minimum bore
 L=installed length
 *=with reduction compression ferrule

T-Verschraubung

mit Übergangsnippel SO 50040 NPT

Té égal

avec adaptateur mâle SO 50040 NPT

Tee union

with male adaptor SO 50040 NPT

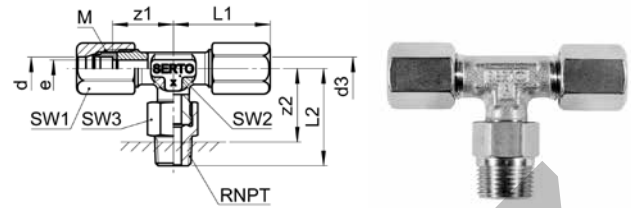

SO 53121 NPT

Type -d -RNPT -d3	Mat.-Nr.	bar	M	SW1	SW2	SW3	L1	L2	z1	z2	e	kg/100
Für metrische Rohre	Pour tubes métriques			For metric tubes								
RNPT=NPT Gewinde	RNPT=Filetage NPT			RNPT=NPT thread								
SO 53121-6-1/8 NPT-6	058.3102.100	200	10x1.0	12	9	12	24.0	28.0	16.0	21.5	4.5	4.050
SO 53121-6-1/4 NPT-6	058.3102.110	200	10x1.0	12	9	14	24.0	32.0	16.0	22.0	4.5	5.080
SO 53121-8-1/4 NPT-8	058.3102.170	200	12x1.0	14	10	14	26.5	34.0	18.0	24.0	6.5	5.900
SO 53121-10-1/4 NPT-10	058.3102.270	160	14x1.0	17	12	17	32.0	36.5	20.5	26.5	8.5	8.350
* SO 53121-10-1/2 NPT-10	058.3102.290	160	16x1.0	19	14	22	33.5	42.5	20.5	29.0	8.5	14.220
SO 53121-12-1/4 NPT-12	058.3102.380	160	16x1.0	19	14	19	33.5	38.5	21.5	27.0	8.5	10.540
SO 53121-12-3/8 NPT-12	058.3102.390	160	16x1.0	19	14	19	33.5	38.5	21.5	27.0	9.5	10.750
SO 53121-12-1/2 NPT-12	058.3102.400	160	16x1.0	19	14	22	33.5	42.5	21.5	29.0	9.5	13.820
* SO 53121-14-1/2 NPT-14	058.3102.540	100	20x1.5	24	17	24	38.5	45.0	24.5	31.5	12.0	19.530
SO 53121-15-1/2 NPT-15	058.3102.590	100	20x1.5	24	17	24	38.5	45.0	24.5	31.5	13.0	18.950

Für Zollrohre

Pour tubes pouces

For inch tubes

SO 53121-6,35-1/8 NPT-6,35	058.3102.140	200	10x1.0	12	9	12	24.0	28.0	16.0	21.5	4.5	4.010
SO 53121-6,35-1/4 NPT-6,35	058.3102.145	200	10x1.0	12	9	14	24.0	32.0	16.0	22.0	4.5	5.040
SO 53121-9,52-1/4 NPT-9,52	058.3102.210	160	14x1.0	17	12	17	32.0	36.5	16.0	27.0	8.0	8.410

Umrechnung für "d" bei Zollrohren:

6,35 = 1/4
9,52 = 3/8

Conversion de "d" pour tubes en pouces:

6,35 = 1/4
9,52 = 3/8

Conversion for "d" for inch tubes:

6,35 = 1/4
9,52 = 3/8

Montagehinweis: Nippel ist handfest montiert. Bei Endmontage mit 1/4 Umdrehung anziehen.
Wir empfehlen eine zusätzliche Schmierung auf der Planfläche.

Note d'installation: L'adaptateur femelle-mâle est monté serré à la main. Pour le montage final, serrer avec 1/4 de tour.
Nous recommandons une lubrification supplémentaire sur la surface plane.

Assembly information: Male adaptor is mounted finger-tight. For final assembly, tighten with 1/4 turn.
We recommend additional lubrication on the plane surface.

d=Rohrassen-ø
e=kleinste Bohrung
L=Mass in montiertem Zustand
*=mit reduziertem Klemmring

d=ø extérieur du tube
e=ø-min. de passage
L=après montage
*=avec bague de serrage de réduction

d=tube outside diameter
e=minimum bore
L=installed length
*=with reduction compression ferrule

T-Verschraubung

mit Übergangsnippel SO 50040 METR

Té égal

avec adaptateur mâle SO 50040 METR

Tee union

with male adaptor SO 50040 METR

SO 53121 METR

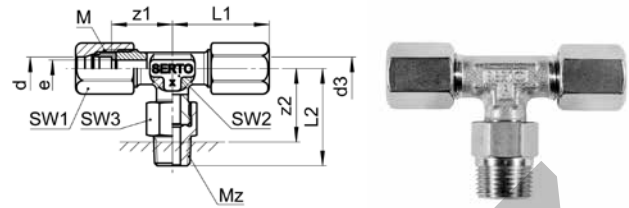

Type -d -Mz -d3	Mat.-Nr.	bar	M	SW1	SW2	SW3	L1	L2	z1	z2	e	kg/100
Mz=metrisches Gewinde (zylindrisch)	Mz=Filetage métrique (cylindrique)	Mz=Metric thread (parallel)										
* SO 53121-3-M6x0,75-3	058.3143.055	250	8x1.0	10	9	10	22.0	24.5	16.0	19.0	2.5	2.610
* SO 53121-3-M8x1-3	058.3143.060	250	8x1.0	10	9	10	22.0	26.0	16.0	20.0	2.5	2.720
SO 53121-4-M6x0,75-4	058.3143.085	250	8x1.0	10	9	10	22.0	24.0	16.0	19.0	2.5	2.510
SO 53121-4-M8x1-4	058.3143.090	250	8x1.0	10	9	10	22.0	26.0	16.0	20.0	3.5	2.620
SO 53121-5-M6x0,75-5	058.3143.115	250	8x1.0	10	9	10	22.0	24.0	16.0	19.0	2.5	2.470
SO 53121-5-M8x1-5	058.3143.125	250	8x1.0	10	9	10	22.0	26.0	16.0	20.0	3.5	2.580

Montagehinweis: Nippel ist handfest montiert. Bei Endmontage mit 1/4 Umdrehung anziehen.

Wir empfehlen eine zusätzliche Schmierung auf der Planfläche.

Note d'installation: L'adaptateur femelle-mâle est monté serré à la main. Pour le montage final, serrer avec 1/4 de tour.

Nous recommandons une lubrification supplémentaire sur la surface plane.

Assembly information: Male adaptor is mounted finger-tight. For final assembly, tighten with 1/4 turn.

We recommend additional lubrication on the plane surface.

T-Verschraubung

mit Übergangsmuffe SO 50030

Té égal

avec adaptateur femelle SO 50030

Tee union

with female adaptor SO 50030

SO 53221

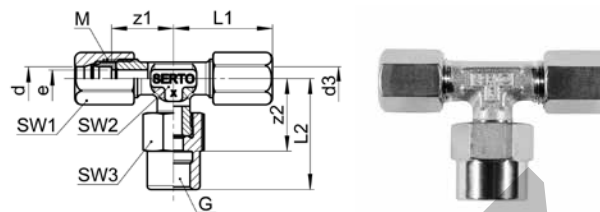

Type -d-G-d3	Mat.-Nr.	bar	M	SW1	SW2	SW3	L1	L2	z1	z2	e	kg/100
Für metrische Rohre	Pour tubes métriques						For metric tubes					
G=Rohrgewinde (zylindrisch)	G=Filetage-gaz BSP (cylindrique)						G=BSP thread (parallel)					
★ SO 53221-4-1/8-4	058.3201.040	200	10x1.0	12	9	14	24.0	29.0	16.0	19.0	3.5	4.820
★ SO 53221-5-1/8-5	058.3201.070	200	10x1.0	12	9	14	24.0	29.0	16.0	19.0	4.0	4.780
SO 53221-6-1/8-6	058.3201.100	200	10x1.0	12	9	14	24.0	29.0	16.0	19.0	4.5	4.680
SO 53221-6-1/4-6	058.3201.110	200	10x1.0	12	9	17	24.0	30.0	16.0	19.0	4.5	6.760
SO 53221-6-1/2-6	058.3201.125	200	10x1.0	12	9	27	24.0	33.0	16.0	19.0	4.5	10.800
SO 53221-8-1/8-8	058.3201.160	200	12x1.0	14	10	17	26.5	31.0	18.0	21.0	6.5	6.850
SO 53221-8-1/4-8	058.3201.170	200	12x1.0	14	10	17	26.5	33.0	18.0	22.0	6.5	6.440
SO 53221-8-3/8-8	058.3201.180	200	12x1.0	14	10	22	26.5	33.0	18.0	21.0	6.5	8.990
SO 53221-8-1/2-8	058.3201.190	200	12x1.0	14	10	27	26.5	35.0	18.0	21.0	6.5	11.990
SO 53221-10-1/4-10	058.3201.270	160	14x1.0	17	12	17	32.0	34.5	20.5	23.5	8.5	8.540
SO 53221-10-3/8-10	058.3201.280	160	14x1.0	17	12	22	32.0	35.5	20.5	23.5	8.5	10.720
SO 53221-10-1/2-10	058.3201.285	160	14x1.0	17	12	27	32.0	37.5	20.5	23.5	8.5	14.070
SO 53221-12-1/4-12	058.3201.380	160	16x1.0	19	14	19	33.5	35.5	21.5	24.5	8.5	11.290
SO 53221-12-3/8-12	058.3201.390	160	16x1.0	19	14	22	33.5	36.5	21.5	24.5	9.5	12.210
SO 53221-12-1/2-12	058.3201.400	100	16x1.0	19	14	27	33.5	37.5	21.5	23.5	9.5	17.200
★ SO 53221-14-1/2-14	058.3201.540	100	20x1.5	24	17	27	38.5	42.0	24.5	28.0	12.0	21.520
SO 53221-15-1/4-15	058.3201.528	100	20x1.5	24	17	24	38.5	35.5	24.5	25.5	11.5	18.140
SO 53221-15-1/2-15	058.3201.590	100	20x1.5	24	17	27	38.5	42.0	24.5	28.0	13.0	21.040
★ SO 53221-16-1/2-16	058.3201.630	100	24x1.5	30	22	30	42.0	45.0	26.5	31.0	14.0	33.480
SO 53221-18-1/2-18	058.3201.730	100	24x1.5	30	22	30	42.0	45.0	26.5	31.0	15.0	32.380
Für Zollrohre	Pour tubes pouces						For inch tubes					
SO 53221-6,35-1/8-6,35	058.3201.140	200	10x1.0	12	9	14	24.0	29.0	16.0	19.0	4.5	4.640
SO 53221-9,52-1/4-9,52	058.3201.210	160	14x1.0	17	12	17	32.0	34.5	20.5	23.5	8.0	8.600
★ SO 53221-13,5-1/2-13,5	058.3201.514	100	20x1.5	24	17	27	38.5	42.0	24.5	28.0	12.0	21.820

Umrechnung für "d" bei Zollrohren:

 6,35 = 1/4
 9,52 = 3/8
 13,5 = 17/32

Conversion de "d" pour tubes en pouces:

 6,35 = 1/4
 9,52 = 3/8
 13,5 = 17/32

Conversion for "d" for inch tubes:

 6,35 = 1/4
 9,52 = 3/8
 13,5 = 17/32

Montagehinweis: Muffe ist handfest montiert. Bei Endmontage mit 1/4 Umdrehung anziehen.

Wir empfehlen eine zusätzliche Schmierung auf der Planfläche.

Note d'installation: L'adaptateur femelle est monté serré à la main. Pour le montage final, serrer avec 1/4 de tour.

Nous recommandons une lubrification supplémentaire sur la surface plane.

Assembly information: Female adaptor is mounted finger-tight. For final assembly, tighten with 1/4 turn.

We recommend additional lubrication on the plane surface.

d=Rohrassen-ø
 e=kleinste Bohrung
 L=Mass in montiertem Zustand
 *=mit reduziertem Klemming

d=ø extérieur du tube
 e=ø-min. de passage
 L=après montage
 *=avec bague de serrage de réduction

d=tube outside diameter
 e=minimum bore
 L=installed length
 *=with reduction compression ferrule

Einstellbare T-Verschraubung

Té orientable au centre

Adjustable tee union

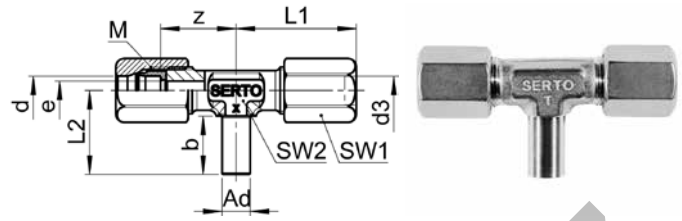

SO 53621 T

Type -d -Ad -d3	Mat.-Nr.	bar	M	SW1	SW2	L1	L2	b	z	e	kg/100	
Für metrische Rohre	Pour tubes métriques			For metric tubes								
* SO 53621-4-A6-4	058.3600.045	200	10x1.0	12	9	24.0	18.0	12.5	16.0	3.5	3.170	
* SO 53621-5-A6-5	058.3600.053	200	10x1.0	12	9	24.0	18.0	12.5	16.0	4.0	3.130	
SO 53621-6-A6-6	058.3600.060	200	10x1.0	12	9	24.0	18.0	12.5	16.0	4.0	3.030	
* SO 53621-6-A8-6	058.3600.063	200	12x1.0	14	10	26.5	23.0	15.0	18.0	4.5	4.420	
SO 53621-8-A8-8	058.3600.080	200	12x1.0	14	10	26.5	23.0	15.0	18.0	6.0	4.020	
* SO 53621-8-A10-8	058.3600.083	160	14x1.0	17	12	32.0	25.5	17.0	20.5	6.5	6.760	
SO 53621-10-A10-10	058.3600.100	160	14x1.0	17	12	32.0	25.5	17.0	20.5	7.0	6.420	
SO 53621-12-A12-12	058.3600.120	160	16x1.0	19	17	33.5	26.5	18.0	21.5	9.0	10.060	
Für Zollrohre	Pour tubes pouces			For inch tubes								
SO 53621-6,35-A6-6,35	058.3600.067	200	10x1.0	12	9	24.0	18.0	12.5	16.0	4.0	2.990	
* SO 53621-6,35-A8-6,35	058.3600.070	200	12x1.0	14	10	26.5	23.0	15.0	18.0	4.5	4.380	

Umrechnung für "d" bei Zollrohren:
6,35 = 1/4

Conversion de "d" pour tubes en pouces:
6,35 = 1/4

Conversion for "d" for inch tubes:
6,35 = 1/4

Anwendungsbeispiele:

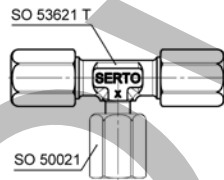

Mögliche Kombinationen:

- mit Armaturenanschluss zu einstellbaren T-Verschraubungen
- mit Verschraubungen zu einstellbaren Verschraubungen
- mit Einschraubverschraubungen zu einstellbaren T-Einschraubverschraubungen. Gegenüber der T-Einschraubverschraubung lässt sich diese Kombination einfacher einstellen, da Einschrauben und Ausrichten getrennt voneinander vorgenommen werden.

Exemples d'utilisation:

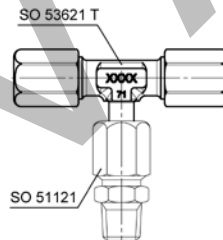

Combinaisons possibles:

- avec écrou de raccordement ça donne un Té orientable
- avec raccords ça donne des raccords orientables
- avec une union mâle ça donne un Té fileté orientable. Par rapport au Té orientable, cette combinaison est facile à régler, puisque le vissage et l'alignement sont réalisés séparément l'un de l'autre.

Sample combinations:

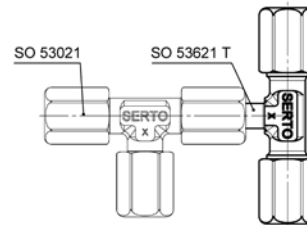

Possible combinations:

- with nut connections to adjustable tee unions
- with unions to adjustable unions
- with male adaptor unions to adjustable male adaptor tee unions. This combination is simpler to produce, as screwing in and alignment are carried out separately.

d=Rohrassens-ø
Ad=Aussen-ø der Andrehung
e=kleinste Bohrung
L=Mass in montiertem Zustand
*=mit reduziertem Klemmring

d=ø extérieur du tube
Ad=ø extérieur de la portée cylindrique
e=ø-min. de passage
L=après montage
*=avec bague de serrage de réduction

d=tube outside diameter
Ad=outside diameter of cyl. stub
e=minimum bore
L=installed length
*=with reduction compression ferrule

Einstellbare L-Verschraubung

Té orientable en bout

Adjustable L union

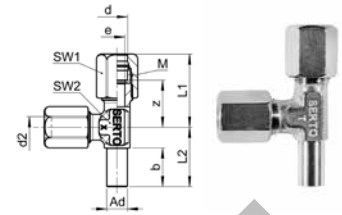

SO 53621 L

Type -d -d2 -Ad	Mat.-Nr.	bar	M	SW1	SW2	L1	L2	b	z	e	kg/100	
Für metrische Rohre	Pour tubes métriques			For metric tubes								
* SO 53621-4-4-A6	058.3610.045	200	10x1.0	12	9	24.0	18.0	12.5	16.0	3.5	3.170	
* SO 53621-5-5-A6	058.3610.053	200	10x1.0	12	9	24.0	18.0	12.5	16.0	4.0	3.130	
SO 53621-6-6-A6	058.3610.060	200	10x1.0	12	9	24.0	18.0	12.5	16.0	4.0	3.030	
* SO 53621-6-6-A8	058.3610.063	200	12x1.0	14	10	26.5	23.0	15.0	18.0	4.5	4.420	
SO 53621-8-8-A8	058.3610.080	200	12x1.0	14	10	26.5	23.0	15.0	18.0	6.0	4.020	
* SO 53621-8-8-A10	058.3610.083	160	14x1.0	17	12	32.0	25.5	17.0	20.5	6.5	6.760	
SO 53621-10-10-A10	058.3610.100	160	14x1.0	17	12	32.0	25.5	17.0	20.5	7.0	6.760	
SO 53621-12-12-A12	058.3610.120	160	16x1.0	19	17	33.5	26.5	18.0	21.5	9.0	10.060	
Für Zollrohre	Pour tubes pouces			For inch tubes								
SO 53621-6,35-6,35-A6	058.3610.061	200	10x1.0	12	9	24.0	18.0	12.5	16.0	4.0	2.990	
* SO 53621-6,35-6,35-A8	058.3610.068	200	12x1.0	14	10	26.5	23.0	15.0	18.0	4.5	4.380	

Umrechnung für "d" bei Zollrohren:
6,35 = 1/4

Conversion de "d" pour tubes en pouces:
6,35 = 1/4

Conversion for "d" for inch tubes:
6,35 = 1/4

Anwendungsbeispiele:

Exemples d'utilisation:

Sample combinations:



Mögliche Kombinationen:

- mit Armaturenanschluss zu einstellbaren L-Verschraubungen
- mit Verschraubungen zu einstellbaren Verschraubungen
- mit Einschraubverschraubungen zu einstellbaren L-Einschraubverschraubungen. Gegenüber der L-Einschraubverschraubung lässt sich diese Kombination einfacher einstellen, da Einschrauben und Ausrichten getrennt voneinander vorgenommen werden.

Combinaisons possibles:

- avec écrou de raccordement ça donne un L orientable
- avec raccords ça donne des raccords orientables
- avec une union mâle ça donne un L fileté orientable. Par rapport au L orientable, cette combinaison est facile à régler, puisque le vissage et l'alignement sont réalisés séparément l'un de l'autre.

Possible combinations:

- with nut connections to adjustable L unions
- with unions to adjustable unions
- with male adaptor unions to adjustable male adaptor L unions. This combination is simpler to produce, as screwing in and alignment are carried out separately.

d=Rohrassens-ø
Ad=Aussen-ø der Andrehung
e=kleinste Bohrung
L=Mass in montiertem Zustand
*=mit reduziertem Klemmring

d=ø extérieur du tube
Ad=ø extérieur de la portée cylindrique
e=ø-min. de passage
L=après montage
*=avec bague de serrage de réduction

d=tube outside diameter
Ad=outside diameter of cyl. stub
e=minimum bore
L=installed length
*=with reduction compression ferrule

Einstellbare T-Verschraubung vor-
montiert
Té orientable au centre prémonté
Adjustable tee union pre-assembled

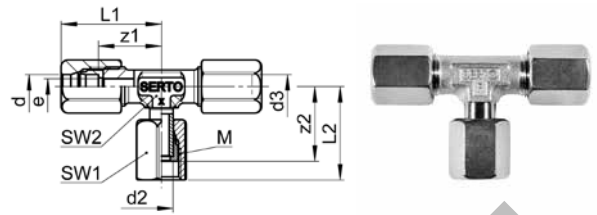
SO 53625 T

Type -d -d2 -d3	Mat.-Nr.	bar	M	SW1	SW2	L1	L2	z1	z2	e	kg/100
Für metrische Rohre	Pour tubes métriques			For metric tubes							
* SO 53625-4-A6-4	058.3620.045	200	10x1.0	12	9	24.0	25.5	16.0	19.0	3.5	3.710
* SO 53625-5-A6-5	058.3620.053	200	10x1.0	12	9	24.0	25.5	16.0	19.0	4.0	3.650
SO 53625-6-A6-6	058.3620.060	200	10x1.0	12	9	24.0	25.5	16.0	19.0	4.0	3.820
* SO 53625-6-A8-6	058.3620.063	200	12x1.0	14	10	26.5	31.5	18.0	24.0	4.5	5.470
SO 53625-8-A8-8	058.3620.080	200	12x1.0	14	10	26.5	31.5	18.0	24.0	6.0	5.070
* SO 53625-8-A10-8	058.3620.083	160	14x1.0	17	12	32.0	33.5	20.5	26.5	6.5	8.550
SO 53625-10-A10-10	058.3620.100	160	14x1.0	17	12	32.0	33.5	20.5	26.5	7.0	8.200
SO 53625-12-A12-12	058.3620.120	160	16x1.0	19	17	33.5	34.5	21.5	27.5	9.0	12.700
Für Zollrohre	Pour tubes pouces			For inch tubes							
SO 53625-6,35-A6-6,35	058.3620.067	200	10x1.0	12	9	24.0	25.5	16.0	19.0	4.0	3.780
* SO 53625-6,35-A8-6,35	058.3620.070	200	12x1.0	14	10	26.5	31.5	18.0	24.0	4.5	4.430

Umrechnung für "d" bei Zollrohren:
6,35 = 1/4

Conversion de "d" pour tubes en pouces:
6,35 = 1/4

Conversion for "d" for inch tubes:
6,35 = 1/4

Montagehinweis: Anschlussmutter auf Seite Einstellteil mit 1/4 Umdrehung anziehen. Wir empfehlen eine zusätzliche Schmierung auf der Planfläche.

Note d'installation: Serrez l'écrou du côté orientable de 1/4 de tour. Nous recommandons une lubrification supplémentaire sur la surface plane.

Assembly information: Tighten the union nut on the adjustable side with 1/4 turn. We recommend additional lubrication on the plane surface.

d=Rohraussen-ø
e=kleinste Bohrung
L=Mass in montiertem Zustand
*=mit reduziertem Klemmring

d=ø extérieur du tube
e=ø-min. de passage
L=après montage
*=avec bague de serrage de réduction

d=tube outside diameter
e=minimum bore
L=installed length
*=with reduction compression ferrule

Einstellbare L-Verschraubung vormontiert

Té orientable en bout prémonté

Adjustable L union pre-assembled

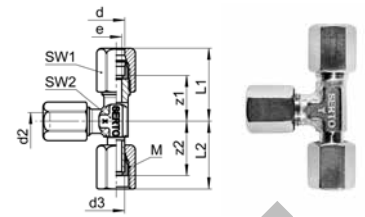

SO 53625 L

Type -d -d2 -d3	Mat.-Nr.	bar	M	SW1	SW2	L1	L2	z1	z2	e	kg/100
Für metrische Rohre	Pour tubes métriques			For metric tubes							
* SO 53625-4-4-A6	058.3630.045	200	10x1.0	12	9	24.0	25.5	16.0	19.0	3.5	3.710
* SO 53625-5-5-A6	058.3630.053	200	10x1.0	12	9	24.0	25.5	16.0	19.0	4.0	3.650
SO 53625-6-6-A6	058.3630.060	200	10x1.0	12	9	24.0	25.5	16.0	19.0	4.0	3.820
* SO 53625-6-6-A8	058.3630.063	200	12x1.0	14	10	26.5	31.5	18.0	24.0	4.5	5.470
SO 53625-8-8-A8	058.3630.080	200	12x1.0	14	10	26.5	31.5	18.0	24.0	6.0	5.070
* SO 53625-8-8-A10	058.3630.083	160	14x1.0	17	12	32.0	33.5	20.5	26.5	6.5	8.550
SO 53625-10-10-A10	058.3630.100	160	14x1.0	17	12	32.0	33.5	20.5	26.5	7.0	8.200
SO 53625-12-12-A12	058.3630.120	160	16x1.0	19	17	33.5	34.5	21.5	27.5	9.0	12.700
Für Zollrohre	Pour tubes pouces			For inch tubes							
SO 53625-6,35-6,35-A6	058.3630.061	200	10x1.0	12	9	24.0	25.5	16.0	19.0	4.0	3.780
* SO 53625-6,35-6,35-A8	058.3630.068	200	12x1.0	14	10	26.5	31.5	18.0	24.0	4.5	4.430

Umrechnung für "d" bei Zollrohren:
6,35 = 1/4

Conversion de "d" pour tubes en pouces:
6,35 = 1/4

Conversion for "d" for inch tubes:
6,35 = 1/4

Montagehinweis: Anschlussmutter auf Seite Einstellteil mit 1/4 Umdrehung anziehen. Wir empfehlen eine zusätzliche Schmierung auf der Planfläche.

Note d'installation: Serrez l'écrou du côté orientable de 1/4 de tour. Nous recommandons une lubrification supplémentaire sur la surface plane.

Assembly information: Tighten the union nut on the adjustable side with 1/4 turn. We recommend additional lubrication on the plane surface.

Kreuzverschraubung

Croix égale

Cross union

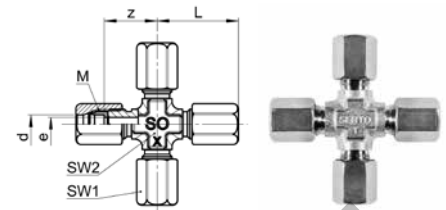

SO 54021

Type-d	Mat.-Nr.	bar	M	SW1	SW2	L	z	e	kg/100
Für metrische Rohre	Pour tubes métriques			For metric tubes					
* SO 54021-4	058.4000.040	200	10x1.0	12	12	25.5	17.5	3.5	5.600
* SO 54021-5	058.4000.050	200	10x1.0	12	12	25.5	17.5	4.0	5.550
SO 54021-6	058.4000.060	200	10x1.0	12	12	25.5	17.5	4.5	5.500
SO 54021-8	058.4000.080	200	12x1.0	14	12	27.5	19.0	6.5	7.400
SO 54021-10	058.4000.100	160	14x1.0	17	14	34.5	23.0	8.5	11.400
SO 54021-12	058.4000.120	160	16x1.0	19	14	37.5	25.0	9.5	13.900
* SO 54021-14	058.4000.140	100	20x1.5	24	17	40.5	26.5	12.0	25.300
SO 54021-15	058.4000.150	100	20x1.5	24	17	40.5	26.5	13.0	24.500
Für Zollrohre	Pour tubes pouces			For inch tubes					
SO 54021-6,35	058.4000.063	200	10x1.0	12	12	25.5	17.5	4.5	5.500
SO 54021-9,52	058.4000.095	160	14x1.0	17	14	34.5	23.0	8.0	11.600
SO 54021-12,7	058.4000.127	160	20x1.5	24	17	40.0	26.5	11.0	28.000
* SO 54021-13,5	058.4000.135	100	20x1.5	24	17	40.5	26.5	12.0	25.800

Umrechnung für "d" bei Zollrohren:

6,35 = 1/4
 9,52 = 3/8
 12,7 = 1/2
 13,5 = 17/32

Conversion de "d" pour tubes en pouces:

6,35 = 1/4
 9,52 = 3/8
 12,7 = 1/2
 13,5 = 17/32

Conversion for "d" for inch tubes:

6,35 = 1/4
 9,52 = 3/8
 12,7 = 1/2
 13,5 = 17/32

Ventile Edelstahl
Vannes acier inoxydable
Valves stainless steel
SO NV 51A00

Regulierventil mit Innengewinde
 Vanne de réglage avec taraudage
 Regulating valve with female thread

522
SO NV 51A21

Regulierventil
 Vanne de réglage
 Regulating valve

522
SO NV 51A30

Regulierventil mit Übergangsmuffe
 SO 50030
 Vanne de réglage avec adaptateur femelle
 SO 50030
 Regulating valve with female adaptor
 SO 50030

523
SO NV 51A40

Regulierventil mit Übergangsnippel
 SO 50040
 Vanne de réglage avec adaptateur mâle
 SO 50040
 Regulating valve with male adaptor
 SO 50040

524
SO NV 51C00

Feinregulierventil mit Innengewinde
 Vanne de réglage fin avec taraudage
 Fine regulating valve with female thread

525
SO NV 51C21

Feinregulierventil
 Vanne de réglage fin
 Fine regulating valve

525
SO NV 51D21

Dosierventil
 Vanne de réglage de précision
 Metering valve

526
SO NV 51A21E

Regulier-Eckventil
 Vanne-équerre de réglage
 Elbow regulating valve

527
SO NV 51A30E

Regulier-Eckventil mit Übergangsmuffe
 SO 50030
 Vanne-équerre de réglage avec adaptateur
 femelle SO 50030
 Elbow regulating valve with female adaptor
 SO 50030

528
SO NV 51A40E

Regulier-Eckventil mit Übergangsnippel
 SO 50040
 Vanne-équerre de réglage avec adaptateur
 mâle SO 50040
 Elbow regulating valve with male adaptor
 SO 50040

529
SO NV 51A21EB

Regulier-Eckventil mit Einschraubgewinde
 Vanne-équerre de réglage avec filetage
 Elbow regulating valve with male thread

530
SO NV 51A60EL

Regulier-Eckventil mit Einstellzapfen
 Vanne-équerre de réglage orientable
 Elbow regulating valve adjustable

530

Ventile Edelstahl
Vannes acier inoxydable
Valves stainless steel

SO NV 51C21E

Feinregulier-Eckventil
Vanne-équerre de réglage fin
Elbow fine regulating valve

531

SO NV 51C21EB

Feinregulier-Eckventil mit Einschraubgewinde
Vanne-équerre de réglage fin avec filetage
Elbow fine regulating valve with male thread

532

SO NV 51C60EL

Feinregulier-Eckventil mit Einstellzapfen
Vanne-équerre de réglage fin orientable
Elbow fine regulating valve adjustable

532

SO CV 53B00

Kegelrückschlagventil mit Innengewinde
Clapet anti-retour à siège conique avec taraudage
Taper seat non-return valve with female thread

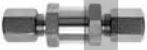
535

SO CV 53B21

Kegelrückschlagventil
Clapet anti-retour à siège conique
Taper seat non-return valve

535

SO CV 53B30

Kegelrückschlagventil mit Übergangsmuffe SO 50030
Clapet anti-retour à siège conique avec adaptateur femelle SO 50030
Taper seat non-return valve with female adaptor SO 50030

536

SO CV 53B40

Kegelrückschlagventil mit Übergangsnippel SO 50040
Clapet anti-retour à siège conique avec adaptateur mâle SO 50040
Taper seat non-return valve with male adaptor SO 50040

537

SO BV 58A00

Kugelhahn mit Innengewinde
Vanne à bille avec taraudage
Ball valve with female thread

538

SO BV 58D00

Sechskant Kugelhahn mit Innengewinde
Vanne à bille hexagonale avec taraudage
Hexagon ball valve with female thread

539

SO BV 58D21

Kugelhahn
Vanne à bille
Ball valve

540

SO BV 58D30

Kugelhahn mit Übergangsmuffe SO 50030
Vanne à bille avec adaptateur femelle SO 50030
Ball valve with female adaptor SO 50030

541

SO BV 58D40

Kugelhahn mit Übergangsnippel SO 50040
Vanne à bille avec adaptateur mâle SO 50040
Ball valve with male adaptor SO 50040

542

SO NV 51B00

Nadelventil mit Innengewinde
Vanne à pointeau avec taraudage
Needle valve with female thread

543**SO NV 51B21**

Nadelventil
Vanne à pointeau
Needle valve

544**VSD SO NV**

Ventilschilder (Satz)
Plaques signalétiques (set)
Valve labels (set)

553

AD HN 50 R

Doppelnippel R-R
Mamelon double R-R
Male threaded adaptor R-R

684
AD HN 50 R-NPT

Doppelnippel R-NPT
Mamelon double R-NPT
Male threaded adaptor R-NPT

684
AD HN 50 NPT-NPT

Doppelnippel NPT-NPT
Mamelon double NPT-NPT
Male threaded adaptor NPT-NPT

685
ADH HNC 50

Doppelnippel G-G 60°-Innenkonus
Mamelon double G-G cône intérieur 60°
Male threaded adaptor G-G 60° inner cone

685
ADH HNIC 50



Doppelnippel G-R 60° Innenkonus / kegeli-
ges Aussengewinde
Mamelon double G-R cône intérieur 60° /
filetage conique
Male threaded adaptor G-R 60° inner
cone / tapered male thread

685
ADH A 50

Sechskantnippel G-G 60° Innenkonus /
Innengewinde
Adaptateur hexagonal G-G cône intérieur
60° / taraudage
Hexagonal nipple G-G 60° inner cone /
female thread

686
AD CN 50

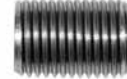
Rohrdoppelnippel R
Mamelon double tubulaire R
Tube double threaded nipple R

686
AD CNS 50

Rohrnippel G
Mamelon tubulaire G
Tube nipple G

687
AD CNW 50

Rohranschweissnippel R
Embout fileté à souder R
Weld-on nipple R

687
AD CNW 50 NPT

Rohranschweissnippel NPT
Embout fileté à souder NPT
Weld-on nipple NPT

687
AD A 50 G-R

Übergangsnippel G-R
Adaptateur femelle G - mâle R
Adaptor female G - male R

688
AD A 50 G-NPT

Übergangsnippel G-NPT
Adaptateur femelle G - mâle NPT
Adaptor female G - male NPT

689

Adapter Edelstahl

Adaptateurs acier inoxydable Adaptors stainless steel

AD A 50 NPT-R



Übergangsnippel NPT-R
Adaptateur femelle NPT - mâle R
Adaptor female NPT - male R

689

AD A 50 NPT-NPT



Übergangsnippel NPT-NPT
Adaptateur femelle NPT - mâle NPT
Male adaptor NPT-NPT

690

AD C 50



Muffe lang G
Manchon long G
Threaded socket long G

690

AD CS 50



Muffe kurz G
Manchon court G
Threaded socket short G

691

AD FCW 50



Hochdruckanschweissmuffe NPT
Manchon à souder pour haute pression NPT
High-pressure weld-on socket NPT

691

AD HC 50

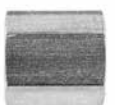

Sechskantmuffe G
Manchon hexagonal G
Hexagonal threaded socket G

691

AD HRC 50



Sechskantmuffe G reduziert
Manchon hexagonal G réduit
Hexagonal threaded socket G reduced

692

AD HCP 50



Rohrkappe
Capuchon
Hexagonal cap

692

AD HP 50 R



Verschlussschraube R mit Aussen-6kt.
Bouchon fileté R à six pans
Screw plug R with hex-nut

692

AD HP 50 NPT



Verschlussschraube NPT mit Aussen-6kt.
Bouchon fileté NPT à six pans
Screw plug NPT with hex-nut

693

AD SP 50



Verschlussschraube R mit Innen-6kt.
Bouchon fileté R avec six pans creux
Screw plug R locked with Allen key

693

AD HPS 50



Verschlussschraube G mit Aussen-6kt.
Bouchon fileté G à six pans
Screw plug G with hex-nut

694

AD HPO 50

Verschlusschraube G mit Aussen-6kt. und Conovor O-Ringabdichtung (FKM)
 Bouchon fileté G à six pans, avec joint torique système Conovor (FKM)
 Screw plug G with hex-nut with and Conovor O-ring seal (FKM)

694

AD HSP 50

Verschlusschraube G mit Innen-6kt.
 Bouchon fileté G avec six pans creux
 Screw plug G locked with Allen key

695

AD HSPO 50

Verschlusschraube G mit Innen-6kt. und Conovor O-Ringabdichtung (FKM)
 Bouchon fileté G avec six pans creux et joint torique système Conovor (FKM)
 Screw plug G locked with Allen key and Conovor O-ring seal (FKM)

695

AD HCN 50

Sechskant-Kontermutter
 Contre-écrou à six pans
 Hexagonal counter nut

696

AD FE 51

Aufschraub-Winkel G
 Coude femelle G
 Female threaded elbow G

696

AD SE 51

Einschraub-/Aufschraub-Winkel G-R
 Coude mâle - femelle G-R
 Male/female threaded elbow G-R

697

AD FT 51

Aufschraub-T G
 Té femelle G
 Female threaded tee G

697

SO 50511

Einschraubtülle R
 Douille cannelée à visser R
 Male adaptor hose nozzle R

698

SO 50511 NPT

Einschraubtülle NPT
 Douille cannelée à visser NPT
 Male adaptor hose nozzle NPT

699

SERTO Online Shop

- tagesaktuelle Daten und Preise
- Bestellung per Klick rund um die Uhr
- Zugriff auf Bestellhistorie

SERTO Online Shop

- données et prix actualisés quotidiennement
- commander jour et nuit
- accès à l'historique des commandes

SERTO Online Shop

- daily updated data and prices
- just click to order, any time of the day
- access to order history

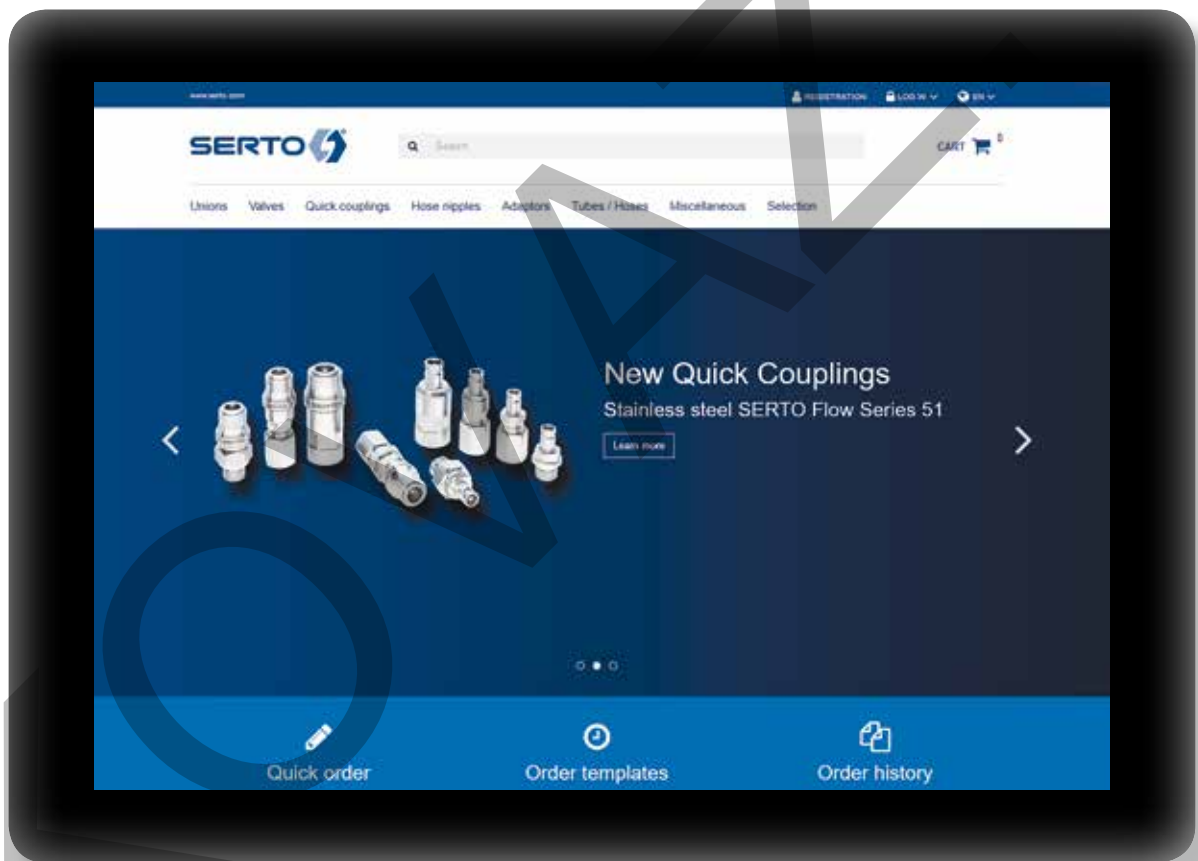

shop.serto.com

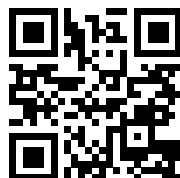

Edelstahl L

Hochdruck-Verschraubungen

Acier inoxydable L

Raccords à haute pression

Stainless steel L

High pressure unions



Seite/Page/Page

Seite/Page/Page

Seite/Page/Page

Abschlusszapfen
Bouchon d'arrêt
Plug



SO 50002

Gerade Schottverschraubung
Union double traversée de cloison
Panel mount union



SOL 51521

T-Verschraubung
Té égal
Tee union



SOL 53021

Armaturenanschluss
Ecrou et bague de raccordement
Nut connection



SOL 50021

Einstellbare Einschraubverschraubung
Union mâle orientable
Adjustable male adaptor union



SOL 51625

Einstellbare T- und L-Verschraubung
Té et L orientable
Adjustable tee and L union



SOL 53621 T

Gerade Verschraubung
Union double
Straight union



SOL 51021

Reduktions-Einstellverschraubung
Raccord de réduction orientable
Adjustable reduction union



SOL 51821

Kreuzverschraubung
Croix égale
Cross union



SOL 54021

Gerade Einschraubverschraubung
Union mâle
Male adaptor union



SOL 51121

Winkelverschraubung
Coude
Elbow union



SOL 52021

Sonderausführungen auf Anfrage
Exécution en option sur demande
Optional services on request



Spezialreinigung - entfettet
Traitement spécial - dégraissé
Special treatment - degreased



Spezialbehandlung für Einsatz mit Sauerstoff
Traitement spécial pour utilisation sous oxygène
Special treatment for use with oxygen



Spezialbehandlung - silikonfrei
Traitement spécial - sans silicone
Special treatment - silicone free



Vorbeschichtete Gewinde mit Loctite 5061
Filetages pré enduits avec Loctite 5061
Pre-coated threads with Loctite 5061

Gerade Aufschraubverschraubung
Union femelle
Female adaptor union



SOL 51221

Winkel-Einschraubverschraubung
Coude mâle
Male adaptor elbow union



SOL 52421

Verbindungsrippel
Pièce folle
Tube stub



SOL 51300

Einstellbare Winkelverschraubung
Coude orientable
Adjustable elbow union



SOL 52621

Einstellbare Verschraubung
Union orientable
Adjustable union



SOL 51325

Winkel-Schottverschraubung
Coude traversée de cloison
Panel mount elbow union



SOL 52721

Anschweisverschraubung
Union avec embout à souder
Weld-on union



SOL 51429

Schwenverschraubung
Coude banjo
Single banjo



SOL 52824



Eigenschaften, Besonderheiten

- hohe Druckbeständigkeit
- einfache, robuste Montage dank Anzugsbegrenzung
- korrosionsbeständig
- kompakte Bauform
- sehr gute Vibrationsresistenz

Werkstoff

Edelstahl 1.4571 (≈ AISI 316 Ti),
Legierung X6CrNiMoTi17-12-2,
DIN EN 10088-3

Betriebsdruck PN (stat.)

200 – 400 bar, Details siehe Produkttabellen
(4-fache Sicherheit)

Temperaturbereich

-196 °C bis +500 °C, bis +600 °C auf Anfrage

Helium-Leckrate

10⁸ mbar • l/s *

Vakuum

10⁶ mbar

Anzuschliessende Rohre

Nahtlose Präzisionsrohre aus Edelstahl
(DIN EN 10216-5/EN ISO 1127) mit
sauberer, glatter Oberfläche. Toleranz
Aussendurchmesser ± 0.1 mm. Siehe auch
Kapitel i und Kapitel 19. Weitere Materialien
auf Anfrage.

Abnahmeprüfzeugnis

Abnahmeprüfzeugnis 3.1 nach EN 10204
(kostenpflichtig)

Zulassungen/Zertifizierungen

DVGW, SVGW

Bestätigungen

FDA für FKM-O-Ringe

Einschraubzapfen, Gewinde

Rohrgewinde (Zoll) und metrisches Fein-
gewinde DIN 3852, kegelig nach Form C, mit
Dichtkante nach Form B. NPT-Gewinde nach
ANSI B1.20.1.

Zum Abdichten der kegeligen Einschraub-
gewinde empfehlen wir Loctite® 5061.

Druckauswertungsgrad in % des PN



* bei fachgerechter Montage können Werte von
10⁹ mbar • l/s erreicht werden; siehe Kapitel i:
- Montageanleitung
- Rohrempfehlungen

Propriétés, spécificités

- haute résistance de pression
- montage facile et solide grâce à la limitation de serrage
- résistant à la corrosion
- construction compacte
- très bonne résistance à la vibration

Matériau

Acier inoxydable 1.4571 (≈ AISI 316 Ti),
avec l'alliage X6CrNiMoTi17-12-2,
DIN EN 10088-3

Pression de service PN (stat.)

200 – 400 bar, détails voir tableaux des pro-
duits (facteur de sécurité 4)

Plage de température admissible

-196 °C à +500 °C, jusqu'à +600 °C sur demande

Débit de fuite avec hélium

10⁸ mbar • l/s *

Vide

10⁶ mbar

Tubes à utiliser

Tubes en acier inoxydable sans soudure (selon
DIN EN 10216-5/EN ISO 1127), avec
surface propre et lisse. Tolérance du diamètre
extérieur de ± 0.1 mm. Voir aussi chapitre i et
chapitre 19. Autres matériaux sur demande.

Certificat de réception

Certificat de réception selon EN 10204
(payant)

Certifications

DVGW, SVGW

Confirmations

FDA pour les joints toriques FKM

Embouts mâles, filetages

Filetage-gaz (BSP) et filetage métrique à pas
fin DIN 3852; conique selon forme C; filetage
d'étanchéité selon forme B. Filetage NPT selon
ANSI B1.20.1.

Pour assurer l'étanchéité des filetages mâles
coniques, nous recommandons Loctite® 5061.

Coefficient de pression de service admissible en % de PN

Characteristics, specifications

- high pressure resistance
- easy, robust assembly due to tightening limitation
- corrosion resistant
- compact design
- very good resistance to vibration

Material

Stainless steel 1.4571 (≈ AISI 316 Ti)
with alloy X6CrNiMoTi17-12-2,
DIN EN 10088-3

Working pressure PN (stat.)

200 – 400 bar; for details, see product tables
(safety factor 4)

Temperature range

-196 °C to +500 °C, up to +600 °C on request

Leak rate with helium

10⁸ mbar • l/s *

Vacuum

10⁶ mbar

Tubes to use

Stainless steel seamless precision tubes (to
DIN EN 10216-5/EN ISO 1127) with clean
smooth surface. Tolerance of outside diameter
± 0.1 mm. See also chapter i and chapter 19.
Further materials on request.

Inspection certificate

Inspection certificate 3.1 according to
EN 10204 (with costs)

Approvals

DVGW, SVGW

Confirmations

FDA for FKM O-rings

Adaptor stem, male thread

British Standard Pipe (BSP) and metric fine
thread DIN 3852; tapered form C; thread
with edge seal form B. NPT-thread according to
ANSI/B1.20.1.

For sealing of the tapered male adaptor thread
we recommend Loctite® 5061.

Pressure coefficient % of PN

Abschlusszapfen

Bouchon d'arrêt

Plug

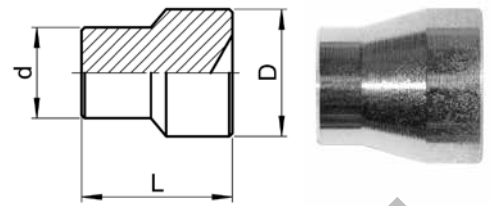

SO 50002

Type -d	Mat.-Nr.	L	D	kg/100
Für metrische Rohre	Pour tubes métriques		For metric tubes	
SO 50002-6	056.0020.060	9.5	8.3	0.310
SO 50002-8	056.0020.080	10.0	10.3	0.530
SO 50002-10	056.0020.100	13.0	12.3	0.960
SO 50002-12	056.0020.120	14.0	13.6	1.400
SO 50002-15	056.0020.150	16.5	16.6	2.460
SOL 50002-16	076.0020.160	19.0	18.5	3.380
SO 50002-18	056.0020.180	19.0	20.5	4.290
Für Zollrohre	Pour tubes pouces		For inch tubes	
SO 50002-6,35	056.0020.063	9.5	8.3	0.310
SO 50002-9,52	056.0020.095	13.0	12.3	0.950
SO 50002-12,7	056.0020.127	15.5	16.6	1.900

Umrechnung für "d" bei Zollrohren:

6,35 = 1/4

9,52 = 3/8

12,7 = 1/2

Conversion de "d" pour tubes en pouces:

6,35 = 1/4

9,52 = 3/8

12,7 = 1/2

Conversion for "d" for inch tubes:

6,35 = 1/4

9,52 = 3/8

12,7 = 1/2

Anwendungsbeispiele:

Der Abschlusszapfen lässt sich in jede Verschraubung anstelle eines Klemmringes der gleichen Grösse einsetzen. Wird ein reduzierter Klemmring durch einen Abschlusszapfen ersetzt, so muss immer von der Grösse der Anschlussmutter ausgegangen werden.

Montagehinweis: Anschlussmutter mit 1/4 Umdrehung anziehen.

Exemples d'utilisation:

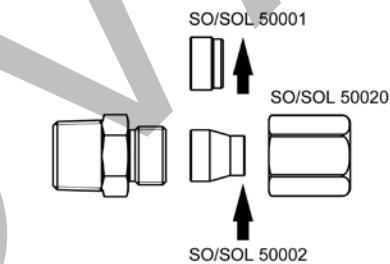

Le bouchon d'arrêt s'insère dans tout raccord au lieu d'une bague de serrage de la même taille. Si une bague de serrage de réduction est remplacée par un bouchon d'arrêt, la taille de l'écrou de raccordement doit toujours être prise en compte.

Note d'installation: Serrez l'écrou d'accouplement de 1/4 de tour.

Sample combinations:

The plug can be inserted into all unions instead of a compression ferrule of the same size. If a reduction compression ferrule is replaced by a plug, the size of the union nut must be used as a basis.

Assembly information: Tighten the union nut with 1/4 turn.

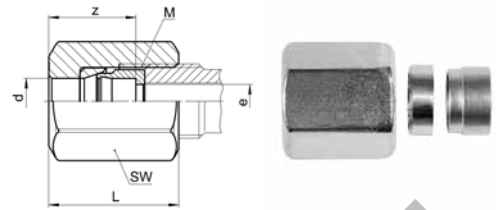
Armaturenanschluss
Ecrou et bague de raccordement
Nut connection

SOL 50021

Type -d	Mat.-Nr.	bar	M	SW	L	z	e	kg/100
Für metrische Rohre	Pour tubes métriques			For metric tubes				
SOL 50021-6	076.0210.060	400	10x1.0	14	17.5	10.0	4.5	1.650
SOL 50021-8	076.0210.080	330	12x1.0	17	18.5	10.5	6.5	2.500
SOL 50021-10	076.0210.100	330	14x1.0	19	20.5	12.5	8.5	3.270
SOL 50021-12	076.0210.120	330	16x1.0	22	21.5	13.5	10.0	4.600
SOL 50021-15	076.0210.150	250	20x1.5	27	25.0	15.0	13.0	7.860
SOL 50021-16	076.0210.160	200	24x1.5	30	26.5	18.5	14.0	10.400
SOL 50021-18	076.0210.180	200	24x1.5	30	26.5	17.5	16.0	9.500
Für Zollrohre	Pour tubes pouces			For inch tubes				
SOL 50021-6,35	076.0210.063	400	10x1.0	14	17.5	10.5	4.5	1.700
SOL 50021-9,52	076.0210.095	330	14x1.0	19	20.5	12.5	8.0	3.600
SOL 50021-12,7	076.0210.127	330	20x1.5	27	25.0	15.0	11.0	8.700

Umrechnung für "d" bei Zollrohren:

6,35 = 1/4

9,52 = 3/8

12,7 = 1/2

Conversion de "d" pour tubes en pouces:

6,35 = 1/4

9,52 = 3/8

12,7 = 1/2

Conversion for "d" for inch tubes:

6,35 = 1/4

9,52 = 3/8

12,7 = 1/2

Gerade Verschraubung

Union double

Straight union

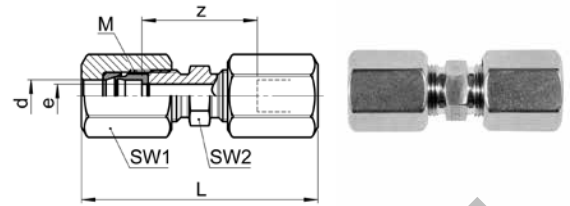

SOL 51021

Type -d	Mat.-Nr.	bar	M	SW1	SW2	L	z	e	kg/100
Für metrische Rohre	Pour tubes métriques		For metric tubes						
SOL 51021-6	078.1020.060	400	10x1.0	14	10	42.0	22.5	4.5	4.180
SOL 51021-8	078.1020.080	330	12x1.0	17	12	46.0	25.0	6.5	6.250
SOL 51021-10	078.1020.100	330	14x1.0	19	14	51.0	26.0	8.5	8.190
SOL 51021-12	078.1020.120	330	16x1.0	22	17	53.0	26.5	10.0	11.340
SOL 51021-15	078.1020.150	250	20x1.5	27	22	62.0	31.5	13.0	19.520
SOL 51021-16	078.1020.160	200	24x1.5	30	24	70.0	33.0	14.0	26.460
SOL 51021-18	078.1020.180	200	24x1.5	30	24	67.0	33.0	15.0	24.660
Für Zollrohre	Pour tubes pouces		For inch tubes						
SOL 51021-6,35	078.1020.063	400	10x1.0	14	10	43.0	22.5	4.5	4.300
SOL 51021-9,52	078.1020.095	330	14x1.0	19	14	51.0	26.0	8.0	8.900
SOL 51021-12,7	078.1020.127	330	20x1.5	27	22	62.0	32.0	11.0	21.700

Umrechnung für "d" bei Zollrohren:

 6,35 = 1/4
 9,52 = 3/8
 12,7 = 1/2

Conversion de "d" pour tubes en pouces:

 6,35 = 1/4
 9,52 = 3/8
 12,7 = 1/2

Conversion for "d" for inch tubes:

 6,35 = 1/4
 9,52 = 3/8
 12,7 = 1/2

Gerade Einschraubverschraubung

Union mâle

Male adaptor union

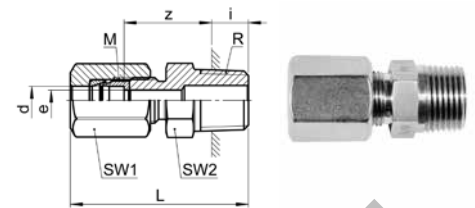

SOL 51121

Type -d -R	Mat.-Nr.	bar	M	SW1	SW2	L	i	z	e	kg/100
Für metrische Rohre R=Rohrgewinde (kegelig)	Pour tubes métriques R=Filetage-gaz BSP (conique)	For metric tubes R=BSP thread (tapered)								
SOL 51121-6-1/8	078.1101.100	400	10x1.0	14	10	31.0	5.0	17.0	4.5	2.550
SOL 51121-6-1/4	078.1101.110	400	10x1.0	14	14	37.0	8.0	21.0	4.5	3.650
SOL 51121-6-3/8	078.1101.120	400	10x1.0	14	17	37.0	8.0	20.6	4.5	4.040
SOL 51121-6-1/2	078.1101.125	400	10x1.0	14	22	42.0	10.0	23.8	4.5	6.160
SOL 51121-8-1/8	078.1101.160	330	12x1.0	17	12	32.5	5.0	18.0	6.0	3.540
SOL 51121-8-1/4	078.1101.170	330	12x1.0	17	14	38.5	8.0	22.0	6.5	4.430
SOL 51121-8-3/8	078.1101.180	330	12x1.0	17	17	38.5	8.0	21.6	6.5	4.520
SOL 51121-8-1/2	078.1101.185	330	12x1.0	17	22	43.5	10.0	24.8	6.5	7.050
SOL 51121-10-1/4	078.1101.270	330	14x1.0	19	14	40.5	8.0	22.0	8.5	5.020
SOL 51121-10-3/8	078.1101.280	330	14x1.0	19	17	40.5	8.0	21.6	8.5	6.130
SOL 51121-10-1/2	078.1101.285	330	14x1.0	19	22	45.5	10.0	24.8	8.5	9.290
SOL 51121-12-1/4	078.1101.380	330	16x1.0	22	17	41.5	8.0	22.0	8.5	6.980
SOL 51121-12-3/8	078.1101.390	330	16x1.0	22	17	41.5	8.0	21.6	10.0	7.180
SOL 51121-12-1/2	078.1101.400	330	16x1.0	22	22	46.5	10.0	24.8	10.0	10.050
SOL 51121-15-3/8	078.1101.532	250	20x1.5	27	22	45.5	8.0	24.1	10.5	12.490
SOL 51121-15-1/2	078.1101.534	250	20x1.5	27	22	50.5	10.0	27.3	13.0	12.680
SOL 51121-16-1/2	078.1101.566	200	24x1.5	30	24	55.0	10.0	28.3	13.5	16.500
SOL 51121-16-3/4	078.1101.568	200	24x1.5	30	27	55.0	12.0	27.0	14.0	17.680
SOL 51121-18-1/2	078.1101.646	200	24x1.5	30	24	53.0	10.0	28.3	13.5	15.100
SOL 51121-18-3/4	078.1101.648	200	24x1.5	30	27	54.0	12.0	27.0	15.0	16.280

Für Zollrohre	Pour tubes pouces	For inch tubes								
SOL 51121-6,35-1/8	078.1101.135	400	10x1.0	14	10	31.0	5.0	25.0	4.5	2.600
SOL 51121-6,35-1/4	078.1101.140	400	10x1.0	14	14	37.0	8.0	19.0	4.5	3.700
SOL 51121-6,35-3/8	078.1101.145	400	10x1.0	14	17	37.0	8.0	21.0	4.5	4.100
SOL 51121-6,35-1/2	078.1101.150	400	10x1.0	14	22	42.0	10.0	22.0	4.5	6.700
SOL 51121-9,52-1/4	078.1101.230	330	14x1.0	19	14	40.0	8.0	22.0	8.0	5.500
SOL 51121-9,52-3/8	078.1101.235	330	14x1.0	19	17	40.0	8.0	22.0	8.0	6.600
SOL 51121-9,52-1/2	078.1101.240	330	14x1.0	19	22	45.0	10.0	23.0	8.0	8.700
SOL 51121-12,7-1/2	078.1101.434	330	20x1.5	27	22	48.5	10.0	27.5	11.0	9.600

Umrechnung für "d" bei Zollrohren:

 6,35 = 1/4
 9,52 = 3/8
 12,7 = 1/2

Conversion de "d" pour tubes en pouces:

 6,35 = 1/4
 9,52 = 3/8
 12,7 = 1/2

Conversion for "d" for inch tubes:

 6,35 = 1/4
 9,52 = 3/8
 12,7 = 1/2

Gerade Einschraubverschraubung NPT

Union mâle NPT

Male adaptor union NPT

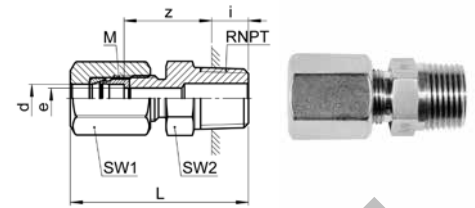

SOL 51121 NPT

Type -d -RNPT	Mat.-Nr.	bar	M	SW1	SW2	L	i	z	e	kg/100
Für metrische Rohre	Pour tubes métriques		For metric tubes							
RNPT=NPT Gewinde	RNPT=Filetage NPT		RNPT=NPT thread							
SOL 51121-6-1/8 NPT	078.1102.100	400	10x1.0	14	12	34.0	7.0	19.9	4.5	2.820
SOL 51121-6-1/4 NPT	078.1102.110	400	10x1.0	14	14	39.0	10.0	23.2	4.5	3.830
SOL 51121-8-1/8 NPT	078.1102.160	330	12x1.0	17	12	35.5	7.0	20.9	6.0	4.120
SOL 51121-8-1/4 NPT	078.1102.170	330	12x1.0	17	14	40.5	10.0	24.2	6.5	4.600
SOL 51121-8-3/8 NPT	078.1102.180	330	12x1.0	17	17	40.5	10.0	23.9	6.5	5.450
SOL 51121-8-1/2 NPT	078.1102.185	330	12x1.0	17	22	46.5	14.0	27.9	6.5	7.090
SOL 51121-10-1/4 NPT	078.1102.270	330	14x1.0	19	14	42.5	10.0	24.2	8.5	5.130
SOL 51121-10-1/2 NPT	078.1102.285	330	14x1.0	19	22	48.5	14.0	27.9	8.5	9.760
SOL 51121-12-1/4 NPT	078.1102.380	330	16x1.0	22	17	43.5	10.0	24.2	8.5	7.040
SOL 51121-12-3/8 NPT	078.1102.390	330	16x1.0	22	17	43.5	10.0	23.9	10.0	7.330
SOL 51121-12-1/2 NPT	078.1102.400	330	16x1.0	22	22	49.5	14.0	27.9	10.0	10.520
SOL 51121-12-3/4 NPT	078.1102.405	330	16x1.0	22	27	52.5	14.0	30.4	10.0	11.390
SOL 51121-15-1/2 NPT	078.1102.534	250	20x1.5	27	22	53.0	14.0	30.4	13.0	13.040
SOL 51121-16-1/2 NPT	078.1102.566	200	24x1.5	30	24	57.5	14.0	31.4	13.5	20.850
SOL 51121-18-1/2 NPT	078.1102.646	200	24x1.5	30	24	56.0	14.0	31.4	13.5	19.950

Für Zollrohre	Pour tubes pouces		For inch tubes							
SOL 51121-6,35-1/8 NPT	078.1102.135	400	10x1.0	14	12	33.0	7.0	20.0	4.5	3.000
SOL 51121-6,35-1/4 NPT	078.1102.140	400	10x1.0	14	14	38.0	10.0	23.5	4.5	4.000
SOL 51121-9,52-1/4 NPT	078.1102.230	330	14x1.0	19	14	47.0	10.0	24.5	8.0	5.700
SOL 51121-9,52-1/2 NPT	078.1102.240	330	14x1.0	19	22	48.0	14.0	28.0	8.0	10.600
SOL 51121-12,7-1/2 NPT	078.1102.434	330	20x1.5	27	22	50.0	14.0	30.5	11.0	14.900

Umrechnung für "d" bei Zollrohren:

6,35 = 1/4
 9,52 = 3/8
 12,7 = 1/2

Conversion de "d" pour tubes en pouces:

6,35 = 1/4
 9,52 = 3/8
 12,7 = 1/2

Conversion for "d" for inch tubes:

6,35 = 1/4
 9,52 = 3/8
 12,7 = 1/2

Gerade Einschraubverschraubung

mit Dichtkante

Union mâle

avec arête d'étanchéité

Male adaptor union

with edge seal

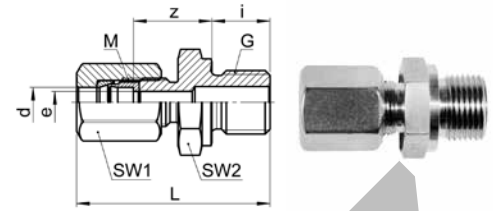

SOL 51124

Type - d - G	Mat.-Nr.	bar	M	SW1	SW2	L	D	i	t	z	e	kg/100
Für metrische Rohre	Pour tubes métriques					For metric tubes						
G=Rohrgewinde (zylindrisch)	G=Filetage-gaz BSP (cylindrique)					G=BSP thread (parallel)						
SOL 51124-6-1/8	078.1141.100	400	10x1.0	14	14	32.5	14.5	8.0	1.0	14.5	4.5	2.900
SOL 51124-6-1/4	078.1141.110	400	10x1.0	14	19	38.0	18.5	12.0	1.5	16.0	4.5	4.400
SOL 51124-6-3/8	078.1141.120	400	10x1.0	14	22	39.5	22.5	12.0	2.0	17.5	4.5	4.400
SOL 51124-6-1/2	078.1141.125	400	10x1.0	14	27	42.0	27.0	14.0	2.5	18.0	4.5	7.600
SOL 51124-8-1/8	078.1141.160	330	12x1.0	17	14	34.0	14.5	8.0	1.0	15.5	5.0	5.200
SOL 51124-8-1/4	078.1141.170	330	12x1.0	17	19	39.5	18.5	12.0	1.5	17.0	6.5	4.400
SOL 51124-8-1/2	078.1141.185	330	12x1.0	17	27	43.5	27.0	14.0	2.5	19.0	6.5	8.200
SOL 51124-10-1/4	078.1141.270	330	14x1.0	19	19	41.5	18.5	12.0	1.5	17.0	7.0	6.000
SOL 51124-10-3/8	078.1141.280	330	14x1.0	19	22	43.0	22.5	12.0	2.0	18.5	8.5	7.500
SOL 51124-10-1/2	078.1141.285	330	14x1.0	19	27	45.5	27.0	14.0	2.5	19.0	8.5	10.300
SOL 51124-10-3/4	078.1141.290	330	14x1.0	19	32	48.5	33.0	16.0	2.5	20.0	8.5	12.600
SOL 51124-12-1/4	078.1141.380	330	16x1.0	22	19	42.5	18.5	12.0	1.5	17.0	7.0	7.600
SOL 51124-12-3/8	078.1141.390	330	16x1.0	22	22	44.0	22.5	12.0	2.0	18.5	10.0	8.400
SOL 51124-12-1/2	078.1141.400	330	16x1.0	22	27	46.5	27.0	14.0	2.5	19.0	10.0	9.900
SOL 51124-12-3/4	078.1141.405	330	16x1.0	22	32	49.5	33.0	16.0	2.5	20.0	10.0	12.100
SOL 51124-15-1/2	078.1141.534	250	20x1.5	27	27	50.5	27.0	14.0	2.5	21.0	13.0	14.000
SOL 51124-16-1/2	078.1141.566	200	24x1.5	30	27	53.5	27.0	14.0	2.5	21.0	13.5	18.200
SOL 51124-16-1	078.1141.570	200	24x1.5	30	41	59.5	40.0	18.0	2.5	23.0	13.5	22.500
SOL 51124-18-1/2	078.1141.646	200	24x1.5	30	27	52.0	27.0	14.0	2.5	21.5	13.5	16.700

Für Zollrohre	Pour tubes pouces					For inch tubes						
SOL 51124-6,35-1/8	078.1141.135	400	10x1.0	14	14	31.5	14.5	8.0	1.0	14.5	4.5	3.000
SOL 51124-6,35-1/4	078.1141.140	400	10x1.0	14	19	38.5	18.5	12.0	1.5	16.0	4.5	3.000
SOL 51124-6,35-3/8	078.1141.145	400	10x1.0	14	22	40.0	22.5	12.0	2.0	17.5	4.5	5.500
SOL 51124-6,35-1/2	078.1141.150	400	10x1.0	14	27	42.5	27.0	14.0	2.5	18.0	4.5	7.700
SOL 51124-9,52-1/4	078.1141.230	330	14x1.0	19	19	41.5	18.5	12.0	1.5	17.0	7.0	6.500
SOL 51124-9,52-3/8	078.1141.235	330	14x1.0	19	22	43.0	22.5	12.0	2.0	18.5	8.0	7.900
SOL 51124-9,52-1/2	078.1141.240	330	14x1.0	19	27	45.5	27.0	14.0	2.5	19.0	8.0	10.800
SOL 51124-12,7-1/2	078.1141.434	330	20x1.5	27	27	50.5	27.0	14.0	2.5	21.5	11.0	15.300
SOL 51124-12,7-3/4	078.1141.536	330	20x1.5	27	32	52.0	33.0	16.0	2.5	22.5	11.0	15.100

Umrechnung für "d" bei Zollrohren:

6,35 = 1/4

9,52 = 3/8

12,7 = 1/2

Conversion de "d" pour tubes en pouces:

6,35 = 1/4

9,52 = 3/8

12,7 = 1/2

Conversion for "d" for inch tubes:

6,35 = 1/4

9,52 = 3/8

12,7 = 1/2

Einbauempfehlung:

Conseil de montage:

Recommendation for installation:

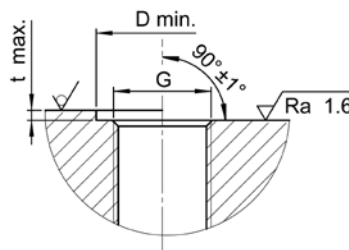

d=Rohrøussen-ø
e=kleinste Bohrung
L=Mass in montiertem Zustand

d=ø extérieur du tube
e=ø-min. de passage
L=après montage

d=tube outside diameter
e=minimum bore
L=installed length

Gerade Einschraubverschraubung METR

Union mâle METR

Male adaptor union METR

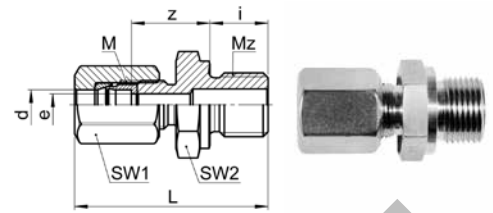

SOL 51124 METR

Type -d -Mz	Mat.-Nr.	bar	M	SW1	SW2	L	i	z	e	kg/100
Für metrische Rohre	Pour tubes métriques									
Mz=metrisches Gewinde (zylindrisch)	Mz=Filetage métrique (cylindrique)									
SOL 51124-6-M5	078.1143.155	400	10x1.0	14	10	27.5	4.5	13.0	2.2	1.800
Für Zollrohre	Pour tubes pouces									
SOL 51124-6,35-M5	078.1143.205	400	10x1.0	14	10	26.5	4.5	13.0	2.2	1.800

Umrechnung für "d" bei Zollrohren:
6,35 = 1/4

Conversion de "d" pour tubes en pouces:
6,35 = 1/4

Conversion for "d" for inch tubes:
6,35 = 1/4

Gerade Einschraubverschraubung

mit Conovor O-Ringabdichtung (FKM)

Union mâle

avec joint torique système Conovor (FKM)

Male adaptor union

with Conovor O-ring seal (FKM)

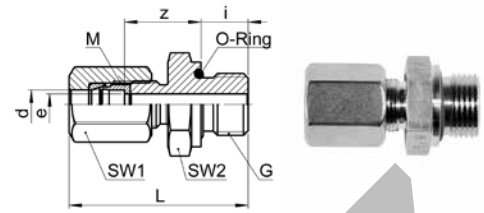

SOL 51124 OR

Type -d-G	Mat.-Nr.	bar	M	SW1	SW2	L	D	i	t	O-Ring	z	e	kg/100
Für metrische Rohre	Pour tubes métriques					For metric tubes							
G=Rohrgewinde (zylindrisch)	G=Filetage-gaz BSP (cylindrique)					G=BSP thread (parallel)							
SOL 51124-6-1/8 OR	078.1171.100	400	10x1.0	14	14	32.5	14.5	8.0	1.0	8.73x1.78	14.5	4.5	2.960
SOL 51124-6-1/4 OR	078.1171.110	400	10x1.0	14	19	36.0	18.5	10.0	1.5	11.1x1.78	16.0	4.5	4.260
SOL 51124-8-1/4 OR	078.1171.170	330	12x1.0	17	19	37.5	18.5	10.0	1.5	11.1x1.78	17.0	6.5	5.150
SOL 51124-10-1/4 OR	078.1171.270	330	14x1.0	19	19	39.5	18.5	10.0	1.5	11.1x1.78	17.0	7.0	5.890
SOL 51124-10-3/8 OR	078.1171.280	330	14x1.0	19	22	41.0	22.5	10.0	1.5	14.0x1.78	18.5	8.5	7.390
SOL 51124-12-3/8 OR	078.1171.390	330	16x1.0	22	22	42.0	22.5	10.0	1.5	14.0x1.78	18.5	10.0	8.390
SOL 51124-12-1/2 OR	078.1171.400	330	16x1.0	22	27	44.5	27.0	12.0	2.5	18.72x2.62	19.0	10.0	9.790
SOL 51124-15-1/2 OR	078.1171.534	250	20x1.5	27	27	48.5	27.0	12.0	2.5	18.72x2.62	21.5	13.0	13.850
SOL 51124-16-1/2 OR	078.1171.566	200	24x1.5	30	27	52.0	27.0	12.0	2.5	18.72x2.62	21.5	13.0	17.850
SOL 51124-18-1/2 OR	078.1171.646	200	24x1.5	30	27	50.0	27.0	12.0	2.5	18.72x2.62	21.5	13.0	16.450

Für Zollrohre

Pour tubes pouces

For inch tubes

SOL 51124-6,35-1/8 OR	078.1171.135	400	10x1.0	14	14	31.5	14.5	8.0	1.0	8.73x1.78	14.5	4.5	3.000
SOL 51124-6,35-1/4 OR	078.1171.140	400	10x1.0	14	19	35.0	18.5	10.0	1.5	11.1x1.78	16.0	4.5	4.300
SOL 51124-9,52-1/4 OR	078.1171.230	330	14x1.0	19	19	40.0	18.5	10.0	1.5	11.1x1.78	17.0	7.0	6.300
SOL 51124-9,52-3/8 OR	078.1171.235	330	14x1.0	19	22	41.0	22.5	10.0	1.5	14.0x1.78	18.5	8.0	7.600
SOL 51124-12,7-1/2 OR	078.1171.434	330	20x1.5	27	27	49.0	27.0	12.0	2.5	18.72x2.62	22.0	11.0	14.700

Umrechnung für "d" bei Zollrohren:

6,35 = 1/4

9,52 = 3/8

12,7 = 1/2

Conversion de "d" pour tubes en pouces:

6,35 = 1/4

9,52 = 3/8

12,7 = 1/2

Conversion for "d" for inch tubes:

6,35 = 1/4

9,52 = 3/8

12,7 = 1/2

Einbauempfehlung:

Conseil de montage:

Recommendation for installation:

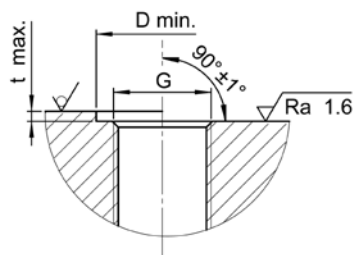
Einsatztemperaturbereich: -20 °C bis +200 °C

Die Vorteile dieser O-Ringabdichtung:

- keine Dichtmittelreste in Geräten
- einwandfreie Abdichtung
- keine Beschädigung von Geräten durch konische Gewinde
- schnelle Montage

Conovor patentierte O-Ring Abdichtung

Plage de température de service: -20 °C à +200 °C

Les avantages de cette étanchéité à joint torique:

- aucun reste de scellant dans les équipements
- une étanchéité parfaite
- aucun endommagement de l'équipement par le filetage conique
- facilité d'installation

Etanchéité à joint torique brevetée Conovor

Operating temperature range: -20 °C to +200 °C

Advantages of this O-ring seal:

- no sealing residues in devices
- perfect seal
- no damage to devices due to tapered thread
- rapid assembly

Conovor patented O-ring seal

d=Rohrassens-ø
e=kleinste Bohrung
L=Mass in montiertem Zustand

d=ø extérieur du tube
e=ø-min. de passage
L=après montage

d=tube outside diameter
e=minimum bore
L=installed length

Gerade Aufschraubverschraubung

Union femelle

Female adaptor union

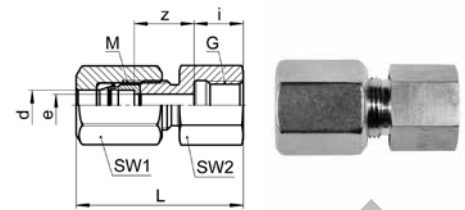

SOL 51221

Type -d -G	Mat.-Nr.	bar	M	SW1	SW2	L	i	z	e	kg/100
Für metrische Rohre G=Rohrgewinde (zylindrisch)	Pour tubes métriques G=Filetage-gaz BSP (cylindrique)			For metric tubes G=BSP thread (parallel)						
SOL 51221-6-1/8	078.1201.100	400	10x1.0	14	14	32.0	10.0	12.0	4.5	3.000
SOL 51221-6-1/4	078.1201.110	400	10x1.0	14	17	34.0	11.0	13.0	4.5	3.700
SOL 51221-6-3/8	078.1201.120	400	10x1.0	14	22	35.0	12.0	13.0	4.5	5.200
SOL 51221-6-1/2	078.1201.125	400	10x1.0	14	27	41.0	14.0	17.0	4.5	9.000
SOL 51221-8-1/4	078.1201.170	330	12x1.0	17	17	35.5	11.0	14.0	6.5	4.500
SOL 51221-10-1/4	078.1201.270	330	14x1.0	19	17	37.5	11.0	14.0	8.5	5.600
SOL 51221-10-3/8	078.1201.280	330	14x1.0	19	22	38.5	12.0	14.0	8.5	6.900
SOL 51221-10-1/2	078.1201.285	330	14x1.0	19	27	40.5	14.0	14.0	8.5	9.000
SOL 51221-12-1/4	078.1201.380	330	16x1.0	22	17	38.5	11.0	14.0	10.0	6.900
SOL 51221-12-3/8	078.1201.390	330	16x1.0	22	22	39.5	12.0	14.0	10.0	8.200
SOL 51221-12-1/2	078.1201.400	330	16x1.0	22	27	41.5	14.0	14.0	10.0	10.200
SOL 51221-15-1/2	078.1201.534	250	20x1.5	27	27	45.5	14.0	16.5	13.0	13.700
SOL 51221-16-1/2	078.1201.566	200	24x1.5	30	27	49.0	14.0	16.5	14.0	17.500
SOL 51221-18-1/2	078.1201.646	200	24x1.5	30	27	47.0	14.0	16.5	15.0	16.100
Für Zollrohre	Pour tubes pouces			For inch tubes						
SOL 51221-6,35-1/8	078.1201.135	400	10x1.0	14	14	32.0	10.0	12.0	4.5	3.200
SOL 51221-6,35-1/4	078.1201.140	400	10x1.0	14	17	34.0	11.0	13.0	4.5	3.900
SOL 51221-6,35-3/8	078.1201.145	400	10x1.0	14	22	35.0	12.0	13.0	4.5	5.400
SOL 51221-6,35-1/2	078.1201.150	400	10x1.0	14	27	41.0	14.0	17.0	4.5	9.300
SOL 51221-9,52-1/4	078.1201.230	330	14x1.0	19	17	38.0	11.0	14.0	8.0	6.000
SOL 51221-9,52-3/8	078.1201.235	330	14x1.0	19	22	39.0	12.0	14.0	8.0	7.500
SOL 51221-9,52-1/2	078.1201.240	330	14x1.0	19	27	40.0	14.0	14.0	8.0	9.600
SOL 51221-12,7-1/2	078.1201.434	330	20x1.5	27	27	40.0	14.0	16.5	11.0	14.700

Umrechnung für "d" bei Zollrohren:

 6,35 = 1/4
 9,52 = 3/8
 12,7 = 1/2

Conversion de "d" pour tubes en pouces:

 6,35 = 1/4
 9,52 = 3/8
 12,7 = 1/2

Conversion for "d" for inch tubes:

 6,35 = 1/4
 9,52 = 3/8
 12,7 = 1/2

Verbindungsrippel

Pièce folle

Tube stub

SOL 51300

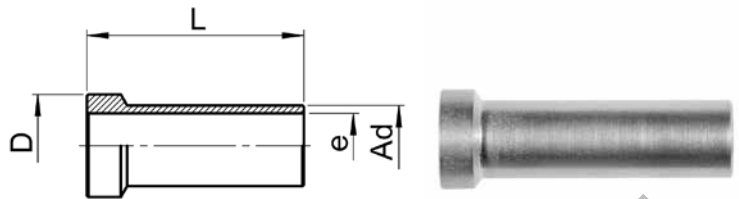

Type -Ad	Mat.-Nr.	bar	L	D	e	kg/100
SOL 51300-A6	076.1300.060	400	32.0	8.9	3.8	0.560
SOL 51300-A8	076.1300.080	330	35.0	10.9	5.6	0.900
SOL 51300-A10	076.1300.100	330	40.0	12.9	6.5	1.700
SOL 51300-A12	076.1300.120	330	32.0	14.9	8.0	2.000
SOL 51300-A15	076.1300.150	250	37.0	18.4	11.0	2.800
SOL 51300-A16	076.1300.160	200	41.0	22.4	12.0	4.300
SOL 51300-A18	076.1300.180	200	41.0	22.4	14.0	4.100

Anwendungsbeispiele:

Exemples d'utilisation:

Sample combinations:

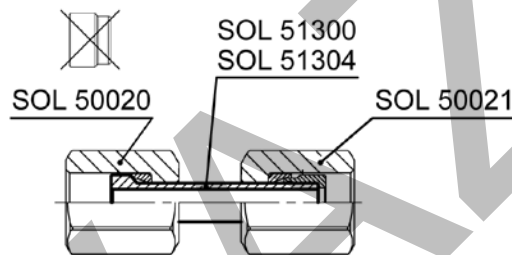

Werden die Verbindungsrippel mit einer Anschlussmutter und einem Armaturenanschluss (Anschlussmutter und Klemmring) verbunden, ergibt dies eine einstellbare Verschraubung.

Auch vormontiert erhältlich (SOL 51325 / SOL 51326).

Montagehinweis: Auf Seite des angedrehten Klemmringes (links im Bild) Anschlussmutter mit 1/4 Umdrehung anziehen. Auf Seite des Armaturenanschlusses (rechts im Bild) Anschlussmutter mit 1 3/4 Umdrehung anziehen.

Si l'insert de la pièce folle est relié à un écrou et à un écrou de raccordement (écrou et bague de serrage), cela fournit une union orientable.

Aussi disponible pré-assemblé (SOL 51325 / SOL 51326).

Note d'installation: Serrez l'écrou sur le côté de la bague de serrage tournée (à gauche sur l'illustr.) de 1/4 de tour. Serrez l'écrou de l'autre côté (à droite sur l'illustr.) de 1 3/4 tour.

If the tube stubs are coupled with a union nut and a nut connection (union nut and compression ferrule), an adjustable union is produced.

Also available pre-assembled (SOL 51325 / SOL 51326).

Assembly information: Tighten the union nut on the side of the turned compression ferrule (left in pict.) with 1/4 turn. Tighten the union nut on the other side (right in pict.) 1 3/4 turns.

Anwendungsbeispiele:

Exemples d'utilisation:

Sample combinations:

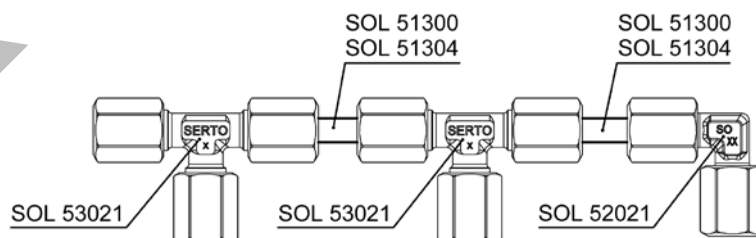

Mit der einstellbaren Verschraubung lassen sich Formteile mit dem gleichen Anschlussgewinde verbinden.

Avec l'union orientable, il est possible de connecter des raccords de même filetages.

With the adjustable union, parts with the same connecting thread can be connected.

Verbindungsrippel

radial demontierbar

Pièce folle

démontable radialement

Tube stub

radial dismantling

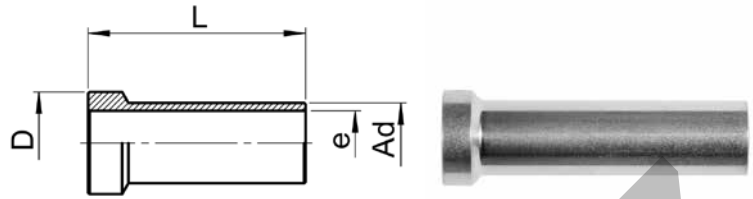
SOL 51304

Type -Ad	Mat.-Nr.	bar	L	D	e	kg/100
SOL 51304-A6	076.1310.060	400	36.0	8.9	3.8	0.610
SOL 51304-A8	076.1310.080	330	38.0	10.9	5.6	0.940
SOL 51304-A10	076.1310.100	330	42.0	12.9	6.5	1.700
SOL 51304-A12	076.1310.120	330	44.0	14.9	8.0	2.600

Anwendungsbeispiele:

Exemples d'utilisation:

Sample combinations:

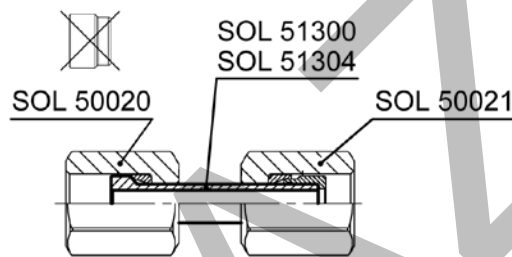

Werden die Verbindungsrippel mit einer Anschlussmutter und einem Armaturenanschluss (Anschlussmutter und Klemmring) verbunden, ergibt dies eine einstellbare Verschraubung.

Auch vormontiert erhältlich (SOL 51325 / SOL 51326).

Montagehinweis: Auf Seite des angedrehten Klemmringes (links im Bild) Anschlussmutter mit 1/4 Umdrehung anziehen. Auf Seite des Armaturenanschlusses (rechts im Bild) Anschlussmutter mit 1 3/4 Umdrehung anziehen.

Si l'insert de la pièce folle est relié à un écrou et à un écrou de raccordement (écrou et bague de serrage), cela fournit une union orientable.

Aussi disponible pré-assemblé (SOL 51325 / SOL 51326).

Note d'installation: Serrez l'écrou sur le côté de la bague de serrage tournée (à gauche sur l'illustr.) de 1/4 de tour. Serrez l'écrou de l'autre côté (à droite sur l'illustr.) de 1 3/4 tour.

If the tube stubs are coupled with a union nut and a nut connection (union nut and compression ferrule), an adjustable union is produced.

Also available pre-assembled (SOL 51325 / SOL 51326).

Assembly information: Tighten the union nut on the side of the turned compression ferrule (left in pict.) with 1/4 turn. Tighten the union nut on the other side (right in pict.) 1 3/4 turns.

Anwendungsbeispiele:

Exemples d'utilisation:

Sample combinations:

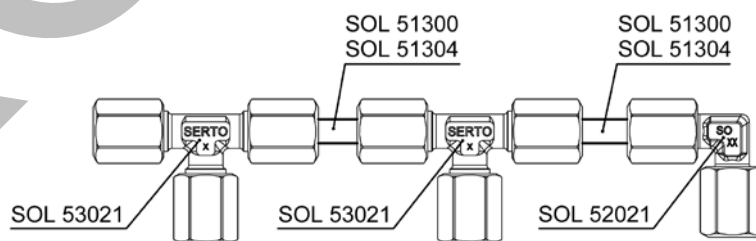

Mit der einstellbaren Verschraubung lassen sich Formteile mit dem gleichen Anschlussgewinde verbinden.

Avec l'union orientable, il est possible de connecter des raccords de même filetages.

With the adjustable union, parts with the same connecting thread can be connected.

Einstellbare Verschraubung

Union orientable

Adjustable union

SOL 51325

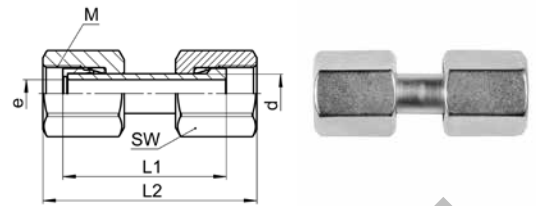

Type -d	Mat.-Nr.	bar	M	SW	L1	L2	e	kg/100
SOL 51325-A6	078.1320.060	400	10x1.0	14	33.0	45.5	3.8	4.000
SOL 51325-A8	078.1320.080	330	12x1.0	17	36.0	49.5	5.6	6.030
SOL 51325-A10	078.1320.100	330	14x1.0	19	41.0	55.5	6.5	8.380
SOL 51325-A12	078.1320.120	330	16x1.0	22	33.0	47.5	8.0	11.150
SOL 51325-A15	078.1320.150	250	20x1.5	27	38.5	55.0	11.0	18.820
SOL 51325-A16	078.1320.160	200	24x1.5	30	42.5	59.0	12.0	24.440
SOL 51325-A18	078.1320.180	200	24x1.5	30	42.5	59.0	14.0	22.940

Einstellbare Verschraubung

radial demontierbar

Union orientable

démontable radialement

Adjustable union

radial dismantling

SOL 51326

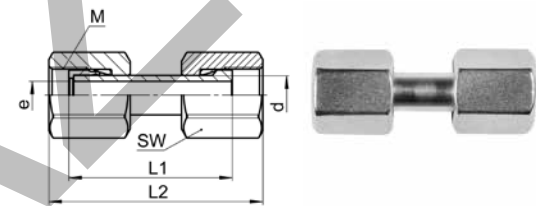

Type -d	Mat.-Nr.	bar	M	SW	L1	L2	e	kg/100
SOL 51326-A6	078.1330.060	400	10x1.0	14	37.0	49.5	3.8	4.050
SOL 51326-A8	078.1330.080	330	12x1.0	17	39.0	53.0	5.6	6.090
SOL 51326-A10	078.1330.100	330	14x1.0	19	43.0	57.0	6.5	8.380
SOL 51326-A12	078.1330.120	330	16x1.0	22	45.0	59.5	8.0	11.750

Mit der einstellbaren Verschraubung lassen sich Formteile mit dem gleichen Anschlussgewinde verbinden.

Montagehinweis: Beide Anschlussmutter mit 1/4 Umdrehung anziehen. Wir empfehlen eine zusätzliche Schmierung auf der Planfläche.

Avec l'union orientable, il est possible de connecter des raccords de même filetages.

Note d'installation: Serrez les deux écrous de 1/4 de tour. Nous recommandons une lubrification supplémentaire sur la surface plane.

With the adjustable union, parts with the same connecting thread can be connected.

Assembly information: Tighten both union nuts with 1/4 turn. We recommend additional lubrication on the plane surface.

Anschweisverschraubung

Union avec embout à souder

Weld-on union

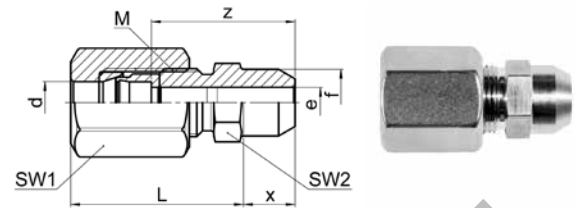

SOL 51429

Type -d	Mat.-Nr.	bar	M	SW1	SW2	L	f	x	z	e	kg/100
Für metrische Rohre	Pour tubes métriques			For metric tubes							
SOL 51429-6	078.1400.060	400	10x1.0	14	10	31.0	9.8	8.0	21.0	4.5	2.500
SOL 51429-8	078.1400.080	330	12x1.0	17	12	32.5	11.8	8.0	22.0	6.5	3.700
SOL 51429-10	078.1400.100	330	14x1.0	19	14	35.5	13.8	8.0	23.0	8.5	4.800
SOL 51429-12	078.1400.120	330	16x1.0	22	17	37.5	16.0	8.0	24.0	10.0	6.700
SOL 51429-15	078.1400.150	250	20x1.5	27	22	44.5	19.0	10.0	29.5	13.0	11.600
SOL 51429-16	078.1400.160	200	24x1.5	30	24	50.0	22.0	11.0	31.5	15.0	17.100
SOL 51429-18	078.1400.180	200	24x1.5	30	24	48.0	22.0	11.0	31.5	15.0	15.600
Für Zollrohre	Pour tubes pouces			For inch tubes							
SOL 51429-6,35	078.1400.063	400	10x1.0	14	10	31.0	9.8	8.0	21.0	4.5	2.600
SOL 51429-9,52	078.1400.095	330	14x1.0	19	14	35.5	13.8	8.0	23.0	8.0	5.100
SOL 51429-12,7	078.1400.127	330	20x1.5	27	22	44.5	19.0	10.0	29.5	11.0	12.600

Umrechnung für "d" bei Zollrohren:

6,35 = 1/4
9,52 = 3/8
12,7 = 1/2

Conversion de "d" pour tubes en pouces:

6,35 = 1/4
9,52 = 3/8
12,7 = 1/2

Conversion for "d" for inch tubes:

6,35 = 1/4
9,52 = 3/8
12,7 = 1/2

Nach dem Anschweißen die von SERTO empfohlenen Schmierstellen mit dem Spezial-Schmieröl AC 850 nochmals schmieren.

Après le soudage, graissez les points de lubrification nécessaires, conformément aux recommandations de SERTO, avec l'huile de lubrification spéciale AC 850.

After welding, grease the necessary lubrication points as recommended by SERTO with the special lubrication oil AC 850.

Gerade Schottverschraubung

Durchführungslänge max. 5 mm

Union double traversée de cloison

pour cloison max. 5 mm

Panel mount union

max. panel thickness 5 mm

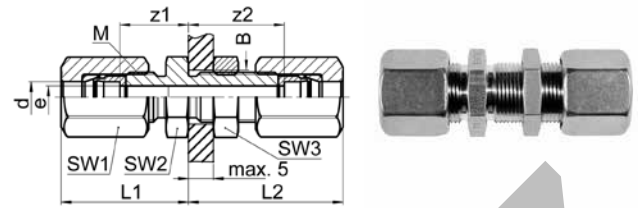

SOL 51521

Type -d	Mat.-Nr.	bar	M	SW1	SW2	SW3	L1	L2	B	z1	z2	e	kg/100
Für metrische Rohre	Pour tubes métriques						For metric tubes						
SOL 51521-6	078.1500.060	400	10x1.0	14	14	14	22.5	28.0	10.5	13.5	19.0	4.5	5.300
SOL 51521-8	078.1500.080	330	12x1.0	17	17	17	24.5	30.5	12.5	15.0	21.0	6.5	8.100
SOL 51521-10	078.1500.100	330	14x1.0	19	19	19	28.0	32.5	14.5	15.5	21.0	8.5	10.300
SOL 51521-12	078.1500.120	330	16x1.0	22	22	22	28.5	34.5	16.5	16.0	21.0	10.0	14.100

Für Zollrohre	Pour tubes pouces						For inch tubes						
SOL 51521-6,35	078.1500.063	400	10x1.0	14	14	14	22.5	28.0	10.5	13.5	19.0	4.5	5.600
SOL 51521-9,52	078.1500.095	330	14x1.0	19	19	19	28.0	32.5	14.5	15.5	21.0	8.0	11.200

Umrechnung für "d" bei Zollrohren:

6,35 = 1/4

9,52 = 3/8

Conversion de "d" pour tubes en pouces:

6,35 = 1/4

9,52 = 3/8

Conversion for "d" for inch tubes:

6,35 = 1/4

9,52 = 3/8

Sechskantmutter siehe SO 50006 METR

Ecrou à six pans voir SO 50006 METR

Hexagon nut see SO 50006 METR

Gerade Schottverschraubung

Durchführungslänge max. 16 mm

Union double traversée de cloison

pour cloison max. 16 mm

Panel mount union

max. panel thickness 16 mm

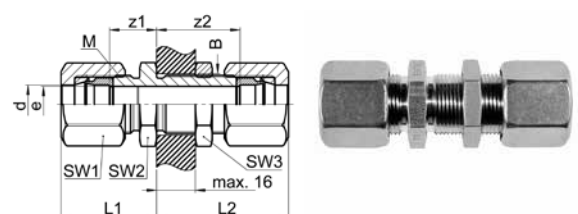

SOL 51524

Type -d	Mat.-Nr.	bar	M	SW1	SW2	SW3	L1	L2	B	z1	z2	e	kg/100
SOL 51524-16	078.1540.160	200	24x1.5	30	30	30	38.0	53.0	24.5	19.5	34.5	14.0	36.000
SOL 51524-18	078.1540.180	200	24x1.5	30	30	30	37.0	52.0	24.5	19.5	34.5	15.0	34.200

Sechskantmutter siehe SO 50006 METR

Ecrou à six pans voir SO 50006 METR

Hexagon nut see SO 50006 METR

d=Rohrussen-ø
e=kleinste Bohrung
L=Mass in montiertem Zustand

d=ø extérieur du tube
e=ø-min. de passage
L=après montage

d=tube outside diameter
e=minimum bore
L=installed length

Einstellbare Einschraubverschraubung

Union mâle orientable

Adjustable male adaptor union

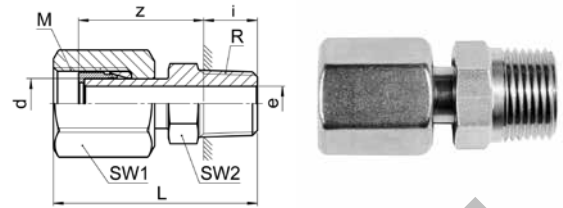

SOL 51625

Type -d -R	Mat.-Nr.	bar	M	SW1	SW2	L	i	z	e	kg/100
R=Rohrgewinde (kegelig)										
			R=Filetage-gaz BSP (conique)							
								R=BSP thread (tapered)		
SOL 51625-A6-1/8	078.1620.100	400	10x1.0	14	12	34.5	5.0	23.0	4.0	2.600
SOL 51625-A6-1/4	078.1620.110	400	10x1.0	14	14	39.5	8.0	25.0	4.0	3.350
SOL 51625-A8-1/8	078.1620.160	330	12x1.0	17	12	37.0	5.0	25.0	6.0	3.160
SOL 51625-A8-1/4	078.1620.170	330	12x1.0	17	14	41.0	8.0	26.0	6.0	4.160
SOL 51625-A10-1/4	078.1620.270	330	14x1.0	19	14	43.0	8.0	28.0	7.0	4.760
SOL 51625-A10-3/8	078.1620.280	330	14x1.0	19	17	43.0	8.0	28.0	7.0	6.470
SOL 51625-A10-1/2	078.1620.285	330	14x1.0	19	22	47.0	10.0	30.0	7.0	9.200
SOL 51625-A12-1/4	078.1620.380	330	16x1.0	22	14	44.5	8.0	29.0	8.0	5.790
SOL 51625-A12-3/8	078.1620.390	330	16x1.0	22	17	44.5	8.0	29.0	9.0	7.290
SOL 51625-A12-1/2	078.1620.400	330	16x1.0	22	22	49.5	10.0	32.0	9.0	9.680
SOL 51625-A15-1/2	078.1620.534	250	20x1.5	27	22	54.0	10.0	35.5	12.0	12.750

Montagehinweis: Anschlussmutter mit 1/4 Umdrehung anziehen.
Wir empfehlen eine zusätzliche Schmierung auf der Planfläche.

Note d'installation: Serrez l'écrou de 1/4 de tour.
Nous recommandons une lubrification supplémentaire sur la surface plane.

Assembly information: Tighten the union nut with 1/4 turn.
We recommend additional lubrication on the plane surface.

**Reduktions-
Einstellverschraubung**
Raccord de réduction orientable
Adjustable reduction union

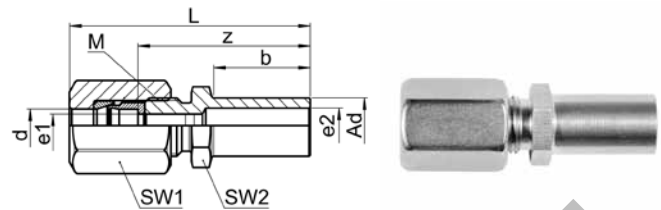
SOL 51821

Type -Ad -d	Mat.-Nr.	bar	M	SW1	SW2	L	b	z	e1	e2	kg/100
SOL 51821-A10-6	078.1800.175	330	10x1.0	14	12	39.5	17.0	29.5	4.5	6.5	2.530
SOL 51821-A12-8	078.1800.225	330	12x1.0	17	14	44.0	19.0	33.5	6.5	8.5	4.060
SOL 51821-A15-10	078.1800.410	250	14x1.0	19	17	48.5	21.0	36.0	8.5	11.5	5.430
SOL 51821-A18-12	078.1800.580	200	16x1.0	22	19	52.5	24.0	40.0	10.0	14.5	7.470
SOL 51821-A22-15	078.1800.745	200	20x1.5	27	24	58.5	25.0	43.5	13.0	19.0	12.010

**Reduktions-Einstellverschraubung
vormontiert**
**Raccord de réduction orientable
prémonté**
**Adjustable reduction union pre-
assembled**

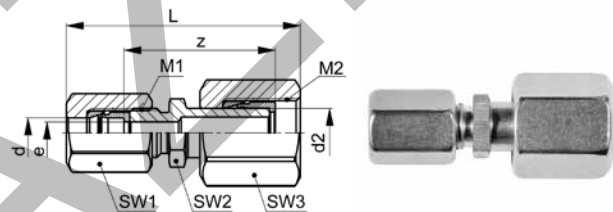
SOL 51825

Type -d2 -d	Mat.-Nr.	bar	M1	M2	SW1	SW2	SW3	L	z	e	kg/100
SOL 51825-A10-6	078.1820.175	330	10x1.0	14x1.0	14	12	19	47.5	30.5	4.5	4.310
SOL 51825-A12-8	078.1820.225	330	12x1.0	16x1.0	17	14	22	52.0	34.5	6.5	6.270
SOL 51825-A15-10	078.1820.410	250	14x1.0	20x1.5	19	17	27	56.5	37.5	8.5	9.640
SOL 51825-A18-12	078.1820.580	200	16x1.0	24x1.5	22	19	30	62.5	41.0	10.0	12.520

Montagehinweis: Anschlussmutter auf Seite Einstellteil mit 1/4 Umdrehung anziehen. Wir empfehlen eine zusätzliche Schmierung auf der Planfläche.

Note d'installation: Serrez l'écrou du côté orientable de 1/4 de tour. Nous recommandons une lubrification supplémentaire sur la surface plane.

Assembly information: Tighten the union nut on the adjustable side with 1/4 turn. We recommend additional lubrication on the plane surface.

d=Rohrassen- \varnothing
 Ad=Aussen- \varnothing der Andrehung
 e=kleinste Bohrung
 L=Mass in montiertem Zustand

d= \varnothing extérieur du tube
 Ad= \varnothing extérieur de la portée cylindrique
 e= \varnothing -min. de passage
 L=après montage

d=tube outside diameter
 Ad=outside diameter of cyl. stub
 e=minimum bore
 L=installed length

Winkelverschraubung

Coude

Elbow union

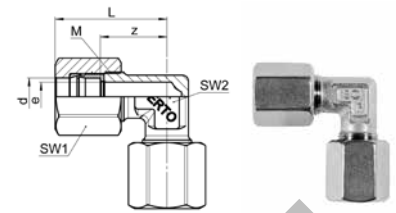

SOL 52021

Type -d	Mat.-Nr.	bar	M	SW1	SW2	L	z	e	kg/100
Für metrische Rohre	Pour tubes métriques			For metric tubes					
SOL 52021-6	078.2000.060	400	10x1.0	14	9	26.0	16.0	4.5	4.450
SOL 52021-8	078.2000.080	330	12x1.0	17	10	29.0	18.0	6.5	6.640
SOL 52021-10	078.2000.100	330	14x1.0	19	12	33.5	20.5	8.5	8.880
SOL 52021-12	078.2000.120	330	16x1.0	22	14	35.5	21.5	9.5	12.310
SOL 52021-15	078.2000.150	250	20x1.5	27	17	39.0	24.0	13.0	20.210
SOL 52021-16	078.2000.160	200	24x1.5	30	22	45.0	26.0	14.0	28.900
SOL 52021-18	078.2000.180	200	24x1.5	30	22	43.0	26.5	15.0	26.550
Für Zollrohre	Pour tubes pouces			For inch tubes					
SOL 52021-6,35	078.2000.063	400	10x1.0	14	9	26.0	16.0	4.5	4.600
SOL 52021-9,52	078.2000.095	330	14x1.0	19	12	33.5	20.5	8.0	9.500
SOL 52021-12,7	078.2000.127	330	20x1.5	27	17	39.5	24.0	11.0	22.100

Umrechnung für "d" bei Zollrohren:

6,35 = 1/4

9,52 = 3/8

12,7 = 1/2

Conversion de "d" pour tubes en pouces:

6,35 = 1/4

9,52 = 3/8

12,7 = 1/2

Conversion for "d" for inch tubes:

6,35 = 1/4

9,52 = 3/8

12,7 = 1/2

Winkel-Einschraubverschraubung

Coude mâle

Male adaptor elbow union

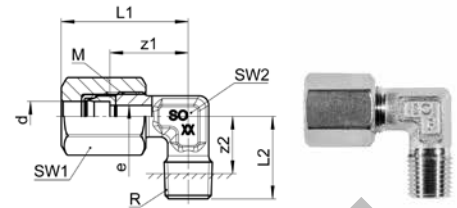

SOL 52421

Type -d -R	Mat.-Nr.	bar	M	SW1	SW2	L1	L2	z1	z2	e	kg/100
Für metrische Rohre R=Rohrgewinde (kegelig)	Pour tubes métriques R=Filetage-gaz BSP (conique)	For metric tubes R=BSP thread (tapered)									
SOL 52421-6-1/8	078.2401.100	400	10x1.0	14	9	26.0	17.5	16.0	13.5	4.5	2.900
SOL 52421-6-1/4	078.2401.110	400	10x1.0	14	10	28.0	22.5	18.0	18.5	4.5	4.200
SOL 52421-8-1/8	078.2401.160	330	12x1.0	17	10	28.5	18.0	18.0	14.0	6.0	4.000
SOL 52421-8-1/4	078.2401.170	330	12x1.0	17	10	28.5	22.5	18.0	18.5	6.5	4.700
SOL 52421-8-3/8	078.2401.180	330	12x1.0	17	14	32.5	26.0	22.0	19.5	6.5	6.800
SOL 52421-10-1/4	078.2401.270	330	14x1.0	19	12	33.0	25.0	20.5	19.0	8.5	5.700
SOL 52421-12-1/4	078.2401.380	330	16x1.0	22	14	35.0	25.5	21.5	19.0	8.5	7.500
SOL 52421-12-3/8	078.2401.390	330	16x1.0	22	14	35.0	26.0	21.5	19.5	10.0	8.300
SOL 52421-15-1/2	078.2401.534	250	20x1.5	27	17	39.0	29.5	24.0	21.5	13.0	13.300

Für Zollrohre	Pour tubes pouces	For inch tubes									
SOL 52421-6,35-1/8	078.2401.135	400	10x1.0	14	9	25.0	17.5	16.0	13.5	4.5	3.000
SOL 52421-6,35-1/4	078.2401.140	400	10x1.0	14	10	27.0	22.5	18.0	18.5	4.5	4.100
SOL 52421-9,52-1/4	078.2401.230	330	14x1.0	19	12	33.5	25.0	20.5	19.0	8.0	3.900
SOL 52421-12,7-1/2	078.2401.434	330	20x1.5	27	17	39.5	29.5	24.0	21.5	11.0	14.500

Umrechnung für "d" bei Zollrohren:

 6,35 = 1/4
 9,52 = 3/8
 12,7 = 1/2

Conversion de "d" pour tubes en pouces:

 6,35 = 1/4
 9,52 = 3/8
 12,7 = 1/2

Conversion for "d" for inch tubes:

 6,35 = 1/4
 9,52 = 3/8
 12,7 = 1/2

Winkel Einschraubverschraubung NPT

Coude mâle NPT

Male adaptor elbow union NPT

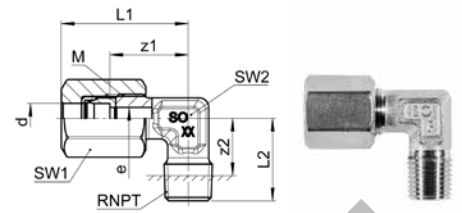

SOL 52421 NPT

Type -d -RNPT	Mat.-Nr.	bar	M	SW1	SW2	L1	L2	z1	z2	e	kg/100
Für metrische Rohre RNPT=NPT Gewinde	Pour tubes métriques RNPT=Filetage NPT	For metric tubes RNPT=NPT thread									
SOL 52421-6-1/8 NPT	078.2402.100	400	10x1.0	14	9	26.0	17.5	16.0	13.5	4.5	1.900
SOL 52421-8-1/4 NPT	078.2402.170	330	12x1.0	17	10	28.0	22.5	18.0	18.5	6.5	3.300
SOL 52421-10-1/4 NPT	078.2402.270	330	14x1.0	19	12	33.0	25.0	20.5	19.0	8.5	4.200
SOL 52421-12-3/8 NPT	078.2402.390	330	16x1.0	22	14	35.0	26.0	21.5	20.0	10.0	5.700
SOL 52421-15-1/2 NPT	078.2402.534	250	20x1.5	27	17	39.0	29.5	24.0	21.5	13.0	10.200

Für Zollrohre	Pour tubes pouces	For inch tubes									
SOL 52421-6,35-1/8 NPT	078.2402.135	400	10x1.0	14	9	27.0	17.5	16.5	13.5	4.5	3.000
SOL 52421-9,52-1/4 NPT	078.2402.230	330	14x1.0	19	12	33.5	25.0	21.0	19.0	8.0	6.200
SOL 52421-12,7-1/2 NPT	078.2402.434	330	20x1.5	27	17	39.5	29.5	24.5	21.5	11.0	14.900

Umrechnung für "d" bei Zollrohren:

6,35 = 1/4

9,52 = 3/8

12,7 = 1/2

Conversion de "d" pour tubes en pouces:

6,35 = 1/4

9,52 = 3/8

12,7 = 1/2

Conversion for "d" for inch tubes:

6,35 = 1/4

9,52 = 3/8

12,7 = 1/2

Einstellbare Winkelverschraubung

Coude orientable

Adjustable elbow union

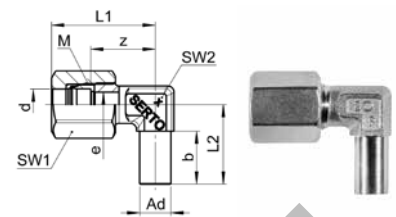

SOL 52621

Type -d -Ad	Mat.-Nr.	bar	M	SW1	SW2	L1	L2	b	z	e	kg/100	
Für metrische Rohre	Pour tubes métriques					For metric tubes						
SOL 52621-6-A6	078.2600.060	400	10x1.0	14	9	26.0	18.0	12.5	16.0	4.0	2.570	
SOL 52621-8-A8	078.2600.080	330	12x1.0	17	10	28.5	23.0	15.0	18.0	6.0	3.880	
SOL 52621-10-A10	078.2600.100	330	14x1.0	19	12	33.0	25.5	17.0	20.5	7.0	5.370	
SOL 52621-12-A12	078.2600.120	330	16x1.0	22	14	35.0	26.5	18.0	21.5	9.0	7.890	
SOL 52621-15-A15	078.2600.150	250	20x1.5	27	17	39.0	30.0	19.5	24.0	12.0	13.450	

Für Zollrohre	Pour tubes pouces	For inch tubes									
SOL 52621-6,35-A6	078.2600.067	400	10x1.0	14	9	26.5	18.0	12.5	16.0	4.0	4.600

Umrechnung für "d" bei Zollrohren:
6,35 = 1/4

Conversion de "d" pour tubes en pouces:
6,35 = 1/4

Conversion for "d" for inch tubes:
6,35 = 1/4

Anwendungsbeispiele:

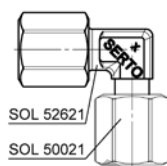

Exemples d'utilisation:

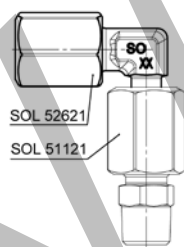

Sample combinations:

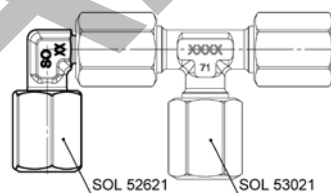

Mögliche Kombinationen:

- mit Armaturenanschluss zu einstellbaren Winkelverschraubungen
- mit Verschraubungen zu einstellbaren Verschraubungen
- mit Einschraubverschraubungen zu einstellbaren Einschraubwinkeln. Gegenüber dem Einschraubwinkel lässt sich diese Kombination einfacher einstellen, da Einschrauben und Ausrichten getrennt voneinander vorgenommen werden.

Combinaisons possibles:

- avec écrou de raccordement ça donne des raccords coudé orientables
- avec raccords ça donne des raccords orientables
- avec une union mâle ça donne un coude fileté orientable. Par rapport au coude orientable, cette combinaison est facile à régler, puisque le vissage et l'alignement sont réalisés séparément l'un de l'autre.

Possible combinations:

- with a nut connection to adjustable elbow unions
- with a union to adjustable unions
- with a male adaptor union to adjustable male adaptor elbow unions. This combination is simpler to produce, as screwing in and alignment are carried out separately.

d=Rohraussen-ø
Ad=Aussen-ø der Andrehung
e=kleinste Bohrung
L=Mass in montiertem Zustand

d=ø extérieur du tube
Ad=ø extérieur de la portée cylindrique
e=ø-min. de passage
L=après montage

d=tube outside diameter
Ad=outside diameter of cyl. stub
e=minimum bore
L=installed length

Einstellbare Winkelverschraubung vormontiert

Coude orientable prémonté

Adjustable elbow union pre-assembled

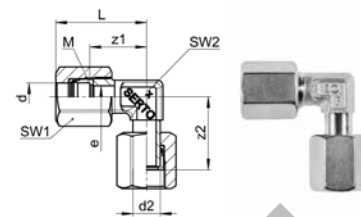

SOL 52625

Type -d -d2	Mat.-Nr.	bar	M	SW1	SW2	L	z1	z2	e	kg/100
SOL 52625-6-A6	078.2620.060	400	10x1.0	14	9	26.0	16.0	19.0	4.0	4.220
SOL 52625-8-A8	078.2620.080	330	12x1.0	17	10	28.5	18.0	24.0	6.0	6.380
SOL 52625-10-A10	078.2620.100	330	14x1.0	19	12	33.0	20.5	26.5	7.0	8.640
SOL 52625-12-A12	078.2620.120	330	16x1.0	22	14	35.0	21.5	27.5	9.0	12.060
SOL 52625-15-A15	078.2620.150	250	20x1.5	27	17	39.0	24.0	31.0	12.0	15.340

Montagehinweis: Anschlussmutter auf Seite Einstellteil mit 1/4 Umdrehung anziehen.

Wir empfehlen eine zusätzliche Schmierung auf der Planfläche.

Note d'installation: Serrez l'écrou du côté orientable de 1/4 de tour.

Nous recommandons une lubrification supplémentaire sur la surface plane.

Assembly information: Tighten the union nut on the adjustable side with 1/4 turn.

We recommend additional lubrication on the plane surface.

Winkel-Schottverschraubung

Durchführungslänge max. 20 mm

Coude traversée de cloison

pour cloison max. 20 mm

Panel mount elbow union

max. panel thickness 20 mm

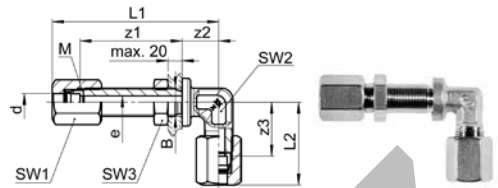

SOL 52721

Type-d	Mat.-Nr.	bar	M	SW1	SW2	SW3	L1	L2	B	z1	z2	z3	e	kg/100	
Für metrische Rohre		Pour tubes métriques						For metric tubes							
SOL 52721-6	078.2700.060	400	10x1.0	14	12	14	59.0	29.0	10.5	36.0	13.0	19.0	4.5	6.980	
SOL 52721-8	078.2700.080	330	12x1.0	17	12	17	59.5	29.5	12.5	36.0	13.0	19.0	5.5	9.450	
SOL 52721-10	078.2700.100	330	14x1.0	19	12	19	65.5	35.5	14.5	36.0	17.0	23.0	7.5	12.350	
SOL 52721-12	078.2700.120	330	16x1.0	22	14	22	67.0	37.0	16.5	37.0	17.0	24.0	8.5	17.060	
SOL 52721-15	078.2700.150	250	20x1.5	27	19	27	78.0	44.0	20.5	40.0	23.0	29.0	13.0	28.600	
SOL 52721-16	078.2700.160	200	24x1.5	30	24	30	83.0	52.0	24.5	42.5	22.0	33.0	14.0	30.600	
SOL 52721-18	078.2700.180	200	24x1.5	30	24	30	81.0	50.0	24.5	42.5	22.0	33.5	15.0	29.700	

Für Zollrohre		Pour tubes pouces						For inch tubes							
SOL 52721-6,35	078.2700.063	400	10x1.0	14	12	14	60.0	30.0	10.5	36.0	13.0	19.0	4.5	7.300	
SOL 52721-9,52	078.2700.095	330	14x1.0	19	12	19	66.0	36.0	14.5	36.0	17.0	23.0	7.5	13.800	
SOL 52721-12,7	078.2700.127	330	20x1.5	27	19	27	78.5	44.5	20.5	40.5	23.0	29.5	11.0	31.800	

Umrechnung für "d" bei Zollrohren:

6,35 = 1/4
9,52 = 3/8
12,7 = 1/2

Conversion de "d" pour tubes en pouces:

6,35 = 1/4
9,52 = 3/8
12,7 = 1/2

Conversion for "d" for inch tubes:

6,35 = 1/4
9,52 = 3/8
12,7 = 1/2

Sechskantmutter siehe SO 50006 METR

Ecrou à six pans voir SO 50006 METR

Hexagon nut see SO 50006 METR

Schwenkverschraubung

Coude banjo

Single banjo

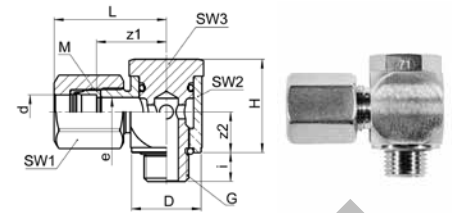

SOL 52824

Type -d -G	Mat.-Nr.	bar	M	SW1	SW2	SW3	L	D	H	i	z1	z2	e	kg/100
Für metrische Rohre G=Rohrgewinde (zylindrisch)														
SOL 52824-6-1/8	078.2841.100	400	10x1.0	14	16	14	28.0	18.0	21.0	7.5	18.0	10.5	4.5	6.280
SOL 52824-8-1/8	078.2841.160	330	12x1.0	17	19	14	29.0	18.0	22.0	6.5	19.0	10.5	4.5	8.300
SOL 52824-8-1/4	078.2841.170	330	12x1.0	17	24	19	31.0	21.0	27.0	11.0	20.5	12.0	7.0	12.000
SOL 52824-10-1/4	078.2841.270	330	14x1.0	19	24	19	33.0	21.0	27.0	11.0	20.5	12.0	7.0	13.190
SOL 52824-12-3/8	078.2841.390	330	16x1.0	22	30	24	36.5	28.0	35.0	12.0	24.0	15.0	9.0	24.600
SOL 52824-15-1/2	078.2841.534	250	20x1.5	27	35	27	43.0	32.0	41.5	13.0	28.0	18.0	12.0	39.100
SOL 52824-16-1/2	078.2841.566	200	24x1.5	30	35	27	46.0	32.0	43.5	11.0	28.5	18.0	12.0	42.400
SOL 52824-18-1/2	078.2841.646	200	24x1.5	30	35	27	45.0	32.0	43.5	11.0	28.5	18.0	12.0	41.700
Für Zollrohre														
SOL 52824-6,35-1/8	078.2841.135	400	10x1.0	14	16	14	29.0	18.0	21.0	10.0	18.0	10.5	4.5	2.200
SOL 52824-9,52-1/4	078.2841.230	330	14x1.0	19	24	19	33.5	21.0	27.0	9.0	20.5	12.0	7.0	4.600
SOL 52824-12,7-1/2	078.2841.434	330	20x1.5	27	35	27	43.5	32.0	41.5	13.5	28.5	18.0	11.0	25.600

Umrechnung für "d" bei Zollrohren:

6,35 = 1/4

9,52 = 3/8

12,7 = 1/2

Conversion de "d" pour tubes en pouces:

6,35 = 1/4

9,52 = 3/8

12,7 = 1/2

Conversion for "d" for inch tubes:

6,35 = 1/4

9,52 = 3/8

12,7 = 1/2

O-Ringe: FKM

Joints: FKM

O-Rings: FKM

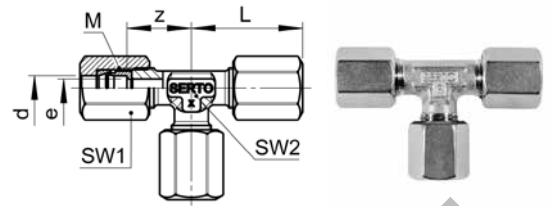
T-Verschraubung
Té égal
Tee union

SOL 53021

Type-d	Mat.-Nr.	bar	M	SW1	SW2	L	z	e	kg/100
Für metrische Rohre	Pour tubes métriques			For metric tubes					
SOL 53021-6	078.3000.060	400	10x1.0	14	9	26.0	16.0	4.5	6.500
SOL 53021-8	078.3000.080	330	12x1.0	17	10	28.5	18.0	6.5	9.600
SOL 53021-10	078.3000.100	330	14x1.0	19	12	33.5	20.5	8.5	12.900
SOL 53021-12	078.3000.120	330	16x1.0	22	14	35.0	21.5	9.5	17.800
SOL 53021-15	078.3000.150	250	20x1.5	27	17	39.0	24.0	13.0	29.600
SOL 53021-16	078.3000.160	200	24x1.5	30	22	45.0	26.0	14.0	40.800
SOL 53021-18	078.3000.180	200	24x1.5	30	22	43.5	26.5	15.0	38.100
Für Zollrohre	Pour tubes pouces			For inch tubes					
SOL 53021-6,35	078.3000.063	400	10x1.0	14	9	25.5	16.5	4.5	6.800
SOL 53021-9,52	078.3000.095	330	14x1.0	19	12	33.5	21.0	8.0	13.900
SOL 53021-12,7	078.3000.127	330	20x1.5	27	17	39.5	24.5	11.0	32.400

Umrechnung für "d" bei Zollrohren:

6,35 = 1/4

9,52 = 3/8

12,7 = 1/2

Conversion de "d" pour tubes en pouces:

6,35 = 1/4

9,52 = 3/8

12,7 = 1/2

Conversion for "d" for inch tubes:

6,35 = 1/4

9,52 = 3/8

12,7 = 1/2

Einstellbare T-Verschraubung

Té orientable au centre

Adjustable Tee union

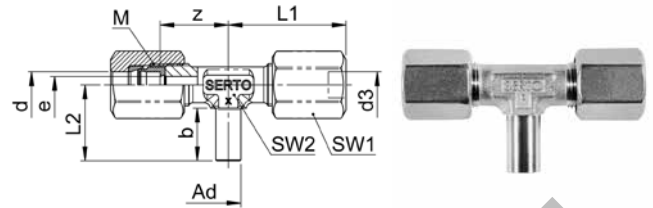

SOL 53621 T

Type -d -Ad -d3	Mat.-Nr.	bar	M	SW1	SW2	L1	L2	b	z	e	kg/100
Für metrische Rohre	Pour tubes métriques			For metric tubes							
SOL 53621-6-A6-6	078.3600.060	400	10x1.0	14	9	26.0	18.0	12.5	16.0	4.0	4.750
SOL 53621-8-A8-8	078.3600.080	330	12x1.0	17	10	28.5	23.0	15.0	18.0	6.0	6.920
SOL 53621-10-A10-10	078.3600.100	330	14x1.0	19	12	33.0	25.5	17.0	20.5	7.0	9.400
Für Zollrohre	Pour tubes pouces			For inch tubes							
SOL 53621-6,35-A6-6,35	078.3600.067	400	10x1.0	14	9	27.0	18.0	12.5	16.5	4.0	4.900
SOL 53621-9,52-A10-9,52	078.3600.095	330	14x1.0	19	12	33.5	25.5	17.0	21.0	7.0	10.300

Umrechnung für "d" bei Zollrohren:
 6,35 = 1/4
 9,52 = 3/8

Conversion de "d" pour tubes en pouces:
 6,35 = 1/4
 9,52 = 3/8

Conversion for "d" for inch tubes:
 6,35 = 1/4
 9,52 = 3/8

Anwendungsbeispiele:

Exemples d'utilisation:

Sample combinations:

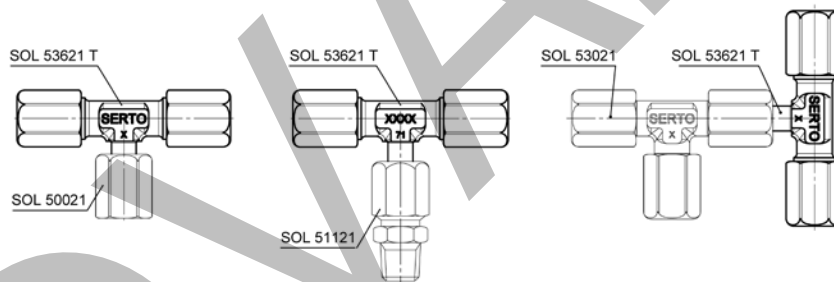

Mögliche Kombinationen:

- mit Armaturenanschluss zu einstellbaren T-Verschraubungen
- mit Verschraubungen zu einstellbaren Verschraubungen
- mit Einschraubverschraubungen zu einstellbaren T-Einschraubverschraubungen. Gegenüber der T-Einschraubverschraubung lässt sich diese Kombination einfacher einstellen, da Einschrauben und Ausrichten getrennt voneinander vorgenommen werden.

Combinaisons possibles:

- avec écrou de raccordement ça donne un Té orientable
- avec raccords ça donne des raccords orientables
- avec une union mâle ça donne un Té fileté orientable. Par rapport au Té orientable, cette combinaison est facile à régler, puisque le vissage et l'alignement sont réalisés séparément l'un de l'autre.

Possible combinations:

- with nut connections to adjustable tee unions
- with unions to adjustable unions
- with male adaptor unions to adjustable male adaptor tee unions. This combination is simpler to produce, as screwing in and alignment are carried out separately.

d=Rohrassens-ø
 Ad=Aussen-ø der Andrehung
 e=kleinste Bohrung
 L=Mass in montiertem Zustand

d=ø extérieur du tube
 Ad=ø extérieur de la portée cylindrique
 e=ø-min. de passage
 L=après montage

d=tube outside diameter
 Ad=outside diameter of cyl. stub
 e=minimum bore
 L=installed length

Einstellbare L-Verschraubung

Té orientable en bout

Adjustable L union

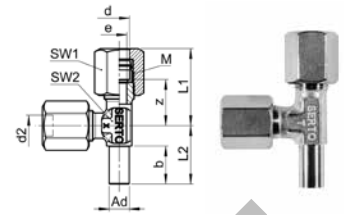

SOL 53621 L

Type -d -d2 -Ad	Mat.-Nr.	bar	M	SW1	SW2	L1	L2	b	z	e	kg/100
SOL 53621-6-6-A6	078.3610.060	400	10x1.0	14	9	26.0	18.0	12.5	16.0	4.0	4.750
SOL 53621-8-8-A8	078.3610.080	330	12x1.0	17	10	28.5	23.0	15.0	18.0	6.0	6.920
SOL 53621-10-10-A10	078.3610.100	330	14x1.0	19	12	33.0	25.5	17.0	20.5	7.0	9.400

Anwendungsbeispiele:

Exemples d'utilisation:

Sample combinations:

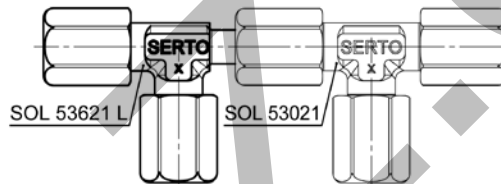
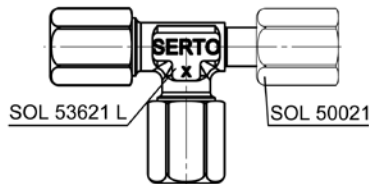

Mögliche Kombinationen:

- mit Armaturenanschluss zu einstellbaren L-Verschraubungen
- mit Verschraubungen zu einstellbaren Verschraubungen
- mit Einschraubverschraubungen zu einstellbaren L-Einschraubverschraubungen. Gegenüber der L-Einschraubverschraubung lässt sich diese Kombination einfacher einstellen, da Einschrauben und Ausrichten getrennt voneinander vorgenommen werden.

Combinaisons possibles:

- avec écrou de raccordement ça donne un L orientable
- avec raccords ça donne des raccords orientables
- avec une union mâle ça donne un L fileté orientable. Par rapport au L orientable, cette combinaison est facile à régler, puisque le vissage et l'alignement sont réalisés séparément l'un de l'autre.

Possible combinations:

- with nut connections to adjustable L unions
- with unions to adjustable unions
- with male adaptor unions to adjustable male adaptor L unions. This combination is simpler to produce, as screwing in and alignment are carried out separately.

Einstellbare T-Verschraubung vormontiert

Té orientable au centre prémonté

Adjustable tee union pre-assembled

SOL 53625 T

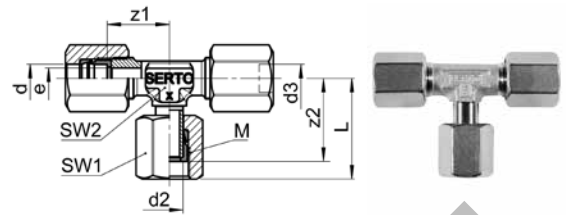

Type -d -d2 -d3	Mat.-Nr.	bar	M	SW1	SW2	L	z1	z2	e	kg/100
SOL 53625-6-A6-6	078.3620.060	400	10x1.0	14	9	26.0	16.0	19.0	4.0	6.400
SOL 53625-8-A8-8	078.3620.080	330	12x1.0	17	10	28.5	18.0	24.0	6.0	9.420
SOL 53625-10-A10-10	078.3620.100	330	14x1.0	19	12	33.0	20.5	26.5	7.0	12.670

Einstellbare L-Verschraubung vormontiert

Té orientable en bout prémonté

Adjustable L union pre-assembled

SOL 53625 L

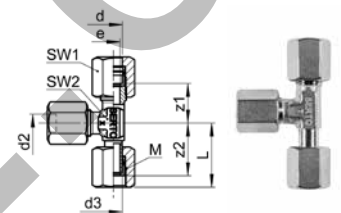

Type -d -d2 -d3	Mat.-Nr.	bar	M	SW1	SW2	L	z1	z2	e	kg/100
SOL 53625-6-6-A6	078.3630.060	400	10x1.0	14	9	26.0	16.0	19.0	4.0	6.400
SOL 53625-8-8-A8	078.3630.080	330	12x1.0	17	10	28.5	18.0	24.0	6.0	9.420
SOL 53625-10-10-A10	078.3630.100	330	14x1.0	19	12	33.0	20.5	26.5	7.0	12.670

Montagehinweis: Anschlussmutter auf Seite Einstellteil mit 1/4 Umdrehung anziehen.
Wir empfehlen eine zusätzliche Schmierung auf der Planfläche.

Note d'installation: Serrez l'écrou du côté orientable de 1/4 de tour.
Nous recommandons une lubrification supplémentaire sur la surface plane.

Assembly information: Tighten the union nut on the adjustable side with 1/4 turn.
We recommend additional lubrication on the plane surface.

Kreuzverschraubung

Croix égale

Cross union

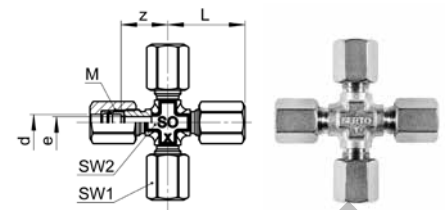

SOL 54021

Type -d	Mat.-Nr.	bar	M	SW1	SW2	L	z	e	kg/100
Für metrische Rohre	Pour tubes métriques			For metric tubes					
SOL 54021-6	078.4000.060	400	10x1.0	14	12	27.5	17.5	4.5	8.900
SOL 54021-8	078.4000.080	330	12x1.0	17	12	29.5	19.0	6.5	13.200
SOL 54021-10	078.4000.100	330	14x1.0	19	14	35.5	23.0	8.5	17.300
SOL 54021-12	078.4000.120	330	16x1.0	22	14	38.5	25.0	9.5	23.400
SOL 54021-15	078.4000.150	250	20x1.5	27	17	41.0	26.0	13.0	39.100

Für Zollrohre	Pour tubes pouces			For inch tubes					
SOL 54021-6,35	078.4000.063	400	10x1.0	14	12	27.0	17.5	4.5	9.700
SOL 54021-9,52	078.4000.095	330	14x1.0	19	14	36.0	23.5	8.0	10.000
SOL 54021-12,7	078.4000.127	330	20x1.5	27	17	41.5	26.5	11.0	19.200

Umrechnung für "d" bei Zollrohren:

6,35 = 1/4
 9,52 = 3/8
 12,7 = 1/2

Conversion de "d" pour tubes en pouces:

6,35 = 1/4
 9,52 = 3/8
 12,7 = 1/2

Conversion for "d" for inch tubes:

6,35 = 1/4
 9,52 = 3/8
 12,7 = 1/2

**HKM-G**

Hochdruck-Kugelhähne beidseitig
Innengewinde nach ISO 228/1
Vannes à bille pour haute pression avec taraudage BSP selon DIN-ISO 228/1
High pressure ball valves double-sided female thread to ISO 228/1

547**SOL BV 58A21**

Hochdruck-Kugelhahn SOL
Vanne à bille SOL haute pression
High pressure ball valve SOL

547**SOL CV 53B21**

Kegelrückschlagventil
Clapet anti-retour à siège conique
Taper seat non-return valve

548

Aluminium

Verschraubungen









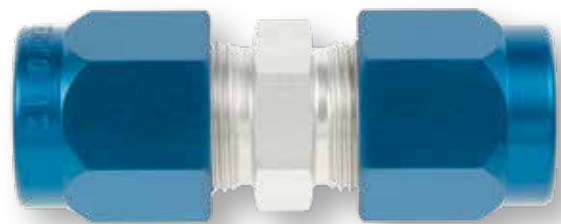











Aluminium

Raccords

Aluminium

Unions



Seite/Page/Page		Seite/Page/Page		Seite/Page/Page	
336	<p>Klemmring Bague de serrage Compression ferrule</p>  <p>SO 10001</p>	342-343	<p>Gerade Einschraubverschraubung Union mâle Male adaptor union</p>  <p>SO 11124 OR</p>	350	<p>Kreuzverschraubung Croix égale Cross union</p>  <p>SO 14021</p>
336	<p>Abschlusszapfen Bouchon d'arrêt Plug</p>  <p>SO 10002</p>	344-345	<p>Einstellbare Einschraubverschraubung Union mâle orientable Adjustable male adaptor union</p>  <p>SO 11335 OR</p>	<p>Bestätigungen auf www.serto.com Confirmations sur www.serto.com Confirmations on www.serto.com</p> <p>    </p>	
337	<p>Stützhülse Douille d'appui Stiffener sleeve</p>  <p>SO 10003</p>	346	<p>Einstellbare Verschraubung Union orientable Adjustable union</p>  <p>SO 11345 OR</p>		
338	<p>Sechskantmutter Ecroû à six pans Hexagon nut</p>  <p>SO 10006 METR</p>	347	<p>Gerade Schottverschraubung Union double traversée de cloison Panel mount union</p>  <p>SO 11524</p>		
339	<p>Anschlussmutter Ecroû Union nut</p>  <p>SO 10020</p>	348	<p>Winkelverschraubung Coude Elbow union</p>  <p>SO 12021</p>		
339	<p>Armaturenanschluss Ecroû et bague de raccordement Nut connection</p>  <p>SO 10021</p>	348	<p>Winkel-Schottverschraubung Coude traversée de cloison Panel mount elbow union</p>  <p>SO 12721</p>		
340	<p>Anschlussnippel METR Ecroû de raccordement mâle METR Nipple connection METR</p>  <p>SO 11001</p>	349	<p>Schwenkverschraubung Coude banjo Single banjo</p>  <p>SO 12824</p>		
341	<p>Gerade Verschraubung Union double Straight union</p>  <p>SO 11021</p>	350	<p>T-Verschraubung Té égal Tee union</p>  <p>SO 13021</p>		

Aluminium

Eigenschaften, Besonderheiten

- sehr leicht – nur rund ein Drittel des Gewichts von Edelstahl oder Messing
- einfache, schnelle Montage
- kompakte Baumasse
- gute Korrosions- und Witterungsbeständigkeit
- initialgeschmiert und damit montagebereit

Funktionsprinzip

Siehe Kapitel i

Werkstoff

Aluminium EN AW-6082, 3.2315

- Anschlussmutter/-nippel: blau eloxiert
- Klemmring: beschichtet
- Grundteil: farblos eloxiert

Betriebsdruck PN

Siehe Produkttabellen (4-fache Sicherheit)

Temperaturbereich

-196°C bis +120°C

Helium-Leckrate

10⁻⁶ mbar • l/s *

Vakuum

Bis 10⁻⁴ mbar, höhere Werte möglich

Anzuschliessende Rohre

Gezogene Rohre mit Durchmesser-toleranzen nach DIN EN 754-7 (nahtlos gezogen), resp. 754-8 (nicht nahtlos gezogen). Es können auch gepresste (nicht gezogene) Rohre eingesetzt werden. Der Aussendurchmesser muss jedoch im Toleranzband von DIN EN 754 liegen.

Für Kunststoffrohre Aluminium-Stützhülse (SO 10003) einsetzen.

Einschraubzapfen, Gewinde

Rohrgewinde (Zoll) und metrisches Feingewinde DIN 3852, mit Dichtkante nach Form B.

Druckauswertungsgrad in % des PN



* bei fachgerechter Montage; siehe Kapitel i:
- Montageanleitung
- Rohempfehlungen

Aluminium

Propriétés, spécificités

- très légère – près d'un tiers du poids de l'acier inoxydable ou du laiton
- montage facile et rapide
- dimensions compactes
- bonne résistance à la corrosion et aux intempéries
- pré-lubrifiée et donc prête au montage

Principe de fonctionnement

Voir chapitre i

Matériau

Aluminium EN AW-6082, 3.2315

- écrou/écrou de raccord. mâle : anodisé bleu
- bague de serrage: revêtue
- corps: anodisé incolore

Pression de service PN

Voir tableaux des produits (facteur de sécurité 4)

Plage de température admissible

-196°C à +120°C

Débit de fuite avec hélium

10⁻⁶ mbar • l/s *

Vide

Jusqu'à 10⁻⁴ mbar, valeurs plus élevées possible

Tubes à utiliser

Des tubes étirés avec des tolérances de diamètre conformes à DIN EN 754-7 (étirés sans soudure) ou 754-8 (non étirés sans soudure). Des tubes comprimés (non étirés) peuvent également être employés. Le diamètre extérieur doit néanmoins être compris dans la plage de tolérance de DIN EN 754.

Pour les tubes en plastique, utiliser la douille d'appui en aluminium (SO 10003).

Embouts mâles, filetages

Filetage-gaz (BSP) et filetage métrique à pas fin DIN 3852; filetage d'étanchéité selon forme B.

Coefficient de pression de service admissible en % de PN

Aluminium

Characteristics, specialities

- very light – almost one third of the weight of stainless steel or brass
- easy and fast to install
- compact size
- good resistance to corrosion and weathering
- initially lubricated, therefore ready for installation

Operating principle

See chapter i

Material

Aluminium EN AW-6082, 3.2315

- union nut/nipple connection: blue anodised
- compression ferrule: coated
- union body: colourless anodised

Working pressure PN

See product tables (safety factor 4)

Temperature range

-196°C to +120°C

Leak rate with helium

10⁻⁶ mbar • l/s *

Vacuum

Up to 10⁻⁴ mbar, higher values are possible

Tubes to use

Drawn tubes with diameter tolerances according to DIN EN 754-7 (seamless drawn tubes), or 754-8 (not seamlessly drawn). Pressed (not drawn) tubes may also be used. However the external diameter must be within the tolerance range of DIN EN 754.

For plastic tubes use Aluminium stiffener sleeve(SO 10003).

Adaptor stem, male thread

British Standard Pipe (BSP) and metric fine thread DIN 3852; thread with edge seal form B.

Pressure coefficient % of PN

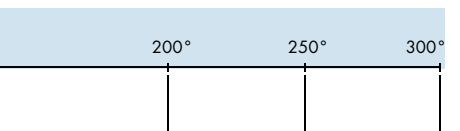

* when professionally assembled; see chapter i:
- Installation instructions
- Recommendations for tubes

Klemmring

Bague de serrage

Compression ferrule

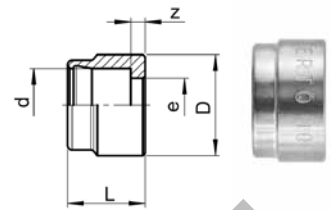

SO 10001

Type-d	Mat.-Nr.	bar	L	D	z	e	kg/100
SO 10001-8	116.0010.080	100	7.0	10.5	1.0	6.0	0.060
SO 10001-10	116.0010.100	100	7.5	12.7	1.0	8.0	0.080
SO 10001-12	116.0010.120	100	8.5	14.7	1.0	9.0	0.120
SO 10001-15	116.0010.150	100	10.0	18.0	1.5	12.0	0.190
SO 10001-18	116.0010.180	100	10.0	22.0	1.5	15.0	0.310
SO 10001-22 OR	116.0009.220	64	11.0	25.7	1.5	18.0	0.390
SO 10001-28 OR	116.0009.280	64	13.0	32.7	2.0	24.0	0.720
SO 10001-35 OR	116.0009.350	40	13.0	39.0	2.0	30.0	0.780

Abschlusszapfen

Bouchon d'arrêt

Plug

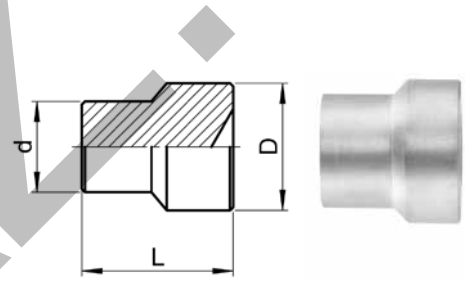

SO 10002

Type-d	Mat.-Nr.	L	D	kg/100
SO 10002-8	116.0020.080	10.5	10.5	0.190
SO 10002-10	116.0020.100	12.0	12.7	0.310
SO 10002-12	116.0020.120	14.0	14.7	0.510
SO 10002-15	116.0020.150	15.0	18.0	0.830
SO 10002-18	116.0020.180	16.8	22.0	1.310
SO 10002-22	116.0020.220	19.0	25.7	2.090
SO 10002-28	116.0020.280	22.5	32.7	4.030
SO 10002-35	116.0020.350	19.0	39.0	4.900

Anwendungsbeispiele:

Der Abschlusszapfen lässt sich in jede Verschraubung anstelle eines Klemmringes der gleichen Größe einsetzen.

Montagehinweis: Anschlussmutter mit 1/4 Umdrehung anziehen.

Exemples d'utilisation:

Le bouchon d'arrêt s'insère dans tout raccord au lieu d'une bague de serrage de la même taille.

Note d'installation: Serrez l'écrou d'accouplement de 1/4 de tour.

Sample combinations:

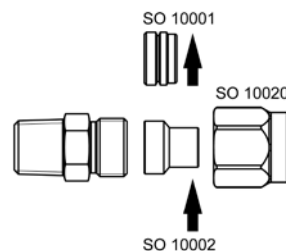

The plug can be inserted into all unions instead of a compression ferrule of the same size.

Assembly information: Tighten the union nut with 1/4 turn.

Stützhülse

zur Rohrverstärkung

Douille d'appui

pour renforcer les tubes

Stiffener sleeve

to reinforce tubes

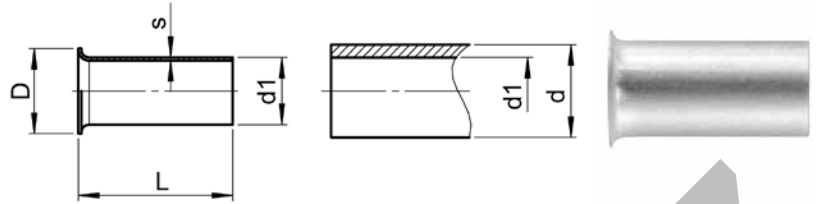

SO 10003

Type -d-d1	Mat.-Nr.	L	D	s	kg/100
SO 10003-8-6	116.0030.140	12.0	7.5	0.25	0.020
SO 10003-10-7	116.0030.180	15.0	9.5	0.30	0.030
SO 10003-10-8	116.0030.190	16.0	9.5	0.30	0.030
SO 10003-12-9	116.0030.230	20.0	11.5	0.40	0.060
SO 10003-12-10	116.0030.240	20.0	11.5	0.40	0.060
SO 10003-15-12	116.0030.420	24.0	14.5	0.50	0.120
SO 10003-18-15	116.0030.610	26.0	16.5	0.60	0.190
SO 10003-18-16	116.0030.620	26.0	17.5	0.60	0.200

Werkstoff: Aluminium AW 6060

Matériau: Aluminium AW 6060

Material: Aluminium AW 6060

Für die Verwendung von Aluminium-Verschraubungen in Kombination mit Kunststoff-Rohren.

Pour l'usage des raccords en aluminium en combinaison avec des tubes en plastique.

For the use of aluminium unions in combination with plastic tubes.

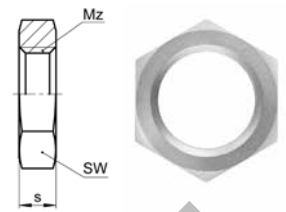
Sechskantmutter METR
Ecrou à six pans METR
Hexagon nut METR

SO 10006 METR

Type -Mz	Mat.-Nr.	SW	s	kg/100
Mz=metrisches Gewinde (zylindrisch)	Mz=Filetage métrique (cylindrique)	Mz=Metric thread (parallel)		
SO 10006-M14x1	116.0063.220	19	7.00	0.330
SO 10006-M16x1	116.0063.260	22	7.00	0.450
SO 10006-M24x1,5	116.0063.405	30	12.00	1.200
SO 10006-M28x1,5	116.0063.445	36	14.00	2.100

Sechskantmutter für SO 11524, SO 12721

Ecrou à six pans pour SO 11524, SO 12721

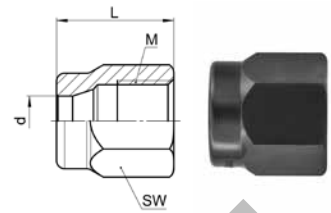
Hexagon nut for SO 11524, SO 12721

Anschlussmutter
Ecrou
Union nut

SO 10020

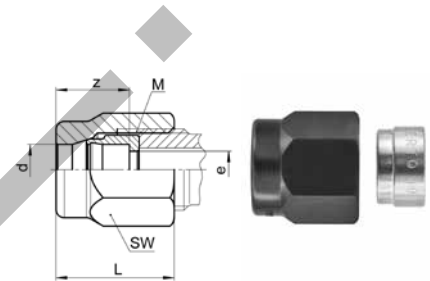
Type-d	Mat.-Nr.	bar	M	SW	L	kg/100
SO 10020-8	116.0200.080	100	12x1.0	14	16.0	0.340
SO 10020-10	116.0200.100	100	14x1.0	17	18.5	0.620
SO 10020-12	116.0200.120	100	16x1.0	19	20.0	0.770
SO 10020-15	116.0200.150	100	20x1.5	24	24.0	1.530
SO 10020-18	116.0200.180	100	24x1.5	30	25.0	2.640
SO 10020-22	116.0200.220	64	28x1.5	32	28.0	2.710
SO 10020-28	116.0200.280	64	36x2.0	41	32.0	4.970
SO 10020-35	116.0200.350	40	42x2.0	50	32.0	7.880

Armaturenanschluss
Ecrou et bague de raccordement
Nut connection

SO 10021

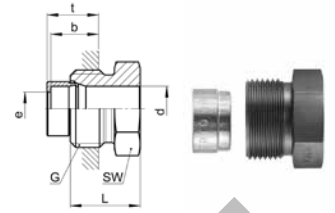
Type-d	Mat.-Nr.	bar	M	SW	L	z	e	kg/100
SO 10021-8	116.0210.080	100	12x1.0	14	16.0	8.5	6.0	0.400
SO 10021-10	116.0210.100	100	14x1.0	17	18.5	10.5	8.0	0.700
SO 10021-12	116.0210.120	100	16x1.0	19	20.0	12.0	9.0	0.890
SO 10021-15	116.0210.150	100	20x1.5	24	24.0	13.0	12.0	1.720
SO 10021-18	116.0210.180	100	24x1.5	30	25.0	13.5	15.0	2.960
SO 10021-22	116.0210.220	64	28x1.5	32	28.0	16.5	18.0	3.100
SO 10021-28	116.0210.280	64	36x2.0	41	32.0	16.5	24.0	5.690
SO 10021-35	116.0210.350	40	42x2.0	50	32.0	17.0	30.0	8.660

Anschlussnippel
Ecrou de raccordement mâle
Nipple connection



SO 11001

Type -d-G	Mat.-Nr.	bar	SW	L	b	t	e	kg/100
G=Rohrgewinde (zylindrisch)	G=Filetage-gaz BSP (cylindrique)	G=BSP thread (parallel)						
SO 11001-8-1/4	118.0905.170	100	14	15.0	9.0	10.0	6.0	0.400
SO 11001-10-3/8	118.0905.280	100	17	15.0	9.0	10.0	8.0	0.620

Anschlussnippel METR
Ecrou de raccordement mâle METR
Nipple connection METR

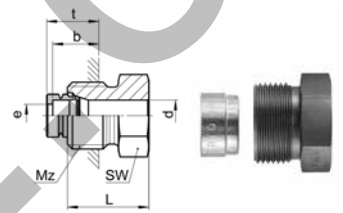

SO 11001 METR

Type -d-Mz	Mat.-Nr.	bar	SW	L	b	t	e	kg/100
Mz=metrisches Gewinde (zylindrisch)	Mz=Filetage métrique (cylindrique)	Mz=Metric thread (parallel)						
SO 11001-10-M16x1	118.0901.284	100	17	15.0	9.0	10.0	8.0	0.600
SO 11001-12-M18x1	118.0901.332	100	19	15.0	10.0	11.0	9.0	0.700

Anwendungsbeispiele:

Exemples d'utilisation:

Sample combinations:

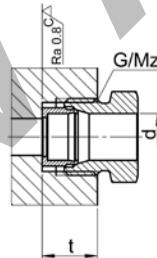

Gerade Verschraubung
Union double
Straight union

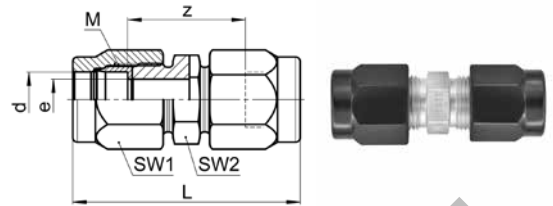

SO 11021

Type-d	Mat.-Nr.	bar	M	SW1	SW2	L	z	e	kg/100
SO 11021-8	118.1020.080	100	12x1.0	14	12	41.0	24.5	6.0	1.280
SO 11021-10	118.1020.100	100	14x1.0	17	14	47.0	25.5	8.0	2.000
SO 11021-12	118.1020.120	100	16x1.0	19	17	50.0	26.0	9.0	2.680
SO 11021-18	118.1020.180	100	24x1.5	30	24	64.0	37.0	15.0	8.310
SO 11021-22	118.1020.220	64	28x1.5	32	30	71.0	38.0	18.0	9.700
SO 11021-28	118.1020.280	64	36x2.0	41	36	82.0	49.0	24.0	17.900
SO 11021-35	118.1020.350	40	42x2.0	50	46	85.0	51.0	30.0	26.600

Gerade Verschraubung reduziert
Union double réduite
Straight reduction union

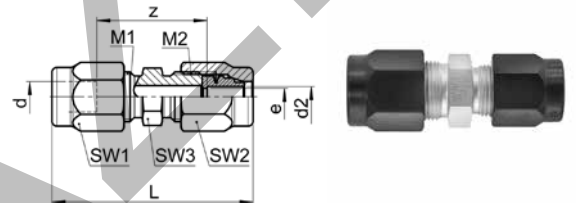

SO 11021 RED

Type-d-d2	Mat.-Nr.	bar	M1	M2	SW1	SW2	SW3	L	z	e	kg/100
SO 11021-12-10	118.1024.240	100	16x1.0	14x1.0	19	17	17	49.0	26.0	8.0	2.500

d=Rohrassen-ø
 e=kleinste Bohrung
 L=Mass in montiertem Zustand

d=ø extérieur du tube
 e=ø-min. de passage
 L=après montage

d=tube outside diameter
 e=minimum bore
 L=installed length

Gerade Einschraubverschraubung

mit Conovor O-Ringabdichtung (FKM)

Union mâle

avec joint torique système Conovor (FKM)

Male adaptor union

with Conovor O-ring seal (FKM)

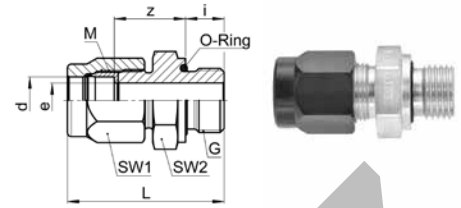

SO 11124 OR

Type -d-G	Mat.-Nr.	bar	M	SW1	SW2	L	D	i	t	O-Ring	z	e	kg/100
G=Rohrgewinde (zylindrisch)	G=Filetage-gaz BSP (cylindrique)	G=BSP thread (parallel)											
SO 11124-8-1/4 OR	118.1171.170	100	12x1.0	14	19	35.5	19.0	10.0	1.5	11.1x1.78	17.0	6.0	1.310
SO 11124-10-1/4 OR	118.1171.270	100	14x1.0	17	19	39.0	19.0	10.0	1.5	11.1x1.78	18.0	8.0	1.600
SO 11124-10-1/2 OR	118.1171.285	100	14x1.0	17	27	43.5	27.0	12.0	2.5	18.72x2.62	21.0	8.0	3.000
SO 11124-10-1 OR	118.1171.300	100	14x1.0	17	41	47.5	42.0	14.0	2.5	27.8x3.6	23.0	8.0	6.200
SO 11124-12-1/4 OR	118.1171.380	100	16x1.0	19	19	40.0	19.0	10.0	1.5	11.1x1.78	18.0	8.0	1.900
SO 11124-12-3/8 OR	118.1171.390	100	16x1.0	19	22	40.5	23.0	10.0	2.0	14.0x1.78	18.5	9.0	2.320
SO 11124-12-1/2 OR	118.1171.400	100	16x1.0	19	27	45.0	27.0	12.0	2.5	18.72x2.62	21.0	9.0	3.200
SO 11124-15-1/2 OR	118.1171.534	100	20x1.5	24	27	50.0	27.0	12.0	2.5	18.72x2.62	25.5	12.0	4.400
SO 11124-15-3/4 OR	118.1171.536	100	20x1.5	24	32	51.0	33.0	12.0	2.5	23.47x2.62	26.5	12.0	6.000
SO 11124-18-1/2 OR	118.1171.646	100	24x1.5	30	27	51.0	27.0	12.0	2.5	18.72x2.62	25.5	13.0	5.700
SO 11124-18-3/4 OR	118.1171.648	100	24x1.5	30	32	54.0	33.0	12.0	2.5	23.47x2.62	28.5	15.0	7.380
SO 11124-22-3/4 OR	118.1171.768	64	28x1.5	32	32	55.0	33.0	12.0	2.5	23.47x2.62	26.5	18.0	7.000
SO 11124-28-1 OR	118.1171.850	64	36x2.0	41	41	63.0	42.0	14.0	2.5	27.8x3.6	32.5	24.0	12.450
SO 11124-35-1 1/4 OR	118.1171.944	40	42x2.0	50	50	70.5	52.0	16.0	2.5	37.69x3.53	37.5	30.0	20.800

Gerade Einschraubverschraubung METR

mit Conovor O-Ringabdichtung (FKM)

Union mâle METR

avec joint torique système Conovor (FKM)

Male adaptor union METR

with Conovor O-ring seal (FKM)

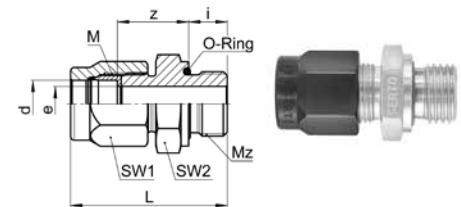

SO 11124 OR METR

Type -d-Mz	Mat.-Nr.	bar	M	SW1	SW2	L	D	i	t	O-Ring	z	e	kg/100
Mz=metrisches Gewinde (zylindrisch)	Mz=Filetage métrique (cylindrique)	Mz=Metric thread (parallel)											
SO 11124-10-M14x1.5 OR	118.1173.280	100	14x1.0	17	19	38.0	19.5	10.0	1.5	11.1x1.78	17.0	8.0	1.600
SO 11124-12-M12x1.5 OR	118.1173.320	100	16x1.0	19	17	39.0	17.5	10.0	1.5	9.25x1.78	17.0	6.0	1.700
SO 11124-15-M18x1.5 OR	118.1173.390	100	20x1.5	24	22	47.0	23.5	10.0	2.0	15.6x1.78	24.0	12.0	3.400

Fortsetzung nächste Seite

Suite à la prochaine page

Continued on next page

Einbauempfehlung:

Conseil de montage:

Recommendation for installation:

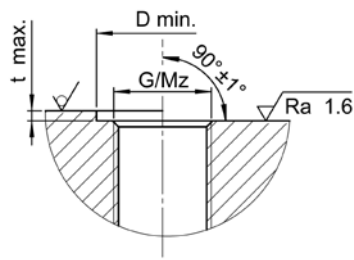

Einsatztemperaturbereich: -20 °C bis +120 °C

Die Vorteile dieser O-Ringabdichtung:

- keine Dichtmittelreste in Geräten
- einwandfreie Abdichtung
- keine Beschädigung von Geräten durch konische Gewinde
- schnelle Montage

Conovor patentierte O-Ring Abdichtung

Plage de température de service: -20 °C à +120 °C

Les avantages de cette étanchéité à joint torique:

- aucun reste de scellant dans les équipements
- une étanchéité parfaite
- aucun endommagement de l'équipement par le filetage conique
- facilité d'installation

Etanchéité à joint torique brevetée Conovor

Operating temperature range: -20 °C to +120 °C

Advantages of this O-ring seal:

- no sealing residues in devices
- perfect seal
- no damage to devices due to tapered thread
- rapid assembly

Conovor patented O-ring seal

KONOVAN

d=Rohrassen-ø
e=kleinste Bohrung
L=Mass in montiertem Zustand

d=ø extérieur du tube
e=ø-min. de passage
L=après montage

d=tube outside diameter
e=minimum bore
L=installed length

Einstellbare Einschraubverschraubung

mit Conovor O-Ringabdichtung (FKM)

Union mâle orientable

avec joint torique système Conovor (FKM)

Adjustable male adaptor union

with Conovor O-ring seal (FKM)

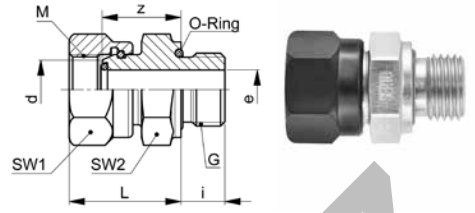

SO 1135 OR

Type -d-G	Mat.-Nr.	bar	M	SW1	SW2	L	D	i	t	O-Ring	z	e	kg/100
G=Rohrgewinde (zylindrisch)													
G=Filetage-gaz BSP (cylindrique)													
G=BSP thread (parallel)													
SO 11335-8-1/4 OR	118.1651.170	100	12x1.0	17	19	21.5	19.0	10.0	1.5	11.1x1.78	15.0	6.0	1.400
SO 11335-10-1/4 OR	118.1651.270	100	14x1.0	19	19	24.5	19.0	10.0	1.5	11.1x1.78	17.0	8.0	1.500
SO 11335-12-3/8 OR	118.1651.390	100	16x1.0	22	22	25.5	23.0	10.0	2.0	14.0x1.78	18.0	9.0	2.300
SO 11335-15-1/2 OR	118.1651.534	100	20x1.5	27	27	31.5	27.0	12.0	2.5	17.12x2.62	22.0	12.0	4.100
SO 11335-18-3/4 OR	118.1651.648	100	24x1.5	32	32	32.5	33.0	12.0	2.5	23.47x2.62	23.0	15.0	6.100
SO 11335-22-3/4 OR	118.1651.768	64	28x1.5	36	32	32.5	33.0	12.0	2.5	23.47x2.62	23.0	18.0	6.100
SO 11335-35-1 1/4 OR	118.1651.944	40	42x2.0	55	50	43.5	52.0	16.0	2.5	37.69x3.53	31.0	30.0	18.400

Anwendungsbeispiele:

Exemples d'utilisation:

Sample combinations:

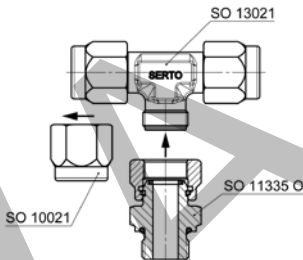

Mit der einstellbaren Einschraubverschraubung lassen sich verschiedene Grundteile einfach verbinden. Kompakte Bauweise, schnelle Montage, einfache Fixierung der Komponenten in der gewünschten Stellung.

d = Kenngröße: entspricht dem Rohraussen-ø des Armaturenanschlusses SO 10021, der gegen die einstellbare Einschraubverschraubung SO 11335 OR ausgetauscht werden kann.

Montagehinweis: Anschlussmutter mit 1/8 Umdrehung anziehen. Wir empfehlen eine zusätzliche Schmierung auf der Planfläche.

L'union orientable mâle permet de connecter facilement différents corps de raccord. Construction compacte, montage rapide, fixation facile des composants dans la position désirée.

d = dimension nominale: correspond au dia. extérieur du tube de l'écrou et bague de raccordement SO 10021, lequel peut être échangé contre l'union mâle orientable SO 11335 OR.

Note d'installation: Serrez l'écrou de 1/8 de tour. Nous recommandons une lubrification supplémentaire sur la surface plane.

With the adjustable male adaptor union different basic components can easily be connected. Compact construction, quick assembly, and easy fixing of the components in the desired position.

d = nominal size: corresponds to tube outside diameter of the nut connection SO 10021 which can be replaced by the adjustable male adaptor union SO 11335 OR.

Assembly information: Tighten the union nut with 1/8 turn. We recommend additional lubrication on the plane surface.

Fortsetzung nächste Seite

Suite à la prochaine page

Continued on next page

Einbauempfehlung:

Conseil de montage:

Recommendation for installation:

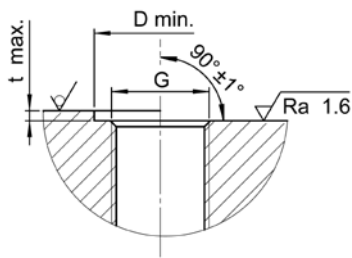

Einsatztemperaturbereich: -20 °C bis +120 °C

Plage de température de service: -20 °C à +120 °C

Operating temperature range: -20 °C to +120 °C

Die Vorteile dieser O-Ringabdichtung:

- keine Dichtmittelreste in Geräten
- einwandfreie Abdichtung
- keine Beschädigung von Geräten durch konische Gewinde
- schnelle Montage

Les avantages de cette étanchéité à joint torique:

- aucun reste de scellant dans les équipements
- une étanchéité parfaite
- aucun endommagement de l'équipement par le filetage conique
- facilité d'installation

Advantages of this O-ring seal:

- no sealing residues in devices
- perfect seal
- no damage to devices due to tapered thread
- rapid assembly

Conovor patentierte O-Ring Abdichtung

Etanchéité à joint torique brevetée Conovor

Conovor patented O-ring seal

KONOVOR

Einstellbare Verschraubung

mit O-Ringabdichtung (FKM)

Union orientable

avec joint torique (FKM)

Adjustable union

with O-ring seal (FKM)

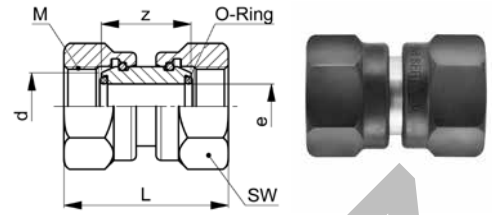

SO 11345 OR

Type -d	Mat.-Nr.	bar	M	SW	L	O-Ring	z	e	kg/100
SO 11345-8 OR	118.1350.080	100	12x1.0	17	29.0	6.0x1.0	16.0	6.0	1.200
SO 11345-10 OR	118.1350.100	100	14x1.0	19	33.0	8.0x1.0	18.0	8.0	1.600
SO 11345-12 OR	118.1350.120	100	16x1.0	22	33.0	9.0x1.5	18.0	9.0	2.200
SO 11345-15 OR	118.1350.150	100	20x1.5	27	41.0	12.0x1.5	22.0	12.0	4.100
SO 11345-18 OR	118.1350.180	100	24x1.5	32	41.0	15.0x2.0	22.0	15.0	5.600
SO 11345-22 OR	118.1350.220	64	28x1.5	36	41.0	18.0x2.0	22.0	18.0	6.700

Anwendungsbeispiele:

Exemples d'utilisation:

Sample combinations:

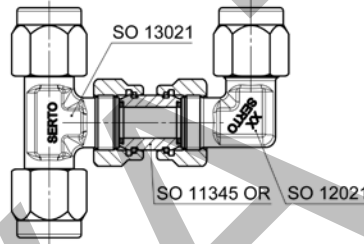

Einsatztemperaturbereich: -20 °C bis +120 °C

Mit der einstellbaren Verschraubung lassen sich verschiedene Grundteile einfach verbinden. Kompakte Bauweise, schnelle Montage, einfache Fixierung der Komponenten in der gewünschten Stellung.

Beachten Sie auch die Möglichkeiten mit SO 11335 OR.

d = Kenngröße: entspricht dem Rohraussen- ϕ des Armaturenanschlusses SO 10021, der gegen die einstellbare Verschraubung SO 11345 OR ausgetauscht werden kann.

Montagehinweis: Beide Anschlussmutter mit 1/8 Umdrehung anziehen. Wir empfehlen eine zusätzliche Schmierung auf der Planfläche.

Plage de température de service: -20 °C à +120 °C

L'union orientable permet de connecter facilement différents corps de raccord. Construction compacte, montage rapide, fixation facile des composants dans la position désirée.

Voir également les possibilités avec SO 11335 OR.

d = dimension nominale: correspond au dia. extérieur du tube de l'écrou et bague de raccordement SO 10021, lequel peut être échangé contre l'union orientable SO 11345 OR.

Note d'installation: Serrez les deux écrous de 1/8 de tour. Nous recommandons une lubrification supplémentaire sur la surface plane.

Operating temperature range: -20 °C to +120 °C

With the adjustable union different basic components can easily be connected. Compact construction, quick assembly, and easy fixing of the components in the desired position.

See SO 11335 OR for additional possibilities.

d = nominal size: corresponds to tube outside dia. of the nut connection SO 10021 which can be replaced by the adjustable union SO 11345 OR.

Assembly information: Tighten both union nuts with 1/8 turn. We recommend additional lubrication on the plane surface.

Gerade Schottverschraubung

Durchführungslänge max. 16 mm

Union double traversée de cloison

pour cloison max. 16 mm

Panel mount union

max. panel thickness 16 mm

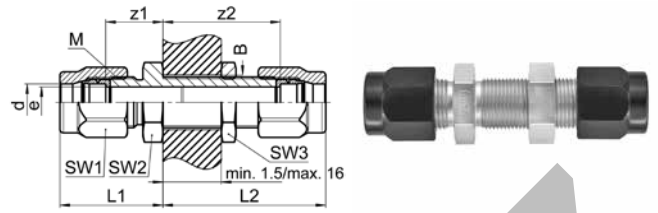

SO 11524

Type-d	Mat.-Nr.	bar	M	SW1	SW2	SW3	L1	L2	B	z1	z2	e	kg/100
SO 11524-10	118.1540.100	100	14x1.0	17	19	19	26.0	43.5	14.5	15.5	33.0	8.0	2.900
SO 11524-12	118.1540.120	100	16x1.0	19	22	22	28.0	46.0	16.5	16.0	34.0	9.0	4.300
SO 11524-18	118.1540.180	100	24x1.5	30	30	30	37.0	56.0	24.5	23.5	42.5	15.0	12.400
SO 11524-22	118.1540.220	64	28x1.5	32	36	36	41.0	61.0	28.5	24.5	44.5	18.0	15.800

Sechskantmutter siehe SO 10006 METR

Ecrou à six pans voir SO 10006 METR

Hexagon nut see SO 10006 METR

KROVAVIA

d=Rohrassens-ø
e=kleinste Bohrung
L=Mass in montiertem Zustand

d=ø extérieur du tube
e=ø-min. de passage
L=après montage

d=tube outside diameter
e=minimum bore
L=installed length

Winkelverschraubung Coude Elbow union

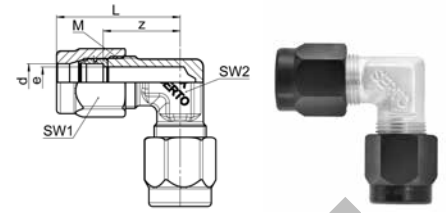

SO 12021

Type-d	Mat.-Nr.	bar	M	SW1	SW2	L	z	e	kg/100
SO 12021-10	118.2000.100	100	14x1.0	17	14	31.0	20.5	8.0	2.400
SO 12021-12	118.2000.120	100	16x1.0	19	17	33.5	21.5	9.0	3.200
SO 12021-15	118.2000.150	100	20x1.5	24	19	41.0	28.5	12.0	6.000
SO 12021-18	118.2000.180	100	24x1.5	30	22	44.0	30.5	15.0	9.500
SO 12021-22	118.2000.220	64	28x1.5	32	27	48.0	31.5	18.0	10.900
SO 12021-28	118.2000.280	64	36x2.0	41	32	56.5	40.0	24.0	20.100
SO 12021-35	118.2000.350	40	42x2.0	50	41	62.0	45.0	30.0	31.600

Winkel-Schottverschraubung

Durchführungslänge max. 5 mm

Coude traversée de cloison

pour cloison max. 5 mm

Panel mount elbow union

max. panel thickness 5 mm

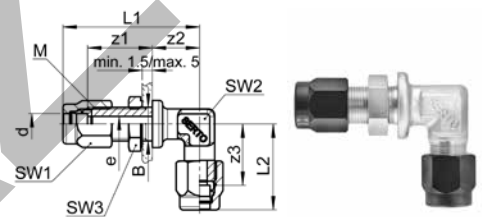

SO 12721

Type-d	Mat.-Nr.	bar	M	SW1	SW2	SW3	L1	L2	B	z1	z2	z3	e	kg/100
SO 12721-10	118.2700.100	100	14x1.0	17	17	19	52.0	34.0	14.5	23.0	18.0	23.5	8.0	4.100

Sechskantmutter siehe SO 10006 METR

Ecrou à six pans voir SO 10006 METR

Hexagon nut see SO 10006 METR

Schwenkverschraubung

Coude banjo

Single banjo

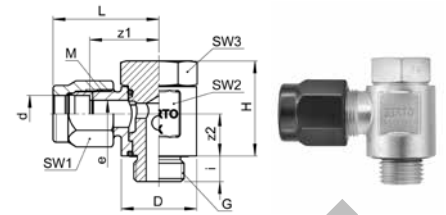

SO 12824

Type -d -G	Mat.-Nr.	bar	M	SW1	SW2	SW3	L	D	H	i	z1	z2	e	kg/100
SO 12824-8-1/8	118.2841.160	100	12x1.0	14	14	13	26.0	15.0	20.5	6.5	17.5	9.0	5.5	1.400
SO 12824-10-1/4	118.2841.270	100	14x1.0	17	19	17	32.0	20.0	28.0	8.5	21.0	12.5	6.5	2.900
SO 12824-12-3/8	118.2841.390	100	16x1.0	19	24	22	35.0	25.0	31.5	8.5	23.0	14.0	8.5	4.800
SO 12824-15-1/2	118.2841.534	100	20x1.5	24	30	27	42.0	30.0	38.0	10.0	29.5	17.0	12.0	8.400

O-Ringe: FKM

Joints: FKM

O-Rings: FKM

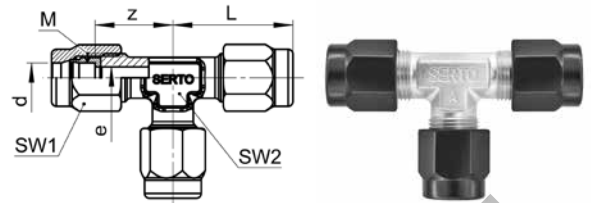
T-Verschraubung
Té égal
Tee union
SO 13021

Type-d	Mat.-Nr.	bar	M	SW1	SW2	L	z	e	kg/100
SO 13021-10	118.3000.100	100	14x1.0	17	14	31.0	20.5	8.0	3.400
SO 13021-12	118.3000.120	100	16x1.0	19	17	33.5	21.5	9.0	4.500
SO 13021-15	118.3000.150	100	20x1.5	24	19	39.0	26.0	12.0	8.100
SO 13021-18	118.3000.180	100	24x1.5	30	22	44.0	30.5	15.0	13.300
SO 13021-22	118.3000.220	64	28x1.5	32	27	48.0	31.5	18.0	15.800
SO 13021-28	118.3000.280	64	36x2.0	41	32	56.5	40.0	24.0	28.400
SO 13021-35	118.3000.350	40	42x2.0	50	41	62.0	45.0	30.0	43.300

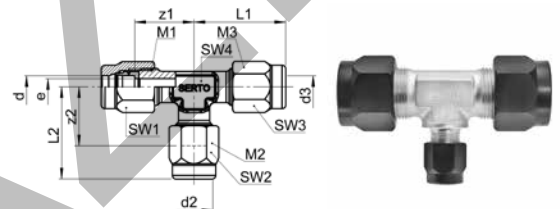
T-Verschraubung reduziert
Té réduit
Tee reduction union
SO 13021 RED

Type-d-d2-d3	Mat.-Nr.	bar	M1	M2	M3	SW1	SW2	SW3	SW4	L1	L2	z1	z2	e	kg/100
SO 13021-18-10-18	118.3004.584	100	24x1.5	14x1.0	24x1.5	30	17	30	22	43.0	36.5	29.5	28.0	8.0	10.700
SO 13021-18-12-18	118.3004.599	100	24x1.5	16x1.0	24x1.5	30	19	30	22	43.0	38.0	29.5	28.0	9.0	10.900
SO 13021-22-12-22	118.3004.740	64	28x1.5	16x1.0	28x1.5	32	19	32	27	48.0	40.0	31.5	30.0	9.0	13.300
SO 13021-22-18-22	118.3004.862	64	28x1.5	24x1.5	28x1.5	32	30	32	27	48.0	45.0	31.5	33.5	15.0	15.600

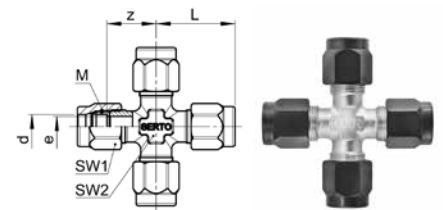
Kreuzverschraubung
Croix égale
Cross union
SO 14021

Type-d	Mat.-Nr.	bar	M	SW1	SW2	L	z	e	kg/100
SO 14021-12	118.4000.120	100	16x1.0	19	14	33.5	21.5	9.0	5.400

**SO 10511 OR**

Einschraubtülle G mit Conovor
O-Ringabdichtung (FKM)
Douille cannelée à visser G avec joint
torique système Conovor (FKM)
Male adaptor hose nozzle G with Conovor
O-ring seal (FKM)

700

KROVAVANZ.CZ

SERTO CAD Bibliothek

- technische Daten und Zeichnungen aller Katalogartikel
- kostenfreie Downloads
- im benötigten CAD-Format

Bibliothèque CAO de SERTO

- données techniques et plans de tous les articles du catalogue
- téléchargements gratuits
- dans le format CAO désiré

SERTO CAD Library

- technical data and drawings of all catalog items
- free downloads
- in the desired CAD format



serto.partcommunity.com



Stahl

Verschraubungen

Acier

Raccords

Steel

Unions



durchgestrichene Artikel sind ausverkauft - nicht mehr Verfügbar
les articles barrés sont épuisés - ne plus disponibles
crossed out items are sold out - no longer available

	Seite/Page/Page		Seite/Page/Page		Seite/Page/Page
Abschlusszapfen Bouchon d'arrêt Plug	356 	Gerade Verschraubung Union double Straight union	365 	Einstellbare Einschraubverschraubung Union mâle orientable Adjustable male adaptor union	377-378
Stützhülse Douille d'appui Stiffener sleeve	357 	Reduziernippel Réduction femelle-mâle Male reduction nipple	366 	Anschweißverschraubung Union simple avec embout à souder Weld-on union	379
Winkelverschraubung Coude Elbow union	358 	Reduktionsverschraubung Union de réduction Reduction union	367 	Einstellbare Verschraubung Union orientable Adjustable union	380-381
Winkel-Einschraubverschraubung Coude mâle Male adaptor elbow union	359 	Sechskantmutter METR Ecrou à six pans METR Hexagon nut METR	368 	Klemmring Bague de serrage Compression ferrule	382
Winkel-Schottverschraubung Coude traversée de cloison Panel mount elbow union	360 	Gerade Einschraubverschraubung Union mâle Male adaptor union	369-370 	Anschlussmutter, -nippel Écrou, Écrou mâle Union nut, Nipple	382-383
Einstellbare Winkelverschraubung Coude orientable Adjustable elbow union	361 	Thermofühlerverschraubung Raccord pour sondes Temperature probe union	371-374 	Sonderausführungen auf Anfrage Exécution en option sur demande Optional services on request	
Schwenkverschraubung Coude banjo Single banjo	362 	Gerade Aufschraubverschraubung Union femelle Female adaptor union	375 	Vorbeschichtete Gewinde PTFE-Band umwickelt Filetages pré enduits avec ruban en PTFE Pre-coated threads with PTFE-tape Vorbeschichtete Gewinde mit Loctite 5061 Filetages pré enduits avec Loctite 5061 Pre-coated threads with Loctite 5061	
T-Verschraubung Té égal Tee union	363-365 	Gerade Schottverschraubung Union double traversée de cloison Panel mount union	376 	Bestätigungen auf www.serto.com Confirmations sur www.serto.com Confirmations on www.serto.com	



Eigenschaften, Besonderheiten

- einfache, schnelle Montage
- kompakte Baumassee
- grosse Sortimentsvielfalt
- viele Kombinationsmöglichkeiten
- hohe Betriebsdrücke

Funktionsprinzip

Siehe Kapitel i

Werkstoff

Stahl nach DIN 3859
mit Chrom-VI-freiem Korrosionsschutz ¹⁾

Betriebsdruck PN

Siehe Produkttabellen (4-fache Sicherheit)

Temperaturbereich

-40°C bis +200°C

Helium-Leckrate

10⁻⁸mbar • l/s *

Anzuschliessende Rohre

Nahtlose Präzisionsrohre nach EN 10305-1 aus Stahl 35.4, normalblankgeglüht (NBK), blank oder rostschutzgebondert. Toleranz Aussendurchmesser ± 0.1 mm, Rohre Ø < 6 mm Toleranz ± 0.05 mm. Siehe auch Kapitel i und Kapitel 19. Weitere Materialien auf Anfrage.

Einschraubzapfen, Gewinde

Rohrgewinde (Zoll) und metrisches Feingewinde DIN 3852, kegelig nach Form C, mit Dichtkante nach Form B.

Zum Abdichten der kegeligen Einschraubgewinde empfehlen wir das PTFE Band AC 840/841 oder Loctite 5061.

¹⁾ entspricht Richtlinien 2002/95/EG und 2000/53/EG

Druckauswertungsgrad in % des PN

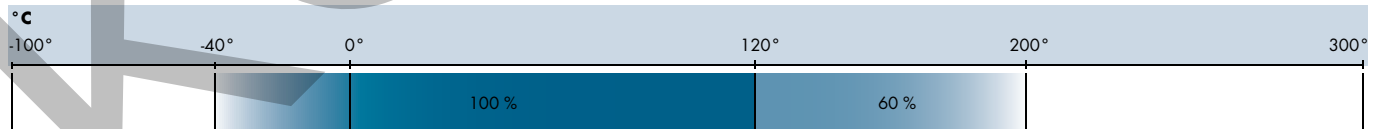

* bei fachgerechter Montage; siehe Kapitel i:
- Montageanleitung
- Rohrempfehlungen

Propriétés, spécificités

- montage facile et rapide
- compactes dimensions
- programme étendu
- multiples possibilités de combinaisons
- pressions de service élevées

Principe de fonctionnement

Voir chapitre i

Matériau

Acier selon DIN 3859
avec protection anticorrosion sans chrome VI ¹⁾

Pression de service PN

Voir tableaux des produits (facteur de sécurité 4)

Plage de température admissible

-40°C à +200°C

Débit de fuite avec hélium

10⁻⁸mbar • l/s *

Tubes à utiliser

Tubes de précision sans soudure selon EN 10305-1 en acier 35.4, recuit blanc (NBK), exécution polie ou bondérisée. Tolérance du diamètre extérieur de ± 0.1 mm, tubes Ø < 6 mm tolerance ± 0.05 mm. Voir aussi chapitre i et chapitre 19. Autres matériaux sur demande.

Emboutis mâles, filetages

Filetage-gaz (BSP) et filetage métrique à pas fin DIN 3852, conique selon forme C, filetage d'étanchéité selon forme B.

Pour assurer l'étanchéité des filetages mâles coniques, nous recommandons le ruban en PTFE AC 840/841 ou Loctite 5061.

¹⁾ selon directive 2002/95/CE et 2000/53/CE

Coefficient de pression de service admissible en % de PN

Characteristics, specialities

- easy and fast to install
- compact size
- wide selection of compatible components
- extensive range of combinations
- high operating pressures

Operating principle

See chapter i

Material

Steel according DIN 3859
with chrome VI-free corrosion protection ¹⁾

Working pressure PN

See product tables (safety factor 4)

Temperature range

-40°C to +200°C

Leak rate with helium

10⁻⁸mbar • l/s *

Tubes to use

Seamless precision steel tubes conforming to EN 10305-1 of steel 35.4, normalized bright annealed (NBK) with bright or rust preventative bonded finish. Tolerance of outside diameter ± 0.1 mm, tubes Ø < 6 mm tolerance ± 0.05 mm. See also chapter i and chapter 19. Further materials on request.

Adaptor stem, male thread

British Standard Pipe (BSP) and metric fine thread DIN 3852, tapered form C, thread with edge seal form B.

For sealing of the tapered male adaptor thread we recommend the PTFE tape AC 840/841 or Loctite 5061.

¹⁾ according to directives 2002/95/EC and 2000/53 EC

Pressure coefficient % of PN

* à la base d'un montage dans les règles de l'art; voir chapitre i:
- Instructions de montage
- Recommandations pour tubes

* when professionally assembled; see chapter i:
- Installation instructions
- Recommendations for tubes

Abschlusszapfen

Bouchon d'arrêt

Plug

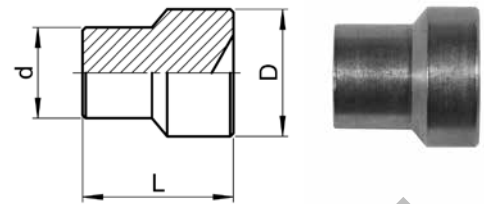

SO 40002

Type-d	Mat.-Nr.	L	D	kg/100
SO 40002-4	016.0020.040	8.0	6.8	0.150
SO 40002-5	016.0020.050	8.5	6.8	0.190
SO 40002-6	016.0020.060	10.0	8.4	0.320
SO 40002-8	016.0020.080	10.5	10.5	0.570
SO 40002-10	016.0020.100	13.0	12.7	0.970
SO 40002-12	016.0020.120	14.0	14.8	1.550
SO 40002-14/15	016.0020.140	15.0	17.5	2.220
SO 40002-17/18	016.0020.170	17.2	21.0	3.680
SO 40002-22	016.0020.220	19.0	26.0	6.300
SO 40002-28	016.0020.280	22.5	32.5	12.320
SO 40002-35	016.0020.350	25.2	39.5	21.300

Anwendungsbeispiele:

Exemples d'utilisation:

Sample combinations:

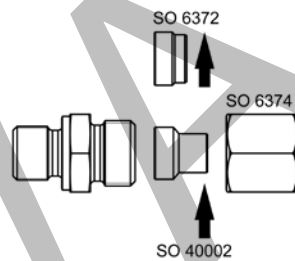

Werkstoff: Messing

Der Abschlusszapfen lässt sich in jede Verschraubung anstelle eines Klemmringes der gleichen Grösse einsetzen.

Montagehinweis: Anschlussmutter mit 1/4 Umdrehung anziehen.

Matériau: Laiton

Le bouchon d'arrêt s'insère dans tout raccord au lieu d'une bague de serrage de la même taille.

Note d'installation: Serrez l'écrou d'accouplement de 1/4 de tour.

Material: Brass

The plug can be inserted into all screw fittings instead of a compression ferrule of the same size.

Assembly information: Tighten the union nut with 1/4 turn.

Stützhülse

zur Rohrverstärkung

Douille d'appui

pour renforcer les tubes

Stiffener sleeve

to reinforce tubes

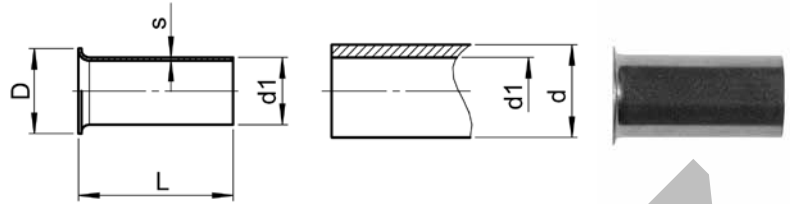

SO 40003

Type - d - d1	Mat.-Nr.	L	D	s	kg/100
SO 40003-6-3	016.0030.100	10.0	5.2	0.20	0.015
SO 40003-6-4	016.0030.110	10.0	5.5	0.20	0.025
SO 40003-6-4,4	016.0030.113	10.0	5.5	0.20	0.025
SO 40003-6-4,65	016.0030.116	10.0	5.5	0.20	0.025
SO 40003-6-4,7 D	016.0030.118	10.0	5.5	0.40	0.046
SO 40003-8-5	016.0030.136	12.0	7.5	0.25	0.040
SO 40003-8-5,5	016.0030.138	12.0	7.5	0.25	0.045
SO 40003-8-6	016.0030.140	12.0	7.5	0.25	0.045
SO 40003-8-6,4	016.0030.144	12.0	7.5	0.25	0.050
SO 40003-10-7	016.0030.180	16.0	9.5	0.30	0.080
SO 40003-10-7,5	016.0030.185	16.0	9.5	0.30	0.090
SO 40003-10-8 D	016.0030.189	16.0	9.5	0.60	0.190
SO 40003-10-8	016.0030.190	16.0	9.5	0.30	0.100
SO 40003-10-8,4	016.0030.192	16.0	9.5	0.30	0.095
SO 40003-10-8,6	016.0030.193	16.0	9.5	0.30	0.095
SO 40003-12-9	016.0030.230	20.0	11.5	0.40	0.190
SO 40003-12-9,5	016.0030.235	20.0	11.5	0.40	0.195
SO 40003-12-10	016.0030.240	20.0	11.5	0.40	0.195
SO 40003-12-10,4	016.0030.254	20.0	11.5	0.40	0.195
SO 40003-12-11 D	016.0030.257	20.0	12.0	1.00	0.500
SO 40003-14-11	016.0030.330	20.0	12.5	0.50	0.330
SO 40003-14-11,5	016.0030.335	24.0	13.5	0.50	0.350
SO 40003-14-12	016.0030.340	24.0	13.5	0.50	0.370
SO 40003-15-12,5	016.0030.425	24.0	14.5	0.50	0.390
SO 40003-15-13	016.0030.430	24.0	14.5	0.50	0.390
SO 40003-16-13,5	016.0030.495	26.0	15.5	0.50	0.430
SO 40003-16-14 D	016.0030.499	26.0	15.5	1.00	0.900
SO 40003-16-14	016.0030.500	26.0	15.5	0.50	0.470
SO 40003-18-15	016.0030.610	26.0	16.5	0.60	0.590
SO 40003-18-15,6	016.0030.616	26.0	17.5	0.60	0.610
SO 40003-18-16	016.0030.620	26.0	17.5	0.60	0.630
SO 40003-20-18	016.0030.700	28.0	19.5	0.60	0.830
SO 40003-22-19	016.0030.760	30.0	21.5	0.60	0.850
SO 40003-22-19,6	016.0030.771	30.0	21.5	0.60	0.940
SO 40003-22-20	016.0030.775	30.0	21.5	0.60	0.980
SO 40003-28-25	016.0030.870	36.0	27.5	0.80	1.500
SO 40003-28-25,6	016.0030.876	36.0	27.5	0.80	1.600

Werkstoff: Messing CW508L

Matériau: Laiton CW508L

Material: Brass CW508L

Verstärken:

Dünnwandige und weiche Rohre sowie alle Kunststoffrohre sind mit Stützhülsen zu verstärken. Genaue Angaben über das Verstärken siehe Kapitel i.

Hilfswerkzeuge zum Entgraten und Kalibrieren der Rohre siehe Kapitel 21.

Renforcement:

Tubes à paroi mince et tubes souples et tubes en plastique doivent être renforcés à l'aide de douilles d'appui. Pour des indications concernant le renforcement voir chapitre i.

Pour des outils pour l'ébarbage et le calibrage du tube voir chapitre 21.

Reinforcement:

Thin walled, soft tubes and all plastic tubes are to be reinforced with stiffener sleeves.

Details concerning stiffening are to be found in chapter i.

For useful tools for deburring and calibrating tubes see chapter 21.

Typenbezeichnung mit D: für weiches oder sehr dünnwandiges Kupferrohr.

Types avec D: pour des tubes de cuivre mous ou à parois très minces.

Types with D: for soft or very thin-walled copper tubes.

d=Rohraussen- \emptyset
d1=Rohrinnen- \emptyset
s=Rohrwandstärke

d= \emptyset extérieur du tube
d1= \emptyset intérieur de tube
s=épaisseur de la paroi du tube

d=tube outside diameter
d1=tube inside diameter
s=tube wall thickness

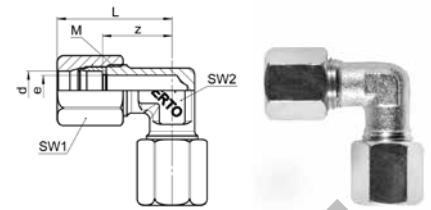
Winkelverschraubung
Coude
Elbow union

SO 6090

Type-d	Mat.-Nr.	bar	M	SW1	SW2	L	z	e	kg/100
SO 6090-6	218.2000.060	400	12x1.5	14	12	28.0	20.0	5.0	4.000
SO 6090-8	218.2000.080	300	14x1.5	17	12	30.0	22.0	6.0	6.200
SO 6090-10	218.2000.100	250	16x1.5	19	14	33.0	23.0	7.0	9.000
SO 6090-12	218.2000.120	250	18x1.5	22	17	37.0	25.0	9.0	12.700
SO 6090-14	218.2000.140	250	22x1.5	27	19	42.0	29.0	11.0	21.500
SO 6090-15	218.2000.150	200	22x1.5	27	19	42.0	29.0	11.0	21.500
SO 6090-16	218.2000.160	200	24x1.5	30	22	46.0	31.0	12.0	28.200
SO 6090-18	218.2000.180	200	26x1.5	32	24	48.0	32.0	14.0	32.400
SO 6090-20	218.2000.200	200	26x1.5	32	24	50.0	32.5	14.0	33.800
SO 6090-22	218.2000.220	160	30x2.0	36	27	51.0	37.0	18.0	42.400
SO 6090-25	218.2000.250	160	33x2.0	41	30	57.0	40.0	20.0	61.500
SO 6090-28	218.2000.280	160	36x2.0	41	36	56.0	40.0	24.0	58.800

d=Rohrussen- \varnothing
 e=kleinste Bohrung
 L=Mass in montiertem Zustand

d= \varnothing extérieur du tube
 e= \varnothing -min. de passage
 L=après montage

d=tube outside diameter
 e=minimum bore
 L=installed length

Winkel-Einschraubverschraubung

Coude mâle

Male adaptor elbow union

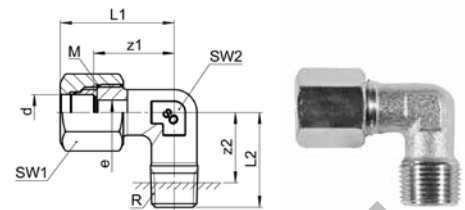
SO 6092

Type -d -R	Mat.-Nr.	bar	M	SW1	SW2	L1	L2	z1	z2	e	kg/100
R=Rohrgewinde (kegelig)	R=Filetage-gaz BSP (conique)	R=BSP thread (tapered)									
SO 6092-6-1/8	218.2401.100	400	12x1.5	14	12	28.0	20.0	20.0	15.0	5.0	3.100
SO 6092-6-1/4	218.2401.110	400	12x1.5	14	12	30.0	26.0	22.0	18.0	5.0	4.000
SO 6092-8-1/8	218.2401.160	300	14x1.5	17	12	30.0	26.0	22.0	21.0	5.0	4.300
SO 6092-8-1/4	218.2401.170	300	14x1.5	17	12	30.0	26.0	22.0	18.0	6.0	4.600
SO 6092-10-1/4	218.2401.270	250	16x1.5	19	14	32.5	27.0	23.0	19.0	7.0	6.400
SO 6092-10-3/8	218.2401.280	250	16x1.5	19	14	32.5	26.0	23.0	18.0	7.0	8.300
SO 6092-12-3/8	218.2401.390	250	18x1.5	22	17	37.0	28.0	25.0	20.0	9.0	8.600
SO 6092-14-3/8	218.2401.502	250	22x1.5	27	19	42.0	32.0	29.0	24.0	11.0	14.500
SO 6092-14-1/2	218.2401.504	250	22x1.5	27	19	42.0	32.0	29.0	22.0	11.0	15.600
SO 6092-15-3/8	218.2401.532	200	22x1.5	27	19	42.0	32.0	29.0	24.0	11.0	14.500
SO 6092-15-1/2	218.2401.534	200	22x1.5	27	19	42.0	32.0	29.0	22.0	11.0	15.600
SO 6092-16-1/2	218.2401.566	200	24x1.5	30	22	46.0	35.0	31.0	25.0	12.0	19.600
SO 6092-18-1/2	218.2401.646	200	26x1.5	32	24	48.0	36.0	32.0	26.0	14.0	21.700
SO 6092-18-3/4	218.2401.648	200	26x1.5	32	24	48.0	35.0	32.0	23.0	14.0	24.800
SO 6092-20-1/2	218.2401.706	200	26x1.5	32	24	50.0	36.0	33.0	26.0	14.0	21.700
SO 6092-20-3/4	218.2401.708	200	26x1.5	32	24	50.0	35.0	33.0	23.0	14.0	24.810
SO 6092-22-3/4	218.2401.768	160	30x2.0	32	27	51.0	39.0	37.0	27.0	19.0	28.800
SO 6092-25-1	218.2401.810	160	33x2.0	41	30	57.0	44.0	40.0	30.0	20.0	43.900
SO 6092-28-1	218.2401.850	160	36x2.0	41	30	56.0	46.0	40.0	32.0	24.0	39.400

d=Rohrassen-ø
e=kleinste Bohrung
L=Mass in montiertem Zustand

d=ø extérieur du tube
e=ø-min. de passage
L=après montage

d=tube outside diameter
e=minimum bore
L=installed length

Winkel-Schottverschraubung

Durchführungslänge max. 20 mm

Coude traversée de cloison

pour cloison max. 20 mm

Panel mount elbow union

max. panel thickness 20 mm

SO 6093

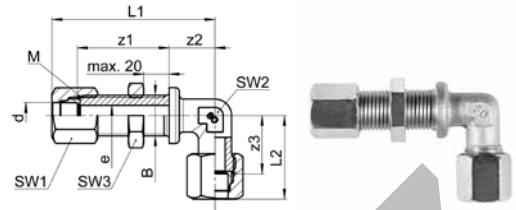

Type -d	Mat.-Nr.	bar	M	SW1	SW2	SW3	L1	L2	B	z1	z2	z3	e	kg/100
SO 6093-6	218.2700.060	400	12x1.5	14	12	17	57.0	28.0	14.0	35.0	14.0	20.0	5.0	7.100
SO 6093-8	218.2700.080	300	14x1.5	17	12	19	60.0	30.0	16.0	35.0	17.0	22.0	6.0	9.600
SO 6093-10	218.2700.100	250	16x1.5	19	14	22	64.0	33.0	18.0	36.0	18.0	23.0	8.0	13.500
SO 6093-12	218.2700.120	250	18x1.5	22	17	24	69.0	37.0	20.0	37.0	20.0	25.0	10.0	17.800
SO 6093-14	218.2700.140	250	22x1.5	27	19	30	75.0	42.0	23.0	39.0	23.0	29.0	11.0	31.000
SO 6093-15	218.2700.150	200	22x1.5	27	19	30	75.0	42.0	23.0	39.0	23.0	29.0	11.0	29.600
SO 6093-16	218.2700.160	200	24x1.5	30	24	32	78.0	46.0	24.0	39.0	24.0	31.0	12.0	39.000
SO 6093-18	218.2700.180	200	26x1.5	32	24	36	81.0	48.0	24.0	41.0	24.0	32.0	16.0	44.300
SO 6093-20	218.2700.200	200	26x1.5	32	24	36	83.0	50.0	24.0	41.0	24.0	32.0	16.0	45.700
SO 6093-22	218.2700.220	160	30x2.0	36	27	41	88.0	51.0	30.0	44.0	30.0	37.0	19.0	57.200

Sechskantmutter siehe SO 6310

Ecrou à six pans voir SO 6310

Hexagon nut see SO 6310

Einstellbare Winkelverschraubung

Coude orientable

Adjustable elbow union

SO 6095

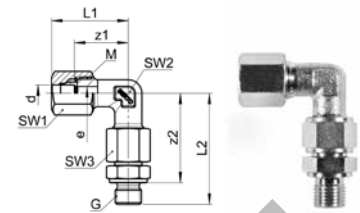

Type -d-G	Mat.-Nr.	bar	M	SW1	SW2	SW3	L1	L2	z1	z2	e	kg/100
G=Rohrgewinde (zylindrisch)			G=Filetage-gaz BSP (cylindrique)									
			G=BSP thread (parallel)									
SO 6095-6-1/8	218.2641.100	400	12x1.5	14	12	14	28.0	41.0	20.0	33.0	4.0	5.000
SO 6095-8-1/4	218.2641.170	300	14x1.5	17	12	17	30.0	48.5	22.0	36.5	6.0	8.100
SO 6095-10-1/4	218.2641.270	250	16x1.5	19	14	19	33.0	50.0	23.0	38.0	7.0	10.400
SO 6095-12-3/8	218.2641.390	250	18x1.5	22	17	22	37.0	53.0	25.0	41.0	9.0	14.800
SO 6095-14-1/2	218.2641.504	250	22x1.5	27	19	27	42.0	61.0	29.0	47.0	11.0	25.300
SO 6095-15-1/2	218.2641.534	200	22x1.5	27	19	27	42.0	61.0	29.0	47.0	11.0	25.300
SO 6095-16-1/2	218.2641.566	200	24x1.5	30	22	30	46.0	64.0	31.0	50.0	12.0	31.500
SO 6095-18-1/2	218.2641.646	200	26x1.5	32	24	32	48.0	65.0	32.0	51.0	14.0	35.000
SO 6095-18-3/4	218.2641.648	200	26x1.5	32	24	32	48.0	67.0	32.0	51.0	14.0	38.000
SO 6095-20-1/2	218.2641.706	200	26x1.5	32	24	32	50.0	65.0	33.0	51.0	14.0	35.000
SO 6095-20-3/4	218.2641.708	200	26x1.5	32	24	32	50.0	67.0	33.0	51.0	14.0	38.000
SO 6095-22-3/4	218.2641.768	160	30x2.0	36	27	36	51.0	73.0	37.0	57.0	18.0	47.200
SO 6095-25-1	218.2641.810	160	33x2.0	41	30	41	57.0	81.0	40.0	63.0	20.0	72.000
SO 6095-28-1	218.2641.850	160	36x2.0	41	36	41	56.0	81.0	40.0	63.0	23.0	69.200

Die einstellbare Winkelverschraubung SO 6095 ist eine Kombination aus der einstellbaren Einschraubverschraubung SO 6335 und der Winkelverschraubung SO 6090. Die einstellbare Einschraubverschraubung SO 6335 ist nur lose montiert und muss bei der Endmontage mit 1/4 Umdrehung angezogen werden. Wir empfehlen vor der Endmontage eine zusätzliche Schmierung auf der Planfläche.

Le coude orientable SO 6095 est une combinaison de l'union mâle orientable SO 6335 et du coude SO 6090. L'union mâle orientable SO 6335 est livré monté sans être serré et doit être serré de 1/4 de tour pour le montage final. Nous recommandons une lubrification supplémentaire sur la surface plane.

The adjustable elbow union SO 6095 is a combination of the adjustable male adaptor union SO 6335 and the elbow union SO 6090. The adjustable male adaptor union SO 6335 is fitted only loosely and must be tightened with 1/4 turn for final assembly. We recommend additional lubrication on the plane surface.

Schwenkverschraubung

Coude banjo

Single banjo

SO 6096

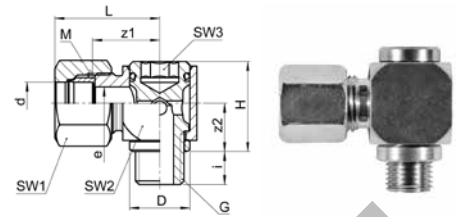

Type -d -G	Mat.-Nr.	bar	M	SW1	SW2	SW3	L	D	H	i	z1	z2	e	kg/100
G=Rohrgewinde (zylindrisch)				G=Filetage-gaz BSP (cylindrique)					G=BSP thread (parallel)					
SO 6096-6-1/8	218.2841.100	400	12x1.5	14	18	6	28.0	14.0	22.0	8.0	20.0	12.0	4.0	6.100
SO 6096-8-1/4	218.2841.170	300	14x1.5	17	22	8	30.0	18.0	28.0	12.0	22.0	16.0	6.0	10.200
SO 6096-10-1/4	218.2841.270	250	16x1.5	19	22	8	33.0	18.0	28.0	12.0	23.0	16.0	7.0	11.600
SO 6096-12-3/8	218.2841.390	250	18x1.5	22	28	10	38.0	22.0	33.0	12.0	26.0	18.0	9.0	19.300
SO 6096-14-1/2	218.2841.504	250	22x1.5	27	30	12	41.0	26.0	37.0	14.0	28.0	20.0	11.0	27.800
SO 6096-15-1/2	218.2841.534	200	22x1.5	27	30	12	41.0	26.0	37.0	14.0	28.0	20.0	11.0	27.800
SO 6096-16-1/2	218.2841.566	200	24x1.5	30	32	14	44.0	26.0	39.0	14.0	29.0	21.0	12.0	32.000
SO 6096-18-1/2	218.2841.646	200	26x1.5	32	32	14	45.0	26.0	39.0	14.0	29.0	21.0	14.0	33.300
SO 6096-18-3/4	218.2841.648	200	26x1.5	32	40	17	51.0	32.0	47.0	17.0	35.0	25.0	16.0	56.300
SO 6096-20-1/2	218.2841.706	200	26x1.5	32	32	14	47.0	26.0	39.0	14.0	30.0	21.0	14.0	33.300
SO 6096-20-3/4	218.2841.708	200	26x1.5	32	40	17	53.0	32.0	47.0	17.0	36.0	25.0	16.0	56.300
SO 6096-22-3/4	218.2841.768	160	30x2.0	36	40	17	50.0	32.0	47.0	17.0	36.0	25.0	18.0	60.200
SO 6096-25-1	218.2841.810	160	33x2.0	41	46	22	58.0	39.0	54.0	19.0	41.0	29.0	20.0	88.100
SO 6096-28-1	218.2841.850	160	36x2.0	41	46	22	57.0	39.0	54.0	19.0	41.0	29.0	24.0	79.400

Schwenkverschraubung METR

Coude banjo METR

Single banjo METR

SO 6096 METR

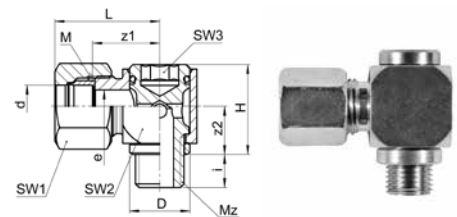

Type -d -Mz	Mat.-Nr.	bar	M	SW1	SW2	SW3	L	D	H	i	z1	z2	e	kg/100
Mz=metrisches Gewinde (zylindrisch)				Mz=Filetage métrique (cylindrique)					Mz=Metric thread (parallel)					
SO 6096-6-M10x1	218.2843.180	400	12x1.5	14	18	6	28.0	14.0	22.0	8.0	20.0	12.0	4.0	6.100
SO 6096-8-M12x1,5	218.2843.240	300	14x1.5	17	20	6	30.0	17.0	25.0	12.0	21.0	15.0	6.0	9.500
SO 6096-10-M14x1,5	218.2843.280	250	16x1.5	19	22	8	33.0	19.0	28.0	12.0	23.0	16.0	7.0	12.000
SO 6096-12-M16x1,5	218.2843.330	250	18x1.5	22	28	10	38.0	21.0	33.0	12.0	26.0	18.0	9.0	19.300
SO 6096-14-M18x1,5	218.2843.380	250	22x1.5	27	30	12	41.0	23.0	37.0	12.0	28.0	20.0	11.0	26.400
SO 6096-15-M18x1,5	218.2843.390	200	22x1.5	27	30	12	41.0	23.0	37.0	12.0	28.0	20.0	11.0	26.400
SO 6096-18-M22x1,5	218.2843.460	200	26x1.5	32	32	14	45.0	27.0	39.0	14.0	29.0	21.0	14.0	33.700
SO 6096-20-M22x1,5	218.2843.500	200	26x1.5	32	32	14	47.0	27.0	39.0	14.0	30.0	21.0	14.0	33.700
SO 6096-22-M26x1,5	218.2843.535	160	30x2.0	36	40	17	50.0	31.0	47.0	17.0	36.0	25.0	18.0	59.700
SO 6096-25-M33x2	218.2843.550	160	33x2.0	41	46	22	58.0	39.0	54.0	19.0	41.0	29.0	20.0	88.100
SO 6096-28-M33x2	218.2843.570	160	36x2.0	41	46	22	57.0	39.0	54.0	19.0	41.0	29.0	24.0	79.000

d=Rohrassens-ø
e=kleinste Bohrung
L=Mass in montiertem Zustand

d=ø extérieur du tube
e=ø-min. de passage
L=après montage

d=tube outside diameter
e=minimum bore
L=installed length

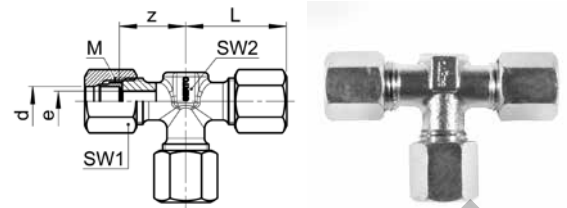
T-Verschraubung
Té égal
Tee union

SO 6130

Type-d	Mat.-Nr.	bar	M	SW1	SW2	L	z	e	kg/100
SO 6130-6	218.3000.060	400	12x1.5	14	12	28.0	20.0	5.0	6.600
SO 6130-8	218.3000.080	300	14x1.5	17	12	30.0	22.0	6.0	8.900
SO 6130-10	218.3000.100	250	16x1.5	19	14	33.0	23.0	7.0	13.700
SO 6130-12	218.3000.120	250	18x1.5	22	17	37.0	25.0	9.0	18.400
SO 6130-14	218.3000.140	250	22x1.5	27	19	42.0	29.0	11.0	32.800
SO 6130-15	218.3000.150	200	22x1.5	27	19	42.0	29.0	11.0	32.800
SO 6130-16	218.3000.160	200	24x1.5	30	22	46.0	31.0	12.0	42.700
SO 6130-18	218.3000.180	200	26x1.5	32	24	48.0	32.0	14.0	49.800
SO 6130-20	218.3000.200	200	26x1.5	32	24	49.5	32.5	14.0	51.300
SO 6130-22	218.3000.220	160	30x2.0	36	27	51.0	37.0	18.0	63.700
SO 6130-28	218.3000.280	160	36x2.0	41	36	56.0	40.0	24.0	86.600

KONVANT

d=Rohrussen-ø
e=kleinste Bohrung
L=Mass in montiertem Zustand

d=ø extérieur du tube
e=ø-min. de passage
L=après montage

d=tube outside diameter
e=minimum bore
L=installed length

Einstellbare T-Verschraubung

Té orientable au centre

Adjustable tee union

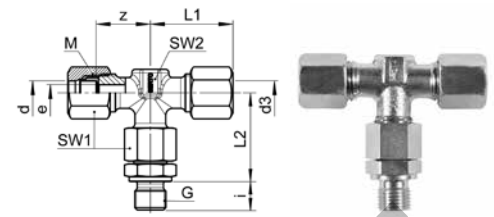

SO 6135

Type -d-G-d3	Mat.-Nr.	bar	M	SW1	SW2	L1	L2	i	z	e	kg/100
G=Rohrgewinde (zylindrisch)	G=Filetage-gaz BSP (cylindrique)		G=BSP thread (parallel)								
SO 6135-8-1/4-8	218.3651.170	300	14x1.5	17	12	31.0	37.0	12.0	22.0	6.0	11.000
SO 6135-10-1/4-10	218.3651.270	250	16x1.5	19	14	33.0	39.0	12.0	23.0	7.0	15.100
SO 6135-12-3/8-12	218.3651.390	250	18x1.5	22	17	37.0	41.0	12.0	25.0	9.0	20.500
SO 6135-14-1/2-14	218.3651.504	250	22x1.5	27	19	42.0	47.0	14.0	29.0	11.0	36.500
SO 6135-15-1/2-15	218.3651.534	200	22x1.5	27	19	42.0	47.0	14.0	29.0	11.0	36.500
SO 6135-16-1/2-16	218.3651.566	200	24x1.5	30	22	46.0	50.0	14.0	31.0	12.0	46.000
SO 6135-18-1/2-18	218.3651.646	200	26x1.5	32	24	48.0	51.0	14.0	32.0	14.0	52.300
SO 6135-18-3/4-18	218.3651.648	200	26x1.5	32	24	48.0	51.0	16.0	32.0	14.0	55.500
SO 6135-20-1/2-20	218.3651.706	200	26x1.5	32	24	49.5	51.0	14.0	32.5	14.0	52.300
SO 6135-20-3/4-20	218.3651.708	200	26x1.5	32	24	49.5	51.0	16.0	32.5	14.0	55.500
SO 6135-22-3/4-22	218.3651.768	160	30x2.0	36	27	51.0	57.0	16.0	37.0	18.0	68.500
SO 6135-25-1-25	218.3651.810	160	33x2.0	41	30	57.0	63.0	18.0	40.0	20.0	104.000
SO 6135-28-1-28	218.3651.850	160	36x2.0	41	36	56.0	63.0	18.0	40.0	24.0	97.000

Anwendungsbeispiele:

Exemples d'utilisation:

Sample combinations:

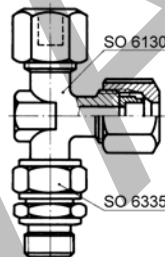

Die einstellbare T-Verschraubung SO 6135 ist eine Kombination aus der einstellbaren Einschraubverschraubung SO 6335 und der T-Verschraubung SO 6130.

Die einstellbare Einschraubverschraubung SO 6335 ist nur lose montiert und kann gegen den Anschluss SO 6372 und SO 6374 ausgetauscht werden. Bei der Endmontage muss mit 1/4 Umdrehung angezogen werden. Wir empfehlen vor der Endmontage eine zusätzliche Schmierung auf der Planfläche.

Weitere Kombinationen sind mit der reduzierten T-Verschraubung SO 6139 möglich.

Le té orientable SO 6135 est une combinaison de l'union mâle orientable SO 6335 et du té SO 6130.

L'union mâle orientable SO 6335 est livré monté sans être serré. Il peut être remplacé par l'écrou de raccord SO 6372 et SO 6374. Pour le montage final, serrer avec 1/4 de tour. Nous recommandons une lubrification supplémentaire sur la surface plane.

D'autres combinaisons sont possibles avec le té réduit SO 6139.

The adjustable tee union SO 6135 is a combination of the adjustable male adaptor union SO 6335 and the tee union SO 6130.

The adjustable male adaptor union SO 6335 is fitted only loosely and can be replaced by the connection SO 6372 and SO 6374. For final assembly, tighten with 1/4 turn. We recommend additional lubrication on the plane surface.

Further combinations can be obtained with the tee reduction union SO 6139.

T-Verschraubung reduziert
Té réduit
Tee reduction union

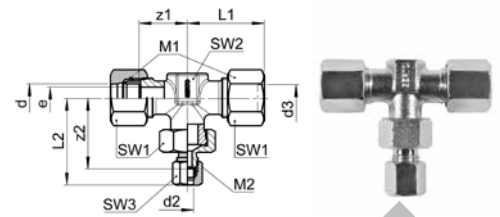

SO 6139

Type-d	d2-d3	Mat.-Nr.	bar	M1	M2	SW1	SW2	SW3	L1	L2	z1	z2	e	kg/100
SO 6139-12-8-12		218.3009.210	250	18x1.5	14x1.5	22	17	17	37.0	48.0	25.0	40.0	6.2	19.200
SO 6139-14-8-14		218.3009.320	250	22x1.5	14x1.5	27	19	17	42.0	52.0	29.0	44.0	6.2	32.800
SO 6139-14-10-14		218.3009.334	250	22x1.5	16x1.5	27	19	19	42.0	55.0	29.0	45.0	8.2	34.000
SO 6139-15-8-15		218.3009.393	200	22x1.5	14x1.5	27	19	17	42.0	52.0	29.0	44.0	6.2	32.800
SO 6139-15-10-15		218.3009.410	200	22x1.5	16x1.5	27	19	19	42.0	55.0	29.0	45.0	8.2	34.000
SO 6139-18-8-18		218.3009.568	200	26x1.5	14x1.5	32	24	17	48.0	55.0	32.0	47.0	6.2	48.200
SO 6139-18-15-18		218.3009.628	200	26x1.5	22x1.5	32	24	27	48.0	62.0	32.0	49.0	12.5	53.500

Gerade Verschraubung
Union double
Straight union

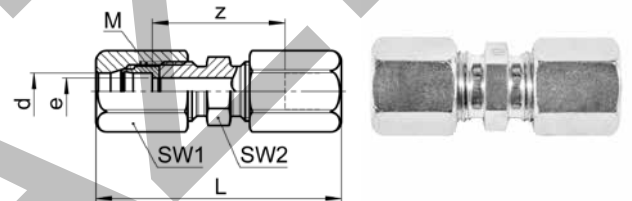

SO 6240

Type-d	Mat.-Nr.	bar	M	SW1	SW2	L	z	e	kg/100
SO 6240-6	218.1020.060	400	12x1.5	14	12	42.0	26.0	5.0	3.600
SO 6240-8	218.1020.080	300	14x1.5	17	14	43.0	27.0	6.2	5.300
SO 6240-10	218.1020.100	250	16x1.5	19	17	49.0	29.0	8.2	8.100
SO 6240-12	218.1020.120	250	18x1.5	22	19	54.0	30.0	10.2	11.200
SO 6240-14	218.1020.140	250	22x1.5	27	24	58.0	32.0	12.5	18.800
SO 6240-15	218.1020.150	200	22x1.5	27	24	58.0	32.0	12.5	18.800
SO 6240-16	218.1020.160	200	24x1.5	30	24	63.0	33.0	14.0	25.300
SO 6240-18	218.1020.180	200	26x1.5	32	27	65.0	33.0	16.0	27.800
SO 6240-20	218.1020.200	200	26x1.5	32	27	68.0	34.0	16.0	28.500
SO 6240-22	218.1020.220	160	30x2.0	36	32	67.0	39.0	19.0	36.200
SO 6240-25	218.1020.250	160	33x2.0	41	36	78.0	44.0	22.0	55.800
SO 6240-28	218.1020.280	160	36x2.0	41	41	72.0	40.0	25.0	44.300
SO 6240-30	218.1020.300	160	39x2.0	46	41	85.0	49.0	27.0	71.000

d=Rehraussen-ø
 e=kleinste Bohrung
 L=Mass in montiertem Zustand

d=ø extérieur du tube
 e=ø min. de passage
 L=après montage

d=tube outside diameter
 e=minimum bore
 L=installed length

Reduziernippel Réduction femelle-mâle Male reduction nipple

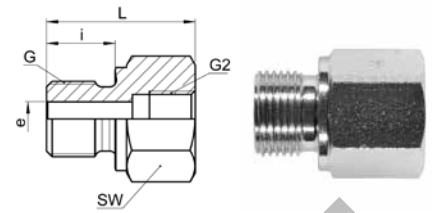

SO 6241

Type -G-G2	Mat.-Nr.	bar	SW	L	i	e	kg/100
G=Rohrgewinde (zylindrisch)							
G2=Rohrgewinde (zylindrisch)							
G=Filetage-gaz BSP (cylindrique)							
G2=Filetage-gaz BSP (cylindrique)							
G=BSP thread (parallel)							
G2=BSP thread (parallel)							
SO 6241-1/4-1/8	216.0441.102	400	19	26.0	12.0	6.0	3.400
SO 6241-1/4-3/8	216.0441.106	400	22	33.0	12.0	6.0	4.500
SO 6241-3/8-1/4	216.0441.164	400	22	32.0	12.0	9.0	5.700
SO 6241-3/8-1/2	216.0441.168	400	27	37.0	12.0	9.0	7.700
SO 6241-1/2-1/4	216.0441.224	400	27	24.0	14.0	13.5	5.600
SO 6241-1/2-3/8	216.0441.226	300	27	35.0	14.0	12.0	8.900
SO 6241-1/2-3/4	216.0441.232	300	32	43.0	14.0	14.0	18.500
SO 6241-3/4-1/4	216.0441.284	200	32	26.0	16.0	13.5	10.100
SO 6241-3/4-3/8	216.0441.286	200	32	26.0	16.0	17.0	8.800
SO 6241-3/4-1/2	216.0441.288	200	32	40.0	16.0	18.0	13.300
SO 6241-3/4-1	216.0441.296	160	41	48.0	16.0	18.0	19.600
SO 6241-1-1/2	216.0441.408	160	41	29.0	18.0	21.5	15.400
SO 6241-1-3/4	216.0441.412	160	41	46.0	18.0	20.0	26.600

Reduziernippel R Réduction femelle-mâle R Male reduction nipple R

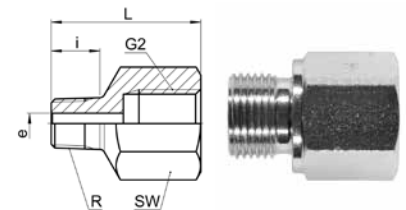

SO 6241 R

Type -R-G2	Mat.-Nr.	bar	SW	L	i	e	kg/100
R=Rohrgewinde (kegelig)							
G2=Rohrgewinde (zylindrisch)							
R=Filetage-gaz BSP (conique)							
G2=Filetage-gaz BSP (cylindrique)							
R=BSP thread (tapered)							
G2=BSP thread (parallel)							
SO 6241-1/8k-1/4	216.0411.044	400	19	29.0	10.0	4.0	3.300

Anwendungsbeispiele:

Exemples d'utilisation:

Sample combinations:

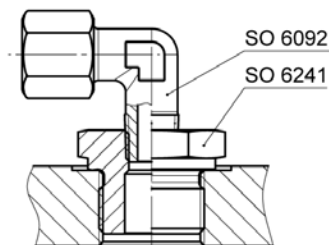

Reduktionsverschraubung

Union de réduction

Reduction union

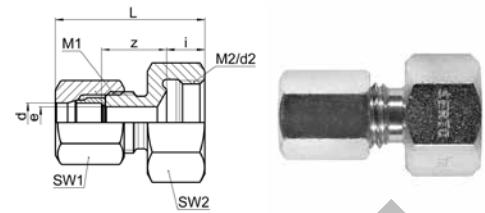
SO 6248

Type -d2 -d	Mat.-Nr.	bar	M1	M2	SW1	SW2	L	i	z	e	kg/100
SO 6248-8-6	218.1203.140	300	12x1.5	14x1.5	14	17	31.0	8.0	15.0	5.2	2.800
SO 6248-10-6	218.1203.175	250	12x1.5	16x1.5	14	19	32.0	9.0	15.0	5.2	3.200
SO 6248-10-8	218.1203.190	250	14x1.5	16x1.5	17	19	32.0	9.0	15.0	6.2	3.900
SO 6248-12-6	218.1203.215	250	12x1.5	18x1.5	14	22	33.0	9.0	16.0	5.2	3.900
SO 6248-12-8	218.1203.225	250	14x1.5	18x1.5	17	22	33.0	9.0	16.0	6.2	4.700
SO 6248-12-10	218.1203.240	250	16x1.5	18x1.5	19	22	36.0	9.0	17.0	8.2	6.100
SO 6248-15-8	218.1203.400	200	14x1.5	22x1.5	17	27	35.0	10.0	16.0	6.2	6.400
SO 6248-15-10	218.1203.410	200	16x1.5	22x1.5	19	27	37.0	10.0	17.0	8.2	7.600
SO 6248-15-12	218.1203.420	200	18x1.5	22x1.5	22	27	39.0	10.0	17.0	10.2	8.400
SO 6248-16-10	218.1203.470	200	16x1.5	24x1.5	19	30	37.0	10.0	17.0	8.2	8.700
SO 6248-16-12	218.1203.480	200	18x1.5	24x1.5	22	30	39.0	10.0	17.0	10.2	10.000
SO 6248-18-8	218.1203.570	200	14x1.5	26x1.5	17	32	34.0	10.0	16.0	6.2	8.400
SO 6248-18-10	218.1203.575	200	16x1.5	26x1.5	19	32	37.0	10.0	17.0	8.0	9.100
SO 6248-18-12	218.1203.580	200	18x1.5	26x1.5	22	32	39.0	10.0	17.0	10.2	10.400
SO 6248-18-14	218.1203.600	200	22x1.5	26x1.5	27	32	41.0	10.0	18.0	12.5	13.700
SO 6248-18-15	218.1203.610	200	22x1.5	26x1.5	27	32	41.0	10.0	18.0	12.5	13.700
SO 6248-22-12	218.1203.730	160	18x1.5	30x2.0	22	36	41.0	11.0	18.0	10.2	12.600
SO 6248-22-14	218.1203.740	160	22x1.5	30x2.0	27	36	42.0	11.0	18.0	12.5	15.300
SO 6248-22-15	218.1203.745	160	22x1.5	30x2.0	27	36	42.0	11.0	18.0	12.5	15.300
SO 6248-22-18	218.1203.755	160	26x1.5	30x2.0	32	36	46.0	11.0	19.0	16.0	19.100

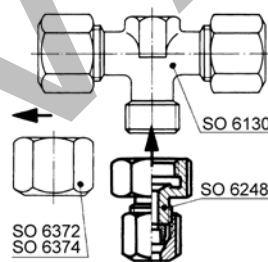
Anwendungsbeispiele:
Exemples d'utilisation:
Sample combinations:

Dichtungsprinzip: Bei der Montage (mit 1/4 Umdrehung) drückt sich die Dichtkante des Übergangsstückes in das SERTO-Formteil ein, dadurch entsteht eine einwandfreie metallische Dichtung. Wir empfehlen, das Gewinde mit einem geeigneten Flüssigklebstoff gegen unbeabsichtigtes Lösen zu sichern.

d = Kenngröße: entspricht dem Rohraussen- \varnothing der Anschlüsse SO 6372 und SO 6374, welche gegen die Reduzierschraubung SO 6248 ausgetauscht werden können.

Principe d'étanchéité: Lors de l'assemblage (avec 1/4 de tour), l'arête d'étanchéité du raccord appuie sur la pièce moulée SERTO, créant ainsi une étanchéité parfaite. Nous recommandons de fixer le filetage avec une colle liquide appropriée pour empêcher le desserrage involontaire.

d = dimension nominale: correspond au dia. extérieur du tube de l'écrou des raccords SO 6372 et SO 6374, lesquels peuvent être échangé contre l'union de réduction SO 6248.

Sealing principle: During assembly (with 1/4 turn), the sealing edge of the reduction union presses into the SERTO moulded part to produce a perfect seal. We recommend that the thread is secured against accidental unscrewing by means of a suitable liquid adhesive.

d = nominal size: corresponds to tube outside dia. of the connections SO 6372 and SO 6374 which can be replaced by the reduction union SO 6248.

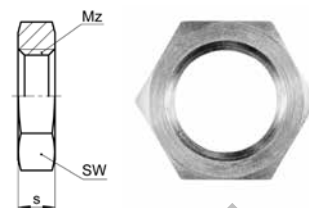
Sechskantmutter METR
Ecrou à six pans METR
Hexagon nut METR

SO 6310 METR

Type-Mz	Mat.-Nr.	SW	s	kg/100
Mz=metrisches Gewinde (zylindrisch)	Mz=Filetage métrique (cylindrique)	Mz=Metric thread (parallel)		
SO 6310-M12x1,5	216.0063.195	17	6.00	0.700
SO 6310-M14x1,5	216.0063.225	19	6.00	0.800
SO 6310-M16x1,5	216.0063.265	22	6.00	1.100
SO 6310-M18x1,5	216.0063.305	24	6.00	1.100
SO 6310-M22x1,5	216.0063.375	30	7.00	2.200
SO 6310-M24x1,5	216.0063.405	32	7.00	2.400
SO 6310-M26x1,5	216.0063.435	36	8.00	3.500
SO 6310-M30x2	216.0063.470	41	8.00	4.500

Sechskantmutter für SO 6093 und SO 6333

Ecrou à six pans pour SO 6093 et SO 6333

Hexagon nut for SO 6093 and SO 6333

Gerade Einschraubverschraubung

mit Dichtkante

Union mâle

avec arête d'étanchéité

Male adaptor union

with edge seal

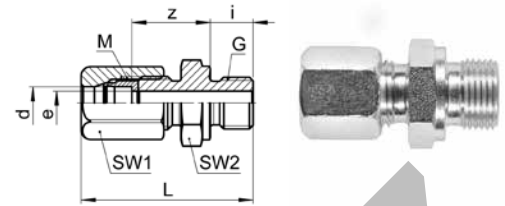

SO 6331

Type -d-G	Mat.-Nr.	bar	M	SW1	SW2	L	D	i	t	z	e	kg/100
G=Rohrgewinde (zylindrisch)	G=Filetage-gaz BSP (cylindrique)			G=BSP thread (parallel)								
SO 6331-6-1/8	218.1141.100	400	12x1.5	14	14	32.5	14.5	8.0	1.0	16.5	4.0	2.500
SO 6331-6-1/4	218.1141.110	400	12x1.5	14	19	38.0	18.5	12.0	1.5	18.0	5.0	3.900
SO 6331-8-1/4	218.1141.170	300	14x1.5	17	19	38.0	18.5	12.0	1.5	18.0	6.0	4.500
SO 6331-10-1/4	218.1141.270	250	16x1.5	19	19	41.0	18.5	12.0	1.5	19.0	7.0	5.800
SO 6331-10-3/8	218.1141.280	250	16x1.5	19	22	42.5	22.5	12.0	2.0	20.5	7.0	7.500
SO 6331-10-1/2	218.1141.285	250	16x1.5	19	27	45.0	27.0	14.0	2.5	21.0	8.0	8.900
SO 6331-12-1/4	218.1141.380	250	18x1.5	22	19	43.0	18.5	12.0	1.5	19.0	7.0	7.250
SO 6331-12-3/8	218.1141.390	250	18x1.5	22	22	44.5	22.5	12.0	2.0	20.5	9.0	8.500
SO 6331-12-1/2	218.1141.400	250	18x1.5	22	27	47.0	27.0	14.0	2.5	21.0	10.0	11.200
SO 6331-14-3/8	218.1141.502	250	22x1.5	27	22	46.5	22.5	12.0	2.0	21.5	9.0	11.800
SO 6331-14-1/2	218.1141.504	250	22x1.5	27	27	49.0	27.0	14.0	2.5	22.0	11.0	13.700
SO 6331-15-3/8	218.1141.532	200	22x1.5	27	22	46.5	22.5	12.0	2.0	21.5	9.0	11.800
SO 6331-15-1/2	218.1141.534	200	22x1.5	27	27	49.0	27.0	14.0	2.5	22.0	11.0	14.200
SO 6331-16-1/2	218.1141.566	200	24x1.5	30	27	52.0	27.0	14.0	2.5	23.0	12.0	17.000
SO 6331-18-3/8	218.1141.644	200	26x1.5	32	32	53.0	22.5	12.0	2.0	25.0	9.0	17.900
SO 6331-18-1/2	218.1141.646	200	26x1.5	32	27	53.0	27.0	14.0	2.5	23.0	14.0	17.900
SO 6331-18-3/4	218.1141.648	200	26x1.5	32	32	56.0	33.0	16.0	2.5	24.0	16.0	21.300
SO 6331-18-1	218.1141.652	200	26x1.5	32	41	58.0	40.0	18.0	2.5	24.0	14.0	29.660
SO 6331-20-1/2	218.1141.706	200	26x1.5	32	27	54.5	27.0	14.0	2.5	23.5	14.0	17.900
SO 6331-20-3/4	218.1141.708	200	26x1.5	32	32	57.5	33.0	16.0	2.5	24.5	16.0	21.600
SO 6331-20-1	218.1141.712	200	26x1.5	32	41	59.5	40.0	18.0	2.5	24.5	14.0	29.880
SO 6331-22-3/4	218.1141.768	160	30x2.0	36	32	56.0	33.0	16.0	2.5	26.0	18.0	24.200
SO 6331-22-1	218.1141.770	160	30x2.0	36	41	59.0	40.0	18.0	2.5	27.0	19.0	33.500
SO 6331-25-1	218.1141.810	160	33x2.0	41	41	64.0	40.0	18.0	2.5	29.0	22.0	40.600
SO 6331-28-1	218.1141.850	160	36x2.0	41	41	61.0	40.0	18.0	2.5	27.0	23.0	33.200
SO 6331-30-1	218.1141.900	160	39x2.0	46	41	68.0	40.0	18.0	2.5	32.0	25.0	44.600
SO 6331-30-1 1/4	218.1141.902	160	39x2.0	46	50	72.0	50.0	20.0	2.5	34.0	27.0	58.500

Gerade Einschraubverschraubung R

mit Dichtkante

Union mâle R

avec arête d'étanchéité

Male adaptor union R

with edge seal

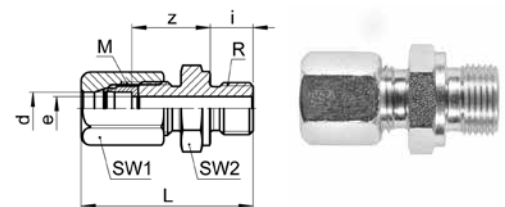

SO 6331 R

Type -d-R	Mat.-Nr.	bar	M	SW1	SW2	L	D	i	t	z	e	kg/100
R=Rohrgewinde (kegelig)	R=Filetage-gaz BSP (conique)			R=BSP thread (tapered)								
SO 6331-8-1/4k	218.1101.160	300	14x1.5	17	14	31.0	17.0	8.0	0.5	18.0	5.2	3.200

Fortsetzung nächste Seite

Suite à la prochaine page

Continued on next page

d=Rohrøussen-ø
e=kleinste Bohrung
L=Mass in montiertem Zustand

d=ø extérieur du tube
e=ø-min. de passage
L=après montage

d=tube outside diameter
e=minimum bore
L=installed length

Gerade Einschraubverschraubung METR

mit Dichtkante

Union mâle METR

avec arête d'étanchéité

Male adaptor union METR

with edge seal

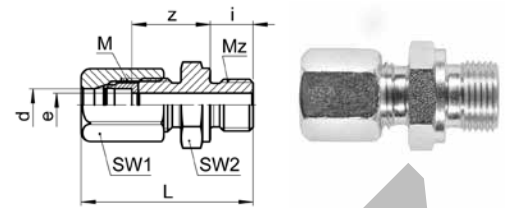

SO 6331 METR

Type -d-Mz	Mat.-Nr.	bar	M	SW1	SW2	L	D	i	t	z	e	kg/100
Mz=metrisches Gewinde (zylindrisch)	Mz=Filetage métrique (cylindrique)	Mz=Metric thread (parallel)										
SO 6331-6-M10x1	218.1143.180	400	12x1.5	14	14	32.5	14.5	8.0	1.0	16.5	4.0	2.600
SO 6331-8-M12x1,5	218.1143.240	300	14x1.5	17	17	38.0	17.5	12.0	1.5	18.0	6.0	4.000
SO 6331-10-M14x1,5	218.1143.280	250	16x1.5	19	19	41.0	19.5	12.0	1.5	19.0	7.0	5.900
SO 6331-12-M16x1,5	218.1143.330	250	18x1.5	22	22	44.5	21.5	12.0	1.5	20.5	9.0	8.300
SO 6331-14-M18x1,5	218.1143.380	250	22x1.5	27	24	46.5	23.5	12.0	2.0	21.5	11.0	12.200
SO 6331-15-M18x1,5	218.1143.390	200	22x1.5	27	24	46.5	23.5	12.0	2.0	21.5	11.0	12.200
SO 6331-16-M22x1,5	218.1143.410	200	24x1.5	30	27	52.0	28.0	14.0	2.5	23.0	12.5	17.500
SO 6331-18-M22x1,5	218.1143.460	200	26x1.5	32	27	53.0	28.0	14.0	2.5	23.0	14.0	18.500
SO 6331-18-M26x1,5	218.1143.465	200	26x1.5	32	32	56.0	32.0	16.0	2.5	24.0	14.0	21.400
SO 6331-20-M22x1,5	218.1143.500	200	26x1.5	32	27	54.5	28.0	14.0	2.5	23.5	14.0	18.500
SO 6331-20-M26x1,5	218.1143.505	200	26x1.5	32	32	57.5	32.0	16.0	2.5	24.5	14.0	21.400
SO 6331-22-M26x1,5	218.1143.535	160	30x2.0	36	32	56.0	32.0	16.0	2.5	26.0	18.0	24.200
SO 6331-25-M33x2	218.1143.550	160	33x2.0	41	41	64.0	40.0	18.0	2.5	29.0	22.0	40.200

Einbauempfehlung:

Conseil de montage:

Recommendation for installation:

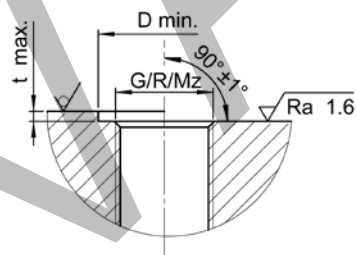

d=Rohrassens-ø
e=kleinste Bohrung
L=Mass in montiertem Zustand

d=ø extérieur du tube
e=ø-min. de passage
L=après montage

d=tube outside diameter
e=minimum bore
L=installed length

Thermofühlerverschraubung

mit Dichtkante und mit Klemmring aus Edelstahl

Union pour sondes thermocouple

avec arête d'étanchéité et avec bague de serrage en acier inoxydable

Temperature probe union

with edge seal and with stainless steel compression ferrule

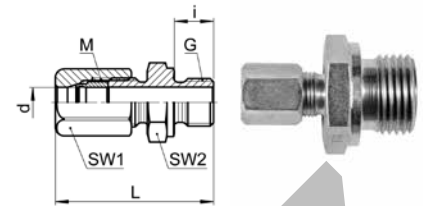

SO 6331-D

Type-d-G	Mat.-Nr.	bar	M	SW1	SW2	L	D	i	t	kg/100
G=Rohrgewinde (zylindrisch)	G=Filetage-gaz BSP (cylindrique)	G=BSP thread (parallel)								
SO 6331-3-1/4 -D	YDD.610.0501	400	6x0.75	8	19	31.0	19.5	12.0	1.5	2.430
SO 6331-6-1/4 -D	YDD.610.0600	200	10x1.0	12	19	37.0	19.5	12.0	1.5	3.240
SO 6331-6-1/2 -D	YDD.610.0603	200	10x1.0	12	27	41.0	28.0	14.0	2.5	7.285
SO 6331-8-1/4 -D	YDD.610.0620	160	12x1.0	14	19	38.5	19.5	12.0	1.5	3.600
SO 6331-8-1/2 -D	YDD.610.0621	160	12x1.0	14	27	42.5	28.0	14.0	2.5	7.000
SO 6331-9-1/2 -D	YDD.610.0640	160	16x1.0	19	27	42.5	27.0	14.0	2.5	9.130
SO 6331-12-1/2 -D	YDD.610.0701	100	16x1.0	19	27	44.5	28.0	14.0	2.5	8.800

Bei kleinen Baugrößen bestehen einzelne Komponenten aus Edelstahl.

Pour les petites tailles, certains composants sont en acier inoxydable.

For small sizes, some components are made of stainless steel.

Thermofühlerverschraubung METR

mit Dichtkante und mit Klemmring aus Edelstahl

Union pour sondes thermocouple METR

avec arête d'étanchéité et avec bague de serrage en acier inoxydable

Temperature probe union METR

with edge seal and with stainless steel compression ferrule

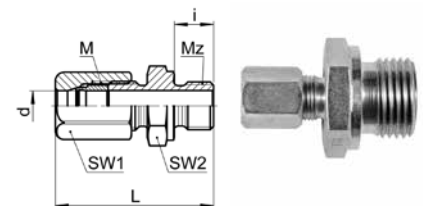

SO 6331-D METR

Type-d-Mz	Mat.-Nr.	bar	M	SW1	SW2	L	D	i	t	kg/100
Mz=metrisches Gewinde (zylindrisch)	Mz=Filetage métrique (cylindrique)	Mz=Metric thread (parallel)								
SO 6331-1-M8x1-D	YDD.610.0400	400	6x0.75	8	12	24.0	12.5	8.0	1.0	1.080
SO 6331-1,5-M8x1-D	YDD.610.0420	400	6x0.75	8	12	24.0	12.5	8.0	1.0	1.080
SO 6331-2-M8x1-D	YDD.610.0460	400	6x0.75	8	12	24.0	12.5	8.0	1.0	1.060
SO 6331-3-M8x1-D	YDD.610.0500	400	6x0.75	8	12	25.5	12.5	8.0	1.0	1.100

Bei kleinen Baugrößen bestehen einzelne Komponenten aus Edelstahl.

Pour les petites tailles, certains composants sont en acier inoxydable.

For small sizes, some components are made of stainless steel.

Fortsetzung nächste Seite

Suite à la prochaine page

Continued on next page

Einbauempfehlung:

Conseil de montage:

Recommendation for installation:

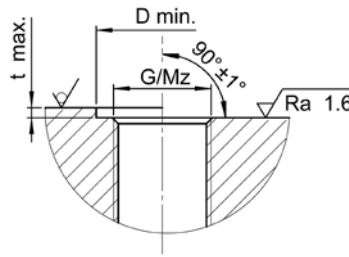

Anwendungsbeispiele:

Exemples d'utilisation:

Sample combinations:

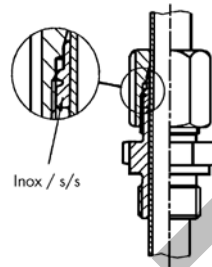

Temperatur bis +200 °C

Der Klemmring presst sich bei der ersten Montage – durch Anziehen der Mutter – auf das Rohr bleibend auf, es entsteht eine metallische Dichtung.

Die Verbindung kann durch Lösen der Mutter demontiert werden, wobei allerdings der Klemmring auf dem Rohr haften bleibt. Es ist also nach der Erstmontage kein Verschieben des Rohres möglich.

Für nachträgliches Verschieben des Klemmrings wird der Einsatz der Thermofühlerverschraubungen mit PTFE-Klemmring SO 61194-D-PTFE empfohlen.

Température jusqu'au +200 °C

Au premier serrage du raccord la bague de serrage étrangle légèrement le tube. Le résultat est une étanchéité métal sur métal.

Par desserrage de l'écrou le raccord peut être démonté. La bague de serrage reste sur le tube. Un déplacement du tube n'est pas possible après le premier montage.

Pour un déplacement ultérieur de la bague de serrage, il est recommandé d'utiliser les unions pour sondes thermocouple avec bague de serrage en PTFE, SO 61194-D-PTFE.

Temperature up to +200 °C

When mounted for the first time, the compression ferrule is pressed onto the tube by tightening the nut. A metal sealing is the result.

The union can be demounted by loosening the nut. However, the compression ferrule remains on the tube. A displacement of the tube is not possible after the first mounting.

For later displacement of the compression ferrule, the use of the temperature probe union with PTFE compression ferrule SO 61194-D-PTFE is recommended.

Thermofühlerverschraubung

mit Dichtkante und mit PTFE-Klemmring

Union pour sondes thermocouple

avec arête d'étanchéité et avec bague de serrage en PTFE

Temperature probe union

with edge seal and with PTFE compression ferrule

SO 61194-D-PTFE

Type-d-G	Mat.-Nr.	bar	M	SW1	SW2	L	D	i	t	kg/100
G=Rohrgewinde (zylindrisch)	G=Filetage-gaz BSP (cylindrique)	G=BSP thread (parallel)								
SO 61194-2-1/4	YDD.610.0042	6	6x0.75	8	19	29.0	18.5	12.0	1.5	2.300
SO 61194-3-1/4	YDD.610.0062	6	6x0.75	8	19	29.0	18.5	12.0	1.5	2.300
SO 61194-4,5-1/4	YDD.610.0092	6	8x1.0	10	19	33.0	18.5	12.0	1.5	2.625
SO 61194-6-1/4	YDD.610.0112	6	10x1.0	12	19	33.5	19.5	12.0	1.5	2.870
SO 61194-6-1/2	YDD.610.0113	6	10x1.0	12	27	37.0	28.0	14.0	2.5	4.600
SO 61194-9-1/2	YDD.610.0130	6	16x1.0	19	27	41.5	27.0	14.0	2.5	8.100

Temperatur/Druck bis +200° C und 6 bar

Bei kleinen Baugrößen bestehen einzelne Komponenten aus Edelstahl.

Température/pression jusqu'au +200° C et 6 bar

Pour les petites tailles, certains composants sont en acier inoxydable.

Temperature/pressure up to +200° C and 6 bar

For small sizes, some components are made of stainless steel.

Thermofühlerverschraubung METR

mit Dichtkante und mit PTFE-Klemmring

Union pour sondes thermocouple METR

avec arête d'étanchéité et avec bague de serrage en PTFE

Temperature probe union METR

with edge seal and with PTFE compression ferrule

SO 61194-D-PTFE METR

Type-d-Mz	Mat.-Nr.	bar	M	SW1	SW2	L	D	i	t	kg/100
Mz=metrisches Gewinde (zylindrisch)	Mz=Filetage métrique (cylindrique)	Mz=Metric thread (parallel)								
SO 61194-0,5 M8x1	YDD.610.0001	6	6x0.75	8	12	23.5	12.5	8.0	1.0	1.030
SO 61194-1 M8x1	YDD.610.0010	6	6x0.75	8	12	23.5	12.5	8.0	1.0	1.030
SO 61194-1,5 M8x1	YDD.610.0020	6	6x0.75	8	12	23.5	12.5	8.0	1.0	1.030
SO 61194-2 M8x1	YDD.610.0040	6	6x0.75	8	12	23.5	12.5	8.0	1.0	1.010
SO 61194-3 M8x1	YDD.610.0060	6	6x0.75	8	12	23.5	12.5	8.0	1.0	1.000
SO 61194-3 M10x1	YDD.610.0061	6	6x0.75	8	14	24.0	14.5	8.0	1.0	1.320
SO 61194-4 M8x1	YDD.610.0080	6	8x1.0	10	12	27.5	12.5	8.0	1.0	1.200
SO 61194-4,5 M8x1	YDD.610.0090	6	8x1.0	10	12	27.5	12.5	8.0	1.0	1.200
SO 61194-6 M10x1	YDD.610.0111	6	10x1.0	12	14	28.5	14.5	8.0	1.0	1.735

Temperatur/Druck bis +200° C und 6 bar

Bei kleinen Baugrößen bestehen einzelne Komponenten aus Edelstahl.

Température/pression jusqu'au +200° C et 6 bar

Pour les petites tailles, certains composants sont en acier inoxydable.

Temperature/pressure up to +200° C and 6 bar

For small sizes, some components are made of stainless steel.

Fortsetzung nächste Seite

Suite à la prochaine page

Continued on next page

d=Rohrassens-ø
e=kleinste Bohrung
L=Mass in montiertem Zustand

d=ø extérieur du tube
e=ø-min. de passage
L=après montage

d=tube outside diameter
e=minimum bore
L=installed length

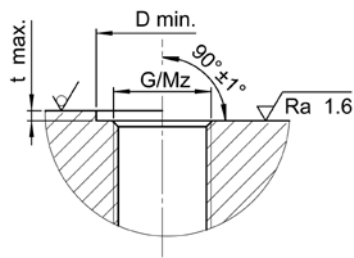
Einbauempfehlung:
Conseil de montage:
Recommendation for installation:

PTFE Klemmring zu SO 51194/SO 61194
Bague de serrage en PTFE pour SO 51194/
SO 61194
PTFE compression ferrule for SO 51194/
SO 61194

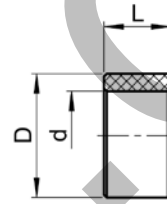
SO 50009

Type-d	Mat.-Nr.	L	D	kg/100
SO 50009-0,5	056.0016.505	2,5	5,0	0,010
SO 50009-1	056.0016.510	2,5	5,0	0,010
SO 50009-1,5	056.0016.515	2,5	5,0	0,010
SO 50009-2	056.0016.520	2,5	5,0	0,010
SO 50009-3	056.0016.530	2,5	5,0	0,010
SO 50009-4	056.0016.540	4,0	6,7	0,010
SO 50009-4,5	056.0016.545	4,0	6,7	0,010
SO 50009-6	056.0016.560	4,5	8,5	0,010
SO 50009-9	056.0016.590	5,5	12,5	0,010

Gerade Aufschraubverschraubung

Union femelle

Female adaptor union

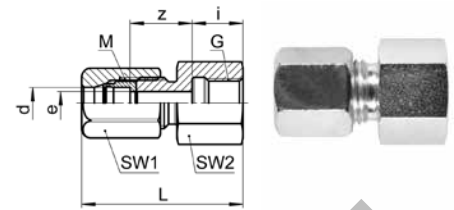

SO 6332

Type -d-G	Mat.-Nr.	bar	M	SW1	SW2	L	i	z	e	kg/100
G=Rohrgewinde (zylindrisch)			G=Filetage-gaz BSP (cylindrique)							
			G=BSP thread (parallel)							
SO 6332-6-1/8	218.1201.100	400	12x1.5	14	14	32.0	10.0	14.0	5.2	2.500
SO 6332-6-1/4	218.1201.110	400	12x1.5	14	19	34.0	11.0	15.0	5.2	4.200
SO 6332-6-3/8	218.1201.120	400	12x1.5	14	22	35.0	12.0	15.0	5.2	4.800
SO 6332-6-1/2	218.1201.125	400	12x1.5	14	27	41.0	14.0	19.0	5.2	8.700
SO 6332-8-1/4	218.1201.170	300	14x1.5	17	19	34.0	11.0	15.0	6.2	4.700
SO 6332-8-1/2	218.1201.185	300	14x1.5	17	27	37.0	14.0	15.0	6.2	6.900
SO 6332-10-1/4	218.1201.270	250	16x1.5	19	19	37.0	11.0	16.0	8.2	6.100
SO 6332-10-3/8	218.1201.280	250	16x1.5	19	22	38.0	12.0	16.0	8.2	6.800
SO 6332-10-1/2	218.1201.285	250	16x1.5	19	27	40.0	14.0	16.0	8.2	8.400
SO 6332-12-1/4	218.1201.380	250	18x1.5	22	19	39.0	11.0	16.0	8.2	7.700
SO 6332-12-3/8	218.1201.390	250	18x1.5	22	22	40.0	12.0	16.0	10.2	7.900
SO 6332-12-1/2	218.1201.400	250	18x1.5	22	27	42.0	14.0	16.0	10.2	9.500
SO 6332-14-1/2	218.1201.504	250	22x1.5	27	27	44.0	14.0	17.0	12.5	13.200
SO 6332-15-1/2	218.1201.534	200	22x1.5	27	27	44.0	14.0	17.0	12.5	13.200
SO 6332-16-1/2	218.1201.566	200	24x1.5	30	27	46.0	14.0	17.0	14.0	15.600
SO 6332-18-1/2	218.1201.646	200	26x1.5	32	27	48.0	14.0	18.0	14.0	17.500
SO 6332-18-3/4	218.1201.648	200	26x1.5	32	32	52.0	17.0	19.0	16.0	19.100
SO 6332-20-1/2	218.1201.706	200	26x1.5	32	27	49.5	14.0	18.5	14.0	17.500
SO 6332-20-3/4	218.1201.708	200	26x1.5	32	32	53.5	17.0	19.5	16.0	19.100
SO 6332-22-3/4	218.1201.768	160	30x2.0	36	32	52.0	17.0	21.0	18.0	23.000
SO 6332-25-1	218.1201.810	160	33x2.0	41	41	60.0	20.0	23.0	22.0	36.900
SO 6332-28-1	218.1201.850	160	36x2.0	41	41	59.0	20.0	23.0	23.0	30.200
SO 6332-30-1	218.1201.900	160	39x2.0	46	41	63.0	20.0	25.0	25.0	35.890

Anwendungsbeispiele:

Exemples d'utilisation:

Sample combinations:

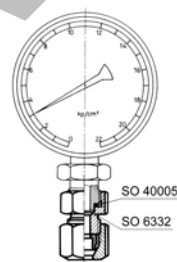

d=Rohrassen-ø
e=kleinste Bohrung
L=Mass in montiertem Zustand

d=ø extérieur du tube
e=ø-min. de passage
L=après montage

d=tube outside diameter
e=minimum bore
L=installed length

Gerade Schottverschraubung

Durchführungslänge max. 20 mm

Union double traversée de cloison

pour cloison max. 20 mm

Panel mount union

max. panel thickness 20 mm

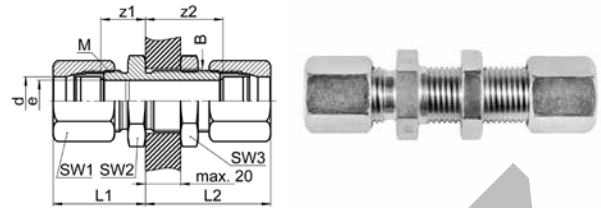

SO 6333

Type -d	Mat.-Nr.	bar	M	SW1	SW2	SW3	L1	L2	B	z1	z2	e	kg/100
SO 6333-6	218.1500.060	400	12x1.5	14	17	17	23.0	43.0	12.5	15.0	35.0	5.0	6.200
SO 6333-8	218.1500.080	300	14x1.5	17	19	19	24.0	43.0	14.5	16.0	35.0	6.2	8.500
SO 6333-10	218.1500.100	250	16x1.5	19	22	22	28.0	46.0	16.5	18.0	36.0	8.2	12.500
SO 6333-12	218.1500.120	250	18x1.5	22	24	24	30.0	49.0	18.5	18.0	37.0	10.2	16.100
SO 6333-14	218.1500.140	250	22x1.5	27	27	30	33.0	52.0	22.5	20.0	39.0	12.5	27.300
SO 6333-15	218.1500.150	200	22x1.5	27	27	30	33.0	52.0	22.5	20.0	39.0	12.5	26.700
SO 6333-16	218.1500.160	200	24x1.5	30	30	32	36.0	54.0	24.5	21.0	39.0	14.0	35.000
SO 6333-18	218.1500.180	200	26x1.5	32	32	36	38.0	58.0	26.5	23.0	42.0	16.0	41.000
SO 6333-20	218.1500.200	200	26x1.5	32	32	36	40.5	59.5	26.5	23.5	42.5	16.0	41.000
SO 6333-22	218.1500.220	160	30x2.0	36	36	41	40.0	58.0	30.5	26.0	44.0	19.0	52.200

Sechskantmutter siehe SO 6310

Ecrou à six pans voir SO 6310

Hexagon nut see SO 6310

Einstellbare Einschraubverschraubung

mit Dichtkante

Union mâle orientable

avec arête d'étanchéité

Adjustable male adaptor union

with edge seal

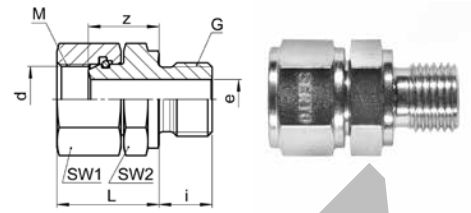

SO 6335

Type -d-G	Mat.-Nr.	bar	M	SW1	SW2	L	D	i	t	z	e	kg/100
G=Rohrgewinde (zylindrisch)	G=Filetage-gaz BSP (cylindrique)			G=BSP thread (parallel)								
SO 6335-6-1/8	218.1651.100	250	12x1.5	14	14	20.0	14.5	8.0	1.0	14.0	4.0	2.000
SO 6335-8-1/4	218.1651.170	250	14x1.5	17	17	22.0	17.5	12.0	1.5	16.0	6.0	3.500
SO 6335-10-1/4	218.1651.270	200	16x1.5	19	19	23.5	18.5	12.0	1.5	16.0	7.0	4.100
SO 6335-12-3/8	218.1651.390	200	18x1.5	22	22	24.0	22.5	12.0	2.0	17.0	9.0	6.000
SO 6335-14-1/2	218.1651.504	160	22x1.5	27	27	28.0	27.0	14.0	2.5	19.0	11.0	10.200
SO 6335-15-1/2	218.1651.534	160	22x1.5	27	27	28.0	27.0	14.0	2.5	19.0	11.0	10.200
SO 6335-16-1/2	218.1651.566	160	24x1.5	30	27	29.0	27.0	14.0	1.5	20.0	12.0	12.100
SO 6335-18-1/2	218.1651.646	160	26x1.5	32	27	29.0	27.0	14.0	1.5	20.0	14.0	12.500
SO 6335-18-3/4	218.1651.648	160	26x1.5	32	32	29.0	33.0	16.0	1.5	20.0	16.0	14.500
SO 6335-20-1/2	218.1651.706	160	26x1.5	32	27	29.0	27.0	14.0	1.5	20.0	14.0	12.500
SO 6335-20-3/4	218.1651.708	160	26x1.5	32	32	29.0	27.0	16.0	1.5	20.0	16.0	14.500
SO 6335-22-3/4	218.1651.768	160	30x2.0	36	36	32.0	33.0	16.0	1.5	22.0	18.0	17.700
SO 6335-25-1	218.1651.810	160	33x2.0	41	41	36.5	40.0	18.0	2.5	24.5	20.0	30.000
SO 6335-28-1	218.1651.850	160	36x2.0	41	41	34.5	40.0	18.0	1.5	24.5	23.0	24.800

Einstellbare Einschraubverschraubung

mit Dichtkante

Union mâle orientable

avec arête d'étanchéité

Adjustable male adaptor union

with edge seal

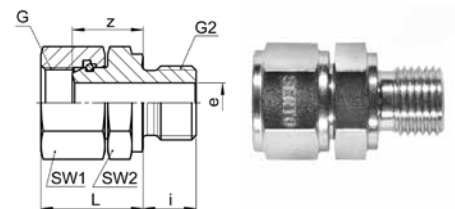

SO 6335 G

Type -G-G2	Mat.-Nr.	bar	SW1	SW2	L	D	i	t	z	e	kg/100	
G=Rohrgewinde (zylindrisch)	G=Filetage-gaz BSP (cylindrique)			G=BSP thread (parallel)								
SO 6335-1/8-1/8	218.1655.042	250	14	14	20.0	14.5	8.0	1.0	14.0	4.0	2.000	
SO 6335-1/4-1/4	218.1655.104	250	17	17	22.0	17.5	12.0	1.5	15.5	6.0	3.500	
SO 6335-3/8-3/8	218.1655.166	200	22	22	24.5	22.5	12.0	2.0	15.5	9.0	6.000	
SO 6335-1/2-1/2	218.1655.228	160	27	27	29.0	27.0	14.0	2.5	19.0	11.0	10.200	

Fortsetzung nächste Seite

Suite à la prochaine page

Continued on next page

Einstellbare Einschraubverschraubung METR

mit Dichtkante

Union mâle orientable METR

avec arête d'étanchéité

Adjustable male adaptor union METR

with edge seal

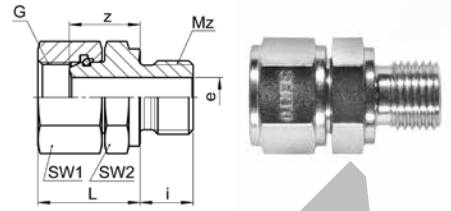

SO 6335 METR

Type -G -Mz	Mat.-Nr.	bar	SW1	SW2	L	D	i	t	z	e	kg/100
G=Rohrgewinde (zylindrisch)											
Mz=metrisches Gewinde (zylindrisch)											
SO 6335-1/4-M10x1	218.1656.040	250	14	14	20.0	14.5	8.0	1.0	14.0	4.0	2.500
SO 6335-1/4-M12x1,5	218.1656.085	250	17	17	22.0	17.5	12.0	1.5	15.5	6.0	3.500
SO 6335-3/4-M16x1,5	218.1656.150	200	22	22	24.0	21.5	12.0	1.5	16.0	9.0	5.500
SO 6335-1/2-M18x1,5	218.1656.180	160	27	24	28.5	23.5	12.0	1.5	18.5	11.0	9.500

Anwendungsbeispiele:

Exemples d'utilisation:

Sample combinations:

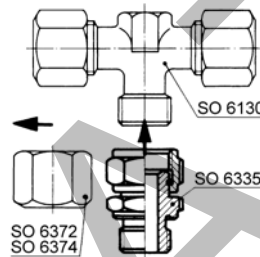

Mit der einstellbaren Einschraubverschraubung lassen sich verschiedene Grundteile einfach verbinden. Kompakte Bauweise, schnelle Montage, einfache Fixierung der Komponenten in der gewünschten Stellung.

L'union orientable mâle permet de connecter facilement différents corps de raccord. Construction compacte, montage rapide, fixation facile des composants dans la position désirée.

With the adjustable male adaptor union different basic components can easily be connected. Compact construction, quick assembly, and easy fixing of the components in the desired position.

d = Kenngröße: entspricht dem Rohraussen-Ø der Anschlüsse SO 6372 und SO 6374, die gegen die einstellbare Einschraubverschraubung SO 6335 ausgetauscht werden können.

d = dimension nominale: correspond au dia. extérieur du tube de l'écrou des raccords SO 6372 et SO 6374, lesquels peuvent être échangé contre l'union mâle orientable SO 6335.

d = nominal size: corresponds to tube outside dia. of the connections SO 6372 and SO 6374 which could be replaced by the adjustable male adaptor union SO 6335.

Montagehinweis: Anschlussmutter mit 1/4 Umdrehung anziehen. Wir empfehlen eine zusätzliche Schmierung auf der Planfläche.

Note d'installation: Serrez l'écrou de 1/4 de tour. Nous recommandons une lubrification supplémentaire sur la surface plane.

Assembly information: Tighten the union nut with 1/4 turn. We recommend additional lubrication on the plane surface.

Einbauempfehlung:

Conseil de montage:

Recommendation for installation:

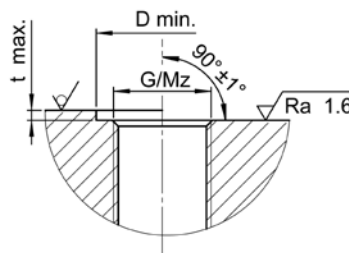

d=Rohraussen-Ø
e=kleinste Bohrung
L=Mass in montiertem Zustand

d=Ø extérieur du tube
e=Ø-min. de passage
L=après montage

d=tube outside diameter
e=minimum bore
L=installed length

Anschweisverschraubung

Union simple avec embout à souder

Weld-on union

SO 6336

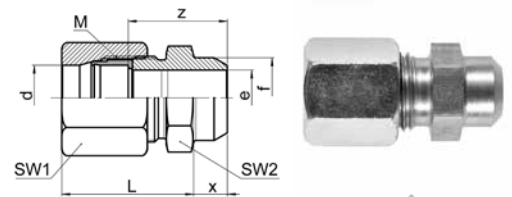

Type -d	Mat.-Nr.	bar	M	SW1	SW2	L	f	x	z	e	kg/100
SO 6336-6	218.1400.060	400	12x1.5	14	12	22.0	10.0	8.0	22.0	4.0	2.300
SO 6336-8	218.1400.080	300	14x1.5	17	14	24.0	12.0	8.0	24.0	6.2	3.400
SO 6336-10	218.1400.100	250	16x1.5	19	17	28.0	14.0	8.0	26.0	8.2	5.100
SO 6336-12	218.1400.120	250	18x1.5	22	19	30.0	16.0	8.0	26.0	10.2	6.700
SO 6336-14	218.1400.140	250	22x1.5	27	22	33.0	19.0	10.0	30.0	12.5	11.300
SO 6336-15	218.1400.150	200	22x1.5	27	22	33.0	19.0	10.0	30.0	12.5	11.300
SO 6336-18	218.1400.180	200	26x1.5	32	27	38.0	22.0	10.0	32.0	15.0	17.300
SO 6336-20	218.1400.200	200	26x1.5	32	27	39.5	22.0	10.0	32.5	15.0	17.300
SO 6336-22	218.1400.220	160	30x2.0	36	32	40.0	27.0	12.0	38.0	19.0	24.200
SO 6336-28	218.1400.280	160	36x2.0	41	41	44.0	32.0	12.0	40.0	24.0	32.200

Nach dem Anschweißen die von SERTO empfohlenen Schmierstellen mit dem Spezial-Schmieröl AC 850 nochmals schmieren.

Après le soudage, graissez les points de lubrification nécessaires, conformément aux recommandations de SERTO, avec l'huile de lubrification spéciale AC 850.

After welding, grease the necessary lubrication points as recommended by SERTO with the special lubrication oil AC 850.

Einstellbare Verschraubung

mit Dichtkante

Union orientable

avec arête d'étanchéité

Adjustable union

with edge seal

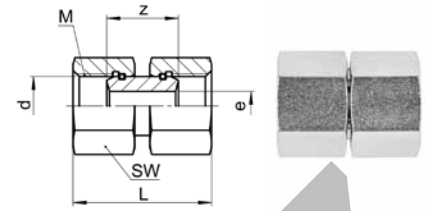

SO 6345

Type -d	Mat.-Nr.	bar	M	SW	L	z	e	kg/100
SO 6345-6	218.1350.060	250	12x1.5	14	27.0	14.5	4.0	1.980
SO 6345-8	218.1350.080	250	14x1.5	17	27.0	14.5	6.0	2.920
SO 6345-10	218.1350.100	200	16x1.5	19	30.0	15.0	7.0	3.820
SO 6345-12	218.1350.120	200	18x1.5	22	31.0	15.0	9.0	5.000
SO 6345-14	218.1350.140	160	22x1.5	27	36.5	18.5	11.0	9.130
SO 6345-15	218.1350.150	160	22x1.5	27	36.5	18.5	11.0	9.130
SO 6345-18	218.1350.180	160	26x1.5	32	36.5	18.5	14.0	13.000
SO 6345-20	218.1350.200	160	26x1.5	32	36.5	18.5	14.0	13.000
SO 6345-22	218.1350.220	160	30x2.0	36	38.5	18.5	18.0	16.100

Einstellbare Verschraubung

mit Dichtkante

Union orientable

avec arête d'étanchéité

Adjustable union

with edge seal

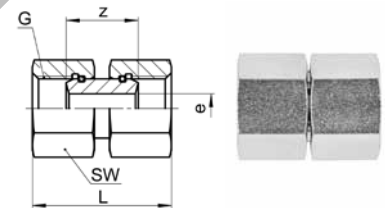

SO 6345 G

Type -G	Mat.-Nr.	bar	SW	L	z	e	kg/100
G=Rohrgewinde (zylindrisch)	G=Filetage-gaz BSP (cylindrique)	G=BSP thread (parallel)					
SO 6345-1/8	218.1361.020	250	14	27.0	14.5	4.0	2.350
SO 6345-1/4	218.1361.040	250	17	27.0	14.5	6.0	3.020
SO 6345-3/8	218.1361.060	200	22	31.0	15.0	9.0	5.320
SO 6345-1/2	218.1361.080	160	27	38.5	18.5	11.0	9.880

Fortsetzung nächste Seite

Suite à la prochaine page

Continued on next page

Einstellbare Verschraubung

mit Dichtkante

Union orientable

avec arête d'étanchéité

Adjustable union

with edge seal

SO 6345 G d

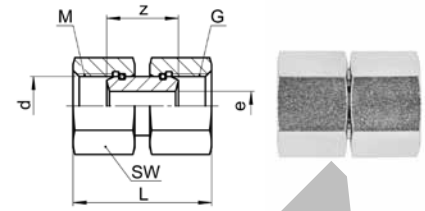

Type-G-d	Mat.-Nr.	bar	M	SW	L	z	e	kg/100
G=Rohrgewinde (zylindrisch)	G=Filetage-gaz BSP (cylindrique)	G=BSP thread (parallel)						
SO 6345-1/8-6	218.1371.100	250	12x1.5	14	27.0	14.5	4.0	2.160
SO 6345-1/4-8	218.1371.220	250	14x1.5	17	27.0	14.5	6.0	2.950
SO 6345-3/8-12	218.1371.340	200	18x1.5	22	31.0	15.0	9.0	5.170
SO 6345-1/2-14	218.1371.380	160	22x1.5	27	36.5	18.5	11.0	9.490
SO 6345-1/2-15	218.1371.400	160	22x1.5	27	36.5	18.5	11.0	9.490

Anwendungsbeispiele:

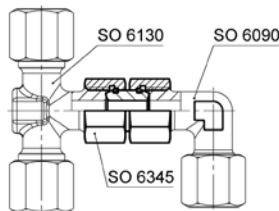

Mit der einstellbaren Verschraubung lassen sich verschiedene Grundteile einfach verbinden. Kompakte Bauweise, schnelle Montage, einfache Fixierung der Komponenten in der gewünschten Stellung.

Beachten Sie auch die Möglichkeiten mit SO 6335.

d = Kenngroße: entspricht dem Rohraussen- \varnothing der Anschlüsse SO 6372 und SO 6374, die gegen die einstellbare Verschraubung SO 6345 ausgetauscht werden können.

Montagehinweis: Beide Anschlussmutter mit 1/4 Umdrehung anziehen. Wir empfehlen eine zusätzliche Schmierung auf der Planfläche.

Exemples d'utilisation:

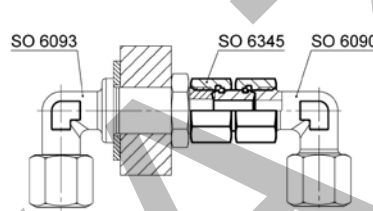

L'union orientable permet de connecter facilement différents corps de raccord. Construction compacte, montage rapide, fixation facile des composants dans la position désirée.

Voir également les possibilités avec SO 6335.

d = dimension nominale: correspond au dia. extérieur du tube de l'écrou de raccords SO 6372 et SO 6374, lesquels peuvent être échangé contre l'union orientable SO 6345..

Note d'installation: Serrez les deux écrous de 1/4 de tour. Nous recommandons une lubrification supplémentaire sur la surface plane.

Sample combinations:

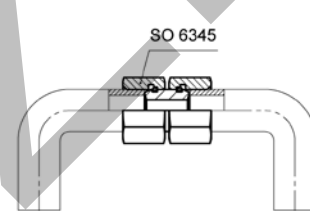

With the adjustable union different basic components can easily be connected. Compact construction, quick assembly, and easy fixing of the components in the desired position.

See SO 6335 for additional possibilities.

d = nominal size: corresponds to tube outside dia. of the connections SO 6372 and SO 6374 which can be replaced by the adjustable union SO 6345.

Assembly information: Tighten both union nuts with 1/4 turn. We recommend additional lubrication on the plane surface.

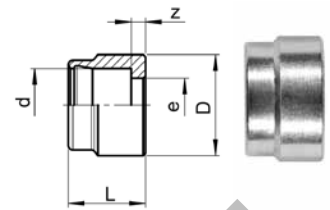
Klemmring
Bague de serrage
Compression ferrule

SO 6372

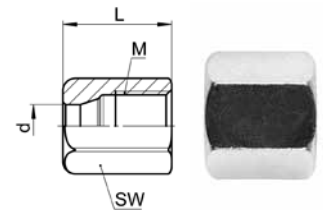
Type -d	Mat.-Nr.	bar	L	D	z	e	kg/100
SO 6372-4	216.0013.040	400	4.3	6.0	1.0	3.0	0.090
SO 6372-6	216.0013.060	400	6.5	8.2	1.0	5.0	0.100
SO 6372-8	216.0013.080	300	7.0	10.2	1.0	7.0	0.140
SO 6372-10	216.0013.100	250	8.0	13.0	1.0	9.0	0.290
SO 6372-12	216.0013.120	250	9.0	15.0	1.0	11.0	0.380
SO 6372-14	216.0013.140	250	10.0	17.0	1.0	13.0	0.520
SO 6372-15	216.0013.150	200	10.0	18.0	1.0	14.0	0.540
SO 6372-16	216.0013.160	200	11.0	19.0	1.0	15.0	0.660
SO 6372-18	216.0013.180	200	12.0	22.0	1.0	17.0	0.880
SO 6372-20	216.0013.200	200	13.0	23.7	1.5	19.0	1.150
SO 6372-22	216.0013.220	160	12.0	26.0	2.0	21.0	1.100
SO 6372-25	216.0013.250	160	13.0	30.0	2.0	24.0	1.820
SO 6372-28	216.0013.280	160	12.0	32.0	2.0	27.0	1.520
SO 6372-30	216.0013.300	160	13.5	35.0	2.0	29.0	2.200

Anschlussmutter
Ecrou
Union nut

SO 6374

Type -d	Mat.-Nr.	bar	M	SW	L	kg/100
SO 6374-6	216.0205.060	400	12x1.5	14	16.0	0.950
SO 6374-8	216.0205.080	300	14x1.5	17	16.0	1.500
SO 6374-10	216.0205.100	250	16x1.5	19	18.0	2.400
SO 6374-12	216.0205.120	250	18x1.5	22	20.0	3.500
SO 6374-14	216.0205.140	250	22x1.5	27	22.0	5.900
SO 6374-15	216.0205.150	200	22x1.5	27	22.0	5.900
SO 6374-16	216.0200.160	200	24x1.5	30	23.0	8.100
SO 6374-18	216.0205.180	200	26x1.5	32	25.0	9.200
SO 6374-20	216.0200.200	200	26x1.5	32	26.0	9.200
SO 6374-22	216.0205.220	160	30x2.0	36	26.0	11.500
SO 6374-25	216.0205.250	160	33x2.0	41	30.0	17.700
SO 6374-28	216.0205.280	160	36x2.0	41	27.0	12.700
SO 6374-30	216.0204.300	160	39x2.0	46	33.0	21.400

Werkstoff:

 Grösse 6 - 28: Stahl SAE 1012
 Grösse 30: Stahl 1.0503

Matériau:

 dimensions 6 - 28: acier SAE 1012
 dimension 30: acier 1.0503

Material:

 sizes 6 - 28: steel SAE 1012
 size 30: steel 1.0503

Anschlussnippel

Ecrou de raccordement mâle

Nipple connection

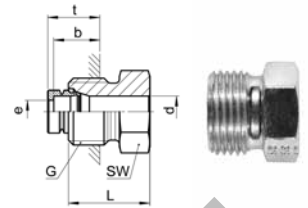

SO 6377

Type -d-G	Mat.-Nr.	bar	SW	L	b	t	e	kg/100
G=Rohrgewinde (zylindrisch)			G=Filetage-gaz BSP (cylindrique)				G=BSP thread (parallel)	
SO 6377-4-1/8	216.0911.045	400	10	16.5	8.5	11.0	3.0	0.700
SO 6377-6-1/4	216.0911.114	400	14	16.5	8.5	11.0	5.0	1.300
SO 6377-8-1/4	216.0911.160	300	14	15.0	8.0	11.0	7.0	1.000
SO 6377-8-3/8	216.0911.182	300	17	17.5	9.0	12.0	7.0	2.000

SO 6377-8-1/4 =
nur für Rohre mit Wandstärke 1 mm

Bitte beachten:
Die jeweils dazugehörenden Klemmringe
SO 6372 müssen separat bestellt werden.

SO 6377-8-1/4 =
seulement pour tubes avec paroi de 1 mm

Remarque:
Les bagues de serrage correspondantes
SO 6372 doivent être commandées séparément.

SO 6377-8-1/4 =
for tubes with wall thickness of 1 mm only

Please note:
The relevant compression ferrules SO 6372
must be ordered separately.

**SO 6611**

Kegelrückschlagventil beidseitig mit
Einschraubgewinde
Clapet anti-retour à siège conique avec
filetage des deux côtés
Taper seat non-return valve with male
adaptor thread at both ends

551**SO 6613**

Kegelrückschlagventil mit
Einschraubgewinde und Rohranschluss
Clapet anti-retour à siège conique avec
filetage et connexion pour tube
Taper seat non-return valve with male
adaptor thread and tube connection

551

KROVAVANZ.COM

Kunststoff PVDF

Verschraubungen









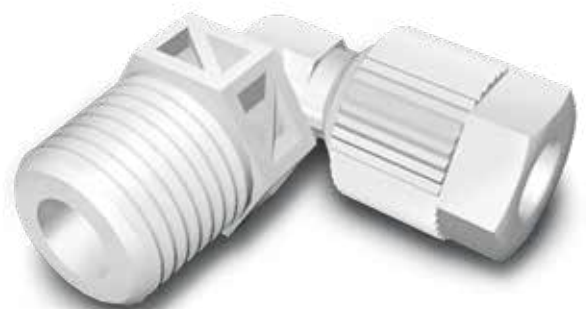

















Plastique PVDF

Raccords

Plastic PVDF

Unions



Seite/Page/Page		Seite/Page/Page		Seite/Page/Page	
388	Klemmring Bague de serrage Compression ferrule 	399-400	Gerade Aufschraubverschraubung Union femelle Female adaptor union 	415	Einstellbare Winkelverschraubung Coude orientable Adjustable elbow union 
SO 20001		SO 21221		SO 22621	
388	Abschlusszapfen Bouchon d'arrêt Plug 	401-402	Verbindungsrippel Pièce folle Tube stub 	416	Winkel-Schottverschraubung Coude traversée de cloison Panel mount elbow union 
SO 20002		SO 21300		SO 22721	
389	Sechskantmutter METR Ecroû à six pans METR Hexagon nut METR 	403	Gerade Schottverschraubung Union double traversée de cloison Panel mount union 	417-418	T-Verschraubung Té égal Tee union 
SO 20006		SO 21521		SO 23021	
389	Anschlussmutter gerändelt Ecroû moleté Union nut knurled 	404	Schott-Einschraubverschraubung Union mâle traversée de cloison Panel mount male adaptor union 	419-420	Einstellbare T- und L-Verschraubung Té et L orientable au centre Adjustable tee and L union 
SO 20020		SO 21524 OR		SO 23621	
390	Übergangsmuffe Adaptateur femelle Female adaptor 	405-409	Einstellnippel Adaptateur orientable mâle Adjustable male adaptor 	421	T-Einschraubverschraubung Té mâle au centre Male adaptor tee union 
SO 20030		SO 21600		SO 23721	
391	Schlauchtülle Douille cannelée Hose nozzle 	410	Reduktions-Einstellverschraubung Raccord de réduction orientable Adjustable reduction union 	Bestätigungen auf www.serto.com Confirmations sur www.serto.com Confirmations on www.serto.com	
SO 20503		SO 21821			
392	Gerade Verschraubung Union double Straight union 	411-412	Winkelverschraubung Coude Elbow union 		
SO 21021		SO 22021			
393-398	Gerade Einschraubverschraubung Union mâle Male adaptor union 	413-414	Winkel-Einschraubverschraubung Coude mâle Male adaptor elbow union 		
SO 21121		SO 22421			

Eigenschaften, Besonderheiten

- einfache, schnelle Montage
- grosse Sortimentsvielfalt
- höchste Chemikalienbeständigkeit

Funktionsprinzip

Siehe Kapitel i

Werkstoff

Polyvinylidenfluorid (PVDF) bietet eine hervorragende Chemikalienbeständigkeit kombiniert mit guten mechanischen und thermomechanischen Eigenschaften. Dieser Werkstoff besticht durch die chemische Beständigkeit gegen eine Vielzahl von aggressiven Medien (s. Beständigkeitsliste im Anhang). Weiter ist das PVDF sehr beständig gegen Sonnenlicht, insbesondere UV-Strahlen.

Brandverhalten: gem. UL94 V0

Betriebsdruck PN

10 bar bei +23 °C (3-fache Sicherheit), höhere Drücke in Kombination mit SERTO Kunststoffrohren auf Anfrage (bar+).

Temperaturbereich

-40 °C bis +100 °C
sterilisierbar bis +121 °C, Material kann sich bei höheren Temperaturen gelblich verfärben

Anzuschliessende Rohre

Toleranzhaltige Rohre und Schläuche mit sauberer Oberfläche und gleichmässiger Wandung. Siehe auch Kapitel i und Kapitel 19.

Kegelige Einschraubgewinde

Zum Abdichten der Einschraubgewinde empfehlen wir das PTFE Band AC 840 oder den Dichtstift «Plasto-Joint» AC 833.

FDA-Konformität

Polyvinylidenfluorid (PVDF) entspricht der CFR* 21, § 177.2510 der FDA (Food and Drug Administration, USA) und kann für den Einsatz im Kontakt mit Lebensmittel verwendet werden. FKM-O-Ringe sind ebenfalls FDA-konform.

*Code of Federal Regulations

Propriétés, spécificités

- montage facile et rapide
- vaste gamme de produits
- excellente résistance chimique

Principe de fonctionnement

Voir chapitre i

Matériau

Le polyfluorure de vinylidène (PVDF) offre une excellente résistance chimique combinée à de bonnes propriétés mécaniques et thermomécaniques. Ce matériau se distingue par sa résistance chimique contre un grand nombre de substances agressives (voir liste des résistances en annexe). Le PVDF est également très résistant à la lumière du soleil, en particulier aux rayons UV.

Inflammabilité: selon UL94 V0

Pression de service PN

10 bar à +23 °C (facteur de sécurité 3), pressions plus élevées en combinaison avec les tubes plastiques SERTO sur demande (bar+).

Plage de température admissible

-40 °C à +100 °C
stérilisable jusqu'à +121 °C, le matériau peut jaunir à des températures plus élevées

Tubes à utiliser

Tubes et tuyaux flexibles respectant les tolérances avec surface propre et d'épaisseur de paroi régulier. Voir aussi chapitre i et chapitre 19.

Filetages mâles coniques

Pour assurer l'étanchéité des filetages mâles, nous recommandons le ruban de PTFE AC 840 ou le bâton «Plasto-Joint» AC 833.

Conformité FDA

Fluorure de polyvinylidène (PVDF) est en conformité avec le CFR* 21, § 177.2510 de la FDA (Food and Drug Administration, USA) et peut être utilisé en contact avec aliments. Les joints toriques sont aussi conformes à la FDA.

*Code of Federal Regulations

Characteristics, specialities

- easy and fast to install
- extensive product range
- high resistance to chemicals

Operating principle

See chapter i

Material

Polyvinylidene fluoride (PVDF) offers excellent chemical resistance combined with good mechanical and thermomechanical properties. This material stands out due to its chemical resistance to a large number of aggressive media (see resistance list in the appendix). The PVDF is also very resistant to sunlight, especially UV rays.

Flammability: according to UL94 V0

Working pressure PN

10 bar at +23 °C (safety factor of 3), higher pressures in combination with SERTO plastic tubes on request (bar+).

Temperature range

-40 °C to +100 °C
sterilizable up to +121 °C, material may turn yellowish at higher temperatures

Tubes to use

Tolerance complying tubes and hoses with clean surface and uniform wall thickness. See also chapter i and chapter 19.

Tapered male threads

For sealing the male threads we recommend the PTFE tape AC 840 or the sealing stick «Plasto-Joint» AC 833.

FDA-Compliance

Polyvinylidene fluoride complies with the CFR* 21, § 177.2510 of FDA (Food and Drug Administration, USA) and can be used in contact with food. FKM-O-rings are also FDA-compliant.

*Code of Federal Regulations

Druckauswertungsgrad in % des PN

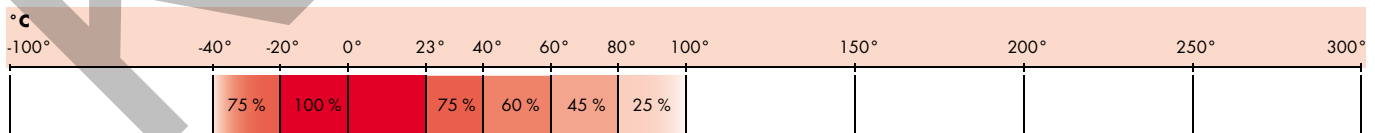

Coefficient de pression de service admissible en % de PN

Pressure coefficient % of PN

Klemmring
Bague de serrage
Compression ferrule

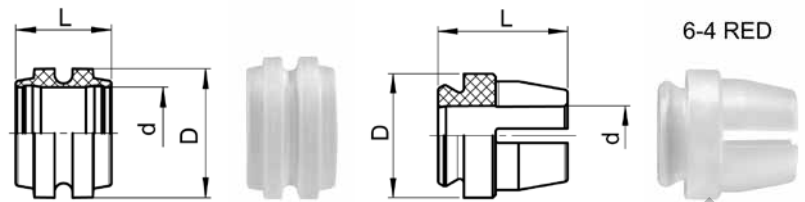

SO 20001

Type -d	Mat.-Nr.	bar +	L	D	kg/100
SO 20001-6-4 RED	126.0014.110	10	9.0	8.6	0.034
SO 20001-6	126.0010.060	10	6.4	8.6	0.019
SO 20001-8	126.0010.080	10	6.4	10.7	0.025
SO 20001-10	126.0010.100	10	6.9	12.7	0.032
SO 20001-12	126.0010.120	10	7.5	14.8	0.043
SO 20001-16	126.0010.160	10	9.4	19.8	0.104

Der Klemmring SO 20001-6-4 RED ist nur in Verbindung mit dem Grundkörper der Grösse 4 verwendbar.

Le bague de serrage SO 20001-6-4 RED est utilisable qu'avec le corps de base de dimension 4.

Compression ferrule SO 20001-6-4 RED can only be used with the base body of size 4.

Abschlusszapfen
Bouchon d'arrêt
Plug

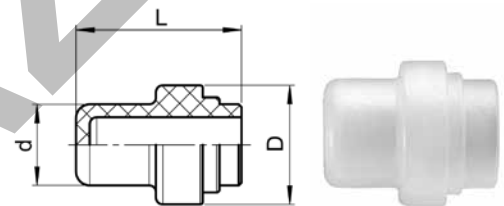

SO 20002

Type -d	Mat.-Nr.	bar +	L	D	kg/100
SO 20002-6	126.0020.060	10	12.0	8.6	0.057
SO 20002-8	126.0020.080	10	12.5	10.6	0.080
SO 20002-10	126.0020.100	10	15.0	12.6	0.122
SO 20002-12	126.0020.120	10	17.0	14.6	0.165
SO 20002-16	126.0020.160	10	22.0	19.7	0.416

Anwendungsbeispiele:

Der Abschlusszapfen lässt sich in jede Verschraubung anstelle eines Klemmringes der gleichen Grösse einsetzen. Wird ein reduzierter Klemmring durch einen Abschlusszapfen ersetzt, so muss immer von der Grösse der Anschlussmutter ausgegangen werden.

Montagehinweis: Anschlussmutter mit 1/2 bis 1 Umdrehung anziehen.

Exemples d'utilisation:

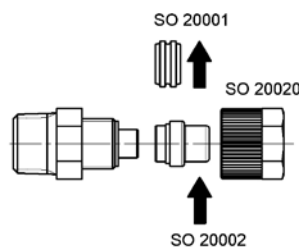

Le bouchon d'arrêt s'insère dans tout raccord au lieu d'une bague de serrage de la même taille. Si une bague de serrage de réduction est remplacée par un bouchon d'arrêt, la taille de l'écrou de raccordement doit toujours être prise en compte.

Note d'installation: Serrez l'écrou d'accouplement de 1/2 - 1 de tour.

Sample combinations:

The plug can be inserted into all unions instead of a compression ferrule of the same size. If a reduction compression ferrule is replaced by a plug, the size of the union nut must be used as a basis.

Assembly information: Tighten the union nut with 1/2 - 1 turn.

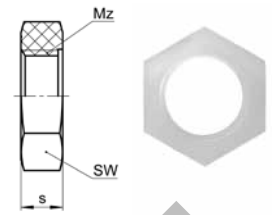
Sechskantmutter METR
Ecrou à six pans METR
Hexagon nut METR

SO 20006 METR

Type -Mz	Mat.-Nr.	SW	s	kg/100
Mz=metrisches Gewinde (zylindrisch)	Mz=Filetage métrique (cylindrique)	Mz=Metric thread (parallel)		
SO 20006-M10x1	126.0063.150	14	4.50	0.085
SO 20006-M12x1	126.0063.190	17	4.50	0.124
SO 20006-M14x1	126.0063.220	19	4.50	0.143
SO 20006-M16x1	126.0063.260	22	5.00	0.214
SO 20006-M22x1,5	126.0063.375	30	5.00	0.380

Sechskantmutter für SO 21521, SO 22721, SO 22724 und Ventile.

Ecrou à six pans pour SO 21521, SO 22721, SO 22724 et vannes.

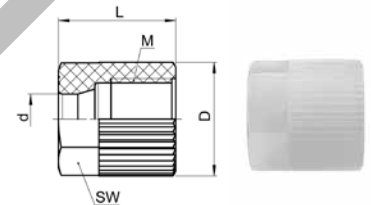
Hexagon nut for SO 21521, SO 22721, SO 22724 and valves.

Anschlussmutter gerändelt
Ecrou moleté
Union nut knurled

SO 20020

Type -d	Mat.-Nr.	bar +	M	SW	L	D	kg/100
SO 20020-6	126.0100.060	10	10x1.0	12	14.5	14.0	0.215
SO 20020-8	126.0100.080	10	12x1.0	14	16.0	16.0	0.276
SO 20020-10	126.0100.100	10	14x1.0	17	17.5	19.5	0.479
SO 20020-12	126.0100.120	10	16x1.0	19	19.5	22.0	0.636
SO 20020-16	126.0100.160	10	22x1.5	24	25.0	27.5	1.166

Übergangsmuffe

Adaptateur femelle

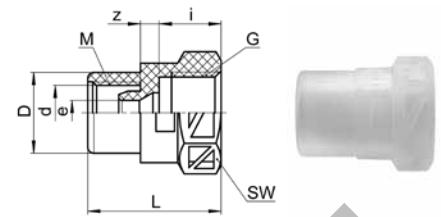
Female adaptor



SO 20030

Type -d-G	Mat.-Nr.	bar +	M	SW	L	D	i	z	e	kg/100
G=Rohrgewinde (zylindrisch)			G=Filetage-gaz BSP (cylindrique)				G=BSP thread (parallel)			
SO 20030-6-1/8	126.0301.100	10	10x1.0	14	20.5	13.0	9.0	3.0	4.0	3.010
SO 20030-6-1/4	126.0301.110	10	10x1.0	17	21.5	13.0	10.0	3.0	4.0	4.210
SO 20030-8-1/4	126.0301.170	10	12x1.0	17	23.0	15.0	10.0	3.0	6.0	4.680
SO 20030-10-1/4	126.0301.270	10	14x1.0	17	23.5	18.0	10.0	3.0	8.0	5.510
SO 20030-10-3/8	126.0301.280	10	14x1.0	22	24.5	18.0	11.0	3.0	8.0	7.730
SO 20030-12-3/8	126.0301.390	10	16x1.0	22	25.5	20.5	11.0	3.0	10.0	8.920
SO 20030-12-1/2	126.0301.400	10	16x1.0	27	29.0	21.0	14.0	3.5	10.0	14.180
SO 20030-16-3/8	126.0301.564	10	22x1.5	22	34.0	26.0	11.0	6.0	13.0	14.150
SO 20030-16-1/2	126.0301.566	10	22x1.5	27	37.5	26.0	14.0	6.5	13.0	18.850
SO 20030-16-3/4	126.0301.568	10	22x1.5	32	39.0	26.0	15.0	7.0	13.0	21.540

Anwendungsbeispiele:

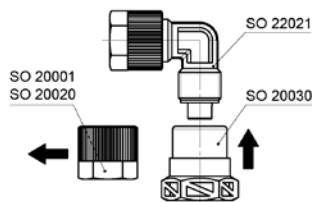

Die Übergangsmuffe kann auf jedes SERTO-Formteil mit dem passenden zylindrischen Gewinde geschraubt werden und muss mit 1/4 Umdrehung angezogen werden.

Dichtungsprinzip: Bei der Montage drückt sich die Dichtkante des Übergangsstückes in das SERTO-Formteil ein, dadurch entsteht eine einwandfreie Dichtung. Wir empfehlen, das Gewinde mit einem geeigneten Flüssigklebstoff gegen unbeabsichtigtes Lösen zu sichern.

Exemples d'utilisation:

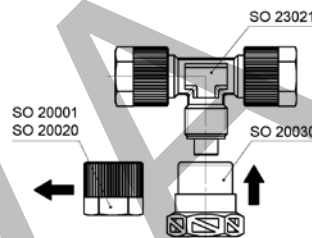

L'adaptateur femelle peut être vissé à toute pièce moulée SERTO avec le filetage cylindrique approprié et doit être serré de 1/4 de tour.

Principe d'étanchéité: Lors de l'assemblage, l'arête d'étanchéité de l'adaptateur appuie sur la pièce moulée SERTO, créant ainsi une étanchéité parfaite. Nous recommandons de fixer le filetage avec une colle liquide appropriée pour empêcher le desserrage involontaire.

Sample combinations:



The female adaptor can be screwed onto all SERTO moulded parts with a matching cylindrical thread and must be tightened with 1/4 turn.

Sealing principle: During assembly, the sealing edge of the female adaptor presses into the SERTO moulded part to produce a perfect seal. We recommend that the thread is secured against accidental unscrewing by means of a suitable liquid adhesive.

Schlauchtülle
Douille cannelée
Hose nozzle

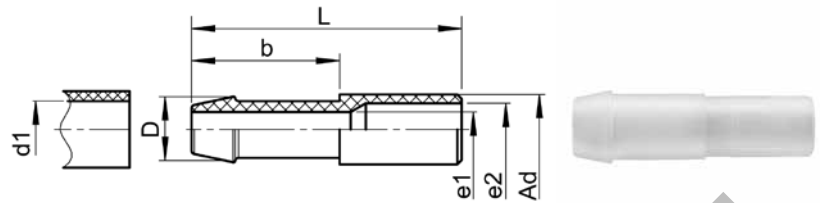

SO 20503

Type -Ad -d1	Mat.-Nr.	bar +	L	D	b	e1	e2	kg/100
SO 20503-A6-4	126.0500.045	10	24.0	5.0	11.0	3.0	4.0	0.050
SO 20503-A6-6	126.0500.060	10	30.0	7.5	17.0	4.0	4.0	0.100
SO 20503-A8-6	126.0500.063	10	31.5	7.5	17.0	4.0	6.0	0.130
SO 20503-A8-8	126.0500.080	10	31.0	9.5	17.0	6.0	6.0	0.140
SO 20503-A10-8	126.0500.083	10	32.0	9.5	17.0	6.0	8.0	0.170
SO 20503-A10-10	126.0500.100	10	34.5	11.5	19.5	7.0	8.0	0.250
SO 20503-A12-10	126.0500.103	10	38.5	11.5	19.5	7.0	10.0	0.290
SO 20503-A12-12	126.0500.120	10	39.5	13.5	19.5	10.0	10.0	0.270

Anwendungsbeispiele:

Exemples d'utilisation:

Sample combinations:

SO 20503

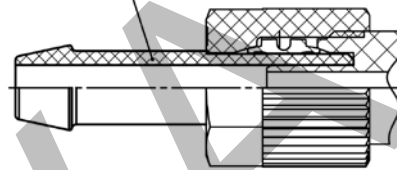

Mit dieser Schlauchtülle können Schläuche und Rohre aus Kunststoff wie z.B. PTFE, PVDF, Polyamid usw. direkt an SERTO-Verschraubungen angeschlossen werden.

Für die Schlauchsicherung verwenden Sie bitte Schlauchklemme SO 40512 (siehe Kapitel 21).

Empfehlung: Für die einfache und korrekte Platzierung des Klemmrings die Montagehilfe AC 870 verwenden.

Avec ce douille cannelée, les tuyaux et les tubes en plastique comme p.exp. PTFE, PVDF, polyamide, etc. peuvent être branchés directement au raccord fileté SERTO.

Pour fixer le tuyau, utilisez le collier de serrage SO 40512 (voir chapitre 21).

Recommendation: Pour un positionnement facile et correct de la bague de serrage, utiliser l'aide au montage AC 870.

With this hose nozzle, hoses and tubes made of plastic, e.g. PTFE, PVDF, polyamide etc. can be connected directly to SERTO unions.

To secure the hose, use the SO 40512 hose clamp (see chapter 21).

Recommendation: For easy and correct placement of the compression ferrule, use the assembly aid AC 870.

Ad=Aussen-ø der Andrehung
d1=Rohrinnendurchmesser
e=kleinste Bohrung

Ad=ø extérieur de la portée cylindrique
d1=ø intérieur du tube
e=ø-min. de passage

Ad=outside diameter of cyl. stub
d1=tube inside diameter
e=minimum bore

Gerade Verschraubung Union double Straight union

SO 21021

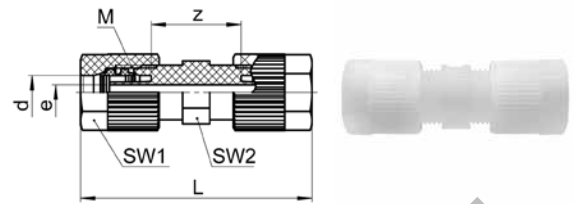

Type-d	Mat.-Nr.	bar +	M	SW1	SW2	L	z	e	kg/100
* SO 21021-4	128.1000.040	10	10x1.0	12	10	41.0	16.5	2.8	0.718
SO 21021-6	128.1000.060	10	10x1.0	12	10	38.5	16.5	2.8	0.730
SO 21021-8	128.1000.080	10	12x1.0	14	12	44.0	18.0	4.8	0.976
SO 21021-10	128.1000.100	10	14x1.0	17	14	45.0	17.5	6.6	1.550
▼ SO 21021-10/7	128.1000.102	10	14x1.0	17	14	45.0	17.5	5.6	1.574
SO 21021-12	128.1000.120	10	16x1.0	19	17	53.0	16.0	8.0	2.105
▼ SO 21021-12/9	128.1000.122	10	16x1.0	19	17	53.0	16.0	7.0	2.126
▼ SO 21021-16/13	128.1000.160	10	22x1.5	24	22	69.0	24.0	11.0	4.445

Gerade Drossel-Verschraubung Union double avec limiteur de débit Straight throttle union

SO 21021 DR

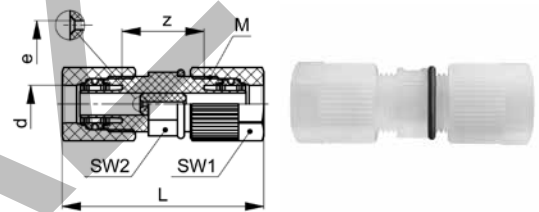

Type-d	Mat.-Nr.	bar +	M	SW1	SW2	L	z	e	kg/100
SO 21021-8 DR 0.6	128.1025.176	10	12x1.0	14	12	44.0	18.0	0.6	1.100

Mit Drosselbohrung 1 mm und eingeführtem 0.8 mm Edelstahl-Draht.

Avec trou d'étranglement de 1 mm et fil en acier inoxydable de 0.8 mm inséré.

With throttle hole 1 mm and inserted 0.8 mm stainless steel wire.

Einseitig markiert mit schwarzem POM-O-Ring.

Marqué sur un côté avec un joint torique en POM noir.

Marked on one side with black POM O-ring.

d=Rohrussen- \varnothing / mit Wandung 1 mm
e=kleinste Bohrung
L=Mass in montiertem Zustand
▼=für Rohre mit Wandung 1,5 mm
*=mit reduziertem Klemmring

d= \varnothing extérieur du tube / avec paroi de 1 mm
e= \varnothing -min. de passage
L=après montage
▼=pour tubes avec paroi de 1,5 mm d'épaisseur
*=avec bague de serrage de réduction

d=tube outside diameter / with wall thickness 1 mm
e=minimum bore
L=installed length
▼=for tubes with wall thickness of 1,5 mm
*=with reduction compression ferrule

Gerade Einschraubverschraubung

Union mâle

Male adaptor union

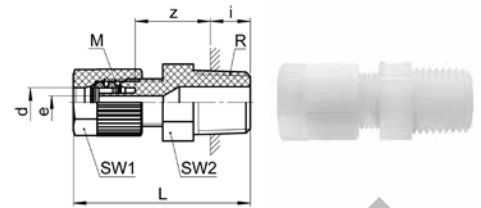

SO 21121

Type -d-R	Mat.-Nr.	bar +	M	SW1	SW2	L	i	z	e	kg/100
R=Rohrgewinde (kegelig)	R=Filetage-gaz BSP (conique)									
R=BSP thread (tapered)										
★ SO 21121-4-1/8	128.1101.060	10	10x1.0	12	12	31.0	5.0	14.0	3.1	0.452
★ SO 21121-4-1/4	128.1101.065	10	10x1.0	12	14	37.0	8.0	16.5	3.1	0.702
★ SO 21121-4-3/8	128.1101.068	10	10x1.0	12	17	37.0	8.0	16.5	2.8	0.948
★ SO 21121-4-1/2	128.1101.070	10	10x1.0	12	22	42.0	10.0	19.5	2.8	1.480
SO 21121-6-1/8	128.1101.100	10	10x1.0	12	12	30.0	5.0	14.0	2.8	0.256
SO 21121-6-1/4	128.1101.110	10	10x1.0	12	14	35.5	8.0	16.5	2.8	0.281
SO 21121-6-3/8	128.1101.120	10	10x1.0	12	17	36.0	8.0	17.0	2.8	0.458
SO 21121-6-1/2	128.1101.125	10	10x1.0	12	22	41.0	10.0	20.0	2.8	1.486
SO 21121-8-1/8	128.1101.160	10	12x1.0	14	12	32.0	5.0	14.0	4.8	0.576
SO 21121-8-1/4	128.1101.170	10	12x1.0	14	14	37.5	8.0	16.5	4.8	0.815
SO 21121-8-3/8	128.1101.180	10	12x1.0	14	17	38.0	8.0	17.0	4.8	1.061
SO 21121-8-1/2	128.1101.185	10	12x1.0	14	22	43.0	10.0	20.0	4.8	1.595
SO 21121-10-1/4	128.1101.270	10	14x1.0	17	14	38.0	8.0	16.0	6.6	1.063
SO 21121-10-3/8	128.1101.280	10	14x1.0	17	17	39.0	8.0	17.0	6.5	1.370
SO 21121-10-1/2	128.1101.285	10	14x1.0	17	22	43.5	10.0	19.5	6.6	1.818
▼ SO 21121-10-7-1/4	128.1101.320	10	14x1.0	17	14	38.5	8.0	16.5	5.6	1.074
▼ SO 21121-10-7-3/8	128.1101.330	10	14x1.0	17	17	38.5	8.0	16.5	5.6	1.319
▼ SO 21121-10-7-1/2	128.1101.335	10	14x1.0	17	22	43.5	10.0	19.5	5.6	1.824
SO 21121-12-1/4	128.1101.380	10	16x1.0	19	14	42.0	8.0	15.5	6.7	0.646
SO 21121-12-3/8	128.1101.390	10	16x1.0	19	17	42.0	8.0	15.5	8.0	0.885
SO 21121-12-1/2	128.1101.400	10	16x1.0	19	22	47.0	10.0	18.5	8.0	1.414
▼ SO 21121-12-9-1/4	128.1101.410	10	16x1.0	19	14	42.0	8.0	15.5	6.7	0.660
▼ SO 21121-12-9-3/8	128.1101.412	10	16x1.0	19	17	42.0	8.0	15.5	7.0	0.905
▼ SO 21121-12-9-1/2	128.1101.414	10	16x1.0	19	22	47.0	10.0	18.5	7.0	1.420
▼ SO 21121-16-13-3/8	128.1101.564	10	22x1.5	24	17	49.5	8.0	19.0	8.0	1.399
▼ SO 21121-16-13-1/2	128.1101.566	10	22x1.5	24	22	54.5	10.0	22.0	11.0	1.988
▼ SO 21121-16-13-3/4	128.1101.568	10	22x1.5	24	27	56.0	12.0	21.5	11.0	2.563

d=Rohrussen-ø / mit Wandung 1 mm
 e=kleinste Bohrung
 L=Mass in montiertem Zustand
 ▼=für Rohre mit Wandung 1,5 mm
 *=mit reduziertem Klemmring

d=ø extérieur du tube / avec paroi de 1 mm
 e=ø-min. de passage
 L=après montage
 ▼=pour tubes avec paroi de 1,5 mm d'épaisseur
 *=avec bague de serrage de réduction

d=tube outside diameter / with wall thickness 1 mm
 e=minimum bore
 L=installed length
 ▼=for tubes with wall thickness of 1,5 mm
 *=with reduction compression ferrule

Gerade Einschraubverschraubung NPT
Union mâle NPT
Male adaptor union NPT

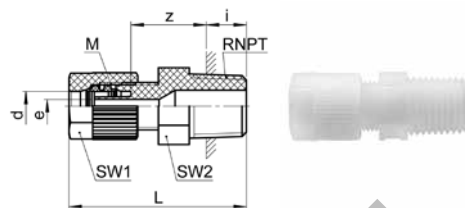
SO 21121 NPT

Type -d -RNPT	Mat.-Nr.	bar +	M	SW1	SW2	L	i	z	e	kg/100
RNPT=NPT Gewinde			RNPT=Filetage NPT							
										RNPT=NPT thread
* SO 21121-4-1/8 NPT	128.1102.060	10	10x1.0	12	11	33.0	7.0	14.0	2.8	0.487
* SO 21121-4-1/4 NPT	128.1102.065	10	10x1.0	12	14	39.0	10.0	16.5	2.8	0.687
SO 21121-6-1/8 NPT	128.1102.100	10	10x1.0	12	11	32.0	7.0	14.0	2.8	0.493
SO 21121-6-1/4 NPT	128.1102.110	10	10x1.0	12	14	37.5	10.0	16.5	2.8	0.693
SO 21121-8-1/8 NPT	128.1102.160	10	12x1.0	14	11	34.0	7.0	14.0	4.8	0.603
SO 21121-8-1/4 NPT	128.1102.170	10	12x1.0	14	14	39.5	10.0	16.5	4.8	0.804
SO 21121-10-1/4 NPT	128.1102.270	10	14x1.0	17	14	40.5	10.0	16.5	6.6	1.055
SO 21121-10-3/8 NPT	128.1102.280	10	14x1.0	17	17	40.5	10.0	16.5	6.6	1.294
▼ SO 21121-10-7-1/4 NPT	128.1102.320	10	14x1.0	17	14	41.0	10.0	17.0	5.6	1.064
▼ SO 21121-10-7-3/8 NPT	128.1102.330	10	14x1.0	17	17	40.5	10.0	16.5	5.6	1.301
▼ SO 21121-12-9-3/8 NPT	128.1102.412	10	16x1.0	19	17	44.0	10.0	15.5	7.0	1.537

d=Rohrussen-ø / mit Wandung 1 mm
 e=kleinste Bohrung
 L=Mass in montiertem Zustand
 ▼=für Rohre mit Wandung 1,5 mm
 *=mit reduziertem Klemmring

d=ø extérieur du tube / avec paroi de 1 mm
 e=ø-min. de passage
 L=après montage
 ▼=pour tubes avec paroi de 1,5 mm d'épaisseur
 *=avec bague de serrage de réduction

d=tube outside diameter / with wall thickness 1 mm
 e=minimum bore
 L=installed length
 ▼=for tubes with wall thickness of 1,5 mm
 *=with reduction compression ferrule

Gerade Einschraubverschraubung

mit Dichtkante

Union mâle

avec arête d'étanchéité

Male adapter union

with edge seal

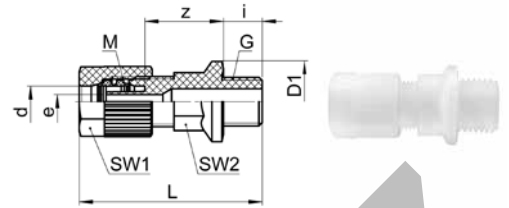

SO 21124

Type -d-G	Mat.-Nr.	bar +	M	SW1	SW2	L	D1	D2	i	t	z	e	kg/100
G=Rohrgewinde (zylindrisch)	G=Filetage-gaz BSP (cylindrique)	G=BSP thread (parallel)											
* SO 21124-4-1/8	128.1161.060	10	10x1.0	12	10	35.0	15.5	16.0	8.0	3.5	15.5	2.8	0.571
* SO 21124-4-1/4	128.1161.065	10	10x1.0	12	13	38.0	19.0	19.5	10.0	3.5	15.5	3.1	0.740
* SO 21124-4-3/8	128.1161.068	10	10x1.0	12	17	39.0	23.5	24.0	10.0	4.0	16.5	2.8	1.055
* SO 21124-4-1/2	128.1161.070	10	10x1.0	12	19	43.0	29.5	30.5	12.0	6.0	19.0	2.8	1.535
SO 21124-6-1/8	128.1161.100	10	10x1.0	12	10	34.0	15.5	16.0	7.5	3.5	15.5	2.8	0.577
SO 21124-6-1/4	128.1161.110	10	10x1.0	12	13	36.5	19.0	19.5	10.0	3.5	15.5	2.8	0.746
SO 21124-6-3/8	128.1161.120	10	10x1.0	12	17	37.0	23.5	24.0	10.0	4.0	16.5	2.8	1.061
SO 21124-6-1/2	128.1161.125	10	10x1.0	12	19	41.5	29.5	30.5	12.0	6.0	19.0	2.8	1.541
SO 21124-8-1/8	128.1161.160	10	12x1.0	14	10	36.0	16.0	16.5	8.0	3.5	15.0	4.8	0.690
SO 21124-8-1/4	128.1161.170	10	12x1.0	14	13	37.5	19.0	19.5	10.0	3.5	15.0	4.8	0.846
SO 21124-8-3/8	128.1161.180	10	12x1.0	14	17	38.5	23.0	23.5	9.5	4.0	16.0	4.8	1.170
SO 21124-8-1/2	128.1161.185	10	12x1.0	14	19	43.5	29.5	30.5	12.0	6.0	19.0	4.8	1.654
SO 21124-10-1/4	128.1161.270	10	14x1.0	17	13	38.5	19.0	19.5	10.0	3.5	14.5	6.6	1.097
SO 21124-10-3/8	128.1161.280	10	14x1.0	17	17	39.5	23.0	23.5	9.5	4.0	16.0	6.6	1.398
SO 21124-10-1/2	128.1161.285	10	14x1.0	17	19	45.0	30.0	31.0	12.0	6.0	19.0	6.6	1.908
SO 21124-12-1/4	128.1161.380	10	16x1.0	19	13	42.5	19.0	19.5	10.0	3.5	14.0	8.0	1.317
SO 21124-12-3/8	128.1161.390	10	16x1.0	19	17	43.0	23.0	23.5	10.0	4.0	14.5	8.0	1.632
SO 21124-12-1/2	128.1161.400	10	16x1.0	19	19	48.0	29.5	30.5	12.0	6.0	17.5	8.0	2.137
▼ SO 21124-12/9-1/4	128.1161.410	10	16x1.0	19	13	42.5	19.0	19.5	10.0	3.5	14.0	7.0	1.360
▼ SO 21124-12/9-3/8	128.1161.412	10	16x1.0	19	17	43.5	23.5	24.0	10.0	4.0	15.0	7.0	1.640
▼ SO 21124-12/9-1/2	128.1161.414	10	16x1.0	19	19	48.5	29.5	30.5	12.0	6.0	18.0	7.0	2.140

Einbauempfehlung:

Conseil de montage:

Recommendation for installation:

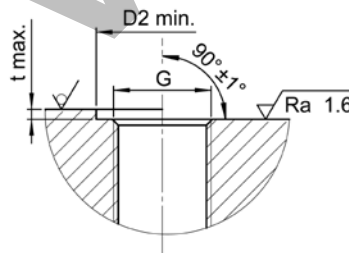

d=Rohrussen-ø / mit Wandung 1 mm
 e=kleinste Bohrung
 L=Mass in montiertem Zustand
 ▼=für Rohre mit Wandung 1,5 mm
 *=mit reduziertem Klemmring

d=ø extérieur du tube / avec paroi de 1 mm
 e=ø-min. de passage
 L=après montage
 ▼=pour tubes avec paroi de 1,5 mm d'épaisseur
 *=avec bague de serrage de réduction

d=tube outside diameter / with wall thickness 1 mm
 e=minimum bore
 L=installed length
 ▼=for tubes with wall thickness of 1,5 mm
 *=with reduction compression ferrule

Gerade Einschraubverschraubung

mit O-Ringabdichtung (FKM)

Union mâle

avec joint torique (FKM)

Male adapter union

with O-Ring seal (FKM)

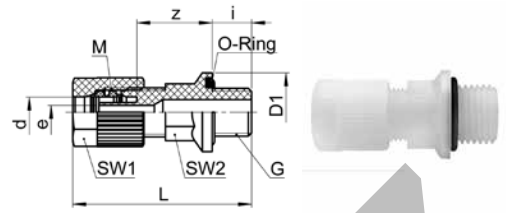

SO 21124 OR

Type -d-G	Mat.-Nr.	bar +	M	SW1	SW2	L	D1	D2	i	t	O-Ring	z	e	kg/100
G=Rohrgewinde (zylindrisch)														
G=Filetage-gaz BSP (cylindrique)														
G=BSP thread (parallel)														
★ SO 21124-4-1/8 OR	128.1171.060	10	10x1.0	12	10	36.0	16.0	16.5	8.0	3.5	9.25x1.78	15.5	3.1	0.576
★ SO 21124-4-1/4 OR	128.1171.065	10	10x1.0	12	13	37.0	19.5	20.0	10.0	3.5	12.42x1.78	15.0	2.8	0.739
★ SO 21124-4-3/8 OR	128.1171.068	10	10x1.0	12	17	39.0	23.5	24.0	10.0	3.5	15.6x1.78	16.5	2.8	1.045
★ SO 21124-4-1/2 OR	128.1171.070	10	10x1.0	12	19	43.0	29.5	30.5	12.0	5.5	20.29x2.62	19.0	2.8	1.516
SO 21124-6-1/8 OR	128.1171.100	10	10x1.0	12	10	34.0	16.0	16.5	8.0	3.5	9.25x1.78	15.0	2.8	0.583
SO 21124-6-1/4 OR	128.1171.110	10	10x1.0	12	13	36.0	19.5	20.0	10.0	3.5	12.42x1.78	15.0	2.8	0.746
SO 21124-6-3/8 OR	128.1171.120	10	10x1.0	12	17	37.5	23.5	24.0	10.0	3.5	15.6x1.78	16.5	2.8	1.051
SO 21124-6-1/2 OR	128.1171.125	10	10x1.0	12	19	42.0	29.5	30.5	12.0	5.5	20.29x2.62	19.0	2.8	1.522
SO 21124-8-1/8 OR	128.1171.160	10	12x1.0	14	10	36.0	16.0	16.5	8.0	3.5	9.25x1.78	15.0	4.7	0.661
SO 21124-8-1/4 OR	128.1171.170	10	12x1.0	14	13	38.0	19.5	20.0	10.0	3.5	12.42x1.78	15.0	4.8	0.661
SO 21124-8-3/8 OR	128.1171.180	10	12x1.0	14	17	39.0	23.5	24.0	10.0	3.5	15.6x1.78	16.0	4.8	1.126
SO 21124-8-1/2 OR	128.1171.185	10	12x1.0	14	19	44.0	30.0	31.0	12.0	5.5	20.29x2.62	19.0	4.8	1.558
SO 21124-10-1/4 OR	128.1171.270	10	14x1.0	17	13	38.5	19.5	20.0	10.0	3.5	12.42x1.78	14.5	6.6	1.072
SO 21124-10-3/8 OR	128.1171.280	10	14x1.0	17	17	39.5	23.5	24.0	10.0	3.5	15.6x1.78	15.5	6.6	1.364
SO 21124-10-1/2 OR	128.1171.285	10	14x1.0	17	19	44.5	29.5	30.5	12.0	5.5	20.29x2.62	18.5	6.6	1.812
SO 21124-12-1/4 OR	128.1171.380	10	16x1.0	19	13	42.5	19.5	20.0	10.0	3.5	12.42x1.78	14.0	8.0	1.289
SO 21124-12-3/8 OR	128.1171.390	10	16x1.0	19	17	43.5	23.5	24.0	10.0	3.5	15.6x1.78	15.0	8.0	1.594
SO 21124-12-1/2 OR	128.1171.400	10	16x1.0	19	19	48.0	29.5	30.5	12.0	5.5	20.29x2.62	17.5	8.0	2.039
▼ SO 21124-129-1/4 OR	128.1171.410	10	16x1.0	19	13	42.5	19.5	20.0	10.0	3.5	12.42x1.78	14.0	7.0	1.334
▼ SO 21124-129-3/8 OR	128.1171.412	10	16x1.0	19	17	43.0	23.0	23.5	10.0	3.5	15.6x1.78	14.5	7.0	1.599
▼ SO 21124-129-1/2 OR	128.1171.414	10	16x1.0	19	19	48.0	29.5	30.5	12.0	5.5	20.29x2.62	18.0	7.0	1.989

Einbauempfehlung:

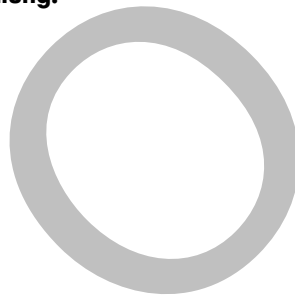

Conseil de montage:

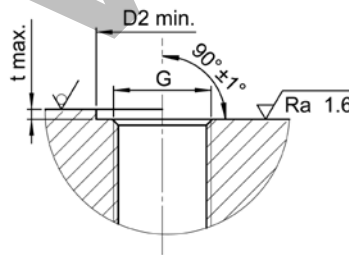

Recommendation for installation:

Einsatztemperaturbereich: -20° C bis +100° C

Die Vorteile dieser O-Ringabdichtung:

- keine Dichtmittelreste in Geräten
- einwandfreie Abdichtung
- keine Beschädigung von Geräten durch konische Gewinde
- schnelle Montage

Plage de température de service: -20° C à +100° C

Les avantages de cette étanchéité à joint torique:

- aucun reste de scellant dans les équipements
- une étanchéité parfaite
- aucun endommagement de l'équipement par le filetage conique
- facilité d'installation

Operating temperature range: -20° C to +100° C

Advantages of this O-ring seal:

- no sealing residues in devices
- perfect seal
- no damage to devices due to tapered thread
- rapid assembly

d=Rohrussen-ø / mit Wandung 1 mm

e=kleinste Bohrung

L=Mass in montiertem Zustand

▼=für Rohre mit Wandung 1,5 mm

*=mit reduziertem Klemmring

d=ø extérieur du tube / avec paroi de 1 mm

e=ø-min. de passage

L=après montage

▼=pour tubes avec paroi de 1,5 mm d'épaisseur

*=avec bague de serrage de réduction

d=tube outside diameter / with wall thickness 1 mm

e=minimum bore

L=installed length

▼=for tubes with wall thickness of 1,5 mm

*=with reduction compression ferrule

Gerade Einschraubverschraubung METR

mit O-Ringabdichtung (FKM)

Union mâle METR

avec joint torique (FKM)

Male adapter union METR

with O-Ring seal (FKM)

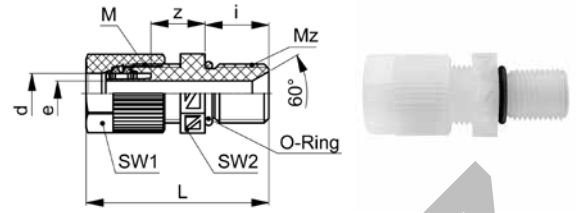

SO 21124 OR METR

Type -d -Mz	Mat.-Nr.	bar +	M	SW1	SW2	L	D	i	t	O-Ring	z	e	kg/100
Mz=metrisches Gewinde (zylindrisch)	Mz=Filetage métrique (cylindrique)	Mz=Metric thread (parallel)											
SO 21124-8-M10x1 OR	128.1173.230	10	12x1.0	14	14	37.0	17.0	13.0	1.0	8.0x1.5	11.0	5.1	0.700
SO 21124-8-M12x1 OR	128.1173.235	10	12x1.0	14	14	37.0	17.0	13.0	1.0	10.0x1.5	11.0	5.1	0.800

Einbauempfehlung:

Conseil de montage:

Recommendation for installation:

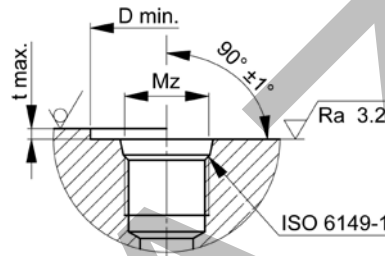

Einsatztemperaturbereich: -20°C bis +100°C

Plage de température de service: -20°C à +100°C

Operating temperature range: -20°C to +100°C

Gerade Einschraubverschraubung UNJF

mit O-Ringabdichtung (FKM)

Union mâle UNJF

avec joint torique (FKM)

Male adapter union UNJF

with O-Ring seal (FKM)

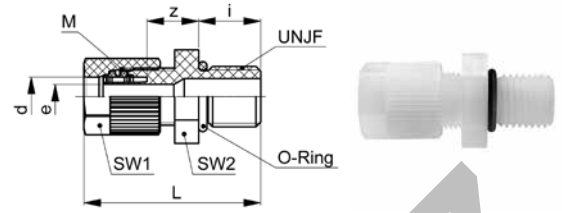

SO 21124 OR UNJF

Type -d-UNJF	Mat.-Nr.	bar +	M	SW1	SW2	L	D	i	t	O-Ring	z	e	kg/100
UNJF=Feingewinde (zylindrisch)			UNJF=Filetage fin (cylindrique)										
UNJF=Fine thread (parallel)													
SO 21124-8-7/16 UNJF OR	128.1178.182	10	12x1.0	14	17	37.0	21.0	13.0	1.0	9.25x1.78	11.0	5.1	0.800
SO 21124-8-1/2 UNJF OR	128.1178.185	10	12x1.0	14	17	37.0	21.0	13.0	1.0	11.1x1.78	11.0	5.1	0.800
SO 21124-8-3/8 UNJF OR	128.1178.189	10	12x1.0	14	17	37.0	21.0	13.0	1.0	12.42x1.78	11.0	5.1	0.800

Einbauempfehlung:

Conseil de montage:

Recommendation for installation:

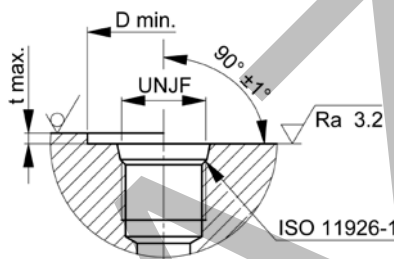

Einsatztemperaturbereich: -20°C bis +100°C

Plage de température de service: -20°C à +100°C

Operating temperature range: -20°C to +100°C

Gerade Aufschraubverschraubung

Union femelle

Female adaptor union

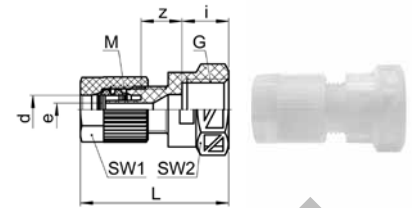
SO 21221

Type -d-G	Mat.-Nr.	bar +	M	SW1	SW2	L	i	z	e	kg/100
G=Rohrgewinde (zylindrisch)	G=Filetage-gaz BSP (cylindrique)	G=BSP thread (parallel)								
* SO 21221-4-1/8	128.1201.060	10	10x1.0	12	14	30.0	9.0	9.0	2.8	0.506
* SO 21221-4-1/4	128.1201.065	10	10x1.0	12	17	31.0	10.0	8.5	2.8	0.618
* SO 21221-4-3/8	128.1201.068	10	10x1.0	12	22	32.0	11.0	9.0	2.8	0.853
* SO 21221-4-1/2	128.1201.070	10	10x1.0	12	27	36.0	14.0	9.5	2.8	1.392
SO 21221-6-1/8	128.1201.100	10	10x1.0	12	14	29.0	9.0	9.0	2.8	0.484
SO 21221-6-1/4	128.1201.110	10	10x1.0	12	17	29.5	10.0	8.5	2.8	0.594
SO 21221-6-3/8	128.1201.120	10	10x1.0	12	22	31.0	11.0	9.0	2.8	0.824
SO 21221-6-1/2	128.1201.125	10	10x1.0	12	27	34.5	14.0	9.5	2.8	1.354
SO 21221-8-1/8	128.1201.160	10	12x1.0	14	14	31.0	9.0	9.0	4.8	0.710
SO 21221-8-1/4	128.1201.170	10	12x1.0	14	17	31.5	10.0	8.5	4.8	0.709
SO 21221-8-3/8	128.1201.180	10	12x1.0	14	22	33.0	11.0	9.0	4.8	0.919
SO 21221-8-1/2	128.1201.185	10	12x1.0	14	27	36.5	14.0	9.5	4.8	1.469
SO 21221-10-1/4	128.1201.270	10	14x1.0	17	17	32.0	10.0	8.0	6.6	0.943
SO 21221-10-3/8	128.1201.280	10	14x1.0	17	22	33.5	11.0	8.5	6.6	1.163
SO 21221-10-1/2	128.1201.285	10	14x1.0	17	27	37.0	14.0	9.0	6.6	1.683
▼ SO 21221-10-7-1/4	128.1201.320	10	14x1.0	17	17	32.5	10.0	8.5	5.6	0.963
▼ SO 21221-10-7-3/8	128.1201.330	10	14x1.0	17	22	33.5	11.0	8.5	5.6	1.183
▼ SO 21221-10-7-1/2	128.1201.335	10	14x1.0	17	27	37.0	14.0	9.0	5.6	1.713
SO 21221-12-3/8	128.1201.390	10	16x1.0	19	22	37.0	11.0	7.5	8.0	1.383
SO 21221-12-1/2	128.1201.400	10	16x1.0	19	27	40.5	14.0	8.0	8.0	1.933
▼ SO 21221-12-9-3/8	128.1201.412	10	16x1.0	19	22	37.0	11.0	7.5	7.0	1.423
▼ SO 21221-12-9-1/2	128.1201.414	10	16x1.0	19	27	40.5	14.0	8.0	7.0	1.963
▼ SO 21221-16/13-3/8	128.1201.564	10	22x1.5	24	22	44.5	11.0	11.0	11.0	1.374
▼ SO 21221-16/13-1/2	128.1201.566	10	22x1.5	24	27	48.0	14.0	11.5	11.0	2.884

d=Rohrussen-ø / mit Wandung 1 mm
 e=kleinste Bohrung
 L=Mass in montiertem Zustand
 ▼=für Rohre mit Wandung 1,5 mm
 *=mit reduziertem Klemmring

d=ø extérieur du tube / avec paroi de 1 mm
 e=ø-min. de passage
 L=après montage
 ▼=pour tubes avec paroi de 1,5 mm d'épaisseur
 *=avec bague de serrage de réduction

d=tube outside diameter / with wall thickness 1 mm
 e=minimum bore
 L=installed length
 ▼=for tubes with wall thickness of 1,5 mm
 *=with reduction compression ferrule

Gerade Aufschraubverschraubung METR
Union femelle METR
Female adaptor union METR

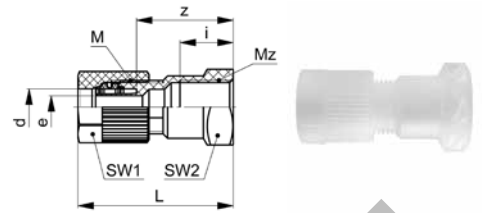

SO 21221 METR

Type -d -Mz	Mat.-Nr.	bar +	M	SW1	SW2	L	i	z	e	kg/100
Mz=metrisches Gewinde (zylindrisch)	Mz=Filetage métrique (cylindrique)	Mz=Metric thread (parallel)								
SO 21221-8-M10x1	128.1204.230	10	12x1.0	14	17	35.0	12.0	22.0	5.1	0.800
SO 21221-8-M12x1	128.1204.235	10	12x1.0	14	17	35.0	12.0	22.0	5.1	0.700

Gerade Aufschraubverschraubung UNJF
Union femelle UNJF
Female adaptor union UNJF

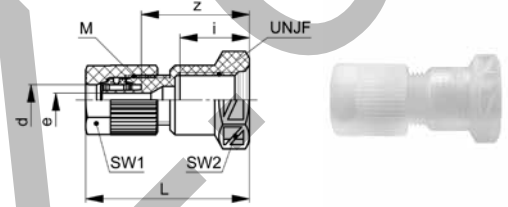

SO 21221 UNJF

Type -d -UNJF	Mat.-Nr.	bar +	M	SW1	SW2	L	i	z	e	kg/100
UNJF=Feingewinde (zylindrisch)	UNJF=Filetage fin (cylindrique)	UNJF=Fine thread (parallel)								
SO 21221-8-7/16 UNJF	128.1205.182	10	12x1.0	14	17	35.0	14.0	22.0	4.8	0.700
SO 21221-8-3/8 UNJF	128.1205.189	10	12x1.0	14	22	35.0	14.0	23.0	4.8	1.000

d=Rohrussen-ø / mit Wandung 1 mm
 e=kleinste Bohrung
 L=dimensione raccordo montato

d=ø extérieur du tube / avec paroi de 1 mm
 e=ø-min. de passage
 L=après montage

d=tube outside diameter / with wall thickness 1 mm
 e=minimum bore
 L=installed length

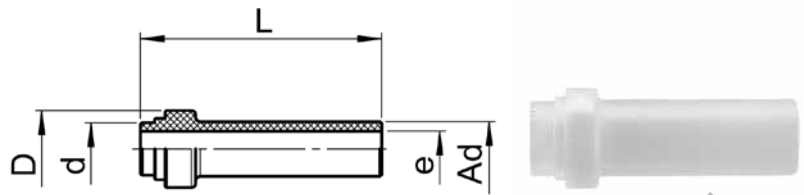
Verbindungsrippel
Pièce folle
Tube stub
SO 21300

Type -d -Ad	Mat.-Nr.	bar +	L	D	e	kg/100
SO 21300-6-A6	126.1300.060	10	27.0	8.6	4.0	0.089
SO 21300-8-A8	126.1300.080	10	28.0	10.6	6.0	0.134
SO 21300-10-A10	126.1300.100	10	33.0	12.6	8.0	0.200
SO 21300-12-A12	126.1300.120	10	37.0	14.6	10.0	0.268
▼ SO 21300-12/9-A12/9	126.1300.122	10	37.0	14.6	9.0	0.366
▼ SO 21300-16/13-A16/13	126.1300.160	10	47.5	19.7	13.0	0.673

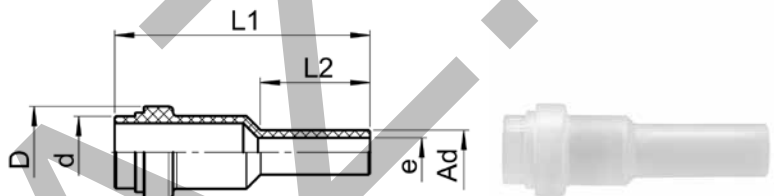
Verbindungsrippel reduziert
Pièce folle réduite
Tube stub reduced
SO 21300 RED

Type -d -Ad	Mat.-Nr.	bar +	L1	L2	D	e	kg/100
SO 21300-6-A4 RED	126.1304.110	10	29.0	15.0	8.6	2.0	0.083
SO 21300-8-A6 RED	126.1304.140	10	30.0	15.0	10.6	4.0	0.125
SO 21300-10-A6 RED	126.1304.175	10	35.0	15.0	12.6	4.0	0.177
SO 21300-10-A8 RED	126.1304.190	10	35.0	15.0	12.6	6.0	0.194
SO 21300-12-A8 RED	126.1304.225	10	39.0	19.0	14.6	6.0	0.239
SO 21300-12-A10 RED	126.1304.240	10	39.0	19.0	14.6	8.0	0.260
▼ SO 21300-12/9-A10 RED	126.1304.272	10	39.0	19.0	14.6	8.0	0.312
▼ SO 21300-16/13-A12 RED	126.1304.480	10	50.0	25.0	19.7	10.0	0.556

Fortsetzung nächste Seite

Suite à la prochaine page

Continued on next page

d=Rohrassen- \varnothing / mit Wandung 1 mm
 Ad=Aussen- \varnothing der Andrehung
 e=kleinste Bohrung
 ▼=für Rohre mit Wandung 1,5 mm

d= \varnothing extérieur du tube / avec paroi de 1 mm
 Ad= \varnothing extérieur de la portée cylindrique
 e= \varnothing -min. de passage
 ▼=pour tubes avec paroi de 1,5 mm d'épaisseur

d=tube outside diameter / with wall thickness 1 mm
 Ad=outside diameter of cyl. stub
 e=minimum bore
 ▼=for tubes with wall thickness of 1,5 mm

Anwendungsbeispiele:

Werden die Verbindungsrippel mit einer Anschlussmutter und einem Armaturenanschluss (Anschlussmutter und Klemmring) verbunden, ergibt dies eine einstellbare Verschraubung.

Montagehinweis: Auf Seite des angedrehten Klemmrings (links im Bild) Anschlussmutter mit 1/4 Umdrehung anziehen. Auf Seite des Armaturenanschlusses (rechts im Bild) Anschlussmutter mit 1 3/4 Umdrehung anziehen.

Empfehlung: Für die einfache und korrekte Platzierung des Klemmrings die Montagehilfe AC 870 verwenden.

Exemples d'utilisation:

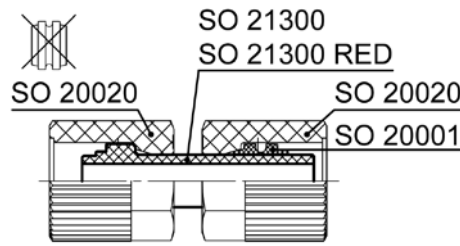

Si l'insert de la pièce folle est relié à un écrou et à un écrou de raccordement (écrou et bague de serrage), cela fournit une union orientable.

Note d'installation: Serrez l'écrou sur le côté de la bague de serrage tournée (à gauche sur l'illustr.) de 1/4 de tour. Serrez l'écrou de l'autre côté (à droite sur l'illustr.) de 1 3/4 tour.

Recommendation: Pour un positionnement facile et correct de la bague de serrage, utiliser l'aide au montage AC 870.

Sample combinations:

If the tube stubs are coupled with a union nut and a nut connection (union nut and compression ferrule), an adjustable union is produced.

Assembly information: Tighten the union nut on the side of the turned compression ferrule (left in pict.) with 1/4 turn. Tighten the union nut on the other side (right in pict.) 1 3/4 turns.

Recommendation: For easy and correct placement of the compression ferrule, use the assembly aid AC 870.

Anwendungsbeispiele:

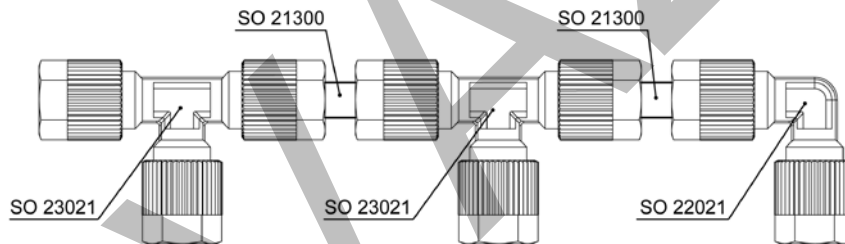

Exemples d'utilisation:

Mit der einstellbaren Verschraubung lassen sich Formteile mit dem gleichen Anschlussgewinde verbinden.

Avec l'union orientable, il est possible de connecter des raccords de même filetages.

Sample combinations:

With the adjustable union, parts with the same connecting thread can be connected.

d=Rohrussen-ø / mit Wandung 1 mm
Ad=Aussen-ø der Andrehung
e=kleinste Bohrung
▼=für Rohre mit Wandung 1,5 mm

d=ø extérieur du tube / avec paroi de 1 mm
Ad=ø extérieur de la portée cylindrique
e=ø-min. de passage
▼=pour tubes avec paroi de 1,5 mm d'épaisseur

d=tube outside diameter / with wall thickness 1 mm
Ad=outside diameter of cyl. stub
e=minimum bore
▼=for tubes with wall thickness of 1,5 mm

Gerade Schottverschraubung

Durchführungslänge max. 6 mm

Union double traversée de cloison

pour cloison max. 6 mm

Panel mount union

max. panel thickness 6 mm

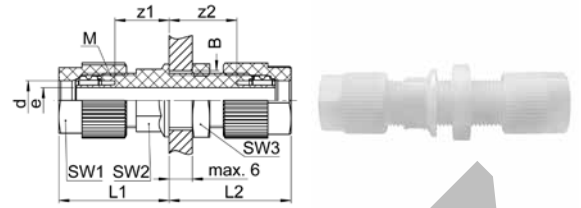

SO 21521

Type-d	Mat.-Nr.	bar +	M	SW1	SW2	SW3	L1	L2	B	z1	z2	e	kg/100
* SO 21521-4	128.1500.040	10	10x1.0	12	14	14	25.0	29.0	10.5	13.0	17.0	3.1	0.979
SO 21521-6	128.1500.060	10	10x1.0	12	14	14	24.0	28.0	10.5	13.0	17.0	2.8	0.991
SO 21521-8	128.1500.080	10	12x1.0	14	12	17	27.0	31.0	12.5	14.0	18.0	4.8	1.344
SO 21521-10	128.1500.100	10	14x1.0	17	14	19	28.0	31.5	14.5	14.0	17.5	6.6	2.007
▼ SO 21521-10/7	128.1500.102	10	14x1.0	17	14	19	28.0	31.5	14.5	14.0	17.5	5.6	2.054
SO 21521-12	128.1500.120	10	16x1.0	19	17	22	33.0	38.0	16.5	14.5	19.5	8.0	2.812
▼ SO 21521-12/9	128.1500.122	10	16x1.0	19	17	22	32.5	38.0	16.5	14.0	19.5	7.0	2.870
▼ SO 21521-16/13	128.1500.160	10	22x1.5	24	22	30	41.0	51.0	22.5	18.0	28.0	11.0	4.634

Sechskantmutter siehe SO 20006

Ecrou à six pans voir SO 20006

Hexagon nut see SO 20006

KONVAV

d=Rohrussen-ø / mit Wandung 1 mm
 e=kleinste Bohrung
 L=Mass in montiertem Zustand
 *=mit reduziertem Klemmring
 ▼=für Rohre mit Wandung 1,5 mm

d=ø extérieur du tube / avec paroi de 1 mm
 e=ø-min. de passage
 L=après montage
 *=avec bague de serrage de réduction
 ▼=pour tubes avec paroi de 1,5 mm d'épaisseur

d=tube outside diameter / with wall thickness 1 mm
 e=minimum bore
 L=installed length
 *=with reduction compression ferrule
 ▼=for tubes with wall thickness of 1,5 mm

Schott-Einschraubverschraubung

mit O-Ringabdichtung (FKM), Durchführungslänge max. 6 mm

Union mâle traversée de cloison

avec joint torique (FKM), pour cloison max. 6 mm

Panel mount male adaptor union

with O-ring seal (FKM), max. panel thickness 6 mm

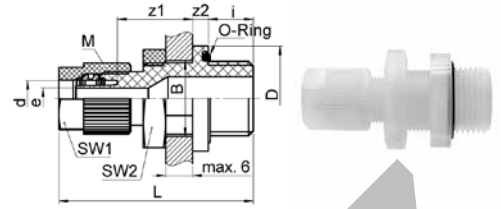

SO 21524 OR

Type -d-G	Mat.-Nr.	bar +	M	SW1	SW2	L	D	B	i	O-Ring	z1	z2	e	kg/100
G=Rohrgewinde (zylindrisch)														
G=Filetage-gaz BSP (cylindrique)														
G=BSP thread (parallel)														
SO 21524-6-3/8 OR	128.1571.120	10	10x1.0	12	22	43.0	23.5	16.5	10.0	15.6x1.78	17.0	5.0	2.8	1.300
SO 21524-8-3/8 OR	128.1571.180	10	12x1.0	14	22	45.0	23.5	16.5	10.0	15.6x1.78	17.0	5.0	4.8	1.400

Anwendungsbeispiele:

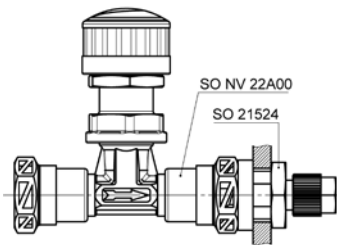

Die Schott-Einschraubverschraubung eignet sich als kompakte Schott-Einbaulösung für z.B. Schalttafeleinbau, Probe-Entnahmestellen, etc.

Sie kann im Regulierventil SO NV 22A00 sowie dem Absperrhahn SO BV 28A00 direkt eingeschraubt werden. Bei Verwendung mit einem Rückschlagventil SO NV 23B21 müssen für eine korrekte Verbindung Mutter/Klemmring gegen die Übergangsmuffe SO 20030 ausgetauscht werden.

Exemples d'utilisation:

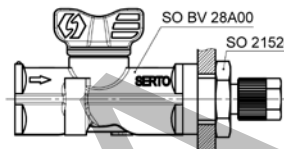

L'union mâle traversée de cloison convient comme solution compacte de montage en cloison, par exemple pour le montage sur panneau, les points d'extraction d'échantillons, etc.

Il peut être vissé directement dans la vanne de réglage SO NV 22A00 ou la vanne à boisseau SO BV 28A00. En cas d'utilisation avec un clapet anti-retour SO NV 23B21, l'écrou/la bague de serrage doivent être remplacé par l'adaptateur femelle SO 20030 pour un raccordement correct.

Sample combinations:

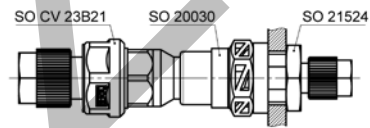

The panel mount male adaptor union is suitable as a compact bulkhead mounting solution, e.g. for panel mounting, sample extraction points, etc.

It can be screwed directly into the regulating valve SO NV 22A00 and the stopcock SO BV 28A00. When used with a non-return valve SO NV 23B21, the nut/clamping ring must be replaced with the female adaptor SO 20030 for a correct connection.

d=Rohrussen-ø / mit Wandung 1 mm
e=kleinste Bohrung
L=Mass in montiertem Zustand

d=ø extérieur du tube / avec paroi de 1 mm
e=ø-min. de passage
L=après montage

d=tube outside diameter / with wall thickness 1 mm
e=minimum bore
L=installed length

Einstellnippel

Adaptateur orientable mâle

Adjustable male adaptor

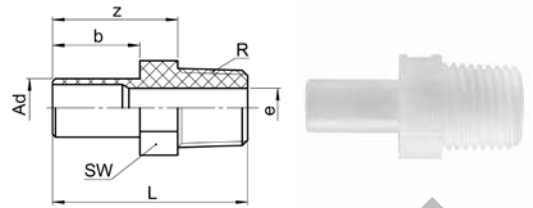

SO 21600

Type -Ad -R	Mat.-Nr.	bar +	SW	L	b	z	e	kg/100
R=Rohrgewinde (kegelig)			R=Filetage-gaz BSP (conique)				R=BSP thread (tapered)	
SO 21600-A6-1/8	126.1601.100	10	12	26.5	13.0	18.0	4.0	0.173
SO 21600-A6-1/4	126.1601.110	10	14	32.0	13.0	19.5	4.0	0.420
SO 21600-A6-3/8	126.1601.120	10	17	32.0	13.0	20.0	4.0	0.650
SO 21600-A6-1/2	126.1601.125	10	22	37.0	13.0	21.0	4.0	1.190
SO 21600-A8-1/8	126.1601.160	10	12	28.0	14.5	19.5	5.0	0.198
SO 21600-A8-1/4	126.1601.170	10	14	32.5	14.0	20.5	6.0	0.444
SO 21600-A8-3/8	126.1601.180	10	17	33.0	14.0	21.0	6.0	0.672
SO 21600-A8-1/2	126.1601.185	10	22	38.0	14.0	22.0	6.0	1.200
SO 21600-A10-1/4	126.1601.270	10	14	33.5	15.0	21.5	6.7	0.451
SO 21600-A10-3/8	126.1601.280	10	17	34.0	15.0	22.0	6.5	0.692
SO 21600-A10-1/2	126.1601.285	10	22	39.0	15.0	23.0	8.0	1.200
SO 21600-A12-1/4	126.1601.380	10	14	37.5	19.0	25.5	6.7	0.506
SO 21600-A12-3/8	126.1601.390	10	17	38.0	19.0	26.0	8.0	0.725
SO 21600-A12-1/2	126.1601.400	10	22	43.0	19.0	27.0	8.5	1.251
SO 21600-A16-3/8	126.1601.564	10	17	44.0	25.0	32.0	8.0	0.957
SO 21600-A16-1/2	126.1601.566	10	22	49.0	25.0	33.0	13.0	1.299
SO 21600-A16-3/4	126.1601.568	10	27	50.5	25.0	34.0	11.0	2.119

Empfehlung: Für die einfache und korrekte Platzierung des Klemmrings die Montagehilfe AC 870 verwenden.

Recommendation: Pour un positionnement facile et correct de la bague de serrage, utiliser l'aide au montage AC 870.

Recommendation: For easy and correct placement of the compression ferrule, use the assembly aid AC 870.

Anwendungsbeispiele:

Exemples d'utilisation:

Sample combinations:

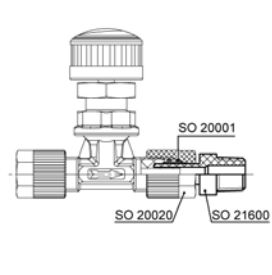
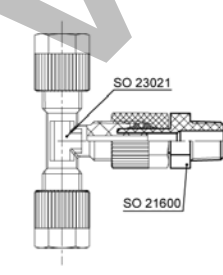
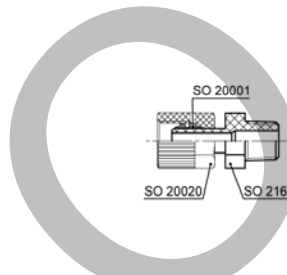

Mögliche Kombinationen:

- mit Armaturenanschluss zu einstellbaren Anschlüssen
- mit Verschraubungen/Ventilen zu einstellbaren Verschraubungen/Ventilen

Combinaisons possibles:

- avec écrou de raccordement ça donne des raccords orientables
- avec raccords/vannes ça donne des raccords/vannes orientables

Possible combinations:

- with nut connection to adjustable connections
- with unions/valves to adjustable unions/valves

Einstellnippel

mit Dichtkante

Adaptateur orientable mâle

avec arête d'étanchéité

Adjustable male adaptor

with edge seal

SO 21624

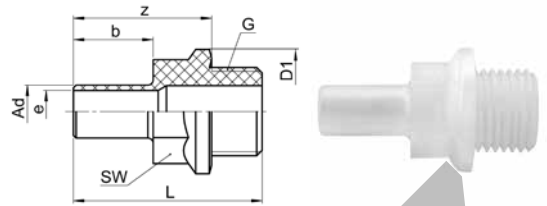

Type -Ad -G	Mat.-Nr.	bar +	SW	L	D1	D2	b	t	z	e	kg/100
G=Rohrgewinde (zylindrisch)	G=Filetage-gaz BSP (cylindrique)		G=BSP thread (parallel)								
SO 21624-A6-1/8	126.1661.100	10	10	30.5	16.0	16.5	13.0	3.5	22.5	4.0	0.288
SO 21624-A6-1/4	126.1661.110	10	13	32.5	19.0	19.5	13.0	3.5	22.5	4.0	0.451
SO 21624-A6-3/8	126.1661.120	10	17	33.5	23.5	24.0	13.0	4.0	23.5	4.0	0.766
SO 21624-A8-1/8	126.1661.160	10	10	31.5	16.0	16.5	14.0	3.5	23.5	5.1	0.307
SO 21624-A8-1/4	126.1661.170	10	13	33.5	19.5	20.0	14.0	3.5	23.5	6.0	0.466
SO 21624-A8-3/8	126.1661.180	10	17	34.0	23.0	23.5	14.0	4.0	24.5	6.0	0.784
SO 21624-A10-1/4	126.1661.270	10	13	34.5	19.0	19.5	15.0	3.5	24.5	8.0	0.469
SO 21624-A10-3/8	126.1661.280	10	17	35.5	23.5	24.0	15.0	4.0	25.5	8.0	0.779
SO 21624-A10-1/2	126.1661.285	10	19	40.5	30.0	31.0	15.0	6.0	28.5	8.0	1.281
SO 21624-A12-1/4	126.1661.380	10	13	38.0	19.0	19.5	18.5	3.5	28.0	6.5	0.529
SO 21624-A12-3/8	126.1661.390	10	17	39.5	23.0	23.5	19.0	4.0	29.5	10.0	0.798
SO 21624-A12-1/2	126.1661.400	10	19	44.0	29.5	30.5	19.0	6.0	32.5	10.0	1.279
SO 21624-A16-3/8	126.1661.564	10	17	45.5	23.5	24.0	25.0	4.0	35.5	9.8	1.041
SO 21624-A16-1/2	126.1661.566	10	19	50.5	30.0	31.0	25.0	6.0	38.5	13.0	1.510
SO 21624-A16-3/4	126.1661.568	10	22	55.0	35.0	36.0	25.0	7.0	41.0	13.0	2.405

Empfehlung: Für die einfache und korrekte Platzierung des Klemmrings die Montagehilfe AC 870 verwenden.

Recommendation: Pour un positionnement facile et correct de la bague de serrage, utiliser l'aide au montage AC 870.

Recommendation: For easy and correct placement of the compression ferrule, use the assembly aid AC 870.

Anwendungsbeispiele:

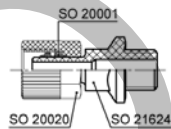

Mögliche Kombinationen:
 - mit Armaturenanschluss zu einstellbaren Anschlüssen
 - mit Verschraubungen/Ventilen zu einstellbaren Verschraubungen/Ventilen

Exemples d'utilisation:

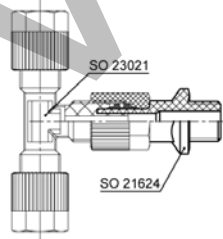

Combinaisons possibles:
 - avec écrou de raccordement ça donne des raccords orientables
 - avec raccords/vannes ça donne des raccords/vannes orientables

Sample combinations:

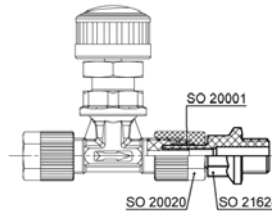

Possible combinations:
 - with nut connection to adjustable connections
 - with unions/valves to adjustable unions/valves

Einbauempfehlung:

Conseil de montage:

Recommendation for installation:

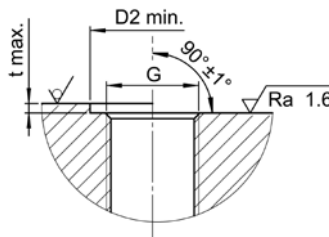

Ad=Aussen-ø der Andrehung
 e=kleinste Bohrung

Ad=ø extérieur de la portée cylindrique
 e=ø-min. de passage

Ad=outside diameter of cyl. stub
 e=minimum bore

Einstellnippel

mit O-Ringabdichtung (FKM)

Adaptateur orientable mâle

avec joint torique (FKM)

Adjustable male adaptor

with O-ring seal (FKM)

SO 21624 OR

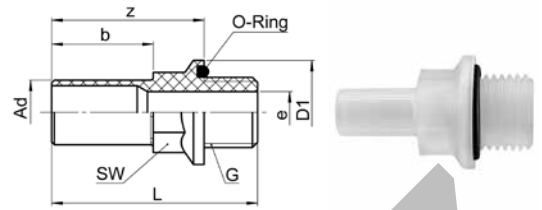

Type -Ad-G	Mat.-Nr.	bar +	SW	L	D1	D2	b	O-Ring	t	z	e	kg/100
G=Rohrgewinde (zylindrisch)												
G=Filetage-gaz BSP (cylindrique)												
G=BSP thread (parallel)												
SO 21624-A6-1/8 OR	126.1681.100	10	10	30.5	16.0	16.5	13.0	9.25x1.78	3.5	22.5	4.0	0.268
SO 21624-A6-1/4 OR	126.1681.110	10	13	32.5	19.5	20.0	13.0	12.42x1.78	3.5	22.5	4.0	0.425
SO 21624-A6-3/8 OR	126.1681.120	10	17	33.5	23.5	24.0	13.0	15.6x1.78	3.5	23.5	4.0	0.730
SO 21624-A8-1/8 OR	126.1681.160	10	10	31.5	16.0	16.5	14.0	9.25x1.78	3.5	23.5	5.1	0.288
SO 21624-A8-1/4 OR	126.1681.170	10	13	33.0	19.5	20.0	14.0	12.42x1.78	3.5	23.5	6.0	0.440
SO 21624-A8-3/8 OR	126.1681.180	10	17	34.5	23.5	24.0	14.0	15.6x1.78	3.5	24.5	6.0	0.745
SO 21624-A10-1/4 OR	126.1681.270	10	13	34.0	19.5	20.0	15.0	12.42x1.78	3.5	24.5	8.0	0.443
SO 21624-A10-3/8 OR	126.1681.280	10	17	35.0	23.5	24.0	15.0	15.6x1.78	3.5	25.5	8.0	0.740
SO 21624-A10-1/2 OR	126.1681.285	10	19	40.5	30.0	31.0	15.0	20.29x2.62	5.5	28.5	8.0	1.185
SO 21624-A12-1/4 OR	126.1681.380	10	13	38.5	19.5	20.0	19.0	12.42x1.78	3.5	28.5	6.5	0.508
SO 21624-A12-3/8 OR	126.1681.390	10	17	39.0	23.5	24.0	18.5	15.6x1.78	3.5	29.0	10.0	0.762
SO 21624-A12-1/2 OR	126.1681.400	10	19	44.5	29.5	30.5	19.0	20.29x2.62	5.5	32.5	10.0	1.182
SO 21624-A16-3/8 OR	126.1681.564	10	17	45.5	23.5	24.0	25.0	12.42x1.78	3.5	35.5	9.8	0.996
SO 21624-A16-1/2 OR	126.1681.566	10	19	50.0	30.0	31.0	24.5	20.29x2.62	5.5	38.0	13.0	1.412
SO 21624-A16-3/4 OR	126.1681.568	10	22	55.0	35.0	36.0	25.0	27.0x3.0	7.0	41.0	13.0	2.286

Einsatztemperaturbereich: -20°C bis +100°C

Plage de température de service: -20°C à +100°C

Operating temperature range: -20°C to +100°C

Empfehlung: Für die einfache und korrekte Platzierung des Klemmrings die Montagehilfe AC 870 verwenden.

Recommendation: Pour un positionnement facile et correct de la bague de serrage, utiliser l'aide au montage AC 870.

Recommendation: For easy and correct placement of the compression ferrule, use the assembly aid AC 870.

Anwendungsbeispiele:

Exemples d'utilisation:

Sample combinations:

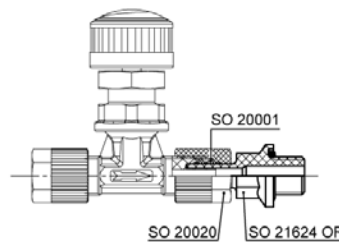
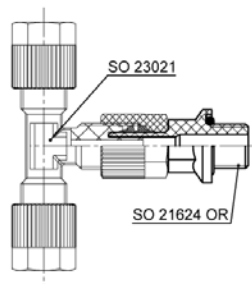
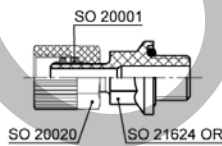

Mögliche Kombinationen:

- mit Armaturenanschluss zu einstellbaren Anschlüssen
- mit Verschraubungen/Ventilen zu einstellbaren Verschraubungen/Ventilen

Combinaisons possibles:

- avec écrou de raccordement ça donne des raccords orientables
- avec raccords/vannes ça donne des raccords/vannes orientables

Possible combinations:

- with nut connection to adjustable connections
- with unions/valves to adjustable unions/valves

Fortsetzung nächste Seite

Suite à la prochaine page

Continued on next page

Ad=Aussen-ø der Andrehung
e=kleinste Bohrung

Ad=ø extérieur de la portée cylindrique
e=ø-min. de passage

Ad=outside diameter of cyl. stub
e=minimum bore

Einbauempfehlung:

Conseil de montage:

Recommendation for installation:

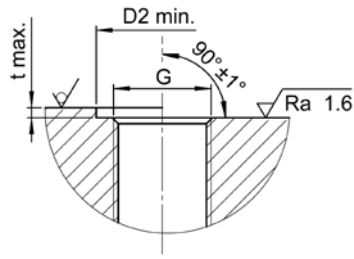

KOLVANZ.CZ

Einstellnippel METR

mit O-Ringabdichtung (FKM)

Adaptateur orientable mâle METR

avec joint torique (FKM)

Adjustable male adaptor METR

with O-ring seal (FKM)

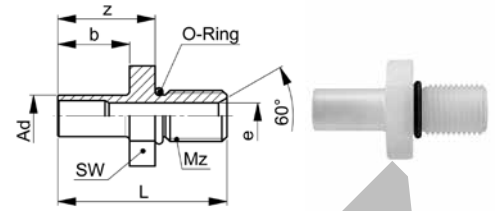

SO 21624 60° OR METR

Type -Ad -Mz	Mat.-Nr.	bar +	SW	L	D	b	t	O-Ring	z	e	kg/100
Mz=metrisches Gewinde (zylindrisch)	Mz=Filetage métrique (cylindrique)	Mz=Metric thread (parallel)									
SO 21624-A8-M10x1/60° OR	126.1683.230	10	17	33.0	21.0	14.0	1.0	8.0x1.5	19.0	5.1	0.400
SO 21624-A8-M12x1/60° OR	126.1683.235	10	17	33.0	21.0	14.0	1.0	10.0x1.5	19.0	5.1	0.500

Einsatztemperaturbereich: -20°C bis +100°C

Plage de température de service: -20°C à +100°C

Operating temperature range: -20°C to +100°C

Empfehlung: Für die einfache und korrekte Platzierung des Klemmrings die Montagehilfe AC 870 verwenden.

Recommendation: Pour un positionnement facile et correct de la bague de serrage, utiliser l'aide au montage AC 870.

Recommendation: For easy and correct placement of the compression ferrule, use the assembly aid AC 870.

Einbauempfehlung:

Conseil de montage:

Recommendation for installation:

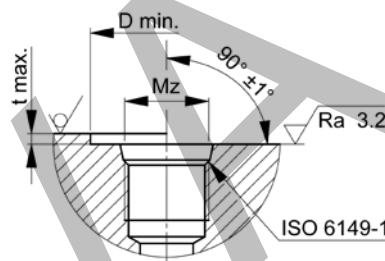

Reduktions-Einstellverschraubung

Raccord de réduction orientable

Adjustable reduction union

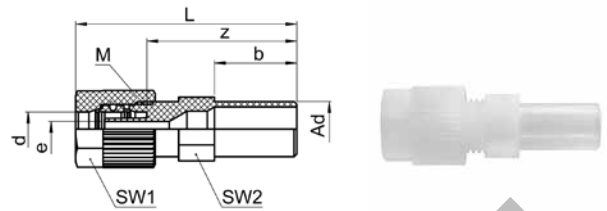

SO 21821

Type -Ad-d	Mat.-Nr.	bar +	M	SW1	SW2	L	b	z	e	kg/100
* SO 21821-A8-4	128.1800.132	10	10x1.0	12	10	38.0	14.0	26.0	3.1	0.428
SO 21821-A8-6	128.1800.140	10	10x1.0	12	10	37.5	14.0	26.5	2.8	0.435
SO 21821-A10-6	128.1800.175	10	10x1.0	12	10	38.5	15.0	27.5	2.8	0.446
SO 21821-A10-8	128.1800.190	10	12x1.0	14	12	40.5	15.0	27.5	4.8	0.588
SO 21821-A12-6	128.1800.215	10	10x1.0	12	10	43.0	19.0	32.0	2.8	0.509
SO 21821-A12-8	128.1800.225	10	12x1.0	14	12	45.0	19.0	32.0	4.8	0.621
SO 21821-A12-10	128.1800.240	10	14x1.0	17	14	45.5	19.0	31.5	6.6	0.934
▼ SO 21821-A12-10/7	128.1800.242	10	14x1.0	17	14	45.5	19.0	31.5	5.6	0.941
SO 21821-A16-12	128.1800.480	10	16x1.0	19	17	56.0	25.0	37.5	8.0	1.441

Empfehlung: Für die einfache und korrekte Platzierung des Klemmrings die Montagehilfe AC 870 verwenden.

Recommendation: Pour un positionnement facile et correct de la bague de serrage, utiliser l'aide au montage AC 870.

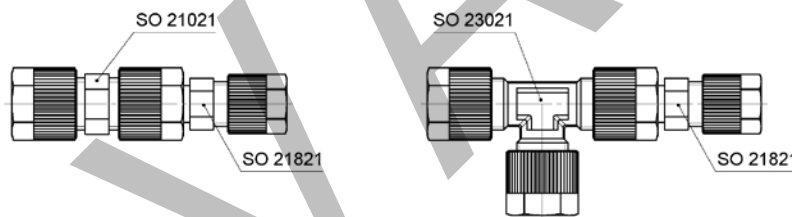
Recommendation: For easy and correct placement of the compression ferrule, use the assembly aid AC 870.

Anwendungsbeispiele:
Exemples d'utilisation:
Sample combinations:

Mit dieser Reduktion können Verschraubungen reduziert werden.

Cette réduction permet de réduire les raccords.

Unions can be reduced with this reduction.

d=Rohrussen- \varnothing / mit Wandung 1 mm
 Ad=Aussen- \varnothing der Andrehung
 L=Mass in montiertem Zustand
 ▼=für Rohre mit Wandung 1,5 mm
 *=mit reduziertem Klemmring

d= \varnothing extérieur du tube / avec paroi de 1 mm
 Ad= \varnothing extérieur de la portée cylindrique
 L=après montage
 ▼=pour tubes avec paroi de 1,5 mm d'épaisseur
 *=avec bague de serrage de réduction

d=tube outside diameter / with wall thickness 1 mm
 Ad=outside diameter of cyl. stub
 L=installed length
 ▼=for tubes with wall thickness of 1,5 mm
 *=with reduction compression ferrule

Winkelverschraubung

Coude

Elbow union

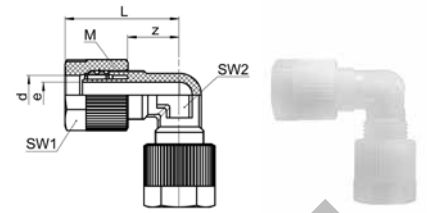

SO 22021

Type -d	Mat.-Nr.	bar +	M	SW1	SW2	L	z	e	kg/100
* SO 22021-4	128.2000.040	10	10x1.0	12	8	26.0	14.0	2.8	0.770
SO 22021-6	128.2000.060	10	10x1.0	12	8	25.0	14.0	2.8	0.782
SO 22021-8	128.2000.080	10	12x1.0	14	10	27.5	14.5	4.8	1.040
SO 22021-10	128.2000.100	10	14x1.0	17	12	30.0	16.0	6.6	1.679
▼ SO 22021-10/7	128.2000.102	10	14x1.0	17	12	30.0	16.0	5.6	1.727
SO 22021-12	128.2000.120	10	16x1.0	19	13	34.5	16.0	8.0	2.188
▼ SO 22021-12/9	128.2000.122	10	16x1.0	19	13	34.5	16.0	7.0	2.242
▼ SO 22021-16/13	128.2000.160	10	22x1.5	24	19	45.5	23.0	11.0	4.989

d=Rohrassen- \varnothing / mit Wandung 1 mm
 e=kleinste Bohrung
 L=Mass in montiertem Zustand
 ▼=für Rohre mit Wandung 1,5 mm
 *=mit reduziertem Klemmring

d= \varnothing extérieur du tube / avec paroi de 1 mm
 e= \varnothing -min. de passage
 L=après montage
 ▼=pour tubes avec paroi de 1,5 mm d'épaisseur
 *=avec bague de serrage de réduction

d=tube outside diameter / with wall thickness 1 mm
 e=minimum bore
 L=installed length
 ▼=for tubes with wall thickness of 1,5 mm
 *=with reduction compression ferrule

Winkelverschraubung

mit Übergangsmuffe SO 20030

Coude

avec adaptateur femelle SO 20030

Elbow union

with female adaptor SO 20030

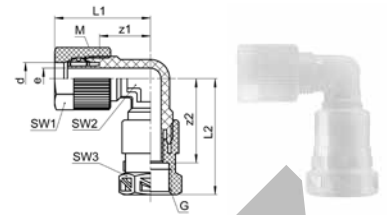

SO 22221

Type -d-G	Mat.-Nr.	bar +	M	SW1	SW2	SW3	L1	L2	z1	z2	e	kg/100
G=Rohrgewinde (zylindrisch)	G=Filetage-gaz BSP (cylindrique)	G=BSP thread (parallel)										
* SO 22221-4-1/8	128.2201.060	10	10x1.0	12	8	14	26.0	31.0	14.0	22.0	2.8	0.550
* SO 22221-4-1/4	128.2201.065	10	10x1.0	12	8	17	26.0	32.0	14.0	22.0	2.8	0.670
SO 22221-6-1/8	128.2201.100	10	10x1.0	12	8	14	25.0	31.0	14.0	22.0	2.8	0.535
SO 22221-6-1/4	128.2201.110	10	10x1.0	12	8	17	25.0	32.0	14.0	22.0	2.8	0.655
SO 22221-8-1/4	128.2201.170	10	12x1.0	14	10	17	27.5	33.5	14.5	23.5	4.8	0.769
SO 22221-10-1/4	128.2201.270	10	14x1.0	17	12	17	30.0	36.5	16.0	26.5	6.6	1.062
SO 22221-10-3/8	128.2201.280	10	14x1.0	17	12	22	30.0	37.5	16.0	26.5	6.6	1.284
▼ SO 22221-107-1/4	128.2201.320	10	14x1.0	17	12	17	30.0	36.5	16.0	26.5	5.6	1.062
▼ SO 22221-107-3/8	128.2201.330	10	14x1.0	17	12	22	30.0	37.5	16.0	26.5	5.6	1.284
SO 22221-12-3/8	128.2201.390	10	16x1.0	19	13	22	34.5	39.0	16.0	28.0	8.0	1.560
SO 22221-12-1/2	128.2201.400	10	16x1.0	19	13	27	34.5	42.5	16.0	28.5	8.0	2.086
▼ SO 22221-129-3/8	128.2201.412	10	16x1.0	19	13	22	34.5	39.0	16.0	28.0	7.0	1.560
▼ SO 22221-129-1/2	128.2201.414	10	16x1.0	19	13	27	34.5	42.5	16.0	28.5	7.0	2.086
▼ SO 22221-16/13-3/8	128.2201.564	10	22x1.5	24	19	22	45.5	52.5	23.0	41.5	11.0	2.685
▼ SO 22221-16/13-1/2	128.2201.566	10	22x1.5	24	19	27	45.5	56.0	23.0	42.0	11.0	3.155
▼ SO 22221-16/13-3/4	128.2201.568	10	22x1.5	24	19	32	45.5	57.5	23.0	42.5	11.0	3.424

Montagehinweis: Muffe ist handfest montiert. Bei Endmontage mit 1/4 Umdrehung anziehen.

Wir empfehlen eine zusätzliche Schmierung auf der Planfläche.

Note d'installation: L'adaptateur femelle est monté serré à la main. Pour le montage final, serrer avec 1/4 de tour.

Nous recommandons une lubrification supplémentaire sur la surface plane.

Assembly information: Female adaptor is mounted finger-tight. For final assembly, tighten with 1/4 turn.

We recommend additional lubrication on the plane surface.

d=Rohrussen-ø / mit Wandung 1 mm

e=kleinste Bohrung

L=Mass in montiertem Zustand

▼=für Rohre mit Wandung 1,5 mm

*=mit reduziertem Klemmring

d=ø extérieur du tube / avec paroi de 1 mm

e=ø-min. de passage

L=après montage

▼=pour tubes avec paroi de 1,5 mm d'épaisseur

*=avec bague de serrage de réduction

d=tube outside diameter / with wall thickness 1 mm

e=minimum bore

L=installed length

▼=for tubes with wall thickness of 1,5 mm

*=with reduction compression ferrule

Winkel-Einschraubverschraubung

Coude mâle

Male adaptor elbow union

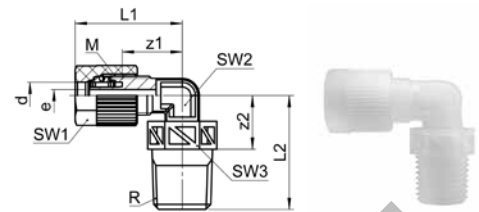

SO 22421

Type -d -R	Mat.-Nr.	bar +	M	SW1	SW2	SW3	L1	L2	z1	z2	e	kg/100
R=Rohrgewinde (kegelig)	R=Filetage-gaz BSP (conique)	R=BSP thread (tapered)										
★ SO 22421-4-1/8	128.2401.060	10	10x1.0	12	8	10	26.0	19.0	14.0	11.0	3.0	0.564
★ SO 22421-4-1/4	128.2401.065	10	10x1.0	12	8	14	26.0	24.5	14.0	12.5	3.0	0.785
SO 22421-6-1/8	128.2401.100	10	10x1.0	12	8	10	25.0	19.0	14.0	11.0	2.8	0.570
SO 22421-6-1/4	128.2401.110	10	10x1.0	12	8	14	25.0	24.5	14.0	12.5	2.8	0.791
SO 22421-8-1/8	128.2401.160	10	12x1.0	14	10	10	27.5	20.0	14.5	12.0	4.8	0.720
SO 22421-8-1/4	128.2401.170	10	12x1.0	14	10	14	27.5	25.5	14.5	13.5	4.8	0.941
SO 22421-10-1/4	128.2401.270	10	14x1.0	17	12	14	30.0	26.5	16.0	14.5	6.6	1.291
SO 22421-10-3/8	128.2401.280	10	14x1.0	17	12	17	30.0	27.0	16.0	15.0	6.6	1.511
▼ SO 22421-10/7-1/4	128.2401.320	10	14x1.0	17	12	14	30.0	26.5	16.0	14.5	5.6	1.314
▼ SO 22421-10/7-3/8	128.2401.330	10	14x1.0	17	12	17	30.0	27.0	16.0	15.0	5.6	1.531
SO 22421-12-1/4	128.2401.380	10	16x1.0	19	13	14	34.5	27.5	16.0	15.5	6.7	1.576
SO 22421-12-3/8	128.2401.390	10	16x1.0	19	13	17	34.5	28.0	16.0	16.0	8.0	1.774
SO 22421-12-1/2	128.2401.400	10	16x1.0	19	13	22	34.5	35.5	16.0	19.5	8.0	2.349
▼ SO 22421-12/9-1/4	128.2401.410	10	16x1.0	19	13	14	34.5	27.5	16.0	15.5	6.7	1.604
▼ SO 22421-12/9-3/8	128.2401.412	10	16x1.0	19	13	17	34.5	28.0	16.0	16.0	7.0	1.801
▼ SO 22421-12/9-1/2	128.2401.414	10	16x1.0	19	13	22	34.5	35.5	16.0	19.5	7.0	2.401
▼ SO 22421-16/13-3/8	128.2401.564	10	22x1.5	24	19	17	45.5	31.0	23.0	19.0	8.0	2.940
▼ SO 22421-16/13-1/2	128.2401.566	10	22x1.5	24	19	22	45.5	38.5	23.0	22.5	11.0	3.339

Winkel-Einschraubverschraubung NPT

Coude mâle NPT

Male adaptor elbow union NPT

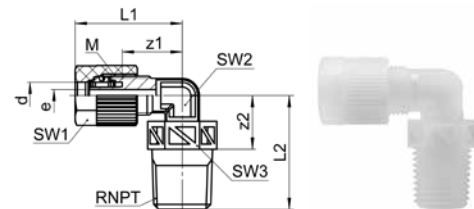

SO 22421 NPT

Type -d -RNPT	Mat.-Nr.	bar +	M	SW1	SW2	SW3	L1	L2	z1	z2	e	kg/100
RNPT=NPT Gewinde	RNPT=Filetage NPT	RNPT=NPT thread										
★ SO 22421-4-1/8 NPT	128.2402.060	10	10x1.0	12	8	11	26.0	21.0	14.0	11.0	2.8	0.614
★ SO 22421-4-1/4 NPT	128.2402.065	10	10x1.0	12	8	14	26.0	26.5	14.0	12.5	2.8	0.834
SO 22421-6-1/8 NPT	128.2402.100	10	10x1.0	12	8	11	25.0	21.0	14.0	11.0	2.8	0.620
SO 22421-6-1/4 NPT	128.2402.110	10	10x1.0	12	8	14	25.0	26.5	14.0	12.5	2.8	0.840
SO 22421-8-1/8 NPT	128.2402.160	10	12x1.0	14	10	11	27.5	22.0	14.5	12.0	4.8	0.771
SO 22421-8-1/4 NPT	128.2402.170	10	12x1.0	14	10	14	27.5	27.5	14.5	13.5	4.8	0.990
SO 22421-10-1/4 NPT	128.2402.270	10	14x1.0	17	12	14	30.0	28.5	16.0	14.5	6.6	1.335
SO 22421-10-3/8 NPT	128.2402.280	10	14x1.0	17	12	17	30.0	29.0	16.0	15.0	6.6	1.572
▼ SO 22421-10/7-1/4 NPT	128.2402.320	10	14x1.0	17	12	14	30.0	28.5	16.0	14.5	5.6	1.358
▼ SO 22421-10/7-3/8 NPT	128.2402.330	10	14x1.0	17	12	17	30.0	29.0	16.0	15.0	5.6	1.596

d=Rohrussen-ø / mit Wandung 1 mm
 e=kleinste Bohrung
 L=Mass in montiertem Zustand
 ▼=für Rohre mit Wandung 1,5 mm
 *=mit reduziertem Klemmring

d=ø extérieur du tube / avec paroi de 1 mm
 e=ø-min. de passage
 L=après montage
 ▼=pour tubes avec paroi de 1,5 mm d'épaisseur
 *=avec bague de serrage de réduction

d=tube outside diameter / with wall thickness 1 mm
 e=minimum bore
 L=installed length
 ▼=for tubes with wall thickness of 1,5 mm
 *=with reduction compression ferrule

Winkel-Einschraubverschraubung METR

Coude mâle METR

Male adaptor elbow union METR

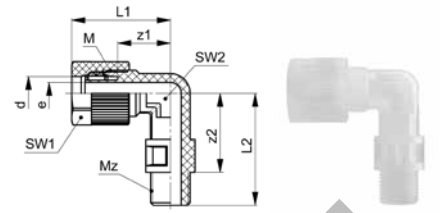

SO 22421 METR

Type -d -Mz	Mat.-Nr.	bar +	M	SW1	SW2	L1	L2	z1	z2	e	kg/100
Mz=metrisches Gewinde (zylindrisch)	Mz=Filetage métrique (cylindrique)	Mz=Metric thread (parallel)									
SO 22421-10-M12x1	128.2403.273	10	14x1.0	17	12	30.0	34.0	16.0	24.0	6.6	1.300

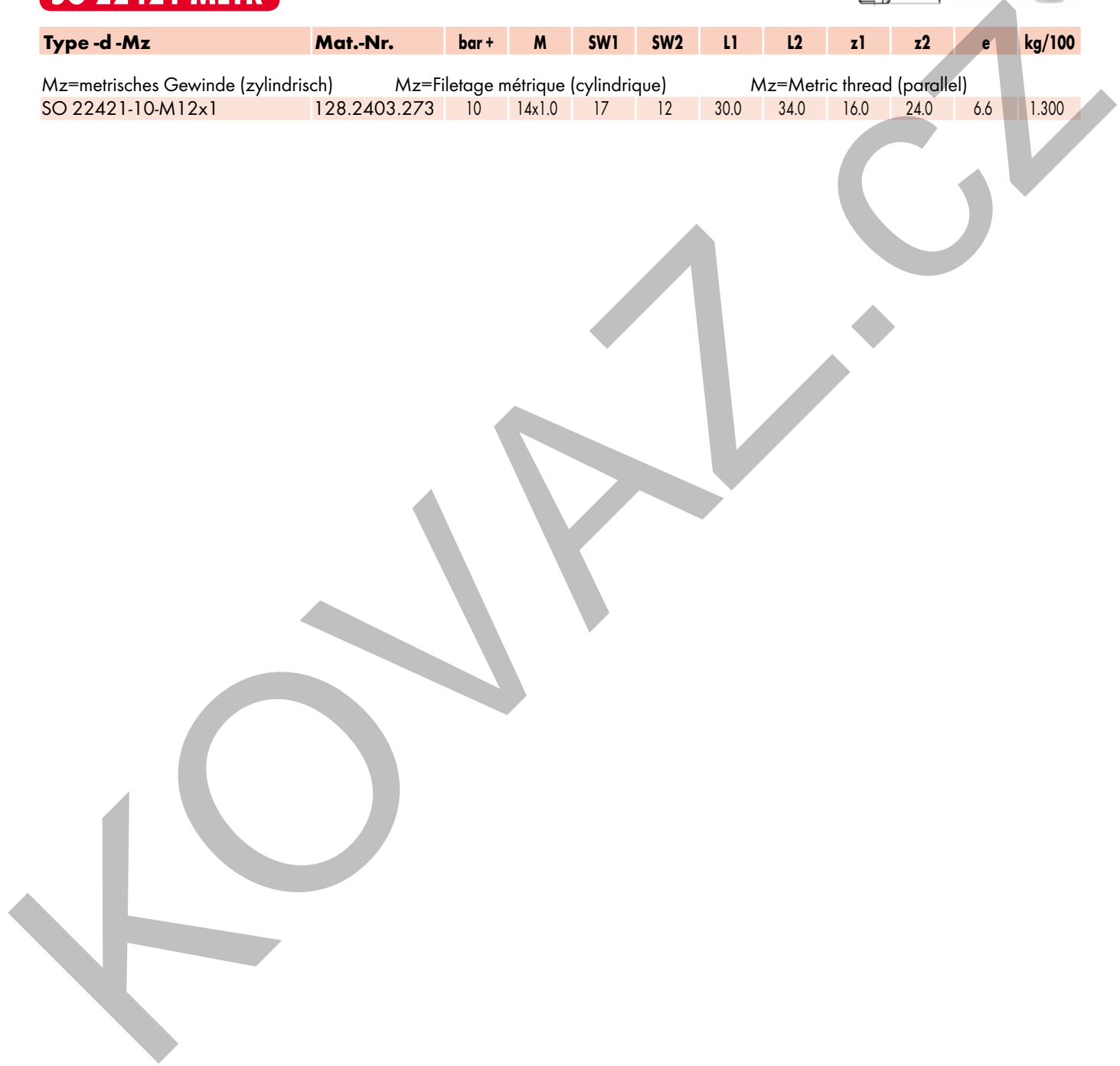

d=Rohrussen-ø / mit Wandung 1 mm
 e=kleinste Bohrung
 L=Mass in montiertem Zustand
 ▼=für Rohre mit Wandung 1,5 mm
 *=mit reduziertem Klemmring

d=ø extérieur du tube / avec paroi de 1 mm
 e=ø-min. de passage
 L=après montage
 ▼=pour tubes avec paroi de 1,5 mm d'épaisseur
 *=avec bague de serrage de réduction

d=tube outside diameter / with wall thickness 1 mm
 e=minimum bore
 L=installed length
 ▼=for tubes with wall thickness of 1,5 mm
 *=with reduction compression ferrule

Einstellbare Winkelverschraubung

Coude orientable

Adjustable elbow union

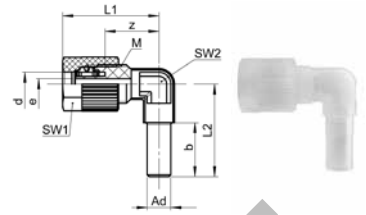

SO 22621

Type -d -Ad	Mat.-Nr.	bar +	M	SW1	SW2	L1	L2	b	z	e	kg/100
* SO 22621-4-A6	128.2600.045	10	10x1.0	12	8	26.0	24.0	14.0	14.0	2.8	0.516
SO 22621-6-A6	128.2600.060	10	10x1.0	12	8	25.0	24.0	14.0	14.0	2.8	0.507
SO 22621-8-A8	128.2600.080	10	12x1.0	14	10	27.5	25.0	16.0	14.5	4.8	0.695
SO 22621-10-A10	128.2600.100	10	14x1.0	17	12	30.0	29.0	18.0	16.0	6.5	1.082
SO 22621-12-A12	128.2600.120	10	16x1.0	19	13	34.5	32.0	21.0	16.0	8.0	1.399

Empfehlung: Für die einfache und korrekte Platzierung des Klemmrings die Montagehilfe AC 870 verwenden.

Recommendation: Pour un positionnement facile et correct de la bague de serrage, utiliser l'aide au montage AC 870.

Recommendation: For easy and correct placement of the compression ferrule, use the assembly aid AC 870.

Anwendungsbeispiele:

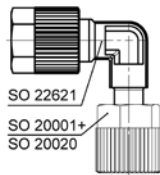

Exemples d'utilisation:

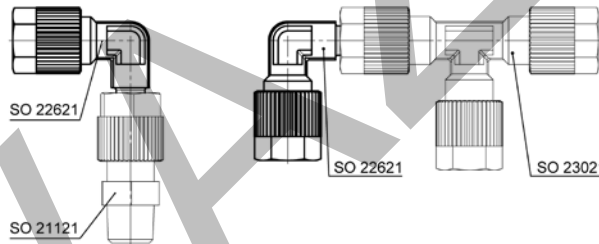

Sample combinations:

Mögliche Kombinationen:

- mit Armatureanschluss zu einstellbaren Winkelverschraubungen
- mit Verschraubungen zu einstellbaren Verschraubungen
- mit Einschraubverschraubungen zu einstellbaren Einschraubwinkeln. Gegenüber dem Einschraubwinkel lässt sich diese Kombination einfacher einstellen, da Einschrauben und Ausrichten getrennt voneinander vorgenommen werden.

Combinaisons possibles:

- avec écrou de raccordement ça donne des raccords coudé orientables
- avec raccords ça donne des raccords orientables
- avec une union mâle ça donne un coude fileté orientable. Par rapport au coude orientable, cette combinaison est facile à régler, puisque le vissage et l'alignement sont réalisés séparément l'un de l'autre.

Possible combinations:

- with a nut connection to adjustable elbow unions
- with a union to adjustable unions
- with a male adaptor union to adjustable male adaptor elbow unions. This combination is simpler to produce, as screwing in and alignment are carried out separately.

d=Rohrassen- \varnothing / mit Wandung 1 mm
Ad=Aussen- \varnothing der Andrehung
L=Mass in montiertem Zustand
*=mit reduziertem Klemmring

d= \varnothing extérieur du tube / avec paroi de 1 mm
Ad= \varnothing extérieur de la portée cylindrique
L=après montage
*=avec bague de serrage de réduction

d=tube outside diameter / with wall thickness 1 mm
Ad=outside diameter of cyl. stub
L=installed length
*=with reduction compression ferrule

Winkel-Schottverschraubung

Durchführungslänge max. 6 mm

Coude traversée de cloison

pour cloison max. 6 mm

Panel mount elbow union

max. panel thickness 6 mm

SO 22721

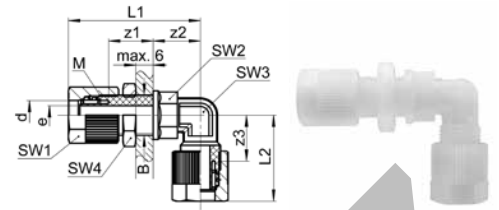

Type -d	Mat.-Nr.	bar +	M	SW1	SW2	SW3	SW4	L1	L2	B	z1	z2	z3	e	kg/100
* SO 22721-4	128.2700.040	10	10x1.0	12	10	8	14	41.0	26.0	10.5	16.0	13.0	14.0	2.8	1.142
SO 22721-6	128.2700.060	10	10x1.0	12	10	8	14	40.0	25.0	10.5	16.0	13.0	14.0	2.8	1.122
SO 22721-8	128.2700.080	10	12x1.0	14	12	10	17	43.0	27.5	12.5	15.0	15.0	14.5	4.7	1.506
SO 22721-10	128.2700.100	10	14x1.0	17	14	12	19	46.0	30.0	14.5	15.5	16.5	16.0	6.6	2.136
▼ SO 22721-10/7	128.2700.102	10	14x1.0	17	14	12	19	46.0	30.0	14.5	15.5	16.5	16.0	5.6	3.062
SO 22721-12	128.2700.120	10	16x1.0	19	17	13	22	49.5	34.5	16.5	13.5	17.5	16.0	8.0	2.869
▼ SO 22721-12/9	128.2700.122	10	16x1.0	19	17	13	22	49.5	34.5	16.5	13.5	17.5	16.0	7.0	2.949
▼ SO 22721-16/13	128.2700.160	10	22x1.5	24	22	19	30	53.0	45.5	22.5	11.0	19.5	23.0	11.0	5.848

Sechskantmutter SO 20006

Ecrou à six pans SO 20006

Hexagon nut SO 20006

Winkel-Schottverschraubung METR

Durchführungslänge ca. 6 mm

Coude traversée de cloison METR

pour cloison ca. 6 mm

Panel mount elbow union METR

panel thickness ca. 6 mm

SO 22724 METR

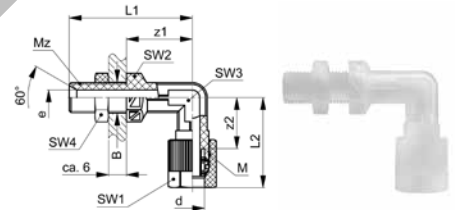

Type -d -Mz	Mat.-Nr.	bar +	M	SW1	SW2	SW3	SW4	L1	L2	B	z1	z2	e	kg/100
Mz=metrisches Gewinde (zylindrisch)			Mz=Filetage métrique (cylindrique)											
			Mz=Metric thread (parallel)											
SO 22724-8-M10x1	128.2705.230	10	12x1.0	14	14	10	14	41.0	30.0	10.5	22.0	17.0	5.1	1.100
SO 22724-8-M12x1	128.2705.235	10	12x1.0	14	14	10	17	42.0	30.0	12.5	22.0	17.0	5.1	1.300

Sechskantmutter SO 20006

Ecrou à six pans SO 20006

Hexagon nut SO 20006

d=Rohrassen-ø / mit Wandung 1 mm

e=kleinste Bohrung

L=Mass in montiertem Zustand

▼=für Rohre mit Wandung 1,5 mm

*=mit reduziertem Klemmring

d=ø extérieur du tube / avec paroi de 1 mm

e=ø-min. de passage

L=après montage

▼=pour tubes avec paroi de 1,5 mm d'épaisseur

*=avec bague de serrage de réduction

d=tube outside diameter / with wall thickness 1 mm

e=minimum bore

L=installed length

▼=for tubes with wall thickness of 1,5 mm

*=with reduction compression ferrule

T-Verschraubung

Té égal

Tee union

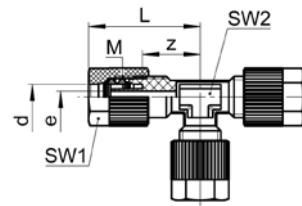

SO 23021

Type-d	Mat.-Nr.	bar +	M	SW1	SW2	L	z	e	kg/100
* SO 23021-4	128.3000.040	10	10x1.0	12	8	26.0	14.0	2.8	1.132
SO 23021-6	128.3000.060	10	10x1.0	12	8	25.0	14.0	2.8	1.149
SO 23021-8	128.3000.080	10	12x1.0	14	10	27.5	14.5	4.8	1.520
SO 23021-10	128.3000.100	10	14x1.0	17	12	30.0	16.0	6.6	2.449
▼ SO 23021-10/7	128.3000.102	10	14x1.0	17	12	30.0	16.0	5.6	2.512
SO 23021-12	128.3000.120	10	16x1.0	19	13	34.5	16.0	8.0	3.202
▼ SO 23021-12/9	128.3000.122	10	16x1.0	19	13	34.5	16.0	7.0	3.275
▼ SO 23021-16/13	128.3000.160	10	22x1.5	24	19	45.5	23.0	11.0	7.211

T-Verschraubung reduziert

Té réduit

Tee reduction union

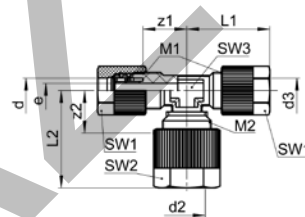

SO 23021 RED

Type-d-d2-d3	Mat.-Nr.	bar +	M1	M2	SW1	SW2	SW3	L1	L2	z1	z2	e	kg/100
SO 23021-8-12-8	128.3004.107	10	12x1.0	16x1.0	14	19	10	27.5	32.5	14.5	14.0	4.8	2.100
SO 23021-12-8-12	128.3004.210	10	16x1.0	12x1.0	19	14	13	34.5	29.5	16.0	16.5	4.8	2.800

d=Rohrussen-ø / mit Wandung 1 mm
 e=kleinste Bohrung
 L=Mass in montiertem Zustand
 ▼=für Rohre mit Wandung 1,5 mm
 *=mit reduziertem Klemmring

d=ø extérieur du tube / avec paroi de 1 mm
 e=ø-min. de passage
 L=après montage
 ▼=pour tubes avec paroi de 1,5 mm d'épaisseur
 *=avec bague de serrage de réduction

d=tube outside diameter / with wall thickness 1 mm
 e=minimum bore
 L=installed length
 ▼=for tubes with wall thickness of 1,5 mm
 *=with reduction compression ferrule

T-Verschraubung

mit Übergangsmuffe SO 20030

Té égal

avec adaptateur femelle SO 20030

Tee union

with female adaptor SO 20030

SO 23221

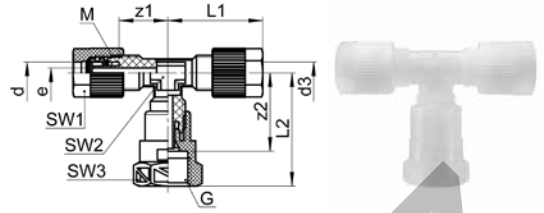

Type	d-G-d3	Mat.-Nr.	bar +	M	SW1	SW2	SW3	L1	L2	z1	z2	e	kg/100
	G=Rohrgewinde (zylindrisch)												
	G=Filetage-gaz BSP (cylindrique)												
	G=BSP thread (parallel)												
★	SO 23221-4-1/8-4	128.3201.060	10	10x1.0	12	8	14	26.0	31.0	14.0	22.0	2.8	1.280
★	SO 23221-4-1/4-4	128.3201.065	10	10x1.0	12	8	17	26.0	31.0	14.0	22.0	2.8	1.420
	SO 23221-6-1/8-6	128.3201.100	10	10x1.0	12	8	14	25.0	31.0	14.0	22.0	2.8	1.240
	SO 23221-6-1/4-6	128.3201.110	10	10x1.0	12	8	17	25.0	31.0	14.0	22.0	2.8	1.380
	SO 23221-8-1/4-8	128.3201.170	10	12x1.0	14	10	17	27.5	33.5	14.5	23.5	4.8	1.930
	SO 23221-10-1/4-10	128.3201.270	10	14x1.0	17	12	17	30.0	36.5	16.0	26.5	6.6	2.810
	SO 23221-10-3/8-10	128.3201.280	10	14x1.0	17	12	22	30.0	37.5	16.0	26.5	6.6	3.290
▼	SO 23221-107-1/4-107	128.3201.320	10	14x1.0	17	12	17	30.0	36.5	16.0	26.5	5.6	2.640
▼	SO 23221-107-3/8-107	128.3201.330	10	14x1.0	17	12	22	30.0	37.5	16.0	26.5	5.6	3.120
	SO 23221-12-3/8-12	128.3201.390	10	16x1.0	19	13	22	34.5	39.0	16.0	28.0	8.0	4.040
	SO 23221-12-1/2-12	128.3201.400	10	16x1.0	19	13	27	34.5	42.5	16.0	28.5	8.0	4.670
▼	SO 23221-129-3/8-129	128.3201.412	10	16x1.0	19	13	22	34.5	39.0	16.0	28.0	7.0	4.020
▼	SO 23221-129-1/2-129	128.3201.414	10	16x1.0	19	13	27	34.5	42.5	16.0	28.5	7.0	4.650
▼	SO 23221-16/13-3/8-16/13	128.3201.564	10	22x1.5	24	19	22	45.5	52.5	23.0	41.5	11.0	8.000
▼	SO 23221-16/13-1/2-16/13	128.3201.566	10	22x1.5	24	19	27	45.5	56.0	23.0	42.0	11.0	8.200
▼	SO 23221-16/13-3/4-16/13	128.3201.568	10	22x1.5	24	19	32	45.5	57.5	23.0	42.5	11.0	8.600

Montagehinweis: Muffe ist handfest montiert. Bei Endmontage mit 1/4 Umdrehung anziehen.
Wir empfehlen eine zusätzliche Schmierung auf der Planfläche.

Note d'installation: L'adaptateur femelle est monté serré à la main. Pour le montage final, serrer avec 1/4 de tour.
Nous recommandons une lubrification supplémentaire sur la surface plane.

Assembly information: Female adaptor is mounted finger-tight. For final assembly, tighten with 1/4 turn.
We recommend additional lubrication on the plane surface.

d=Rohrussen-ø / mit Wandung 1 mm
e=kleinste Bohrung
L=Mass in montiertem Zustand
▼=für Rohre mit Wandung 1,5 mm
*=mit reduziertem Klemmring

d=ø extérieur du tube / avec paroi de 1 mm
e=ø-min. de passage
L=après montage
▼=pour tubes avec paroi de 1,5 mm d'épaisseur
*=avec bague de serrage de réduction

d=tube outside diameter / with wall thickness 1 mm
e=minimum bore
L=installed length
▼=for tubes with wall thickness of 1,5 mm
*=with reduction compression ferrule

Einstellbare T-Verschraubung

Té orientable au centre

Adjustable tee union

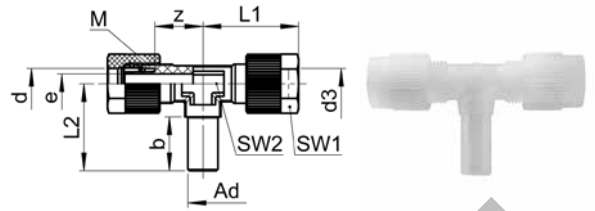

SO 23621 T

Type -d -Ad -d3	Mat.-Nr.	bar +	M	SW1	SW2	L1	L2	b	z	e	kg/100
SO 23621-6-A6-6	128.3600.060	10	10x1.0	12	8	25.0	24.0	14.0	14.0	2.8	0.880
SO 23621-8-A8-8	128.3600.080	10	12x1.0	14	10	27.5	25.0	16.0	14.5	4.8	1.190
SO 23621-10-A10-10	128.3600.100	10	14x1.0	17	12	30.0	29.0	18.0	16.0	6.6	1.830
SO 23621-12-A12-12	128.3600.120	10	16x1.0	19	13	34.5	30.0	21.0	16.0	8.0	2.395

Empfehlung: Für die einfache und korrekte Platzierung des Klemmrings die Montagehilfe AC 870 verwenden.

Recommendation: Pour un positionnement facile et correct de la bague de serrage, utiliser l'aide au montage AC 870.

Recommendation: For easy and correct placement of the compression ferrule, use the assembly aid AC 870.

Anwendungsbeispiele:

Exemples d'utilisation:

Sample combinations:

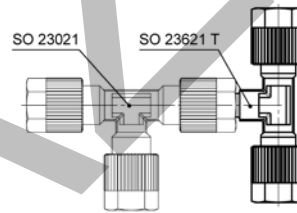
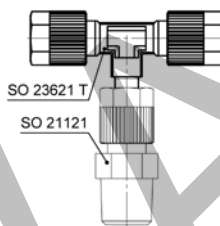
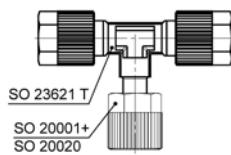

Mögliche Kombinationen:

- mit Armaturenanschluss zu einstellbaren T-Verschraubungen
- mit Verschraubungen zu einstellbaren Verschraubungen
- mit Einschraubverschraubungen zu einstellbaren T-Einschraubverschraubungen. Gegenüber der T-Einschraubverschraubung lässt sich diese Kombination einfacher einstellen, da Einschrauben und Ausrichten getrennt voneinander vorgenommen werden.

Combinaisons possibles:

- avec écrou de raccordement ça donne un Té orientable
- avec raccords ça donne des raccords orientables
- avec une union mâle ça donne un Té fileté orientable. Par rapport au Té orientable, cette combinaison est facile à régler, puisque le vissage et l'alignement sont réalisés séparément l'un de l'autre.

Possible combinations:

- with nut connections to adjustable tee unions
- with unions to adjustable unions
- with male adaptor unions to adjustable male adaptor tee unions. This combination is simpler to produce, as screwing in and alignment are carried out separately.

d=Rohrassen- \varnothing / mit Wandung 1 mm
Ad=Aussen- \varnothing der Andrehung
e=kleinste Bohrung
L=Mass in montiertem Zustand

d= \varnothing extérieur du tube / avec paroi de 1 mm
Ad= \varnothing extérieur de la portée cylindrique
e= \varnothing -min. de passage
L=après montage

d=tube outside diameter / with wall thickness 1 mm
Ad=outside diameter of cyl. stub
e=minimum bore
L=installed length

Einstellbare L-Verschraubung

Té orientable en bout

Adjustable L union

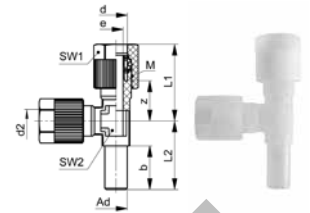

SO 23621 L

Type -d -d2 -Ad	Mat.-Nr.	bar +	M	SW1	SW2	L1	L2	b	z	e	kg/100
SO 23621-8-8-A8	128.3610.080	10	12x1.0	14	10	27.5	25.0	16.0	14.5	5.1	1.200

Empfehlung: Für die einfache und korrekte Platzierung des Klemmrings die Montagehilfe AC 870 verwenden.

Recommendation: Pour un positionnement facile et correct de la bague de serrage, utiliser l'aide au montage AC 870.

Recommendation: For easy and correct placement of the compression ferrule, use the assembly aid AC 870.

Anwendungsbeispiele:

Exemples d'utilisation:

Sample combinations:



Mögliche Kombinationen:

- mit Armaturenanschluss zu einstellbaren L-Verschraubungen
- mit Verschraubungen zu einstellbaren Verschraubungen
- mit Einschraubverschraubungen zu einstellbaren L-Einschraubverschraubungen. Gegenüber der L-Einschraubverschraubung lässt sich diese Kombination einfacher einstellen, da Einschrauben und Ausrichten getrennt voneinander vorgenommen werden.

Combinaisons possibles:

- avec écrou de raccordement ça donne un L orientable
- avec raccords ça donne des raccords orientables
- avec une union mâle ça donne un L fileté orientable. Par rapport au L orientable, cette combinaison est facile à régler, puisque le vissage et l'alignement sont réalisés séparément l'un de l'autre.

Possible combinations:

- with nut connections to adjustable L unions
- with unions to adjustable unions
- with male adaptor unions to adjustable male adaptor L unions. This combination is simpler to produce, as screwing in and alignment are carried out separately.

d=Rohrassens- \varnothing
Ad=Aussen- \varnothing der Andrehung
e=kleinste Bohrung
L=Mass in montiertem Zustand

d= \varnothing extérieur du tube
Ad= \varnothing extérieur de la portée cylindrique
e= \varnothing -min. de passage
L=après montage

d=tube outside diameter
Ad=outside diameter of cyl. stub
e=minimum bore
L=installed length

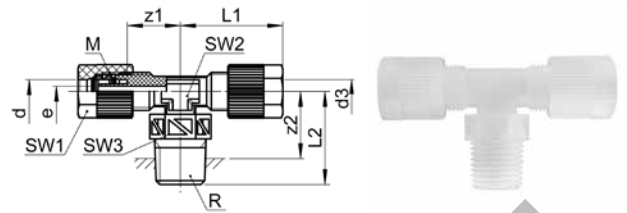
T-Einschraubverschraubung
Té mâle au centre
Male adaptor tee union

SO 23721

Type -d -R -d3	Mat.-Nr.	bar +	M	SW1	SW2	SW3	L1	L2	z1	z2	e	kg/100
R=Rohrgewinde (kegelig)	R=Filetage-gaz BSP (conique)	R=BSP thread (tapered)										
* SO 23721-4-1/8-4	128.3701.040	10	10x1.0	12	8	10	26.0	19.0	14.0	14.0	2.8	0.926
* SO 23721-4-1/4-4	128.3701.045	10	10x1.0	12	8	14	26.0	24.5	14.0	16.5	2.8	1.148
SO 23721-6-1/8-6	128.3701.100	10	10x1.0	12	8	10	25.0	19.0	14.0	13.5	2.8	0.938
SO 23721-6-1/4-6	128.3701.110	10	10x1.0	12	8	14	25.0	24.5	14.0	16.5	2.8	1.160
SO 23721-8-1/8-8	128.3701.160	10	12x1.0	14	10	10	27.5	20.0	14.5	15.0	4.8	1.197
SO 23721-8-1/4-8	128.3701.170	10	12x1.0	14	10	14	27.0	25.5	14.0	17.5	4.8	1.300
SO 23721-10-1/4-10	128.3701.270	10	14x1.0	17	12	14	30.0	26.5	16.0	18.5	6.6	2.058
SO 23721-10-3/8-10	128.3701.280	10	14x1.0	17	12	17	30.0	27.0	16.0	19.0	6.6	1.720
▼ SO 23721-107-1/4-107	128.3701.320	10	14x1.0	17	12	14	30.0	26.5	16.0	18.5	5.6	1.544
▼ SO 23721-107-3/8-107	128.3701.330	10	14x1.0	17	12	17	30.0	27.0	16.0	19.0	5.6	1.762

d=Rohrussen- \varnothing / mit Wandung 1 mm
 e=kleinste Bohrung
 L=Mass in montiertem Zustand
 ▼=für Rohre mit Wandung 1,5 mm
 *=mit reduziertem Klemmring

d= \varnothing extérieur du tube / avec paroi de 1 mm
 e= \varnothing -min. de passage
 L=après montage
 ▼=pour tubes avec paroi de 1,5 mm d'épaisseur
 *=avec bague de serrage de réduction

d=tube outside diameter / with wall thickness 1 mm
 e=minimum bore
 L=installed length
 ▼=for tubes with wall thickness of 1,5 mm
 *=with reduction compression ferrule

Ventile PVDF

Vannes PVDF

Valves PVDF

SO NV 22A00



Reguliertventil mit Innengewinde
 Vanne de réglage avec taraudage
 Regulating valve with female thread

559

SO NV 22A21



Reguliertventil
 Vanne de réglage
 Regulating valve

559

SO NV 22A21E



Reguliert-Eckventil
 Vanne-équerre de réglage
 Elbow regulating valve

560

SO NV 22A21EB



Reguliert-Eckventil mit Einschraubgewinde
 Vanne-équerre de réglage avec filetage
 Elbow regulating valve with male adaptor thread

560

SO NV 22A21EL



Reguliert-Eckventil mit Einstellzapfen
 Vanne-équerre de réglage orientable
 Elbow regulating valve adjustable

561

SO 29900



Anschraubfuß
 Support de fixation
 Flange mount

561

SO CV 23B21



Kegelrückschlagventil
 Clapet anti-retour à siège conique
 Taper seat non-return valve

564

SO BV 28A00



Absperrhahn mit Innengewinde
 Vanne à boisseau avec taraudage
 Stopcock with female thread

566

SO BV 28A21



Absperrhahn
 Vanne à boisseau
 Stopcock

566

SO 20031



Übergangsmuffe G-G
Adaptateur femelle G - femelle G
Female adaptor G-G

702

SO 20041



Übergangsnippel G-R
Adaptateur femelle G - mâle R
Adaptor female G - male R

702

SO 20041 OR



Übergangsnippel G-G mit O-Ringabdichtung (FKM)
Adaptateur femelle G - mâle G avec joint torique (FKM)
Adaptor female G - male G with O-ring seal (FKM)

703

SO 20371



Verschlusschraube R mit Aussen-ókt.
Bouchon fileté R à six pans
Screw plug R with hex-nut

703

SO 20511



Einschraubtülle R
Douille cannelée à visser R
Male adaptor hose nozzle R

703

SO 21109



Doppelnippel R
Mamelon double R
Male threaded adaptor R

704

SERTO Baukasten

Le système modulaire SERTO

The SERTO modular System



Gewindekombinationen

Sie möchten verschiedene Gewindetypen miteinander kombinieren? Auch das ist möglich: die Übergangsmuffen und -nippel ermöglichen mit der Kombination von Standardteilen Übergänge von BSP auf NPT oder metrische Gewinde, von kleinen auf große Gewinde, von Innen- auf Außengewinde. Ebenfalls metallisch dicht. Sie müssen sich keine Gedanken über Temperaturgrenzen oder Beständigkeiten von Dichtmitteln machen.

Les combinaisons de filetages

Vous souhaitez combiner différents types de filetages? Là encore, c'est possible. Les adaptateurs permettent, en association avec des pièces standard, de passer de filetages BSP à des filetages NPT ou à des filetages métriques, de passer de petits à de grands filetages, de filetages femelles à des filetages mâles. Le tout avec étanchéité métallique. Vous n'avez aucun souci à vous faire pour ce qui est des limites de températures ou de la résistance des moyens d'étanchéité.

Thread combinations

You would like to combine different thread types with one another? This can be done too. The female and male adapters together with standard parts enable transitions from BSP to NPT or metric thread, from small to large threads, from internal to external threads. Also with metal-to-metal sealing. You don't have to worry about temperature limits or sealant resistance.

Abschlusselemente

Sie wollen einen Teil des Leitungssystems kurzzeitig stilllegen? Eine Verschlusschraube, die Sie in eine Muffe einschrauben, verschließt einen Anschluss der Verschraubung, somit können Sie mit der Revision oder Reparatur beginnen. Nach diesen Arbeiten verbinden Sie wieder die alte Leitung ohne zusätzlichen Materialaufwand und Kosten.

Éléments de fermeture

Vous voulez supprimer momentanément une partie du système de conduites? Un bouchon fileté que vous vissez dans un adaptateur femelle vous permettra de fermer un raccord de sorte que vous puissiez entamer la révision ou la réparation. Une fois les travaux terminés, il vous suffit de raccorder à nouveau l'ancienne conduite, sans matériau ni coût supplémentaire.

End elements

You want to interrupt the flow in part of the tube system for a short time? A screw plug that you screw into a female adaptor closes off a connecting union so that you can begin with the revision or repair. After the work is completed, you can rejoin the line without any additional materials or costs.

Kunststoff PA

Verschraubungen

Plastique PA

Raccords

Plastic PA

Unions



Seite/Page/Page		Seite/Page/Page		Seite/Page/Page	
428	Klemmring Bague de serrage Compression ferrule		438-440	Einstellnippel Adaptateur orientable mâle Adjustable male adaptor	
SO 30001		SO 31600		449	2-fach Winkel-Schwenkverschraubung Coude banjo double Double banjo
428	Abschlusszapfen Bouchon d'arrêt Plug		441	Reduktions-Einstellverschraubung Raccord de réduction orientable Adjustable reduction union	
SO 30002		SO 31821		450	T-Verschraubung Té égal Tee union
429	Anschlussmutter gerändelt Ecrou moleté Union nut knurled		442	Winkelverschraubung Coude Elbow union	
SO 30020		SO 32021		451	Einstellbare T-Verschraubung Té orientable au centre Adjustable tee union
429	Gerade Verschraubung Union double Straight union		443	Winkel-Einschraubverschraubung Coude mâle Male adaptor elbow union	
SO 31021		SO 32421		452	T-Einschraubverschraubung Té mâle au centre Male adaptor tee union
430-433	Gerade Einschraubverschraubung Union mâle Male adaptor union		444	Einstellbare Winkelverschraubung Coude orientable Adjustable elbow union	
SO 31121		SO 32621		Sonderausführungen auf Anfrage Exécution en option sur demande Optional services on request	
434	Gerade Aufschraubverschraubung Union femelle Female adaptor union		445	Winkelschottverschraubung Coude traversée de cloison Panel mount elbow union	
SO 31221		SO 32721		Vorbeschichtete Gewinde mit Loctite 5061 Filetages pré enduits avec Loctite 5061 Pre-coated threads with Loctite 5061	
435-436	Verbindungsrippel Pièce folle Tube stub		446	Schwenkverschraubung Coude banjo Single banjo	
SO 31300		SO 32821		Bestätigungen auf www.serto.com Confirmations sur www.serto.com Confirmations on www.serto.com	
437	Gerade Schottverschraubung Union double traversée de cloison Panel mount union		447-448	Schwenkverschraubung Coude banjo Single banjo	
SO 31521		SO 37621			

Kunststoff PA

Plastique PA

Plastic PA

Eigenschaften, Besonderheiten

- einfache, schnelle Montage
- preisgünstige Verschraubungsreihe
- grosse Sortimentsvielfalt

Funktionsprinzip

Siehe Kapitel i

Werkstoff

Das Polyamid PA6.6 grau bietet eine sehr gute Festigkeit und Zähigkeit. Die Verschraubungen sind universell einsetzbar, wobei die allgemeine Beständigkeit in jedem Fall berücksichtigt werden muss (s. Beständigkeitsliste im Anhang). Die PA Verschraubungen sind vor direkter UV-Bestrahlung zu schützen.

Betriebsdruck PN

10 bar bei +23 °C (3-fache Sicherheit), höhere Drücke in Kombination mit SERTO Kunststoffrohren auf Anfrage (bar+).

Temperaturbereich

-40 °C bis +80 °C

Anzuschliessende Schläuche

Toleranzhaltige Schläuche mit sauberer Oberfläche und gleichmässiger Wandung. Siehe auch Kapitel i und Kapitel 19.

Kegelige Einschraubgewinde

Zum Abdichten der Einschraubgewinde empfehlen wir das PTFE Band AC 840 oder den Dichtstift «Plasto-Joint» AC 833.

Druckauswertungsgrad in % des PN

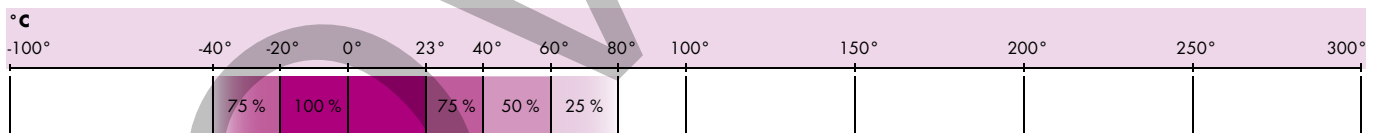

Propriétés, spécificités

- montage facile et rapide
- prix avantageux
- vaste gamme de produits

Principe de fonctionnement

Voir chapitre i

Matériau

Le polyamide PA6.6 gris offre une très bonne résistance et ténacité. Les raccords peuvent être utilisés de manière universelle, la résistance générale doit être considérée dans tous les cas (voir liste des résistances en annexe). Les raccords PA doivent être protégés contre une exposition directe aux rayons UV.

Pression de service PN

10 bar à +23 °C (facteur de sécurité 3), pressions plus élevées en combinaison avec les tubes plastiques SERTO sur demande (bar+).

Plage de température admissible

-40 °C à +80 °C

Tuyaux à utiliser

Tuyaux flexibles respectant les tolérances avec surface propre et d'épaisseur de paroi régulière. Voir aussi chapitre i et chapitre 19.

Filetages mâles coniques

Pour assurer l'étanchéité des filetages mâles, nous recommandons le ruban de PTFE AC 840 ou le bâton «Plasto-Joint» AC 833.

Coefficient de pression de service admissible en % de PN

Characteristics, specialities

- easy and fast to install
- advantageous price
- extensive product range

Operating principle

See chapter i

Material

Polyamide PA6.6 grey offers very good strength and toughness. The fittings can be used universally, whereby the general resistance must be taken into account in any case (see resistance list in the appendix). The PA fittings must be protected against direct UV radiation.

Working pressure PN

10 bar at +23 °C (safety factor of 3), higher pressures in combination with SERTO plastic tubes on request (bar+).

Temperature range

-40 °C to +80 °C

Hoses to use

True to tolerance hoses with clean surface and uniform wall thickness. See also chapter i and chapter 19.

Tapered male threads

For sealing the male threads we recommend the PTFE tape AC 840 or the sealing stick «Plasto-Joint» AC 833.

Pressure coefficient % of PN

Klemmring Bague de serrage Compression ferrule

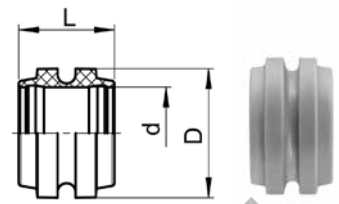

SO 30001

Type -d	Mat.-Nr.	bar +	L	D	kg/100
SO 30001-6	166.0010.060	10	6.4	8.6	0.019
SO 30001-8	166.0010.080	10	6.4	10.7	0.025
SO 30001-10	166.0010.100	10	6.9	12.7	0.032
SO 30001-12	166.0010.120	10	7.5	14.7	0.043

Abschlusszapfen Bouchon d'arrêt Plug

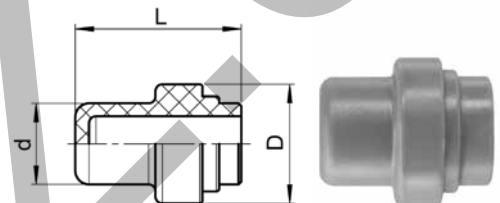

SO 30002

Type -d	Mat.-Nr.	bar +	L	D	kg/100
SO 30002-6	166.0020.060	10	12.0	8.7	0.036
SO 30002-8	166.0020.080	10	12.7	10.8	0.051
SO 30002-10	166.0020.100	10	15.0	12.8	0.078
SO 30002-12	166.0020.120	10	17.0	14.8	0.105

Anwendungsbeispiele:

Exemples d'utilisation:

Sample combinations:

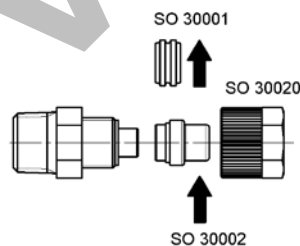

Der Abschlusszapfen lässt sich in jede Verschraubung anstelle eines Klemmrings der gleichen Größe einsetzen.

Montagehinweis: Anschlussmutter mit 1/2 - 1 Umdrehung anziehen.

Le bouchon d'arrêt s'insère dans tout raccord au lieu d'une bague de serrage de la même taille.

Note d'installation: Serrez l'écrou d'accouplement de 1/2 - 1 de tour.

The plug can be inserted into all unions instead of a compression ferrule of the same size.

Assembly information: Tighten the union nut with 1/2 - 1 turn.

Anschlussmutter gerändelt

Ecrou moleté

Union nut knurled

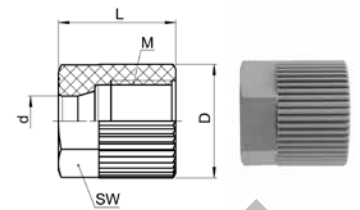

SO 30020

Type-d	Mat.-Nr.	bar +	M	SW	L	D	kg/100
SO 30020-6	166.0100.060	10	10x1.0	12	14.5	14.0	0.160
SO 30020-8	166.0100.080	10	12x1.0	14	16.0	16.0	0.210
SO 30020-10	166.0100.100	10	14x1.0	17	17.5	19.5	0.360
SO 30020-12	166.0100.120	10	16x1.0	19	19.5	22.0	0.480

Gerade Verschraubung

Union double

Straight union

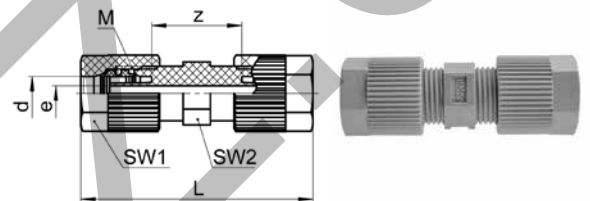

SO 31021

Type-d	Mat.-Nr.	bar +	M	SW1	SW2	L	z	e	kg/100
SO 31021-6	168.1000.060	10	10x1.0	12	10	38.5	16.5	2.8	0.513
SO 31021-8	168.1000.080	10	12x1.0	14	12	44.0	18.0	4.8	0.702
SO 31021-10	168.1000.100	10	14x1.0	17	14	45.5	18.0	6.6	1.096
▼ SO 31021-10/7	168.1000.102	10	14x1.0	17	14	46.0	18.5	5.6	1.111
SO 31021-12	168.1000.120	10	16x1.0	19	17	51.5	16.5	8.0	1.492
▼ SO 31021-12/9	168.1000.122	10	16x1.0	19	17	52.0	17.0	7.0	1.506

d=Rohrassen- \varnothing / mit Wandung 1 mm
 e=kleinste Bohrung
 L=Mass in montiertem Zustand
 ▼=für Rohre mit Wandung 1,5 mm

d= \varnothing extérieur du tube / avec paroi de 1 mm
 e= \varnothing -min. de passage
 L=après montage
 ▼=pour tubes avec paroi de 1,5 mm d'épaisseur

d=tube outside diameter / with wall thickness 1 mm
 e=minimum bore
 L=installed length
 ▼=for tubes with wall thickness of 1,5 mm

Gerade Einschraubverschraubung
Union mâle
Male adaptor union

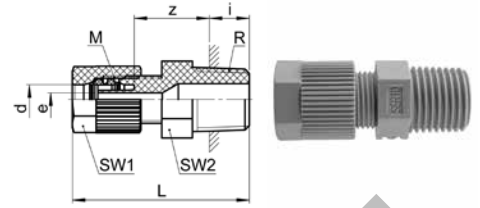

SO 31121

Type -d-R	Mat.-Nr.	bar +	M	SW1	SW2	L	i	z	e	kg/100
R=Rohrgewinde (kegelig)	R=Filetage-gaz BSP (conique)	R=BSP thread (tapered)								
SO 31121-6-1/8	168.1101.100	10	10x1.0	12	12	30.5	5.0	14.5	2.8	0.143
SO 31121-6-1/4	168.1101.110	10	10x1.0	12	14	35.5	8.0	16.5	2.8	0.302
SO 31121-6-3/8	168.1101.120	10	10x1.0	12	17	36.0	8.0	17.0	2.8	0.460
SO 31121-8-1/8	168.1101.160	10	12x1.0	14	12	32.0	5.0	14.0	4.8	0.175
SO 31121-8-1/4	168.1101.170	10	12x1.0	14	14	37.5	8.0	16.5	4.8	0.328
SO 31121-8-3/8	168.1101.180	10	12x1.0	14	17	38.5	8.0	17.5	4.8	0.485
SO 31121-10-1/4	168.1101.270	10	14x1.0	17	14	38.5	8.0	16.5	6.6	0.352
SO 31121-10-3/8	168.1101.280	10	14x1.0	17	17	38.5	8.0	16.5	6.6	0.508
▼ SO 31121-107-1/4	168.1101.320	10	14x1.0	17	14	38.5	8.0	16.5	5.6	0.360
▼ SO 31121-107-3/8	168.1101.330	10	14x1.0	17	17	39.0	8.0	17.0	5.6	0.516
SO 31121-12-1/4	168.1101.380	10	16x1.0	19	14	41.0	8.0	15.5	6.7	0.385
SO 31121-12-3/8	168.1101.390	10	16x1.0	19	17	41.5	8.0	16.0	8.0	0.538
SO 31121-12-1/2	168.1101.400	10	16x1.0	19	22	46.5	10.0	19.0	8.0	0.876
▼ SO 31121-129-1/4	168.1101.410	10	16x1.0	19	14	41.0	8.0	15.5	6.7	0.394
▼ SO 31121-129-3/8	168.1101.412	10	16x1.0	19	17	41.5	8.0	16.0	7.0	0.551
▼ SO 31121-129-1/2	168.1101.414	10	16x1.0	19	22	46.5	10.0	19.0	7.0	0.879

Gerade Einschraubverschraubung NPT
Union mâle NPT
Male adaptor union NPT

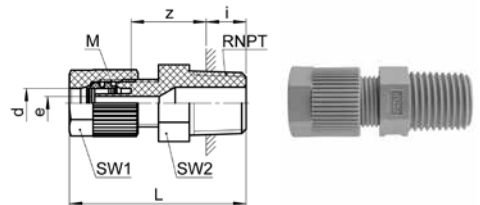

SO 31121 NPT

Type -d-RNPT	Mat.-Nr.	bar +	M	SW1	SW2	L	i	z	e	kg/100
RNPT=NPT Gewinde	RNPT=Filetage NPT	RNPT=NPT thread								
SO 31121-6-1/8 NPT	168.1102.100	10	10x1.0	12	11	32.5	7.0	14.5	2.8	0.165
SO 31121-6-1/4 NPT	168.1102.110	10	10x1.0	12	14	37.5	10.0	16.5	2.8	0.293
SO 31121-8-1/8 NPT	168.1102.160	10	12x1.0	14	11	34.5	7.0	14.5	4.8	0.193
SO 31121-8-1/4 NPT	168.1102.170	10	12x1.0	14	14	40.0	10.0	17.0	4.8	0.321
SO 31121-10-1/4 NPT	168.1102.270	10	14x1.0	17	14	40.5	10.0	16.5	6.6	0.347
SO 31121-10-3/8 NPT	168.1102.280	10	14x1.0	17	17	41.0	10.0	17.0	6.6	0.500
▼ SO 31121-107-1/4 NPT	168.1102.320	10	14x1.0	17	14	41.0	10.0	17.0	5.6	0.353
▼ SO 31121-107-3/8 NPT	168.1102.330	10	14x1.0	17	17	41.0	10.0	17.0	5.6	0.508
▼ SO 31121-129-3/8 NPT	168.1102.412	10	16x1.0	19	17	44.0	10.0	16.0	7.0	1.164

d=Rohrassen-ø / mit Wandung 1 mm
e=kleinste Bohrung
L=Mass in montiertem Zustand
▼=für Rohre mit Wandung 1,5 mm

d=ø extérieur du tube / avec paroi de 1 mm
e=ø-min. de passage
L=après montage
▼=pour tubes avec paroi de 1,5 mm d'épaisseur

d=tube outside diameter / with wall thickness 1 mm
e=minimum bore
L=installed length
▼=for tubes with wall thickness of 1,5 mm

Gerade Einschraubverschraubung

mit Dichtkante

Union mâle

avec arête d'étanchéité

Male adapter union

with edge seal

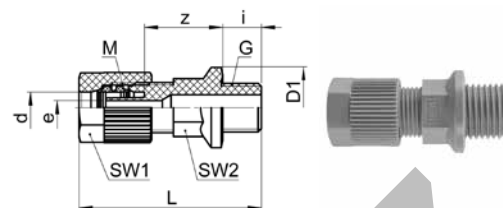

SO 31124

Type -d-G	Mat.-Nr.	bar +	M	SW1	SW2	L	D1	D2	i	t	z	e	kg/100
G=Rohrgewinde (zylindrisch)													
			G=Filetage-gaz BSP (cylindrique)										
											G=BSP thread (parallel)		
SO 31124-6-1/8	168.1161.100	10	10x1.0	12	10	34.5	16.0	16.5	8.0	3.5	15.5	2.8	0.577
SO 31124-6-1/4	168.1161.110	10	10x1.0	12	13	36.5	19.0	19.5	10.0	3.5	15.5	2.8	0.746
SO 31124-8-1/8	168.1161.160	10	12x1.0	14	10	36.5	16.0	16.5	8.0	3.5	15.5	4.8	0.690
SO 31124-8-1/4	168.1161.170	10	12x1.0	14	13	38.5	19.0	19.5	10.0	3.5	15.5	4.8	0.846
SO 31124-10-1/4	168.1161.270	10	14x1.0	17	13	39.0	19.5	20.0	10.0	3.5	15.0	6.6	1.097
SO 31124-10-3/8	168.1161.280	10	14x1.0	17	17	40.0	23.5	24.0	10.0	4.0	16.0	6.6	1.398
SO 31124-12-1/4	168.1161.380	10	16x1.0	19	13	41.5	19.5	20.0	10.0	3.5	14.0	8.0	1.317
SO 31124-12-3/8	168.1161.390	10	16x1.0	19	17	42.5	23.0	23.5	10.0	4.0	15.0	8.0	1.632

Einbauempfehlung:

Conseil de montage:

Recommendation for installation:

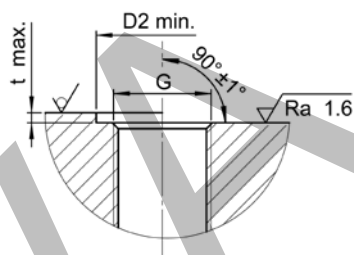

Gerade Einschraubverschraubung

mit O-Ringabdichtung (NBR)

Union mâle

avec joint torique (NBR)

Male adaptor union

with O-Ring seal (NBR)

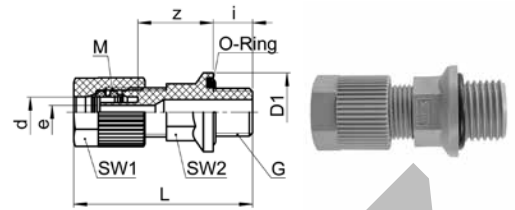

SO 31124 OR

Type -d-G	Mat.-Nr.	bar +	M	SW1	SW2	L	D1	D2	i	t	O-Ring	z	e	kg/100
G=Rohrgewinde (zylindrisch)				G=Filetage-gaz BSP (cylindrique)					G=BSP thread (parallel)					
SO 31124-6-1/8 OR	168.1171.100	10	10x1.0	12	10	34.5	16.0	16.5	8.5	3.5	9.25x1.78	15.0	2.8	0.378
SO 31124-6-1/4 OR	168.1171.110	10	10x1.0	12	13	36.5	19.5	20.0	10.0	3.5	12.42x1.78	15.5	2.8	0.482
SO 31124-6-3/8 OR	168.1171.120	10	10x1.0	12	17	37.5	23.5	24.0	10.0	3.5	15.6x1.78	16.5	2.8	0.695
SO 31124-8-1/8 OR	168.1171.160	10	12x1.0	14	10	36.5	16.0	16.5	8.0	3.5	9.25x1.78	15.5	4.7	0.462
SO 31124-8-1/4 OR	168.1171.170	10	12x1.0	14	13	38.5	19.5	20.0	10.0	3.5	12.42x1.78	15.5	4.8	0.557
SO 31124-8-3/8 OR	168.1171.180	10	12x1.0	14	17	39.5	23.5	24.0	10.0	3.5	15.6x1.78	16.5	4.8	0.758
SO 31124-10-1/4 OR	168.1171.270	10	14x1.0	17	13	39.0	19.5	20.0	10.0	3.5	12.42x1.78	15.0	6.6	0.737
SO 31124-10-3/8 OR	168.1171.280	10	14x1.0	17	17	40.0	23.5	24.0	10.0	3.5	15.6x1.78	16.0	6.6	0.924
SO 31124-10-1/2 OR	168.1171.285	10	14x1.0	17	19	45.0	30.0	31.0	12.0	5.5	20.29x2.62	19.0	6.6	1.210
SO 31124-12-1/4 OR	168.1171.380	10	16x1.0	19	13	41.5	19.5	20.0	10.0	3.5	12.42x1.78	14.0	8.0	0.897
SO 31124-12-3/8 OR	168.1171.390	10	16x1.0	19	17	42.5	23.5	24.0	10.0	3.5	15.6x1.78	15.0	8.0	1.092
SO 31124-12-1/2 OR	168.1171.400	10	16x1.0	19	19	47.5	29.5	30.5	12.0	5.5	20.29x2.62	18.0	8.0	1.376

Einbauempfehlung:

Conseil de montage:

Recommendation for installation:

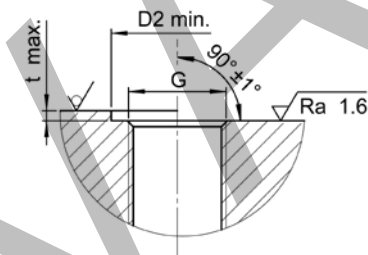

Einsatztemperaturbereich: -30 °C bis +80 °C

Die Vorteile dieser O-Ringabdichtung:

- keine Dichtmittelreste in Geräten
- einwandfreie Abdichtung
- keine Beschädigung von Geräten durch konische Gewinde
- schnelle Montage

Plage de température de service: -30 °C à +80 °C

Les avantages de cette étanchéité à joint torique:

- aucun reste de scellant dans les équipements
- une étanchéité parfaite
- aucun endommagement de l'équipement par le filetage conique
- facilité d'installation

Operating temperature range: -30 °C to +80 °C

Advantages of this O-ring seal:

- no sealing residues in devices
- perfect seal
- no damage to devices due to tapered thread
- rapid assembly

d=Rohrø / mit Wandung 1 mm

e=kleinste Bohrung

L=Mass in montiertem Zustand

d=ø extérieur du tube / avec paroi de 1 mm

e=ø-min. de passage

L=après montage

d=tube outside diameter / with wall thickness 1 mm

e=minimum bore

L=installed length

Gerade Einschraubverschraubung UNJF

mit O-Ringabdichtung (NBR)

Union mâle UNJF

avec joint torique (NBR)

Male adapter union UNJF

with O-Ring seal (NBR)

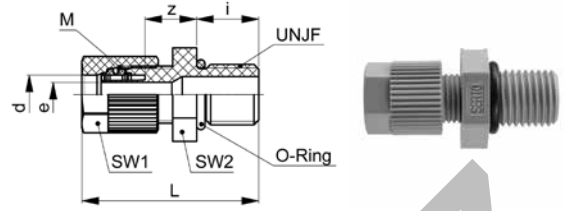

SO 31124 OR UNJF

Type -d-UNJF	Mat.-Nr.	bar +	M	SW1	SW2	L	D	i	t	O-Ring	z	e	kg/100
UNJF=Feingewinde (zylindrisch)			UNJF=Filetage fin (cylindrique)										
UNJF=Fine thread (parallel)													
SO 31124-6-7/16 UNJF OR	168.1178.122	10	10x1.0	12	17	35.0	21.0	13.0	1.0	9.25x1.78	11.0	2.8	0.500
SO 31124-6-3/8 UNJF OR	168.1178.126	10	10x1.0	12	17	35.0	21.0	13.0	1.0	12.0x2.0	11.0	2.8	0.500

Einbauempfehlung:

Conseil de montage:

Recommendation for installation:

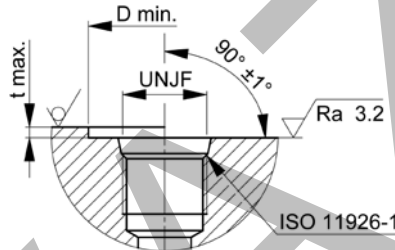

Einsatztemperaturbereich: -30°C bis +80°C

Plage de température de service: -30°C à +80°C

Operating temperature range: -30°C to +80°C

d=Rohraussen-ø / mit Wandung 1 mm
e=kleinste Bohrung
L=Mass in montiertem Zustand

d=ø extérieur du tube / avec paroi de 1 mm
e=ø-min. de passage
L=après montage

d=tube outside diameter / with wall thickness 1 mm
e=minimum bore
L=installed length

Gerade Aufschraubverschraubung Union femelle Female adaptor union

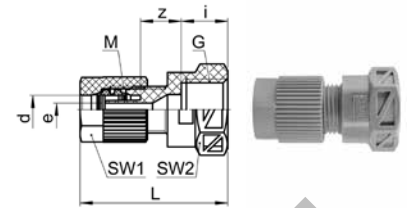

SO 31221

Type -d -G	Mat.-Nr.	bar +	M	SW1	SW2	L	i	z	e	kg/100
G=Rohrgewinde (zylindrisch)	G=Filetage-gaz BSP (cylindrique)	G=BSP thread (parallel)								
SO 31221-6-1/8	168.1201.100	10	10x1.0	12	14	29.0	9.0	9.0	2.8	0.309
SO 31221-6-1/4	168.1201.110	10	10x1.0	12	17	30.0	10.0	9.0	2.8	0.379
SO 31221-6-3/8	168.1201.120	10	10x1.0	12	22	31.0	11.0	9.0	2.8	0.526
SO 31221-6-1/2	168.1201.125	10	10x1.0	12	27	34.5	14.0	9.5	2.8	0.864
SO 31221-8-1/8	168.1201.160	10	12x1.0	14	14	31.0	9.0	9.0	4.8	0.376
SO 31221-8-1/4	168.1201.170	10	12x1.0	14	17	32.0	10.0	9.0	4.8	0.453
SO 31221-8-3/8	168.1201.180	10	12x1.0	14	22	33.0	11.0	9.0	4.8	0.587
SO 31221-8-1/2	168.1201.185	10	12x1.0	14	27	36.5	14.5	9.0	4.8	0.938
SO 31221-10-1/4	168.1201.270	10	14x1.0	17	17	32.5	10.0	8.5	6.6	0.602
SO 31221-10-3/8	168.1201.280	10	14x1.0	17	22	33.5	11.0	8.5	6.6	0.742
SO 31221-10-1/2	168.1201.285	10	14x1.0	17	27	37.0	14.0	9.0	6.6	1.074
▼ SO 31221-10-7/16	168.1201.320	10	14x1.0	17	17	32.5	10.0	8.5	5.6	0.615
▼ SO 31221-10-7-3/8	168.1201.330	10	14x1.0	17	22	33.5	11.0	8.5	5.6	0.755
SO 31221-12-3/8	168.1201.390	10	16x1.0	19	22	36.0	11.0	7.5	8.0	0.883
SO 31221-12-1/2	168.1201.400	10	16x1.0	19	27	39.5	14.0	8.0	8.0	1.234
▼ SO 31221-12-9-3/8	168.1201.412	10	16x1.0	19	22	36.0	11.0	7.5	7.0	0.908
▼ SO 31221-12-9-1/2	168.1201.414	10	16x1.0	19	27	39.5	14.0	8.0	7.0	1.253

Gerade Aufschraubverschraubung UNJF Union femelle UNJF Female adaptor union UNJF

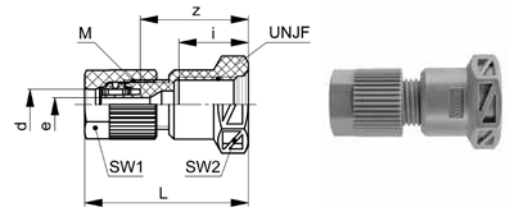

SO 31221 UNJF

Type -d -UNJF	Mat.-Nr.	bar +	M	SW1	SW2	L	i	z	e	kg/100
UNJF=Feingewinde (zylindrisch)	UNJF=Filetage fin (cylindrique)	UNJF=Fine thread (parallel)								
SO 31221-6-7/16 UNJF	168.1205.122	10	10x1.0	12	17	33.0	14.0	22.0	2.8	0.400
SO 31221-6-9/16 UNJF	168.1205.126	10	10x1.0	12	22	34.0	14.0	23.0	2.8	0.700

d=Rohrassen- \varnothing / mit Wandung 1 mm
e=kleinste Bohrung
L=Mass in montiertem Zustand
▼=für Rohre mit Wandung 1,5 mm

d= \varnothing extérieur du tube / avec paroi de 1 mm
e= \varnothing -min. de passage
L=après montage
▼=pour tubes avec paroi de 1,5 mm d'épaisseur

d=tube outside diameter / with wall thickness 1 mm
e=minimum bore
L=installed length
▼=for tubes with wall thickness of 1,5 mm

Verbindungsrippel

Pièce folle

Tube stub

SO 31300

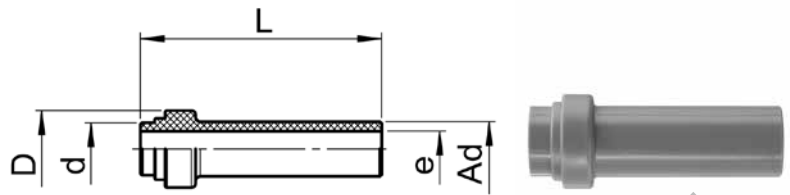

Type -d -Ad	Mat.-Nr.	bar +	L	D	e	kg/100
SO 31300-6-A6	166.1300.060	10	27.0	8.7	4.0	0.060
SO 31300-8-A8	166.1300.080	10	28.0	10.8	6.0	0.085
SO 31300-10-A10	166.1300.100	10	33.5	12.8	8.0	0.127
SO 31300-12-A12	166.1300.120	10	37.5	14.7	10.0	0.171
▼ SO 31300-12/9-A12	166.1300.122	10	37.0	14.7	9.0	0.233

Verbindungsrippel reduziert

Pièce folle réduite

Tube stub reduced

SO 31300 RED

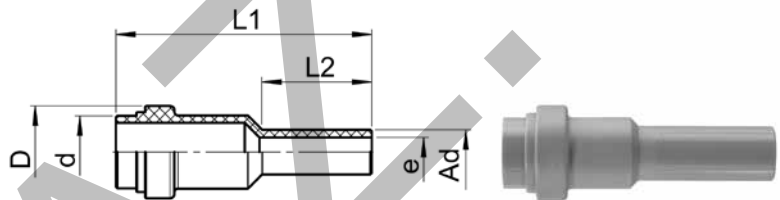

Type -d -Ad	Mat.-Nr.	bar +	L1	L2	D	e	kg/100
SO 31300-8-A6 RED	166.1304.140	10	30.0	15.0	10.8	4.0	0.080
SO 31300-10-A6 RED	166.1304.175	10	35.0	15.0	12.8	4.0	0.113
SO 31300-10-A8 RED	166.1304.190	10	35.0	15.0	12.8	6.0	0.124
SO 31300-12-A8 RED	166.1304.225	10	39.5	19.0	14.7	6.0	0.150
SO 31300-12-A10 RED	166.1304.240	10	39.0	19.0	14.7	8.0	0.166

Anwendungsbeispiele:

Exemples d'utilisation:

Sample combinations:

Werden die Verbindungsrippel mit einer Anschlussmutter und einem Armaturenanschluss (Anschlussmutter und Klemmring) verbunden, ergibt dies eine einstellbare Verschraubung.

Montagehinweis: Auf Seite des angedrehten Klemmrings (links im Bild) Anschlussmutter mit 1/4 Umdrehung anziehen. Auf Seite des Armaturenanschlusses (rechts im Bild) Anschlussmutter mit 1 3/4 Umdrehung anziehen.

Empfehlung: Für die einfache und korrekte Platzierung des Klemmrings die Montagehilfe AC 870 verwenden.

Si l'insert de la pièce folle est relié à un écrou et à un écrou de raccordement (écrou et bague de serrage), cela fournit une union orientable.

Note d'installation: Serrez l'écrou sur le côté de la bague de serrage tournée (à gauche sur l'illustr.) de 1/4 de tour. Serrez l'écrou de l'autre côté (à droite sur l'illustr.) de 1 3/4 tour.

Recommendation: Pour un positionnement facile et correct de la bague de serrage, utiliser l'aide au montage AC 870.

If the tube stubs are coupled with a union nut and a nut connection (union nut and compression ferrule), an adjustable union is produced.

Assembly information: Tighten the union nut on the side of the turned compression ferrule (left in pict.) with 1/4 turn. Tighten the union nut on the other side (right in pict.) 1 3/4 turns.

Recommendation: For easy and correct placement of the compression ferrule, use the assembly aid AC 870.

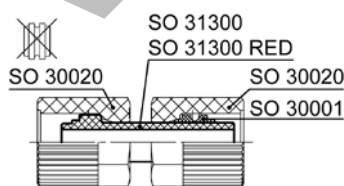

Fortsetzung nächste Seite

Suite à la prochaine page

Continued on next page

d=Rohrassen- \varnothing / mit Wandung 1 mm
Ad=Aussen- \varnothing der Andrehung
e=kleinste Bohrung
▼=für Rohre mit Wandung 1,5 mm

d= \varnothing extérieur du tube / avec paroi de 1 mm
Ad= \varnothing extérieur de la portée cylindrique
e= \varnothing -min. de passage
▼=pour tubes avec paroi de 1,5 mm d'épaisseur

d=tube outside diameter / with wall thickness 1 mm
Ad=outside diameter of cyl. stub
e=minimum bore
▼=for tubes with wall thickness of 1,5 mm

Anwendungsbeispiele:

Exemples d'utilisation:

Sample combinations:

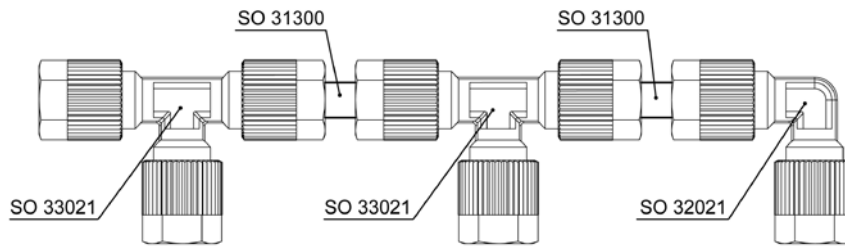

Mit der einstellbaren Verschraubung lassen sich Formteile mit dem gleichen Anschlussgewinde verbinden.

Avec l'union orientable, il est possible de connecter des raccords de même filetages.

With the adjustable union, parts with the same connecting thread can be connected.

KROVAVANZ.COM

d=Rohraussen- \varnothing / mit Wandung 1 mm
 Ad=Aussen- \varnothing der Andrehung
 e=kleinste Bohrung
 ▼=für Rohre mit Wandung 1,5 mm

d= \varnothing extérieur du tube / avec paroi de 1 mm
 Ad= \varnothing extérieur de la portée cylindrique
 e= \varnothing -min. de passage
 ▼=pour tubes avec paroi de 1,5 mm d'épaisseur

d=tube outside diameter / with wall thickness 1 mm
 Ad=outside diameter of cyl. stub
 e=minimum bore
 ▼=for tubes with wall thickness of 1,5 mm

Gerade Schottverschraubung

Durchführungslänge max. 6 mm

Union double traversée de cloison

pour cloison max. 6 mm

Panel mount union

max. panel thickness 6 mm

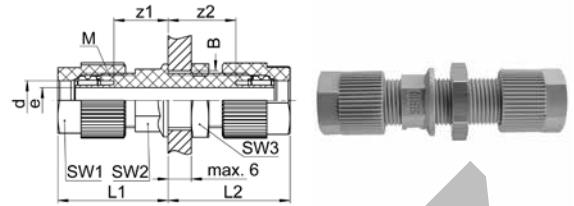

SO 31521

Type-d	Mat.-Nr.	bar +	M	SW1	SW2	SW3	L1	L2	B	z1	z2	e	kg/100
SO 31521-6	168.1500.060	10	10x1.0	12	14	14	24.0	28.0	10.5	13.0	17.0	2.8	0.678
SO 31521-8	168.1500.080	10	12x1.0	14	12	17	27.0	31.0	12.5	14.0	18.0	4.8	0.938
SO 31521-10	168.1500.100	10	14x1.0	17	14	19	28.0	32.0	14.5	14.0	18.0	6.6	1.387
▼ SO 31521-107	168.1500.102	10	14x1.0	17	14	19	28.0	31.5	14.5	14.0	17.5	5.6	1.417
SO 31521-12	168.1500.120	10	16x1.0	19	17	19	31.0	37.5	16.5	13.5	20.0	8.0	1.917
▼ SO 31521-129	168.1500.122	10	16x1.0	19	17	19	31.0	37.5	16.5	13.5	20.0	7.0	1.957

Sechskantmutter SO 40006 (Messing)

Ecrou à six pans SO 40006 (laiton)

Hexagon nut SO 40006 (brass)

d=Rohrassens- \varnothing / mit Wandung 1 mm
 e=kleinste Bohrung
 L=Mass in montiertem Zustand
 ▼=für Rohre mit Wandung 1,5 mm

d= \varnothing extérieur du tube / avec paroi de 1 mm
 e= \varnothing -min. de passage
 L=après montage
 ▼=pour tubes avec paroi de 1,5 mm d'épaisseur

d=tube outside diameter / with wall thickness 1 mm
 e=minimum bore
 L=installed length
 ▼=for tubes with wall thickness of 1,5 mm

Einstellnippel

Adaptateur orientable mâle

Adjustable male adaptor

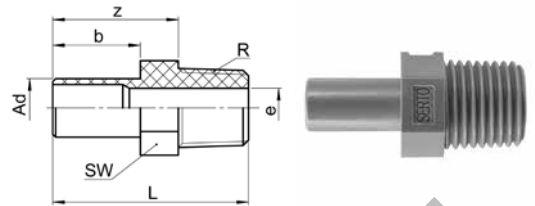

SO 31600

Type -Ad -R	Mat.-Nr.	bar +	SW	L	b	z	e	kg/100
R=Rohrgewinde (kegelig)								
			R=Filetage-gaz BSP (conique)					
						R=BSP thread (tapered)		
SO 31600-A6-1/8	166.1601.100	10	12	27.0	13.0	19.0	4.0	0.110
SO 31600-A6-1/4	166.1601.110	10	14	31.5	13.0	19.5	4.0	0.268
SO 31600-A6-3/8	166.1601.120	10	17	32.0	13.0	20.0	4.0	0.410
SO 31600-A8-1/8	166.1601.160	10	12	28.0	14.0	20.0	5.0	0.124
SO 31600-A8-1/4	166.1601.170	10	14	32.5	14.0	20.5	6.0	0.282
SO 31600-A8-3/8	166.1601.180	10	17	33.0	14.0	21.0	6.0	0.429
SO 31600-A10-1/4	166.1601.270	10	14	34.0	15.5	22.0	6.7	0.285
SO 31600-A10-3/8	166.1601.280	10	17	34.0	15.0	22.0	6.5	0.442
SO 31600-A10-1/2	166.1601.285	10	22	39.0	15.0	23.0	8.0	0.760
SO 31600-A12-1/4	166.1601.380	10	14	37.5	19.0	25.5	6.7	0.315
SO 31600-A12-3/8	166.1601.390	10	17	38.0	19.0	26.0	8.0	0.464
SO 31600-A12-1/2	166.1601.400	10	22	43.0	19.0	27.0	8.5	0.798

Empfehlung: Für die einfache und korrekte Platzierung des Klemmrings die Montagehilfe AC 870 verwenden.

Recommendation: Pour un positionnement facile et correct de la bague de serrage, utiliser l'aide au montage AC 870.

Recommendation: For easy and correct placement of the compression ferrule, use the assembly aid AC 870.

Anwendungsbeispiele:

Exemples d'utilisation:

Sample combinations:

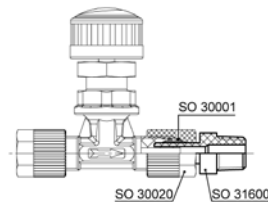
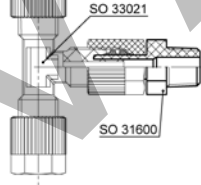
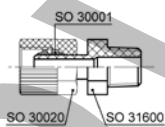

Mögliche Kombinationen:

- mit Armaturenanschluss zu einstellbaren Anschlüssen
- mit Verschraubungen/Ventilen zu einstellbaren Verschraubungen/Ventilen

Combinaisons possibles:

- avec écrou de raccordement ça donne des raccords orientables
- avec raccords/vannes ça donne des raccords/vannes orientables

Possible combinations:

- with nut connection to adjustable connections
- with unions/valves to adjustable unions/valves

Einstellnippel

mit O-Ringabdichtung (NBR)

Adaptateur orientable mâle

avec joint torique (NBR)

Adjustable male adaptor

with O-Ring seal (NBR)

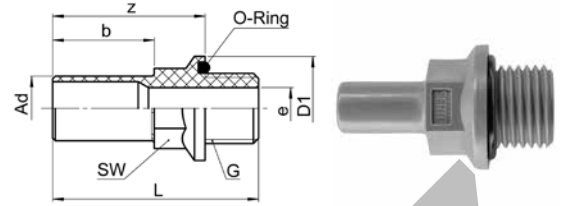
SO 31624 OR

Type -Ad -G	Mat.-Nr.	bar +	SW	L	D1	D2	b	O-Ring	t	z	e	kg/100
G=Rohrgewinde (zylindrisch)	G=Filetage-gaz BSP (cylindrique)	G=BSP thread (parallel)										
SO 31624-A6-1/8 OR	166.1681.100	10	10	30.5	16.0	16.5	13.0	9.25x1.78	3.5	22.5	4.0	0.175
SO 31624-A6-1/4 OR	166.1681.110	10	13	32.5	19.5	20.0	13.0	12.42x1.78	3.5	22.5	4.0	0.274
SO 31624-A6-3/8 OR	166.1681.120	10	17	33.5	23.5	24.0	13.0	15.6x1.78	3.5	23.5	4.0	0.470
SO 31624-A8-1/8 OR	166.1681.160	10	10	31.5	16.0	16.5	14.0	9.25x1.78	3.5	23.5	5.1	0.183
SO 31624-A8-1/4 OR	166.1681.170	10	13	33.5	19.5	20.0	14.0	12.42x1.78	3.5	23.5	6.0	0.287
SO 31624-A8-3/8 OR	166.1681.180	10	17	34.5	23.5	24.0	14.0	15.6x1.78	3.5	24.5	6.0	0.482
SO 31624-A10-1/4 OR	166.1681.270	10	13	34.5	19.5	20.0	15.0	12.42x1.78	3.5	24.5	8.0	0.298
SO 31624-A10-3/8 OR	166.1681.280	10	17	35.5	23.5	24.0	15.0	15.6x1.78	3.5	25.5	8.0	0.482
SO 31624-A10-1/2 OR	166.1681.285	10	19	40.5	30.0	31.0	15.0	20.63x2.62	5.5	28.5	8.0	0.768
SO 31624-A12-1/4 OR	166.1681.380	10	13	38.5	19.5	20.0	19.0	12.42x1.78	3.5	28.5	6.6	0.326
SO 31624-A12-3/8 OR	166.1681.390	10	17	39.5	23.5	24.0	19.0	15.6x1.78	3.5	29.5	10.0	0.511
SO 31624-A12-1/2 OR	166.1681.400	10	19	44.5	30.0	31.0	19.0	20.63x2.62	5.5	32.5	10.0	0.794

Einsatztemperaturbereich: -30 °C bis +80 °C

Plage de température de service: -30 °C à +80 °C

Operating temperature range: -30 °C to +80 °C

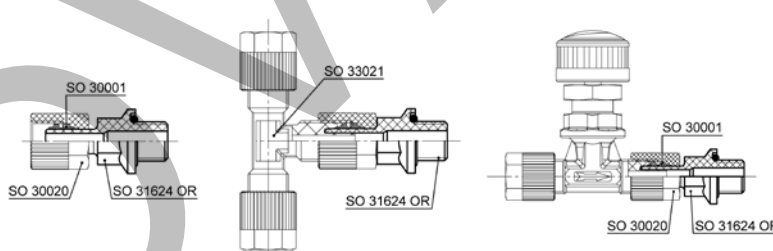
Empfehlung: Für die einfache und korrekte Platzierung des Klemmrings die Montagehilfe AC 870 verwenden.**Recommendation:** Pour un positionnement facile et correct de la bague de serrage, utiliser l'aide au montage AC 870.**Recommendation:** For easy and correct placement of the compression ferrule, use the assembly aid AC 870.**Anwendungsbeispiele:****Exemples d'utilisation:****Sample combinations:**

Mögliche Kombinationen:

- mit Armaturenanschluss zu einstellbaren Anschlüssen
- mit Verschraubungen/Ventilen zu einstellbaren Verschraubungen/Ventilen

Combinaisons possibles:

- avec écrou de raccordement ça donne des raccords orientables
- avec raccords/vannes ça donne des raccords/vannes orientables

Possible combinations:

- with nut connection to adjustable connections
- with unions/valves to adjustable unions/valves

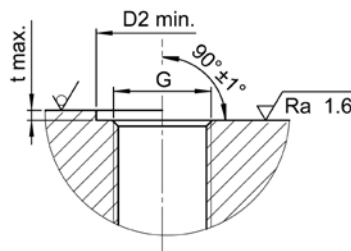
Einbauempfehlung:**Conseil de montage:****Recommendation for installation:**Ad=Aussen-Ø der Andrehung
e=kleinste BohrungAd=Ø extérieur de la portée cylindrique
e=Ø-min. de passageAd=outside diameter of cyl. stub
e=minimum bore

Einstellnippel UNJF

mit O-Ringabdichtung (NBR)

Adaptateur orientable mâle UNJF

avec joint torique (NBR)

Adjustable male adaptor UNJF

with O-Ring seal (NBR)

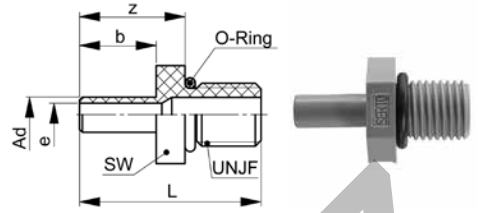

SO 31624 OR UNJF

Type -Ad -UNJF	Mat.-Nr.	bar +	SW	L	D	b	t	O-Ring	z	e	kg/100
UNJF=Feingewinde (zylindrisch)	UNJF=Filetage fin (cylindrique)	UNJF=Fine thread (parallel)									
SO 31624-A6-7/16 UNJF OR	166.1685.122	10	17	31.5	21.0	13.0	1.0	9.25x1.78	18.5	4.0	0.300
SO 31624-A6-3/8 UNJF OR	166.1685.126	10	17	31.5	21.0	13.0	1.0	12.0x2.0	18.5	4.0	0.350

Einsatztemperaturbereich: -30°C bis +80°C

Plage de température de service: -30°C à +80°C

Operating temperature range: -30°C to +80°C

Empfehlung: Für die einfache und korrekte Platzierung des Klemmrings die Montagehilfe AC 870 verwenden.

Recommendation: Pour un positionnement facile et correct de la bague de serrage, utiliser l'aide au montage AC 870.

Recommendation: For easy and correct placement of the compression ferrule, use the assembly aid AC 870.

Einbauempfehlung:

Conseil de montage:

Recommendation for installation:

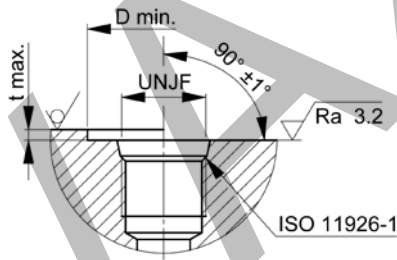

Reduktions-Einstellverschraubung

Raccord de réduction orientable

Adjustable reduction union

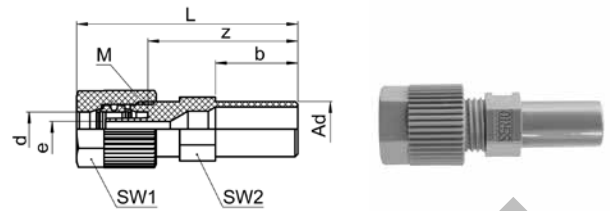

SO 31821

Type -Ad -d	Mat.-Nr.	bar +	M	SW1	SW2	L	b	z	e	kg/100
SO 31821-A8-6	168.1800.140	10	10x1.0	12	10	37.5	14.5	26.5	2.8	0.301
SO 31821-A10-6	168.1800.175	10	10x1.0	12	10	39.0	15.5	28.0	2.8	0.308
SO 31821-A10-8	168.1800.190	10	12x1.0	14	12	41.5	15.5	28.5	4.8	0.415
SO 31821-A12-6	168.1800.215	10	10x1.0	12	10	50.0	20.0	32.5	2.8	0.348
SO 31821-A12-8	168.1800.225	10	12x1.0	14	12	50.0	19.5	32.5	4.8	0.436
SO 31821-A12-10	168.1800.240	10	14x1.0	17	14	49.5	19.5	32.0	6.6	0.500
▼ SO 31821-A12-10/7	168.1800.242	10	14x1.0	17	14	49.0	19.0	31.5	5.6	0.667

Empfehlung: Für die einfache und korrekte Platzierung des Klemmrings die Montagehilfe AC 870 verwenden.

Recommendation: Pour un positionnement facile et correct de la bague de serrage, utiliser l'aide au montage AC 870.

Recommendation: For easy and correct placement of the compression ferrule, use the assembly aid AC 870.

Anwendungsbeispiele:

Exemples d'utilisation:

Sample combinations:

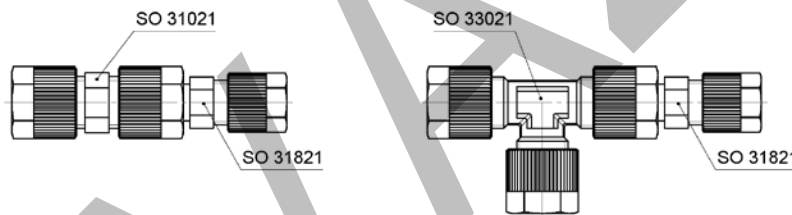

Mit dieser Reduktion können Verschraubungen reduziert werden.

Cette réduction permet de réduire les raccords.

Unions can be reduced with this reduction.

d=Rohrussen- \varnothing / mit Wandung 1 mm
 Ad=Aussen- \varnothing der Andrehung
 e=kleinste Bohrung
 L=Mass in montiertem Zustand
 ▼=für Rohre mit Wandung 1,5 mm

d= \varnothing extérieur du tube / avec paroi de 1 mm
 Ad= \varnothing extérieur de la portée cylindrique
 e= \varnothing -min. de passage
 L=après montage
 ▼=pour tubes avec paroi de 1,5 mm d'épaisseur

d=tube outside diameter / with wall thickness 1 mm
 Ad=outside diameter of cyl. stub
 e=minimum bore
 L=installed length
 ▼=for tubes with wall thickness of 1,5 mm

Winkelverschraubung

Coude

Elbow union

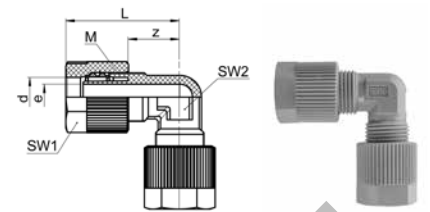

SO 32021

Type -d	Mat.-Nr.	bar +	M	SW1	SW2	L	z	e	kg/100
SO 32021-6	168.2000.060	10	10x1.0	12	8	25.0	14.0	2.8	0.546
SO 32021-8	168.2000.080	10	12x1.0	14	10	27.5	14.5	4.8	0.743
SO 32021-10	168.2000.100	10	14x1.0	17	12	30.0	16.0	6.6	1.178
▼ SO 32021-10/7	168.2000.102	10	14x1.0	17	12	30.0	16.0	7.0	1.209
SO 32021-12	168.2000.120	10	16x1.0	19	13	33.5	16.0	8.0	1.545
▼ SO 32021-12/9	168.2000.122	10	16x1.0	19	13	33.5	16.0	7.0	1.580

d=Rohrassen- \varnothing / mit Wandung 1 mm
 e=kleinste Bohrung
 L=Mass in montiertem Zustand
 ▼=für Rohre mit Wandung 1,5 mm

d= \varnothing extérieur du tube / avec paroi de 1 mm
 e= \varnothing -min. de passage
 L=après montage
 ▼=pour tubes avec paroi de 1,5 mm d'épaisseur

d=tube outside diameter / with wall thickness 1 mm
 e=minimum bore
 L=installed length
 ▼=for tubes with wall thickness of 1,5 mm

Winkel-Einschraubverschraubung Coude mâle Male adaptor elbow union

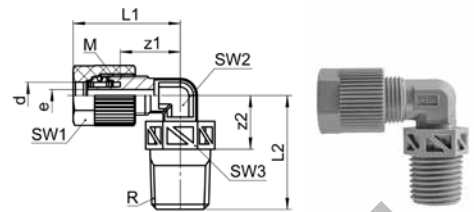

SO 32421

Type -d -R	Mat.-Nr.	bar +	M	SW1	SW2	SW3	L1	L2	z1	z2	e	kg/100
R=Rohrgewinde (kegelig)	R=Filetage-gaz BSP (conique)	R=BSP thread (tapered)										
SO 32421-6-1/8	168.2401.100	10	10x1.0	12	8	10	25.0	19.0	14.0	11.0	2.8	0.387
SO 32421-6-1/4	168.2401.110	10	10x1.0	12	8	14	25.0	24.5	14.0	12.5	2.8	0.528
SO 32421-8-1/8	168.2401.160	10	12x1.0	14	10	10	27.5	20.0	14.5	12.0	4.8	0.499
SO 32421-8-1/4	168.2401.170	10	12x1.0	14	10	14	27.5	25.5	14.5	13.5	4.8	0.640
SO 32421-10-1/4	168.2401.270	10	14x1.0	17	12	14	30.0	26.5	16.0	14.5	6.6	0.877
SO 32421-10-3/8	168.2401.280	10	14x1.0	17	12	17	30.0	27.0	16.0	15.0	6.6	1.016
▼ SO 32421-107-1/4	168.2401.320	10	14x1.0	17	12	14	30.0	26.5	16.0	14.5	5.6	0.892
▼ SO 32421-107-3/8	168.2401.330	10	14x1.0	17	12	17	30.0	27.0	16.0	15.0	5.6	1.031
SO 32421-12-1/4	168.2401.380	10	16x1.0	19	13	14	33.5	27.5	16.0	15.5	6.7	1.080
SO 32421-12-3/8	168.2401.390	10	16x1.0	19	13	17	33.5	28.0	16.0	16.0	8.0	1.207
SO 32421-12-1/2	168.2401.400	10	16x1.0	19	13	22	33.5	35.5	16.0	19.5	8.0	1.574
▼ SO 32421-129-1/4	168.2401.410	10	16x1.0	19	13	14	33.5	27.5	16.0	15.5	6.7	1.098
▼ SO 32421-129-3/8	168.2401.412	10	16x1.0	19	13	17	33.5	28.0	16.0	16.0	7.0	1.224
▼ SO 32421-129-1/2	168.2401.414	10	16x1.0	19	13	22	33.5	35.5	16.0	19.5	7.0	1.607

Winkel-Einschraubverschraubung NPT Coude mâle NPT Male adaptor elbow union NPT

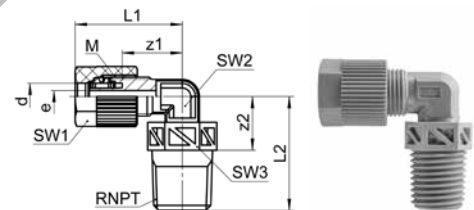

SO 32421 NPT

Type -d -RNPT	Mat.-Nr.	bar +	M	SW1	SW2	SW3	L1	L2	z1	z2	e	kg/100
RNPT=NPT Gewinde	RNPT=Filetage NPT	RNPT=NPT thread										
SO 32421-6-1/8 NPT	168.2402.100	10	10x1.0	12	8	11	25.0	21.0	14.0	11.0	2.8	0.419
SO 32421-6-1/4 NPT	168.2402.110	10	10x1.0	12	8	14	25.0	26.5	14.0	12.5	2.8	0.559
SO 32421-8-1/8 NPT	168.2402.160	10	12x1.0	14	10	11	27.5	22.0	14.5	12.0	4.8	0.532
SO 32421-8-1/4 NPT	168.2402.170	10	12x1.0	14	10	14	27.5	27.5	14.5	13.5	4.8	0.672
SO 32421-10-1/4 NPT	168.2402.270	10	14x1.0	17	12	14	30.0	28.5	16.0	14.5	6.6	0.905
SO 32421-10-3/8 NPT	168.2402.280	10	14x1.0	17	12	17	30.0	29.0	16.0	15.0	6.6	1.057
▼ SO 32421-107-1/4 NPT	168.2402.320	10	14x1.0	17	12	14	30.0	28.5	16.0	14.5	5.6	0.920
▼ SO 32421-107-3/8 NPT	168.2402.330	10	14x1.0	17	12	17	30.0	29.0	16.0	15.0	5.6	1.072

d=Rohrassen- \varnothing / mit Wandung 1 mm
e=kleinste Bohrung
L=Mass in montiertem Zustand
▼=für Rohre mit Wandung 1,5 mm

d= \varnothing extérieur du tube / avec paroi de 1 mm
e= \varnothing -min. de passage
L=après montage
▼=pour tubes avec paroi de 1,5 mm d'épaisseur

d=tube outside diameter / with wall thickness 1 mm
L=installed length
e=minimum bore
▼=for tubes with wall thickness of 1,5 mm

Einstellbare Winkelverschraubung

Coude orientable

Adjustable elbow union

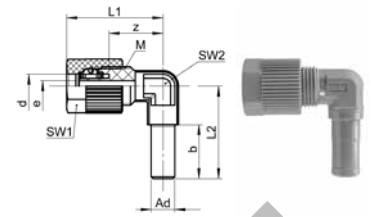

SO 32621

Type -d -Ad	Mat.-Nr.	bar +	M	SW1	SW2	L1	L2	b	z	e	kg/100
SO 32621-6-A6	168.2600.060	10	10x1.0	12	8	25.0	24.0	14.0	14.0	2.8	0.353
SO 32621-8-A8	168.2600.080	10	12x1.0	14	10	27.5	25.0	16.0	14.5	4.8	0.486
SO 32621-10-A10	168.2600.100	10	14x1.0	17	12	30.0	29.0	18.0	16.0	6.6	0.755
SO 32621-12-A12	168.2600.120	10	16x1.0	19	13	33.5	32.0	21.0	16.0	8.0	0.983

Empfehlung: Für die einfache und korrekte Platzierung des Klemmrings die Montagehilfe AC 870 verwenden.

Recommendation: Pour un positionnement facile et correct de la bague de serrage, utiliser l'aide au montage AC 870.

Recommendation: For easy and correct placement of the compression ferrule, use the assembly aid AC 870.

Anwendungsbeispiele:

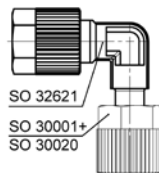

Exemples d'utilisation:

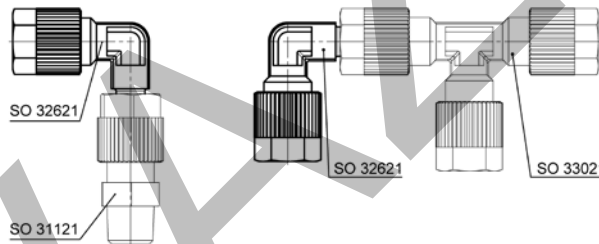

Sample combinations:

Mögliche Kombinationen:

- mit Armaturenanschluss zu einstellbaren Winkelverschraubungen
- mit Verschraubungen zu einstellbaren Verschraubungen
- mit Einschraubverschraubungen zu einstellbaren Einschraubwinkeln. Gegenüber dem Einschraubwinkel lässt sich diese Kombination einfacher einstellen, da Einschrauben und Ausrichten getrennt voneinander vorgenommen werden.

Combinaisons possibles:

- avec écrou de raccordement ça donne des raccords coudé orientables
- avec raccords ça donne des raccords orientables
- avec une union mâle ça donne un coude fileté orientable. Par rapport au coude orientable, cette combinaison est facile à régler, puisque le vissage et l'alignement sont réalisés séparément l'un de l'autre.

Possible combinations:

- with a nut connection to adjustable elbow unions
- with a union to adjustable unions
- with a male adaptor union to adjustable male adaptor elbow unions. This combination is simpler to produce, as screwing in and alignment are carried out separately.

d=Rohrassen- \varnothing / mit Wandung 1 mm
 Ad=Aussen- \varnothing der Andrehung
 e=kleinste Bohrung
 L=Mass in montiertem Zustand

d= \varnothing extérieur du tube / avec paroi de 1 mm
 Ad= \varnothing extérieur de la portée cylindrique
 e= \varnothing -min. de passage
 L=après montage

d=tube outside diameter / with wall thickness 1 mm
 Ad=outside diameter of cyl. stub
 e=minimum bore
 L=installed length

Winkelschottverschraubung

Durchführungslänge max. 6 mm

Coude traversée de cloison

pour cloison max. 6 mm

Panel mount elbow union

max. panel thickness 6 mm

SO 32721

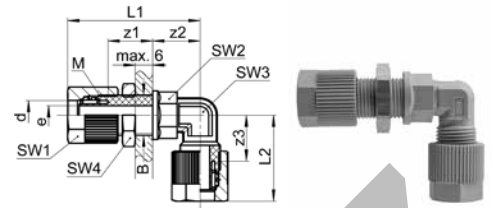

Type -d	Mat.-Nr.	bar +	M	SW1	SW2	SW3	SW4	L1	L2	B	z1	z2	z3	e	kg/100
SO 32721-6	168.2700.060	10	10x1.0	12	10	8	14	39.5	25.0	10.5	15.5	13.0	14.0	2.8	1.234
SO 32721-8	168.2700.080	10	12x1.0	14	12	10	17	43.0	27.5	12.5	15.0	15.0	14.5	4.8	1.040
SO 32721-10	168.2700.100	10	14x1.0	17	14	12	19	46.0	30.0	14.5	15.5	16.5	16.0	6.6	1.490
SO 32721-12	168.2700.120	10	16x1.0	19	17	13	19	48.5	33.5	16.5	13.5	17.5	16.0	8.0	2.000

Sechskantmutter SO 40006 (Messing)

Ecrou à six pans SO 40006 (laiton)

Hexagon nut SO 40006 (brass)

d=Rohrassen- \varnothing / mit Wandung 1 mm
Ad=Aussen- \varnothing der Andrehung
e=kleinste Bohrung
L=Mass in montiertem Zustand

d= \varnothing extérieur du tube / avec paroi de 1 mm
Ad= \varnothing extérieur de la portée cylindrique
e= \varnothing -min. de passage
L=après montage

d=tube outside diameter / with wall thickness 1 mm
Ad=outside diameter of cyl. stub
e=minimum bore
L=installed length

Schwenkverschraubung
Coude banjo
Single banjo

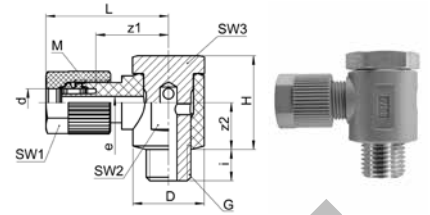

SO 32821

Type -d -G	Mat.-Nr.	bar	M	SW1	SW2	SW3	L	D	H	i	z1	z2	e	kg/100
G=Rohrgewinde (zylindrisch)				G=Filetage-gaz BSP (cylindrique)							G=BSP thread (parallel)			
SO 32821-6-1/8	168.2841.100	10	10x1.0	12	14	14	27.5	16.0	21.0	7.0	16.5	10.5	2.8	1.950
SO 32821-6-1/4	168.2841.110	10	10x1.0	12	19	19	27.5	20.0	26.0	10.0	16.5	12.5	2.8	4.080
SO 32821-8-1/8	168.2841.160	10	12x1.0	14	14	14	29.5	16.0	21.0	7.0	16.5	10.5	3.8	2.040
SO 32821-8-1/4	168.2841.170	10	12x1.0	14	19	19	29.5	20.0	26.0	10.0	16.5	12.5	4.8	4.160
SO 32821-10-1/4	168.2841.270	10	14x1.0	17	19	19	30.0	20.0	26.0	10.0	16.0	12.5	6.5	4.360
▼ SO 32821-10/7-1/4	168.2841.320	10	14x1.0	17	19	19	30.0	20.0	26.0	10.0	16.0	12.5	5.6	4.450

Hohlschraube aus Messing

Vis banjo en laiton

Hollow screw of brass

Schwenkverschraubung METR
Coude banjo METR
Single banjo METR

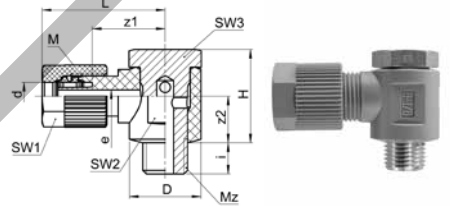

SO 32821 METR

Type -d -Mz	Mat.-Nr.	bar	M	SW1	SW2	SW3	L	D	H	i	z1	z2	e	kg/100
Mz=metrisches Gewinde (zylindrisch)				Mz=Filetage métrique (cylindrique)							Mz=Metric thread (parallel)			
SO 32821-6-M10x1	168.2843.180	10	10x1.0	12	14	14	27.5	16.0	21.0	7.0	16.5	10.5	2.8	1.960
SO 32821-6-M12x1,5	168.2843.195	10	10x1.0	12	19	19	27.5	20.0	27.0	9.0	16.5	12.5	2.8	4.050
SO 32821-6-M14x1,5	168.2843.198	10	10x1.0	12	19	19	27.5	20.0	27.0	9.0	16.5	12.5	2.8	4.050
SO 32821-8-M10x1	168.2843.230	10	12x1.0	14	14	14	29.5	16.0	21.0	7.0	16.5	10.5	3.8	2.040
SO 32821-8-M12x1,5	168.2843.240	10	12x1.0	14	19	19	29.5	20.0	27.0	9.0	16.5	12.5	4.8	4.130
SO 32821-8-M14x1,5	168.2843.245	10	12x1.0	14	19	19	29.5	20.0	27.0	9.0	16.5	12.5	4.8	4.160
SO 32821-10-M12x1,5	168.2843.275	10	14x1.0	17	19	19	30.0	20.0	27.0	9.0	16.0	12.5	6.5	4.320
SO 32821-10-M14x1,5	168.2843.280	10	14x1.0	17	19	19	30.0	20.0	27.0	9.0	16.0	12.5	6.5	4.340
▼ SO 32821-10/7-M12x1,5	168.2843.300	10	14x1.0	17	19	19	30.0	20.0	27.0	9.0	16.0	12.5	5.6	4.420
▼ SO 32821-10/7-M14x1,5	168.2843.305	10	14x1.0	17	19	19	30.0	20.0	27.0	9.0	16.0	12.5	5.6	4.430

Hohlschraube aus Messing

Vis banjo en laiton

Hollow screw of brass

d=Rohrassen-ø / mit Wandung 1 mm
 e=kleinste Bohrung
 L=Mass in montiertem Zustand
 ▼=für Rohre mit Wandung 1,5 mm

d=ø extérieur du tube / avec paroi de 1 mm
 e=ø min. de passage
 L=après montage
 ▼=pour tubes avec paroi de 1,5 mm d'épaisseur

d=tube outside diameter / with wall thickness 1 mm
 e=minimum bore
 L=installed length
 ▼=for tubes with wall thickness of 1,5 mm

Schwenkverschraubung

mit Drossel-Ventil

Coude banjo

avec limiteur de débit

Single banjo

with throttle valve

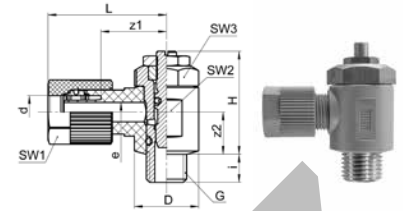
SO 37621

Type -d-G	Mat.-Nr.	bar	M	SW1	SW2	SW3	L	D	H	i	z1	z2	e	kv	kg/100
G=Rohrgewinde (zylindrisch)				G=Filetage-gaz BSP (cylindrique)							G=BSP thread (parallel)				
SO 37621-6-1/8	168.7600.100	10	10x1.0	12	14	14	27.5	16.0	25.0	7.0	16.5	10.5	2.8	3.0	2.100
SO 37621-6-1/4	168.7600.110	10	10x1.0	12	19	19	27.5	20.0	32.0	9.0	16.5	12.5	2.8	6.0	4.400
SO 37621-8-1/8	168.7600.160	10	12x1.0	14	14	14	29.5	16.0	25.5	7.0	16.5	10.5	4.8	3.0	2.800
SO 37621-8-1/4	168.7600.170	10	12x1.0	14	19	19	29.5	20.0	30.5	9.0	16.5	12.5	4.8	6.0	4.500
SO 37621-10-1/4	168.7600.270	10	14x1.0	17	19	19	30.0	20.0	30.5	9.0	16.0	12.5	6.6	6.0	4.600

Dieses Drossel-Ventil dient zur Regulierung von Luftströmen in beiden Richtungen. Die Kombination von Verschraubung und Drossel-Ventil erlaubt den Anbau direkt an einen passenden Zylinder.

Die Spindelfixierung mittels Kontermutter garantiert, dass sich die Spindel auch bei Vibration nicht verstellt.

Technische Hinweise:

Körper, Anschlussmutter: PA 6.6
O-Ringe: NBR
Hohlschraube, Ventileinsatz: Messing

Ce limiteur de débit sert au réglage d'écoulements d'air dans les deux sens. La combinaison raccord avec limiteur de débit est spécialement destinée au montage sur un cylindre approprié.

La fixation de la broche à l'aide d'un contre-écrou garantit la stabilité du réglage même en cas de vibrations.

Données techniques:

Corps, écrou de raccord: PA 6.6
Joints toriques: NBR
Vis banjo, parties de valve: laiton

This throttle valve serves to regulate air flow in both directions. The combination of union and throttle valve permits direct fitting to a matching cylinder.

The spindle fixation via counter nut assures that the spindle can not shift, even due to vibration.

Technical notes:

Body, union nut: PA 6.6
O-rings: NBR
Hollow screw, valve parts: brass

Schwenkverschraubung

mit Drossel-Rückschlagventil

Coude banjo

avec clapet anti-retour limiteur de débit

Single banjo

with throttle non-return valve

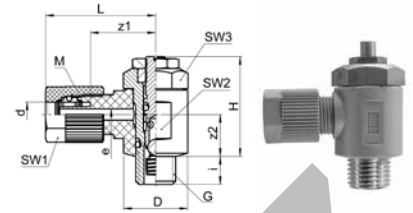
SO 37721

Type -d-G	Mat.-Nr.	bar	M	SW1	SW2	SW3	L	D	H	i	z1	z2	e	kv	kg/100	
G=Rohrgewinde (zylindrisch)				G=Filetage-gaz BSP (cylindrique)							G=BSP thread (parallel)					
SO 37721-6-1/8	168.7700.100	10	10x1.0	12	14	14	27.5	16.0	25.0	7.0	16.5	10.5	2.8	3.0	2.100	
SO 37721-6-1/4	168.7700.110	10	10x1.0	12	19	19	27.5	20.0	32.0	9.0	16.5	12.5	2.8	6.0	4.300	
SO 37721-8-1/8	168.7700.160	10	12x1.0	14	14	14	29.5	16.0	25.5	7.0	16.5	10.5	4.8	3.0	2.400	
SO 37721-8-1/4	168.7700.170	10	12x1.0	14	19	19	29.5	20.0	30.5	9.0	16.5	12.5	4.8	6.0	4.500	
SO 37721-10-1/4	168.7700.270	10	14x1.0	17	19	19	30.0	20.0	30.5	9.0	16.0	12.5	6.6	6.0	4.600	

Dieses Drossel-Rückschlagventil dient zur Regulierung von Luftströmen in der Anschlussrichtung. Die Kombination von Verschraubung und Ventil erlaubt den Anbau direkt an einen passenden Zylinder. Die Spindelfixierung mittels Kontermutter garantiert, dass sich die Spindel auch bei Vibration nicht verstellt.

Technische Hinweise:

Körper, Anschlussmutter: PA 6.6
O-Ringe: NBR
Hohlschraube, Ventileinsatz: Messing

Ce clapet anti-retour limiteur de débit sert au réglage d'écoulements d'air dans la sens de connexion. La combinaison raccord avec clapet est spécialement destinée au montage sur un cylindre approprié. La fixation de la broche à l'aide d'un contre-écrou garantit la stabilité du réglage même en cas de vibrations.

Données techniques:

Corps, écrou de raccord: PA 6.6
Joints toriques: NBR
Vis banjo, parties du clapet: laiton

This throttle non-return valve serves to regulate air flow in the direction of connection. The combination of union and valve permits direct fitting to a matching cylinder. The spindle fixation via counter nut assures that the spindle can not shift, even due to vibration.

Technical notes:

Body, union nut: PA 6.6
O-rings: NBR
Hollow screw, valve parts: brass

d=Rohrassens- \varnothing / mit Wandung 1 mm
e=kleinste Bohrung
kv=Kenngröße für das Durchflussverhalten (l/min)
L=Mass in montiertem Zustand

d= \varnothing extérieur du tube / avec paroi de 1 mm
e= \varnothing -min. de passage
kv=facteur d'écoulement (l/min)
L=après montage

d=tube outside diameter / with wall thickness 1 mm
e=minimum bore
kv=flow factor (l/min)
L=installed length

2-fach Winkel-Schwenkverschraubung

Coude banjo double

Double banjo

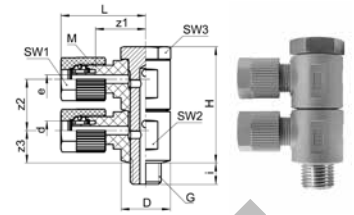
SO 32921

Type -d -G	Mat.-Nr.	bar	M	SW1	SW2	SW3	L	D	H	i	z1	z2	z3	e	kg/100
G=Rohrgewinde (zylindrisch)				G=Filetage-gaz BSP (cylindrique)							G=BSP thread (parallel)				
SO 32921-2x6-1/8	168.2941.100	10	10x1.0	12	14	14	27.5	16.0	37.5	7.0	16.5	16.0	10.5	2.8	3.080
SO 32921-2x6-1/4	168.2941.110	10	10x1.0	12	19	19	27.5	20.0	48.0	10.0	16.5	21.0	12.5	2.8	6.140
SO 32921-2x8-1/8	168.2941.160	10	12x1.0	14	14	14	29.5	16.0	37.5	7.0	16.5	16.0	10.5	3.8	3.260
SO 32921-2x8-1/4	168.2941.170	10	12x1.0	14	19	19	29.5	20.0	48.0	10.0	16.5	21.0	12.5	4.8	6.300
SO 32921-2x10-1/4	168.2941.270	10	14x1.0	17	19	19	30.0	20.0	48.0	10.0	16.0	21.0	12.5	6.5	6.700
▼ SO 32921-2x10-7/8	168.2941.320	10	14x1.0	17	19	19	30.0	20.0	48.0	10.0	16.0	21.0	12.5	5.6	6.810

KONVARI

d=Rohrassens-ø / mit Wandung 1 mm
 e=kleinste Bohrung
 L=Mass in montiertem Zustand
 ▼=für Rohre mit Wandung 1,5 mm

d=ø extérieur du tube / avec paroi de 1 mm
 e=ø min. de passage
 L=après montage
 ▼=pour tubes avec paroi de 1,5 mm d'épaisseur

d=tube outside diameter / with wall thickness 1 mm
 e=minimum bore
 L=installed length
 ▼=for tubes with wall thickness of 1,5 mm

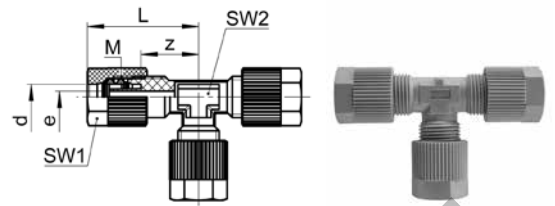
T-Verschraubung
Té égal
Tee union

SO 33021

Type -d	Mat.-Nr.	bar +	M	SW1	SW2	L	z	e	kg/100
SO 33021-6	168.3000.060	10	10x1.0	12	8	25.0	14.0	2.8	0.804
SO 33021-8	168.3000.080	10	12x1.0	14	10	27.5	14.5	4.8	1.089
SO 33021-10	168.3000.100	10	14x1.0	17	12	30.0	16.0	6.6	1.724
▼ SO 33021-10/7	168.3000.102	10	14x1.0	17	12	30.0	16.0	5.6	1.766
SO 33021-12	168.3000.120	10	16x1.0	19	13	33.5	16.0	8.0	2.267
▼ SO 33021-12/9	168.3000.122	10	16x1.0	19	13	33.5	16.0	7.0	2.313

d=Rohrassens- \varnothing / mit Wandung 1 mm
 e=kleinste Bohrung
 L=Mass in montiertem Zustand
 ▼=für Rohre mit Wandung 1,5 mm

d= \varnothing extérieur du tube / avec paroi de 1 mm
 e= \varnothing -min. de passage
 L=après montage
 ▼=pour tubes avec paroi de 1,5 mm d'épaisseur

d=tube outside diameter / with wall thickness 1 mm
 e=minimum bore
 L=installed length
 ▼=for tubes with wall thickness of 1,5 mm

Einstellbare T-Verschraubung

Té orientable au centre

Adjustable tee union

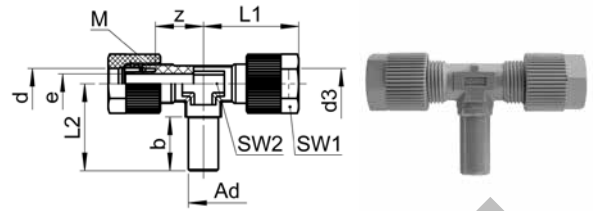

SO 33621

Type -d -Ad -d3	Mat.-Nr.	bar +	M	SW1	SW2	L1	L2	b	z	e	kg/100
SO 33621-6-A6-6	168.3600.060	10	10x1.0	12	8	25.0	24.0	14.0	14.0	2.8	0.618
SO 33621-8-A8-8	168.3600.080	10	12x1.0	14	10	27.5	25.0	16.0	14.5	4.8	0.850
SO 33621-10-A10-10	168.3600.100	10	14x1.0	17	12	30.0	29.0	18.0	16.0	6.6	1.304
SO 33621-12-A12-12	168.3600.120	10	16x1.0	19	13	33.5	30.0	21.0	16.0	8.0	1.715

Empfehlung: Für die einfache und korrekte Platzierung des Klemmrings die Montagehilfe AC 870 verwenden.

Recommendation: Pour un positionnement facile et correct de la bague de serrage, utiliser l'aide au montage AC 870.

Recommendation: For easy and correct placement of the compression ferrule, use the assembly aid AC 870.

Anwendungsbeispiele:

Exemples d'utilisation:

Sample combinations:

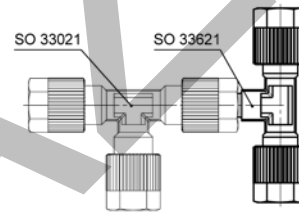
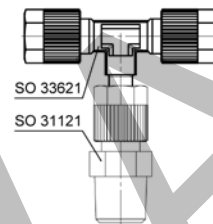
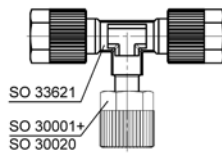

Mögliche Kombinationen:

- mit Armaturenanschluss zu einstellbaren T-Verschraubungen
- mit Verschraubungen zu einstellbaren Verschraubungen
- mit Einschraubverschraubungen zu einstellbaren T-Einschraubverschraubungen. Gegenüber der T-Einschraubverschraubung lässt sich diese Kombination einfacher einstellen, da Einschrauben und Ausrichten getrennt voneinander vorgenommen werden.

Combinaisons possibles:

- avec écrou de raccordement ça donne un Té orientable
- avec raccords ça donne des raccords orientables
- avec une union mâle ça donne un Té fileté orientable. Par rapport au Té orientable, cette combinaison est facile à régler, puisque le vissage et l'alignement sont réalisés séparément l'un de l'autre.

Possible combinations:

- with nut connections to adjustable tee unions
- with unions to adjustable unions
- with male adaptor unions to adjustable male adaptor tee unions. This combination is simpler to produce, as screwing in and alignment are carried out separately.

d=Rohrussen-ø / mit Wandung 1 mm
 Ad=Aussen-ø der Andrehung
 e=kleinste Bohrung
 L=Mass in montiertem Zustand
 ▼=für Rohre mit Wandung 1,5 mm

d=ø extérieur du tube / avec paroi de 1 mm
 Ad=ø extérieur de la portée cylindrique
 e=ø-min. de passage
 L=après montage
 ▼=pour tubes avec paroi de 1,5 mm d'épaisseur

d=tube outside diameter / with wall thickness 1 mm
 Ad=outside diameter of cyl. stub
 e=minimum bore
 L=installed length
 ▼=for tubes with wall thickness of 1,5 mm

T-Einschraubverschraubung

Té mâle au centre

Male adaptor tee union

SO 33721

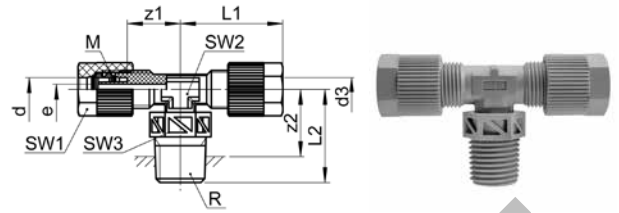

Type -d -R -d3	Mat.-Nr.	bar +	M	SW1	SW2	SW3	L1	L2	z1	z2	e	kg/100
R=Rohrgewinde (kegelig)				R=Filetage-gaz BSP (conique)			R=BSP thread (tapered)					
SO 33721-6-1/8-6	168.3701.100	10	10x1.0	12	8	10	25.0	19.0	14.0	14.0	2.8	0.645
SO 33721-6-1/4-6	168.3701.110	10	10x1.0	12	8	14	25.0	24.5	14.0	16.5	2.8	0.499
SO 33721-8-1/8-8	168.3701.160	10	12x1.0	14	10	10	27.5	20.0	14.5	15.0	4.8	0.814
SO 33721-8-1/4-8	168.3701.170	10	12x1.0	14	10	14	27.5	25.5	14.5	17.5	4.8	0.984
SO 33721-10-1/4-10	168.3701.270	10	14x1.0	17	12	14	30.0	26.5	16.0	18.5	6.6	1.420
SO 33721-10-3/8-10	168.3701.280	10	14x1.0	17	12	17	30.0	27.0	16.0	19.0	6.6	1.561
▼ SO 33721-107-1/4-107	168.3701.320	10	14x1.0	17	12	14	30.0	26.5	16.0	18.5	5.6	1.448
▼ SO 33721-107-3/8-107	168.3701.330	10	14x1.0	17	12	17	30.0	27.0	16.0	19.0	5.6	1.387

KONVARI

d=Rohrassen-ø / mit Wandung 1 mm
 e=kleinste Bohrung
 L=Mass in montiertem Zustand
 ▼=für Rohre mit Wandung 1,5 mm

d=ø extérieur du tube / avec paroi de 1 mm
 e=ø min. de passage
 L=après montage
 ▼=pour tubes avec paroi de 1,5 mm d'épaisseur

d=tube outside diameter / with wall thickness 1 mm
 e=minimum bore
 L=installed length
 ▼=for tubes with wall thickness of 1,5 mm

Ventile PA

Vannes PA

Valves PA

SO NV 32A21



Reguliertventil
Vanne de réglage
Regulating valve

569

SO NV 31A21E



Reguliert-Eckventil
Vanne-équerre de réglage
Elbow regulating valve

572

SO NV 31A21EB



Reguliert-Eckventil mit Einschraubgewinde
Vanne-équerre de réglage avec filetage
Elbow regulating valve with male adaptor thread

572

SO CV 33B21



Kegelrückschlagventil
Clapet anti-retour à siège conique
Taper seat non-return valve

575

SO BV 38A00



Absperrhahn mit Innengewinde
Vanne à boisseau avec taraudage
Stopcock with female thread

577

SO BV 38A21



Absperrhahn
Vanne à boisseau
Stopcock

577

SO 30511

Einschraubtülle R
Douille cannelée à visser R
Male adaptor hose nozzle R

705

KOLVANZ.CZ

Kunststoff Flip

Verschraubungen

Plastique Flip

























Raccords

Plastic Flip

Unions



KONVANTZ.COM

	Seite/Page/Page		Seite/Page/Page		Seite/Page/Page
Abschlusszapfen Bouchon d'arrêt Plug	458  FP 30002	Einschraubwinkel Coude mâle Male elbow connector	464  FP 32450	Y-Verbindung Y égal Y connector	469  FP 35050
Gerade Verbindung Union double Straight connector	459  FP 31050	Einschraubwinkel lang Coude mâle long Male elbow connector long	464  FP 32550	Y-Einschraubverbindung Y mâle Y connector male	470  FP 35150
Gerade Verbindung reduziert Union double réduite Straight connector reduced	459  FP 31050 RED	Einstellwinkel Coude enfichable Adjustable elbow	465  FP 32650	Einschraubwinkel 45° Coude mâle 45° Male elbow connector 45°	470  FP 35250
Einschraubverbindung Union mâle Male connector	460  FP 31150	Einstellwinkel reduziert Coude enfichable réduit Adjustable elbow reduced	465  FP 32650 RED	Y-Einsteckverbindung Y enfichable Y connector	471  FP 35650
Aufschraubverbindung kegelig Union femelle conique Female connector tapered	461  FP 31250	Schwenkverbindung Coude banjo Banjo connector	466  FP 32850	Einschraubverbindung drehbar Union mâle rotatif Male connector swivelling	472-473  FP 31950
Gerade Schottverbindung Union double traversée de cloison Panel mount connector	461  FP 31550	T-Verbindung Té égal Tee connector	467  FP 33050	Einschraubwinkel drehbar Coude mâle rotatif Male elbow connector swivelling	473  FP 32950
Gerade Einsteckreduzierung Réduction droite enfichable Reduction connector	462  FP 31850	T-Einschraubverbindung Té mâle Male tee connector	468  FP 33750	Einschraubverbindung mit Rückschlagventil Union mâle avec clapet anti-retour Straight connector with non-return valve	474  FP 37350
Winkelverbindung Coude égal Elbow connector	463  FP 32050	L-Einschraubverbindung Té mâle L Male L connector	468  FP 33850	Schwenkbares Drosselrückschlagventil Clapet anti-retour lim. de débit orientable Swivelling throttle non-return valve	475-476  FP 37750

Führung / Guide / Guide
Spannzange / Griffe / Chuck
 Verwendung von Nylon- und Polyurethanschläuchen
 Hohe Rückhaltekraft
 Utilisation de tubes nylon et polyuréthane
 Effort de maintien
 Accepts nylon, soft nylon and polyurethane tubes
 Has large retaining force

Druckring / Colletette de déblocage / Release button
 Leicht lösbar
 Der Druckring löst die Spannzange zum Abnehmen des Schlauchs und verhindert, dass die Spannzange zu tief in die Schlauchoberfläche eindringt.
 Faible force de dégagement
 La colletette de déblocage libère la griffe pour retirer le tuyau et empêche la griffe de pénétrer trop profondément dans la surface du tuyau.
 Low disconnection force
 The release button unblocks the chuck for removing the hose and prevents the chuck from penetrating too deeply into the hose surface.

Dichtung / Joint / Seal
 Für grossen Druckbereich von 1 bar bis 10 bar geeignet. Die Spezialdichtung gewährleistet gute Dichtigkeit, verbunden mit geringem Widerstand beim Einfügen des Schlauches.
 Approprié pour une large gamme de pression de 1 bar à 10 bar. L'utilisation d'un joint spécial assure l'étanchéité et réduit l'effort à l'insertion du tube.
 Can be used for a wide range of pressure 1 bar to 10 bar. The use of a special seal ensures positive sealing and reduced resistance when the tube is being inserted.

Kunststoffschlauch / Tube en plastique / Plastic tube
 (nur kalibrierte Schläuche verwenden)
 (n'utiliser que des tubes calibrés)
 (use only calibrated tubes)

Körper / Corps / Body
O-Ring / Joint torique / O-ring
Anschlussgewinde / Filetage de connexion / Connection thread

- Kleiner Einbauraum
- Schwenkbarer Körper
- Mit Dichtung (M5 zylindrisch) oder PTFE beschichtet (R 1/8 konisch)
- Raccordement dans les espaces réduits
- Corps orientable
- Avec joint (M5 cylindrique) ou filetage revêtu avec PTFE (R 1/8 conique)
- Effective when piping in a confined space
- Rotatable body
- With O-ring (M5 cylindrical) or PTFE coated (R 1/8 taper)

© by SERTO AG, Switzerland

Technische Daten / Données techniques / Technical data

Medium / Fluide / Operating media	Druckluft, Wasser ¹⁾ / Air comprimé, eau ¹⁾ / Compressed air, water ¹⁾
Betriebsdruckbereich / Plage de pression de fonctionnement / Operating pressure range	1 bar - 10 bar
Prüfdruck / Pression de test / Test pressure	30 bar
Umgebungs- und Medientemperatur / Température ambiante et du fluide / Ambient and media temperature	Druckluft / Air comprimé / Compressed air: -5°C - +60°C Wasser / Eau / Water: 0°C - +40°C
Anschlussmöglichkeiten / Options de connexion / Connections options	M5 1/8 - 1/2 konisch / conique / taper thread Kunststoffschlauch / Tube / Plastic tube
	mit Dichtung / avec joint / with O-ring PTFE beschichtet / revêtement PTFE / PTFE coated metrisch / métrique / metric

¹⁾ Kein Trinkwasser! Druckspitzen müssen kleiner als der max. zulässige Betriebsdruck sein.

¹⁾ Pas d'eau potable! Les pointes de pression doivent être inférieures à la pression de service maximale admissible.

¹⁾ No drinking water! Pressure peaks must be lower than the max. permissible operating pressure.

Werkstoff / Matériau / Material

Körper / Corps / Body	PBT
Anschlussgewinde / Filetage de connexion / Connection thread	Messing / Laiton / Brass
Spannzange / Griffe / Chuck	Edelstahl / Acier inoxydable / Stainless steel
Führung / Guide / Guide	Edelstahl / Acier inoxydable / Stainless steel Messing / laiton / brass
Druckring / Colletette de déblocage / Release button	POM
Dichtung, O-Ring / Joint, Joint torique / Seal, O-ring	NBR

Verwendbare Schläuche / Tubes utilisables / Applicable tubes

Material / Matériau / Material	Polyamid PA 11w/12w, Polyurethan Polyamide PA 11w/12w, Polyurethane Polyamide PA 11w/12w, Polyurethane
Aussendurchmesser / Diamètre ext. du tube / Tube outside diameter	4, 6, 8, 10, 12

- Schnelle Montage und Demontage
- Für grossen Druckbereich von 1 bar bis 10 bar geeignet
- Verwendung von Nylon- und Polyurethanschläuchen

- Montage et démontage économique
- Pour une large plage de pression 1 bar à 10 bar
- Utilisation de tubes nylon ou polyuréthane

- Quick assembling and disassembling
- Can be used for wide range of pressure 1 bar to 10 bar
- Accepts nylon and polyurethane tubes

Abschlusszapfen

Bouchon d'arrêt

Plug

FP 30002

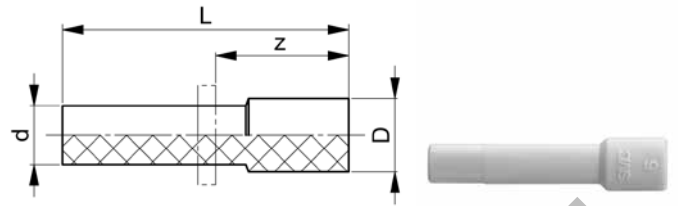

Type -d	Mat.-Nr.	L	D	z	g/Stk
FP 30002-4	TFP.300.0400	32.0	6.0	19.0	1
FP 30002-6	TFP.300.0600	35.0	8.0	22.0	1
FP 30002-8	TFP.300.0800	39.0	10.0	25.0	2
FP 30002-10	TFP.300.1000	43.0	12.0	27.5	4
FP 30002-12	TFP.300.1200	45.5	14.0	28.5	5

Den Abschlusszapfen FP 30002 bis zum Anschlag in den SERTO-Flip einführen. Zur Demontage Druckring leicht andrücken und Abschlusszapfen herausziehen.

Introduire le bouchon d'arrêt FP 30002 jusqu'au fond dans le SERTO-Flip. Pour démonter, presser légèrement le poussoir manuel et sortir le bouchon d'arrêt du SERTO-Flip.

Insert the plug FP 30002 and push it all the way into the SERTO-Flip fitting. To dismantle press the release button and withdraw the plug.

Gerade Verbindung
Union double
Straight connector

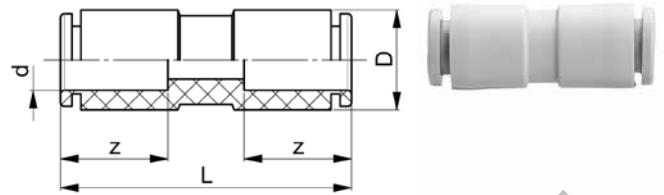

FP 31050

Type -d	Mat.-Nr.	L	D	z	g/Stk
FP 31050-4	TFP.310.0400	27.6	8.2	13.3	2
FP 31050-6	TFP.310.0600	27.6	10.4	13.3	2
FP 31050-8	TFP.310.0800	29.4	13.3	14.2	4
FP 31050-10	TFP.310.1000	32.2	15.9	15.6	6
FP 31050-12	TFP.310.1200	35.0	18.5	17.0	8

**Gerade Verbindung redu-
 ziert**
Union double réduite
Straight connector reduced

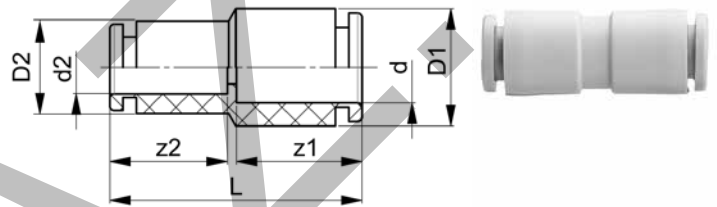

FP 31050 RED

Type -d -d2	Mat.-Nr.	L	D1	D2	z1	z2	g/Stk
FP 31050-6-4	TFP.310.0604	27.6	10.4	8.2	13.3	13.3	2
FP 31050-8-6	TFP.310.0806	28.5	13.3	10.4	14.2	13.3	3
FP 31050-10-8	TFP.310.1008	30.8	15.9	13.2	15.6	14.2	5
FP 31050-12-10	TFP.310.1210	33.6	18.5	15.9	17.0	15.6	7

Einschraubverbindung
Union mâle
Male connector

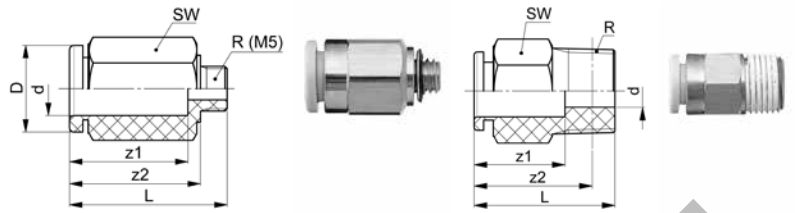

FP 31150

Type -d -R	Mat.-Nr.	SW	L	D	z1	z2	g/Stk
R=Rohrgewinde (kegelig)	R=Filetage-gaz BSP (conique)	R=BSP thread (tapered)					
FP 31150-4-M5	TFP.311.0441	8	17.7	8.0	13.3	14.7	3
FP 31150-6-M5	TFP.311.0641	10	17.7	10.0	13.3	14.7	4
FP 31150-4-1/8	TFP.311.0411	10	14.3	7.7	13.3	11.2	6
FP 31150-4-1/4	TFP.311.0412	14	16.7	7.7	13.3	12.0	15
FP 31150-6-1/8	TFP.311.0611	10	18.5	9.7	13.3	15.3	6
FP 31150-6-1/4	TFP.311.0612	14	16.7	9.7	13.3	12.0	13
FP 31150-6-3/8	TFP.311.0613	17	18.1	9.7	13.3	13.0	25
FP 31150-8-1/8	TFP.311.0811	14	22.5	13.0	14.2	19.4	12
FP 31150-8-1/4	TFP.311.0812	14	22.0	13.0	14.2	17.3	14
FP 31150-8-3/8	TFP.311.0813	17	18.1	13.0	14.2	13.0	21
FP 31150-10-1/8	TFP.311.1011	17	23.8	15.5	15.6	20.7	17
FP 31150-10-1/4	TFP.311.1012	17	27.3	15.5	15.6	22.6	22
FP 31150-10-3/8	TFP.311.1013	17	23.5	15.5	15.6	18.4	23
FP 31150-10-1/2	TFP.311.1014	22	22.3	15.5	15.6	15.9	45
FP 31150-12-1/4	TFP.311.1212	19	28.7	18.0	17.0	24.0	24
FP 31150-12-3/8	TFP.311.1213	19	26.0	18.0	17.0	20.7	25
FP 31150-12-1/2	TFP.311.1214	22	22.3	18.0	17.0	15.9	38

Aufschraubverbindung kegelig
Union femelle conique
Female connector tapered

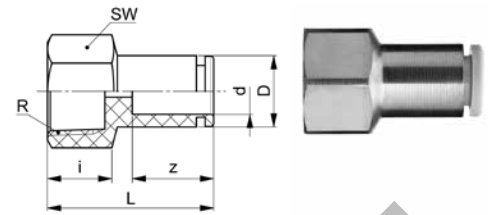
FP 31250

Type -d-R	Mat.-Nr.	SW	L	D	i	z	g/Stk
R=Rohrgewinde (kegelig)	R=Filetage-gaz BSP (conique)					R=BSP thread (tapered)	
FP 31250-4-1/8	TFP.312.0411	14	24.0	8.0	8.5	13.3	12
FP 31250-4-1/4	TFP.312.0412	17	29.0	8.0	13.0	13.3	22
FP 31250-6-1/8	TFP.312.0611	14	23.5	10.0	8.5	13.3	12
FP 31250-6-1/4	TFP.312.0612	17	28.5	10.0	13.0	13.3	22
FP 31250-6-3/8	TFP.312.0613	19	30.0	10.0	12.7	13.3	23
FP 31250-8-1/8	TFP.312.0811	14	24.0	13.0	8.5	14.2	13
FP 31250-8-1/4	TFP.312.0812	17	29.0	13.0	12.2	14.2	22
FP 31250-8-3/8	TFP.312.0813	19	30.5	13.0	13.5	14.2	31
FP 31250-10-1/4	TFP.312.1012	17	30.0	15.5	13.0	15.6	24
FP 31250-10-3/8	TFP.312.1013	19	31.3	15.5	13.3	15.6	26
FP 31250-12-1/4	TFP.312.1212	19	31.0	18.0	12.0	17.0	33
FP 31250-12-3/8	TFP.312.1213	19	32.3	18.0	13.3	17.0	28
FP 31250-12-1/2	TFP.312.1214	24	36.3	18.0	16.0	17.0	46

Gerade Schottverbindung
Union double traversée de cloison
Panel mount connector

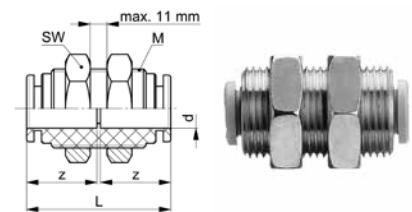
FP 31550

Type -d	Mat.-Nr.	M	SW	L	z	g/Stk
FP 31550-4	TFP.315.0400	12x1.0	14	27.5	13.3	23
FP 31550-6	TFP.315.0600	14x1.0	17	27.5	13.3	28
FP 31550-8	TFP.315.0800	16x1.0	19	29.0	14.2	34
FP 31550-10	TFP.315.1000	20x1.0	24	32.0	15.6	64
FP 31550-12	TFP.315.1200	22x1.0	27	34.5	17.0	64

Gerade Einsteckreduzierung
Réduction droite enfichable
Reduction connector

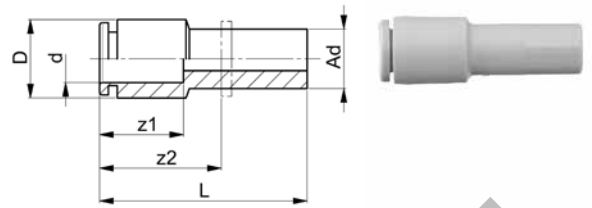

FP 31850

Type -d -Ad	Mat.-Nr.	L	D	z1	z2	g/Stk
FP 31850-4-A6	TFP.318.0406	28.7	8.2	13.3	15.3	2
FP 31850-6-A4	TFP.318.0604	33.6	10.4	13.3	20.3	2
FP 31850-6-A8	TFP.318.0608	31.5	10.4	13.3	17.5	2
FP 31850-6-A10	TFP.318.0610	34.0	10.4	13.3	18.4	2
FP 31850-6-A12	TFP.318.0612	35.6	12.0	13.3	18.7	3
FP 31850-8-A10	TFP.318.0810	35.2	13.3	14.2	19.5	3
FP 31850-8-A12	TFP.318.0812	36.5	13.3	14.2	19.5	3
FP 31850-10-A12	TFP.318.1012	39.2	15.9	15.6	22.1	5

Winkelverbindung
Coude égal
Elbow connector

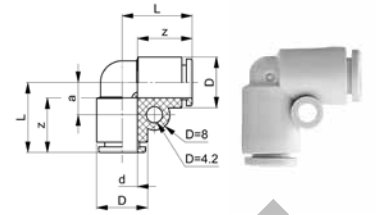

FP 32050

Type -d	Mat.-Nr.	L	D	a	z	g/Stk
FP 32050-4	TFP.320.0400	15.4	8.2	5.7	13.3	2
FP 32050-6	TFP.320.0600	16.2	10.4	6.8	13.3	3
FP 32050-8	TFP.320.0800	18.3	13.0	8.4	14.2	5
FP 32050-10	TFP.320.1000	20.5	15.9	9.7	15.6	7
FP 32050-12	TFP.320.1200	23.0	18.5	10.7	17.0	11

KONVANT

Einschraubwinkel

Coude mâle

Male elbow connector

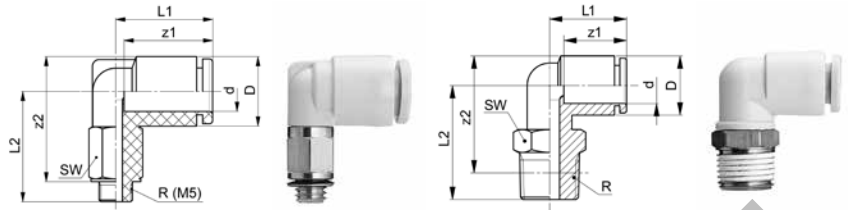

FP 32450

Type -d-R	Mat.-Nr.	SW	L1	L2	D	z1	z2	g/Stk
R=Rohrgewinde (kegelig)	R=Filetage-gaz BSP (conique)	R=BSP thread (tapered)						
FP 32450-4-M5	TFP.324.0441	7	15.4	14.7	8.2	13.3	15.9	3
FP 32450-6-M5	TFP.324.0641	7	14.5	16.5	10.4	13.3	18.7	3
FP 32450-4-1/8	TFP.324.0411	10	14.7	16.2	8.2	13.3	17.3	5
FP 32450-4-1/4	TFP.324.0412	14	14.7	21.7	8.2	13.3	21.0	14
FP 32450-6-1/8	TFP.324.0611	10	15.5	17.3	10.4	13.3	19.4	5
FP 32450-6-1/4	TFP.324.0612	14	15.5	22.8	10.4	13.3	23.3	15
FP 32450-6-3/8	TFP.324.0613	17	15.5	24.2	10.4	13.3	24.2	27
FP 32450-8-1/8	TFP.324.0811	10	16.5	18.7	13.3	14.2	22.1	6
FP 32450-8-1/4	TFP.324.0812	14	17.2	25.5	13.3	14.2	27.3	18
FP 32450-8-3/8	TFP.324.0813	17	17.2	25.5	13.3	14.2	27.0	25
FP 32450-10-1/4	TFP.324.1012	17	19.3	28.7	15.9	15.6	32.0	22
FP 32450-10-3/8	TFP.324.1013	17	19.3	29.6	15.9	15.6	32.5	22
FP 32450-12-1/4	TFP.324.1212	17	21.5	30.0	18.5	17.0	34.5	24
FP 32450-12-3/8	TFP.324.1213	17	21.5	30.8	18.5	17.0	35.0	24
FP 32450-12-1/2	TFP.324.1214	22	21.5	35.0	18.5	17.0	37.8	47

Einschraubwinkel lang

Coude mâle long

Male elbow connector long

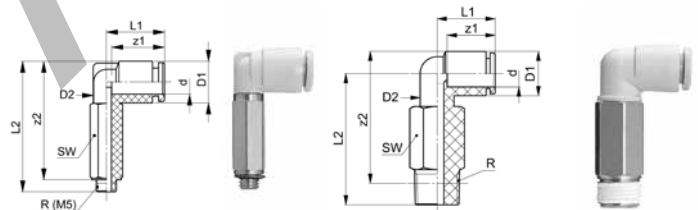

FP 32550

Type -d-R	Mat.-Nr.	SW	L1	L2	D1	D2	z1	z2	g/Stk
R=Rohrgewinde (kegelig)	R=Filetage-gaz BSP (conique)	R=BSP thread (tapered)							
FP 32550-4-M5	TFP.325.0441	7	15.4	25.7	8.2	7.0	13.3	26.8	6
FP 32550-6-M5	TFP.325.0641	7	14.5	27.5	10.4	7.0	13.3	29.5	6
FP 32550-4-1/8	TFP.325.0411	10	14.7	30.0	8.2	10.0	13.3	31.0	11
FP 32550-6-1/8	TFP.325.0611	10	15.5	31.0	10.4	10.0	13.3	33.0	12
FP 32550-6-1/4	TFP.325.0612	14	15.5	34.4	10.4	10.0	13.3	35.0	28
FP 32550-8-1/8	TFP.325.0811	10	16.5	32.4	13.3	10.0	14.2	36.0	12
FP 32550-8-1/4	TFP.325.0812	14	17.2	39.0	13.3	12.0	14.2	41.0	40
FP 32550-10-1/4	TFP.325.1012	17	19.3	53.0	15.9	17.0	15.6	56.2	59
FP 32550-10-3/8	TFP.325.1013	17	19.3	48.5	15.9	17.0	15.6	51.5	51
FP 32550-12-1/4	TFP.325.1212	17	21.5	54.2	18.5	17.0	17.0	58.8	61
FP 32550-12-3/8	TFP.325.1213	17	21.5	49.8	18.5	17.0	17.0	54.0	53

Einstellwinkel
Coude enfichable
Adjustable elbow

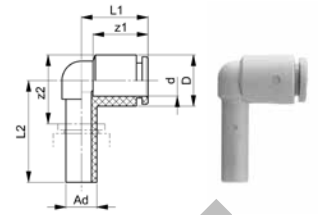
FP 32650

Type -d -Ad	Mat.-Nr.	L1	L2	D	z1	z2	g/Stk
FP 32650-4-A4	TFP.326.0400	14.5	21.0	8.2	13.3	12.0	2
FP 32650-6-A6	TFP.326.0600	15.4	22.4	10.4	13.3	14.2	2
FP 32650-8-A8	TFP.326.0800	17.2	26.2	13.3	14.2	18.7	3
FP 32650-10-A10	TFP.326.1000	19.3	28.2	15.9	15.6	20.5	5
FP 32650-12-A12	TFP.326.1200	21.5	31.0	18.5	17.0	23.3	7

Einstellwinkel reduziert
Coude enfichable réduit
Adjustable elbow reduced

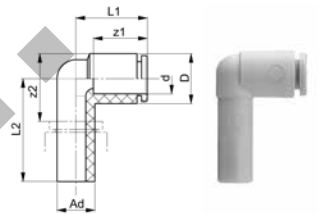
FP 32650 RED

Type -d -Ad	Mat.-Nr.	L1	L2	D	z1	z2	g/Stk
FP 32650-4-A6	TFP.326.0406	14.7	24.5	8.2	13.3	15.5	2
FP 32650-4-A8	TFP.326.0408	14.7	29.5	8.2	13.3	19.4	2
FP 32650-6-A8	TFP.326.0608	15.5	24.2	10.4	13.3	15.3	2
FP 32650-6-A10	TFP.326.0610	15.5	31.5	10.4	13.3	21.3	3
FP 32650-8-A10	TFP.326.0810	18.8	27.0	13.3	14.2	18.0	4
FP 32650-8-A12	TFP.326.0812	18.8	34.0	13.3	14.2	23.5	5

Schwenkverbindung
Coude banjo
Banjo connector

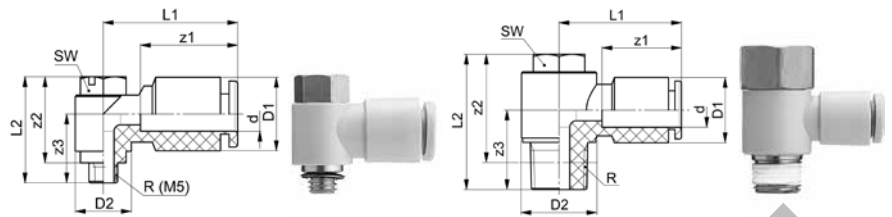

FP 32850

Type -d-R	Mat.-Nr.	SW	L1	L2	D1	D2	z1	z2	z3	g/Stk
R=Rohrgewinde (kegelig)	R=Filetage-gaz BSP (conique)	R=BSP thread (tapered)								
FP 32850-4 M5	TFP.328.0441	8	17.5	18.5	8.2	9.8	13.3	15.0	11.0	6
FP 32850-6 M5	TFP.328.0641	8	18.3	18.5	10.4	9.8	13.3	15.0	11.0	6
FP 32850-4-1/8	TFP.328.0411	8	19.3	25.5	8.2	13.5	13.3	22.5	13.7	13
FP 32850-6-1/8	TFP.328.0611	8	20.5	25.5	10.4	13.5	13.3	22.5	13.7	14
FP 32850-6-1/4	TFP.328.0612	10	20.0	30.5	10.4	15.4	13.3	26.0	18.0	25
FP 32850-8-1/8	TFP.328.0811	12	23.5	27.5	13.3	17.6	14.2	24.5	15.0	23
FP 32850-8-1/4	TFP.328.0812	12	23.5	31.0	13.3	17.6	14.2	26.5	18.5	29
FP 32850-8-3/8	TFP.328.0813	14	23.0	35.5	13.3	20.6	14.2	30.0	19.5	44
FP 32850-10-1/4	TFP.328.1012	14	26.0	35.0	15.9	20.6	15.6	30.0	20.0	38
FP 32850-10-3/8	TFP.328.1013	14	26.0	35.3	15.9	20.6	15.6	30.0	20.3	46
FP 32850-12-3/8	TFP.328.1213	17	28.5	37.5	18.5	25.2	17.0	32.5	21.5	60
FP 32850-12-1/2	TFP.328.1214	17	28.5	41.0	18.5	25.2	17.0	34.4	24.5	78

KONVIA

T-Verbindung
Té égal
Tee connector

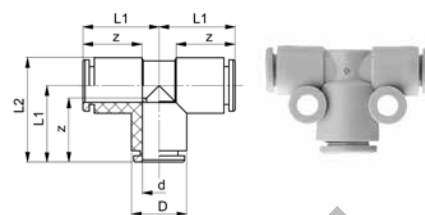

FP 33050

Type -d	Mat.-Nr.	L1	L2	D	z	g/Stk
FP 33050-4	TFP.330.0400	15.4	19.5	8.2	13.3	6
FP 33050-6	TFP.330.0600	16.2	21.5	10.4	13.3	8
FP 33050-8	TFP.330.0800	18.5	25.2	13.3	14.2	7
FP 33050-10	TFP.330.1000	22.5	30.5	15.9	15.6	11
FP 33050-12	TFP.330.1200	24.5	33.7	18.5	17.0	16

T-Einschraubverbindung

Té mâle

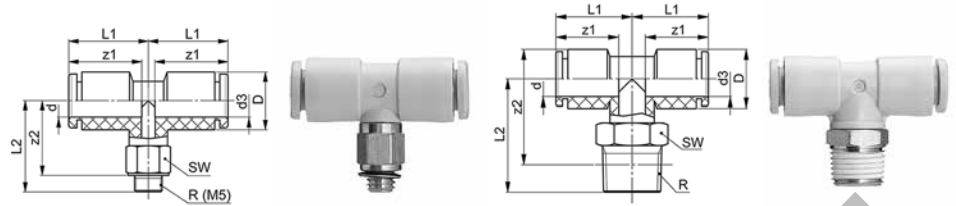
Male tee connector



FP 33750

Type -d-R-d3	Mat.-Nr.	SW	L1	L2	D	z1	z2	g/Stk
R=Rohrgewinde (kegelig)	R=Filetage-gaz BSP (conique)	R=BSP thread (tapered)						
FP 33750-4-M5-4	TFP.337.0441	7	15.4	14.7	8.2	13.3	15.9	4
FP 33750-6-M5-6	TFP.337.0641	7	14.5	16.5	10.4	13.3	18.7	4
FP 33750-4-1/8-4	TFP.337.0411	10	14.7	16.2	8.2	13.3	17.3	6
FP 33750-6-1/8-6	TFP.337.0611	10	15.5	17.3	10.4	13.3	19.4	6
FP 33750-6-1/4-6	TFP.337.0612	14	15.5	22.8	10.4	13.3	23.3	16
FP 33750-6-3/8-6	TFP.337.0613	17	15.5	24.2	10.4	13.3	24.2	27
FP 33750-8-1/8-8	TFP.337.0811	10	16.5	18.7	13.3	14.2	22.1	8
FP 33750-8-1/4-8	TFP.337.0812	14	17.2	25.5	13.3	14.2	27.3	19
FP 33750-8-3/8-8	TFP.337.0813	17	17.2	25.5	13.3	14.2	27.0	27
FP 33750-10-1/4-10	TFP.337.1012	17	19.3	28.7	15.9	15.6	32.0	24
FP 33750-10-3/8-10	TFP.337.1013	17	19.3	29.5	15.9	15.6	32.5	25
FP 33750-12-1/4-12	TFP.337.1212	17	21.5	30.0	18.5	17.0	34.5	27
FP 33750-12-3/8-12	TFP.337.1213	17	21.5	30.8	18.5	17.0	35.0	28
FP 33750-12-1/2-12	TFP.337.1214	22	21.5	35.0	18.5	17.0	37.8	50

L-Einschraubverbindung

Té mâle L

Male L connector

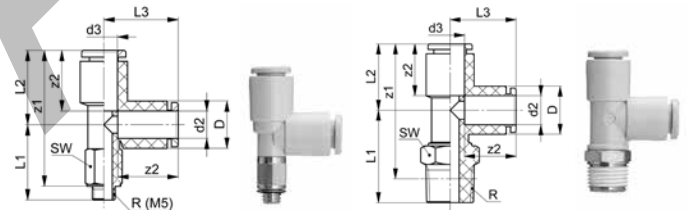

FP 33850

Type -R-d2-d3	Mat.-Nr.	SW	L1	L2	L3	D	z1	z2	g/Stk
R=Rohrgewinde (kegelig)	R=Filetage-gaz BSP (conique)	R=BSP thread (tapered)							
FP 33850-M5-4-4	TFP.338.0441	7	14.7	15.5	15.4	8.2	27.3	13.3	4
FP 33850-M5-6-6	TFP.338.0641	7	16.5	16.3	16.5	10.4	29.8	13.3	6
FP 33850-1/8-4-4	TFP.338.0411	10	16.2	15.3	15.4	8.2	28.5	13.3	6
FP 33850-1/8-6-6	TFP.338.0611	10	17.3	16.3	16.2	10.4	30.5	13.3	6
FP 33850-1/4-6-6	TFP.338.0612	14	22.8	16.3	16.2	10.4	34.4	13.3	16
FP 33850-3/8-6-6	TFP.338.0613	17	24.2	16.3	16.2	10.4	35.3	13.3	28
FP 33850-1/8-8-8	TFP.338.0811	10	18.7	18.2	18.3	13.3	33.8	14.2	8
FP 33850-1/4-8-8	TFP.338.0812	14	25.5	18.2	18.3	13.3	39.0	14.2	20
FP 33850-3/8-8-8	TFP.338.0813	17	25.5	18.2	18.3	13.3	38.5	14.2	27
FP 33850-1/4-10-10	TFP.338.1012	17	28.7	20.5	20.5	15.9	44.5	15.6	25
FP 33850-3/8-10-10	TFP.338.1013	17	29.5	20.5	20.5	15.9	45.0	15.6	25
FP 33850-1/4-12-12	TFP.338.1212	17	30.0	23.0	23.0	18.5	48.3	17.0	28
FP 33850-3/8-12-12	TFP.338.1213	17	30.8	23.0	23.0	18.5	48.8	17.0	28
FP 33850-1/2-12-12	TFP.338.1214	22	34.8	23.0	23.0	18.5	51.5	17.0	51

Y-Verbindung
Y égal
Y connector

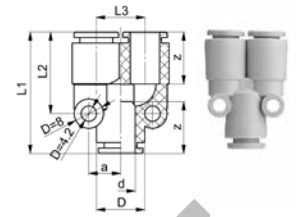

FP 35050

Type -d	Mat.-Nr.	L1	L2	L3	D	a	z	g/Stk
FP 35050-4	TFP.350.0400	29.0	18.2	8.2	8.2	5.7	13.3	3
FP 35050-6	TFP.350.0600	30.2	19.5	10.4	10.4	6.8	13.3	4
FP 35050-8	TFP.350.0800	33.2	22.4	13.3	13.3	8.7	14.2	7
FP 35050-10	TFP.350.1000	37.0	25.0	15.9	15.9	10.2	15.6	11
FP 35050-12	TFP.350.1200	41.2	27.8	18.5	18.5	11.5	17.0	16

Y-Verbindung reduziert
Y réduit
Y connector reduced

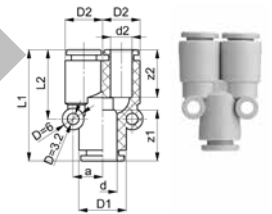

FP 35050 RED

Type -d -d2	Mat.-Nr.	L1	L2	D1	D2	a	z1	z2	g/Stk
FP 35050-6-4	TFP.350.0604	29.0	18.0	10.4	8.2	6.8	13.3	13.3	3
FP 35050-8-6	TFP.350.0806	31.0	19.5	13.0	10.4	8.2	14.2	13.3	5
FP 35050-10-8	TFP.350.1008	34.7	22.4	15.9	13.5	10.2	15.6	14.2	9
FP 35050-12-10	TFP.350.1210	38.5	25.0	18.5	15.9	11.5	17.0	15.6	13

Y-Einschraubverbindung

Y mâle

Y connector male

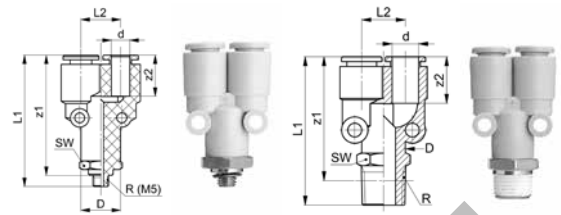

FP 35150

Type -d -R	Mat.-Nr.	SW	L1	L2	D	z1	z2	g/Stk
R=Rohrgewinde (kegelig)	R=Filetage-gaz BSP (conique)	R=BSP thread (tapered)						
FP 35150-4 M5	TFP.351.0441	10	34.0	8.2	8.2	31.0	13.3	7
FP 35150-6 M5	TFP.351.0641	12	35.0	10.4	10.4	32.0	13.3	10
FP 35150-4-1/8	TFP.351.0411	10	36.5	8.2	8.2	33.4	13.3	9
FP 35150-4-1/4	TFP.351.0412	14	41.0	8.2	8.2	36.2	13.3	19
FP 35150-6-1/8	TFP.351.0611	12	37.5	10.4	10.4	34.5	13.3	10
FP 35150-6-1/4	TFP.351.0612	14	42.0	10.4	10.4	37.3	13.3	19
FP 35150-6-3/8	TFP.351.0613	17	43.4	10.4	10.4	38.3	13.3	31
FP 35150-8-1/8	TFP.351.0811	14	40.7	13.3	13.3	37.5	14.2	16
FP 35150-8-1/4	TFP.351.0812	14	45.2	13.3	13.3	40.5	14.2	21
FP 35150-8-3/8	TFP.351.0813	17	46.5	13.3	13.3	41.5	14.2	33
FP 35150-10-1/4	TFP.351.1012	17	49.0	15.9	15.9	44.3	15.6	26
FP 35150-10-3/8	TFP.351.1013	17	50.5	15.9	15.9	45.3	15.6	33
FP 35150-12-3/8	TFP.351.1213	19	54.4	18.5	18.5	49.3	17.0	39

Einschraubwinkel 45°

Coude mâle 45°

Male elbow connector 45°

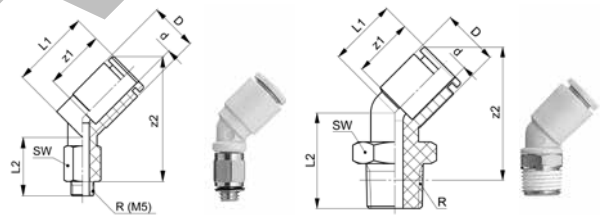

FP 35250

Type -d -R	Mat.-Nr.	SW	L1	L2	D	z1	z2	g/Stk
R=Rohrgewinde (kegelig)	R=Filetage-gaz BSP (conique)	R=BSP thread (tapered)						
FP 35250-4 M5	TFP.352.0441	7	14.5	13.0	8.2	13.3	22.9	3
FP 35250-6 M5	TFP.352.0641	7	14.5	17.0	10.4	13.3	27.5	4
FP 35250-4-1/8	TFP.352.0411	10	14.5	12.6	8.2	13.3	22.3	5
FP 35250-4-1/4	TFP.352.0412	14	14.5	17.3	8.2	13.3	25.3	14
FP 35250-6-1/8	TFP.352.0611	10	14.7	14.7	10.4	13.3	25.3	5
FP 35250-6-1/4	TFP.352.0612	14	14.7	19.3	10.4	13.3	28.3	15
FP 35250-8-1/8	TFP.352.0811	10	16.0	15.7	13.3	14.2	28.0	6
FP 35250-8-1/4	TFP.352.0812	17	16.0	22.4	13.3	14.2	33.0	18
FP 35250-8-3/8	TFP.352.0813	17	16.0	22.5	13.3	14.2	32.7	25
FP 35250-10-1/4	TFP.352.1012	17	17.6	29.0	15.9	15.6	41.8	22
FP 35250-10-3/8	TFP.352.1013	17	17.6	24.2	15.9	15.6	36.7	22
FP 35250-12-3/8	TFP.352.1213	17	19.5	24.2	18.5	17.0	38.5	23
FP 35250-12-1/2	TFP.352.1214	22	19.5	28.2	18.5	17.0	41.3	46

Y-Einsteckverbindung
Y enfichable
Y connector

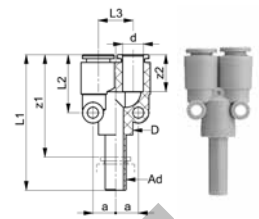

FP 35650

Type -d -Ad	Mat.-Nr.	L1	L2	L3	D	a	z1	z2	g/Stk
FP 35650-4-A4	TFP.356.0404	45.0	18.2	8.2	8.2	5.7	31.5	13.3	3
FP 35650-6-A6	TFP.356.0606	46.5	19.5	10.4	10.4	6.8	33.0	13.3	5
FP 35650-8-A8	TFP.356.0808	52.0	22.4	13.3	13.3	8.7	38.0	14.2	8
FP 35650-10-A10	TFP.356.1010	57.5	25.0	15.9	15.9	10.2	41.8	15.6	12
FP 35650-12-A12	TFP.356.1212	63.0	27.8	18.5	18.5	11.5	46.0	17.0	18

KONVANT

d=Rohraussen-ø
 Ad=Aussen-ø der Andrehung

d=ø extérieur du tube
 Ad=ø extérieur de la portée cylindrique

d=tube outside diameter
 Ad=outside diameter of cyl. stub

Einschraubverbindung drehbar

Gerade oder Winkel

Union mâle rotatif

Droit ou coudé

Male connector rotary

Straight or elbow

FP 31950
FP 32950

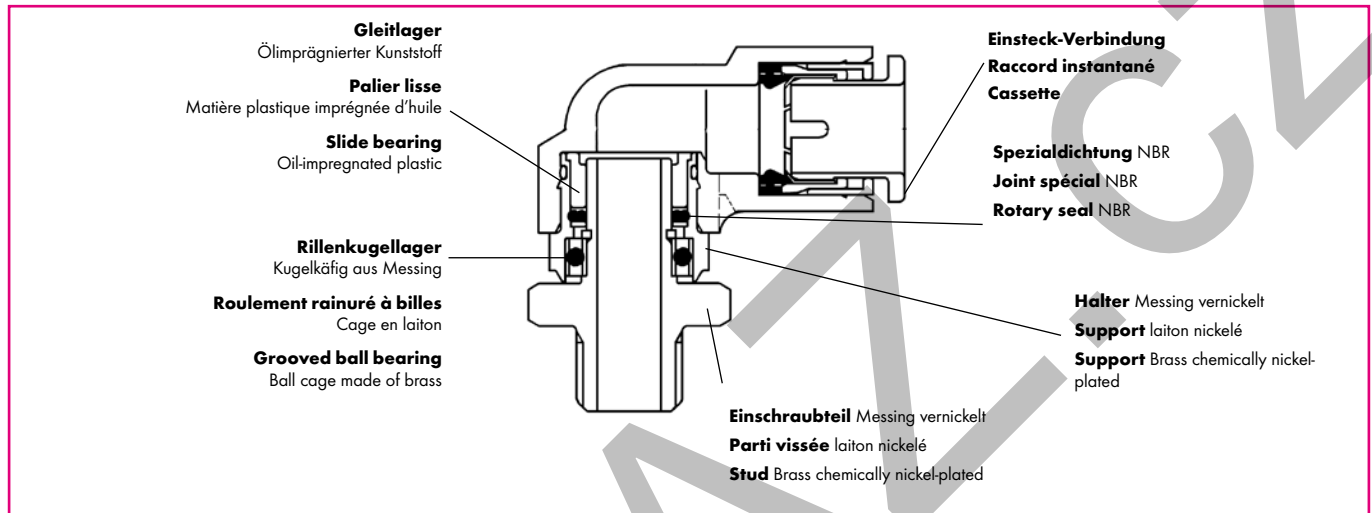

Technische Daten / Données techniques / Technical notes

Medium / Fluide / Fluid	Druckluft / Air comprimé / Compressed air				
Arbeitsdruck / Pression de travaille / Operating pressure max.	10 bar				
Arbeitsdruck / Pression de travaille / Operating pressure min.	1 bar				
Prüfdruck / Pression d'épreuve / Proof pressure	30 bar				
Umgebungstemperatur / Température ambiante / Ambient and fluid temperature	0°C - +60°C				
Drehzahl / Vitesse / Permissible number of rotation [1/min]	Ø 4	Ø 6	Ø 8	Ø 10	Ø 12
	500	500	400	300	250
Gewinde / Filetage / Thread	M5 metrisch/métrique/metric; 1/8 - 1/2 konisch/conique/taper				

Hinweise

Da Miniaturkugellager verwendet werden, müssen die Querkräfte möglichst klein gehalten werden. In diesen Fällen wird empfohlen, Polyurethanschläuche einzusetzen.

Remarque

Etant donné que des roulements à billes miniatures sont utilisés, les forces transversales doivent être maintenues aussi faibles que possible. Dans ces cas, il est recommandé d'utiliser des tuyaux en polyuréthane.

Caution

Minimise the load shown below to protect the ball bearing. A flexible polyurethane tube is recommended.

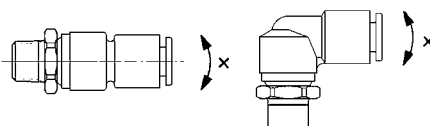

Einschraubverbindung drehbar

Union mâle rotatif

Male connector swivelling

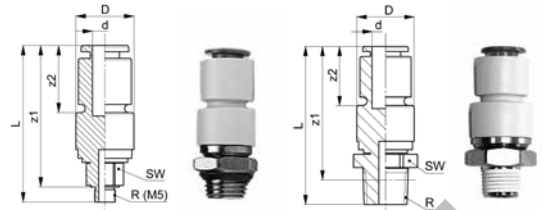

FP 31950

Type -d-R	Mat.-Nr.	SW	L	D	z1	z2	g/Stk
R=Rohrgewinde (kegelig)	R=Filetage-gaz BSP (conique)				R=BSP thread (tapered)		
FP 31950-4 M5	TFP.319.0441	8	36.5	12.0	33.0	16.0	9
FP 31950-6 M5	TFP.319.0641	8	37.5	14.0	33.5	17.0	12
FP 31950-4-1/8	TFP.319.0411	12	37.0	12.0	34.0	16.0	14
FP 31950-6-1/8	TFP.319.0611	14	38.5	14.0	35.5	17.0	17
FP 31950-6-1/4	TFP.319.0612	14	42.0	14.0	36.5	17.0	23
FP 31950-8-1/8	TFP.319.0811	17	43.0	17.0	40.0	18.5	23
FP 31950-8-1/4	TFP.319.0812	17	46.5	17.0	41.0	18.5	29
FP 31950-8-3/8	TFP.319.0813	17	47.0	17.0	41.5	18.5	37
FP 31950-10-1/4	TFP.319.1012	22	53.5	22.0	48.0	21.0	55
FP 31950-10-3/8	TFP.319.1013	22	54.0	22.0	48.5	21.0	63
FP 31950-10-1/2	TFP.319.1014	22	56.5	22.0	49.5	21.0	81
FP 31950-12-3/8	TFP.319.1213	24	56.0	24.0	50.5	22.0	75
FP 31950-12-1/2	TFP.319.1214	24	60.0	24.0	52.0	22.0	92

Einschraubwinkel drehbar

Coude mâle rotatif

Male elbow connector swivelling

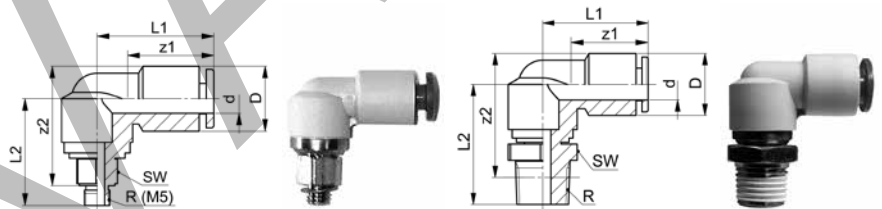

FP 32950

Type -d-R	Mat.-Nr.	SW	L1	L2	D	z1	z2	g/Stk
R=Rohrgewinde (kegelig)	R=Filetage-gaz BSP (conique)					R=BSP thread (tapered)		
FP 32950-4 M5	TFP.329.0441	8	21.0	20.5	10.4	16.0	22.0	9
FP 32950-6 M5	TFP.329.0641	8	23.0	21.0	12.8	17.0	23.5	12
FP 32950-4-1/8	TFP.329.0411	12	21.0	21.0	10.4	16.0	23.5	14
FP 32950-6-1/8	TFP.329.0611	14	23.0	22.0	12.8	17.0	25.5	17
FP 32950-6-1/4	TFP.329.0612	14	23.0	25.5	12.8	17.0	26.5	23
FP 32950-8-1/8	TFP.329.0811	17	26.0	25.5	15.2	18.5	30.0	23
FP 32950-8-1/4	TFP.329.0812	17	26.0	29.0	15.2	18.5	31.0	29
FP 32950-8-3/8	TFP.329.0813	17	26.0	30.0	15.2	18.5	32.0	38
FP 32950-10-1/4	TFP.329.1012	22	31.5	33.5	18.5	21.0	37.5	56
FP 32950-10-3/8	TFP.329.1013	22	31.5	34.0	18.5	21.0	38.0	64
FP 32950-12-3/8	TFP.329.1213	24	34.0	37.0	21.0	22.0	40.5	76
FP 32950-12-1/2	TFP.329.1214	24	34.0	38.5	21.0	22.0	42.0	93

Einschraubverbindung mit Rückschlagventil
Union mâle avec clapet anti-retour
Straight connector with non-return valve

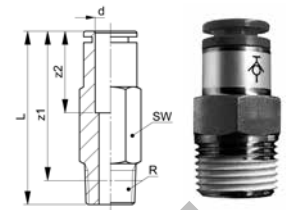

FP 37350

Type -d-R	Mat.-Nr.	SW	L	z1	z2	g/Stk
R=Rohrgewinde (kegelig)	R=Filetage-gaz BSP (conique)			R=BSP thread (tapered)		
FP 37350-4-1/8	TFP.373.0411	10	25.2	22.1	18.0	8
FP 37350-6-1/8	TFP.373.0611	12	36.5	33.4	19.0	16
FP 37350-6-1/4	TFP.373.0612	14	28.5	22.9	19.0	14
FP 37350-8-1/4	TFP.373.0812	14	45.0	39.7	21.5	27
FP 37350-10-1/4	TFP.373.1012	17	50.0	44.5	24.0	34

KROVAVAZ

Schwenkbares Drosselrückschlagventil Clapet anti-retour limiteur de débit orientable Swivelling throttle non-return valve

FP 37650
FP 37750

Technische Daten / Données techniques / Technical notes

Medium / Fluide / Fluid	Druckluft gefiltert 10 µm, geölt oder ungeölt Air comprimé filtre à 10 microns avec ou sans huile Compressed air filtered 10 µm oiled or not
Anschluss / Raccordement / Stud	PTFE beschichtet / revêtement PTFE / PTFE coated
Aussengewinde / Filetage / Thread	1/8, 1/4, 3/8, 1/2 konisch / conique / taper
Einstellbereich / Plage de réglage / Number of needle rotation	10 Umdrehungen / tours / turns
Prüfdruck / Pression d'épreuve / Proof pressure	1.5 MPa (~ 15-bar)
Betriebsdruckbereich / Pression de service / Working pressure	0.1 - 1.0 MPa (~ 1 - 10-bar)
Betriebstemperaturbereich / Température / Ambient and fluid temperature	+5°C - +60°C
Einbaulage / Position de montage / Built-in position	beliebig / quelconque / any

- Kostengünstige Montage
- Hoher Durchfluss
- Präzise Regulierbarkeit auch bei kleinem Durchfluss
- 360° schwenkbar
- Für Nylon- und Polyurethanschläuche geeignet

- Montage et démontage économique
- Débit optimal
- Grand précision de réglage même pour les petits débits
- Orientable sur 360°
- Utilisation pour tubes en nylon et polyuréthane

- Minimises installation time
- Constant speed easily set
- Speed may be accurately controlled even at low speed
- Body swivels 360°
- Accepts nylon and polyurethane tubing

FP 37650



FP 37750

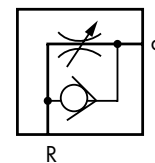

Durchfluss

Eingangsdruck 5 bar

Caractéristique de débit

Pression d'alimentation 5 bar

Air flow

Supply pressure 5 bar

Grösse/Taille/Size
4-1/8, 6-1/8, 8-1/8

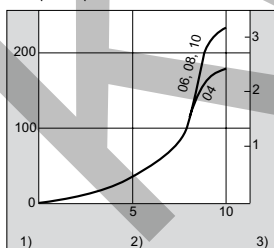

1) Volumenstrom / Débit / Air flow [l/min]

Grösse/Taille/Size
6-1/4, 8-1/4, 10-1/4

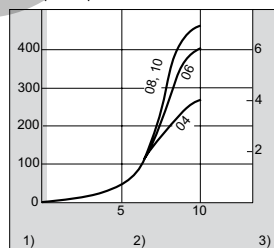

2) Anzahl Nadelumdrehungen / Nombre de tour de vis / Number of needle rotation

Grösse/Taille/Size
6-3/8, 8-3/8, 10-3/8, 12-3/8

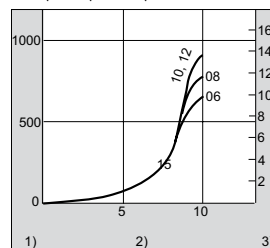

3) Aequ. Querschnitt / Section équivalente / Effective orifice [mm²]

Grösse/Taille/Size
12-1/2

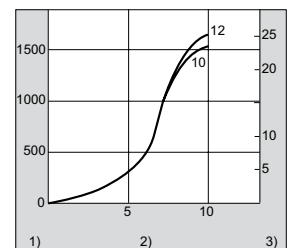

Schwenkbares Drosselrückschlagventil
Clapet anti-retour limiteur de débit orientable
Throttle non-return valve swivelling

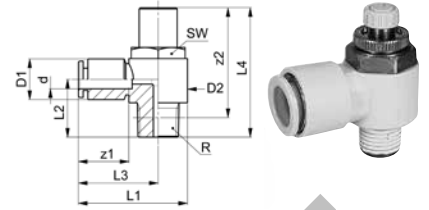

FP 37650

Type -d -R	Mat.-Nr.	SW	L1	L2	L3	L4	D1	D2	z1	z2	g/Stk
R=Rohrgewinde (kegelig)		R=Filetage-gaz BSP (conique)				R=BSP thread (tapered)					
FP 37650-4-1/8	TFP.376.0411	12	27.5	13.5	20.5	35.0	9.5	14.0	12.5	32.0	17
FP 37650-6-1/8	TFP.376.0611	12	27.5	13.5	20.5	35.0	11.5	14.0	13.5	32.0	17
FP 37650-6-1/4	TFP.376.0612	17	34.5	18.0	25.0	40.0	13.0	18.5	17.0	34.5	32
FP 37650-6-3/8	TFP.376.0613	19	39.5	20.0	28.0	45.5	13.0	23.0	17.0	40.0	55
FP 37650-8-1/8	TFP.376.0811	12	32.5	13.5	25.5	35.0	15.0	14.0	18.5	32.0	19
FP 37650-8-1/4	TFP.376.0812	17	36.5	18.0	27.0	40.0	15.0	18.5	18.5	34.5	34
FP 37650-8-3/8	TFP.376.0813	19	41.0	20.0	29.5	45.5	15.0	23.0	18.5	40.0	57
FP 37650-10-1/4	TFP.376.1012	17	43.0	18.5	32.0	40.0	18.5	18.5	21.0	34.5	36
FP 37650-10-3/8	TFP.376.1013	19	43.5	20.0	32.0	45.5	18.5	23.0	21.0	40.0	59
FP 37650-12-3/8	TFP.376.1213	19	44.5	20.0	33.0	45.5	21.0	23.0	22.0	40.0	61
FP 37650-12-1/2	TFP.376.1214	24	49.0	24.5	35.0	56.5	21.0	28.5	22.0	49.5	101

360° schwenkbares Drosselrückschlagventil
Clapet anti-retour limiteur de débit orientable 360°
Throttle non-return valve swivelling 360°

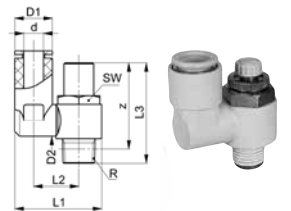

FP 37750

Type -d -R	Mat.-Nr.	SW	L1	L2	L3	D1	D2	z	g/Stk
R=Rohrgewinde (kegelig)		R=Filetage-gaz BSP (conique)				R=BSP thread (tapered)			
FP 37750-4-1/8	TFP.377.0411	12	25.0	13.0	35.0	9.5	9.5	32.0	18
FP 37750-6-1/8	TFP.377.0611	12	27.0	14.0	35.0	11.5	11.0	32.0	18
FP 37750-6-1/4	TFP.377.0612	17	34.0	18.5	40.0	13.0	13.0	34.5	33
FP 37750-6-3/8	TFP.377.0613	19	38.5	21.0	45.5	13.0	13.0	40.0	56
FP 37750-8-1/8	TFP.377.0811	12	31.0	16.0	35.0	15.0	13.0	32.0	21
FP 37750-8-1/4	TFP.377.0812	17	35.0	18.5	40.0	15.0	13.0	34.5	36
FP 37750-8-3/8	TFP.377.0813	19	39.5	20.5	45.5	15.0	13.0	40.0	59
FP 37750-10-1/4	TFP.377.1012	19	43.5	23.0	48.5	18.5	16.0	43.0	67
FP 37750-10-3/8	TFP.377.1013	19	43.5	23.0	45.5	18.5	16.0	40.0	63
FP 37750-12-3/8	TFP.377.1213	19	45.0	23.0	45.5	21.0	16.0	40.0	65
FP 37750-12-1/2	TFP.377.1214	24	52.0	27.0	57.0	21.5	19.5	50.5	106

Ventile Metall

Messing, Edelstahl, Stahl

Vannes en métal

Laiton, acier inoxydable,
acier

Valves in metal

Brass, stainless steel, steel



Seite/Page/Page

Seite/Page/Page

Seite/Page/Page

Ventile Messing M
Vannes laiton M
Valves brass M

Ventile Messing G
Vannes laiton G
Valves brass G

Durchgangshahn
Vanne simple à passage direct
Total-flow cock

518



SO PV 08E01

Ventile Edelstahl
Vannes acier inoxydable
Valves stainless steel

Regulierventil
Vanne de réglage
Regulating valve

481-485



SO NV 41A21

Regulierventil
Vanne de réglage
Regulating valve

505-507



SO NV 01A21

Feinregulierventil
Vanne de réglage fin
Fine regulating valve

486



SO NV 41C21

Feinregulierventil
Vanne de réglage fin
Fine regulating valve

508



SO NV 01C21

Regulierventil
Vanne de réglage
Regulating valve

519-524



SO NV 51A00

Regulier-Eckventil
Vanne-équerre de réglage
Elbow regulating valve

487-491



SO NV 41A21E

Regulier-Eckventil
Vanne-équerre de réglage
Elbow regulating valve

509-512



SO NV 01A21E

Feinregulierventil
Vanne de réglage fin
Fine regulating valve

525



SO NV 51C00

Feinregulier-Eckventil
Vanne-équerre de réglage fin
Elbow fine regulating valve

492-494



SO NV 41C21E

Feinregulier-Eckventil
Vanne-équerre de réglage fin
Elbow fine regulating valve

513



SO NV 01C21E

Dosierventil
Vanne de réglage de précision
Metering valve

526



SO NV 51D21

Kegelrückschlagventil
Clapet anti-retour à siège conique
Taper seat non-return valve

495-499



SO CV 43A21

Dosier-Eckventil
Vanne-équerre de réglage de précision
Metering elbow valve

513



SO NV 01D21E

Regulier-Eckventil
Vanne-équerre de réglage
Elbow regulating valve

527-530



SO NV 51A21E

Schwenkverschraubung
Coude banjo
Single banjo

500-501



SO 47724

Kegelrückschlagventil
Clapet anti-retour à siège conique
Taper seat non-return valve

514



SO CV 03A21

Feinregulier-Eckventil
Vanne-équerre de réglage fin
Elbow fine regulating valve

531-532



SO NV 51C21E

Mini-Kugelhahn
Mini vanne à bille
Mini-ball valve

502-504



SO BV 48A00

Kugelhahn voller Durchgang
Vanne à bille avec passage total
Ball valve with full flow

517



SO BV 08C00

Kegelrückschlagventil
Clapet anti-retour à siège conique
Taper seat non-return valve

533-537



SO CV 53B21

Seite/Page/Page

Seite/Page/Page

Kugelhahn
Vanne à bille
Ball valve

538-542



Ventile Zubehör
Vannes accessories
Valves accessories

SO BV 58A00

Nadelventil
Vanne à pointeau
Needle valve

543-544



Anschraubfuß
Support de fixation
Flange mount

552



SO NV 51B00

SO 09900

Ventile Edelstahl L
Vannes acier inoxydable L
Valves stainless steel L

Handrad
Volant
Handwheel

552



SO 09950

Hochdruck-Kugelhahn SOL
Vanne à bille SOL haute pression
High pressure ball valve SOL

545-547



Ventilschilder (Satz)
Plaques signalétiques (set)
Valve labels (set)

553



SOL BV 58A21

VSD SO NV

Kegelrückschlagventil
Clapet anti-retour à siège conique
Taper seat non-return valve

548



SOL CV 53B21

Ventile Stahl
Vannes acier
Valves steel

Kegelrückschlagventil
Soupape de retenue à siège conique
Taper seat non-return valve

549-551



SO 6611

Ventile Messing M / G
Vannes laiton M / G
Valves brass M / G

Ventile Edelstahl / Edelstahl L
Vannes acier inox / inox L
Valves inox / inox L

Ventile Stahl
Vannes acier
Valves in steel



Sonderausführungen auf Anfrage:
Exécution en option sur demande:
Optional services on request:

-  Spezialreinigung - entfettet
 Traitement spécial - dégraissé
 Special treatment - degreased
-  Spezialbehandlung für Einsatz mit Sauerstoff
 Traitement spécial pour utilisation sous oxygène
 Special treatment for use with oxygen
-  Spezialbehandlung - silikonfrei
 Traitement spécial - sans silicone
 Special treatment - silicone free
-  Vorbeschichtete Gewinde PTFE-Band unwickelt
 Filetages pré enduits avec ruban en PTFE
 Pre-coated threads with PTFE-tape
-  Vorbeschichtete Gewinde mit Loctite 5061
 Filetages pré enduits avec Loctite 5061
 Pre-coated threads with Loctite 5061
-  Chemisch vernickelt
 Nickelage chimique
 Chemical nickel-plated
-  Messing bleiarml
 Laiton à faible teneur en plomb
 Low-lead brass

Bestätigungen auf www.serto.com
Confirmations sur www.serto.com
Confirmations on www.serto.com

- 
- 
- 

Sonderausführungen auf Anfrage:
Exécution en option sur demande:
Optional services on request:

-  Spezialreinigung - entfettet
 Traitement spécial - dégraissé
 Special treatment - degreased
-  Spezialbehandlung für Einsatz mit Sauerstoff
 Traitement spécial pour utilisation sous oxygène
 Special treatment for use with oxygen
-  Spezialbehandlung - silikonfrei
 Traitement spécial - sans silicone
 Special treatment - silicone free
-  Vorbeschichtete Gewinde mit Loctite 5061
 Filetages pré enduits avec Loctite 5061
 Pre-coated threads with Loctite 5061

Bestätigungen auf www.serto.com
Confirmations sur www.serto.com
Confirmations on www.serto.com

- 
- 
- 
- 

Bestätigungen auf www.serto.com
Confirmations sur www.serto.com
Confirmations on www.serto.com

- 
- 
- 

Regulier- / Feinregulierventil
Vanne de réglage / réglage fin
Regulating / fine regulating valve

SO NV 41A21/E/EB/EL
SO NV 41C21/E/EB/EL

12

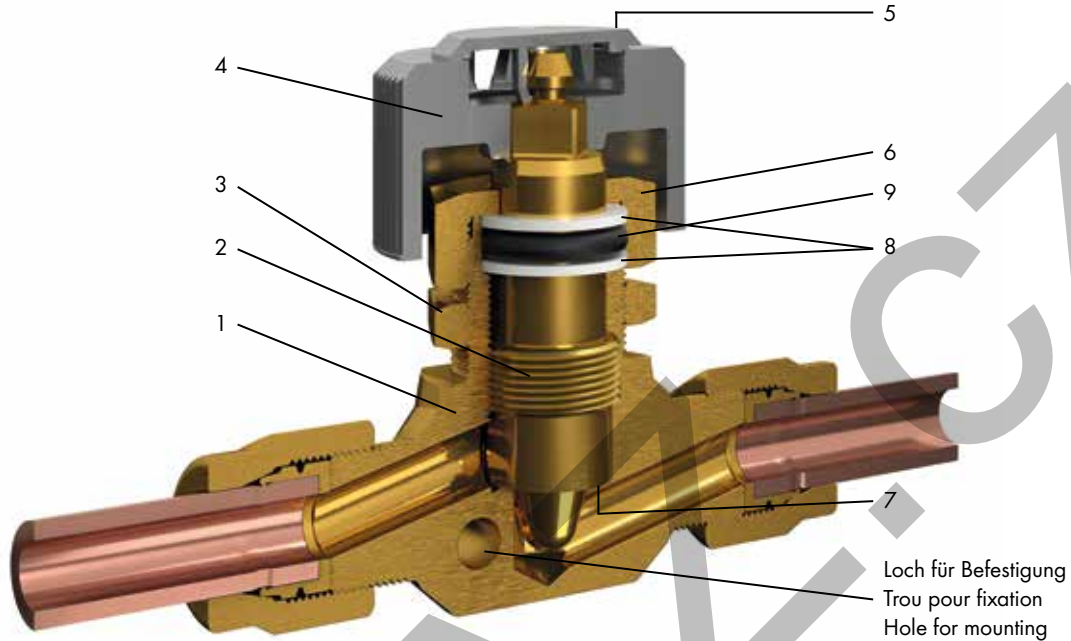

Nr. No. No.	Bezeichnung Désignation Description	Material Matériau Material	Nr. No. No.	Bezeichnung Désignation Description	Material Matériau Material	Nr. No. No.	Bezeichnung Désignation Description	Material Matériau Material
1	Ventilkörper Corps de vanne Valve body	Messing Laiton Brass	4	Handrad (grau) Volant (gris) Handwheel (grey)	Polyamid Polyamide Polyamide	7*	Spindeldichtung Joint du pointeau Spindle seal	NBR/ PTFE ¹⁾
2	Ventilspindel Pointeau de vanne Valve spindle	Messing Laiton Brass	5*	Ventilschild (grau) Plaque indicatrice (gris) Valve label (grey)	Polyamid Polyamide Polyamide	8	Dichtscheibe Rondelle de joint Sealing washer	PVDF
3	Kontermutter Contre-écrou Counter nut	Messing Laiton Brass	6*	Ventilkappe Bouchon presse-étoupe Valve cap	Messing Laiton Brass	9	Dichtung Joint Seal	NBR

Spezifikationen

Betriebsdruck (PN): 50 bar
 Temperatur: -20°C bis +80°C
 Sicherheitsfaktor: 1.5-fach

Merkmale

- Funktion: Regulier- und Absperrventil
- Einsatz: Luft, Wasser, Öle und Flüssiggase (Beständigkeit Dichtung beachten)
- Material: Messing CW617N (CuZn40Pb2)
- Besonderes: kompakte Abmessungen, hohe Zuverlässigkeit

¹⁾ Regulierventil = NBR
 Feinregulierventil = PTFE

*** Optionen**

- Nr. 5 - Ventilschild wahlweise auch in den Farben blau, rot und grün, siehe VSD SO NV
- Nr. 6 - Drehmoment für Ventilkappe bei Schalttafelmontage = 3.4 Nm
- Nr. 7 - nur Regulierventil: EPDM, FKM
- Nr. 9 - Regulier-/Feinregulierventil: EPDM, FKM
- Varianten: mit Übergangsmuffe SO 40030 oder Übergansnippel SO 40040

Spécifications

Pression de service (PN): 50 bar
 Température: -20°C à +80°C
 Facteur de sécurité: 1.5 fois

Caractéristiques

- Fonction: vanne de régulation et de retenue
- Application: air, eau, huiles et gaz liquéfiés (tenir compte de la résistance de l'étanchéité)
- Matériau: laiton CW617N (CuZn40Pb2)
- Particularités: dimensions compactes, grande fiabilité

¹⁾ Vanne de réglage = NBR
 Vanne de réglage fin = PTFE

*** Options**

- No. 5 - Plaques au choix disponible en couleurs bleu, rouge et vert, voir VSD SO NV
- No. 6 - Couple de serrage pour bouchon de vanne dans tableau de commande = 3.4 Nm
- No. 7 - Vanne de réglage: EPDM, FKM
- No. 9 - Vanne de réglage/réglage fin: EPDM, FKM
- Autres versions: avec adaptateur femelle SO 40030 ou mâle SO 40040

Specifications

Working pressure (PN): 50 bar
 Temperature: -20°C to +80°C
 Safety factor: 1.5 times

Characteristics

- Function: regulating and stop valve
- Uses: air, water, oils and liquid gases (check resistance of seal)
- Material: brass CW617N (CuZn40Pb2)
- Special: compact dimensions, high reliability

¹⁾ Regulating valve = NBR
 Fine regulating valve = PTFE

*** Options**

- No. 5 - Valve labels also available in colors blue, red and green, see VSD SO NV
- No. 6 - Torque for valve cap in panel mounting = 3.4 Nm
- No. 7 - Regulating valve only: EPDM, FKM
- No. 9 - Regulating/fine regulating valve: EPDM, FKM
- Other versions: with female SO 40030 or male adaptor SO 40040

Durchflussdiagramm

Courbe de débit

Flow rate

Regulierventile / Vannes de réglage /
Regulating valves

Feinregulierventile / Vannes de réglage fin /
Fine regulating valves

SO NV 41A21

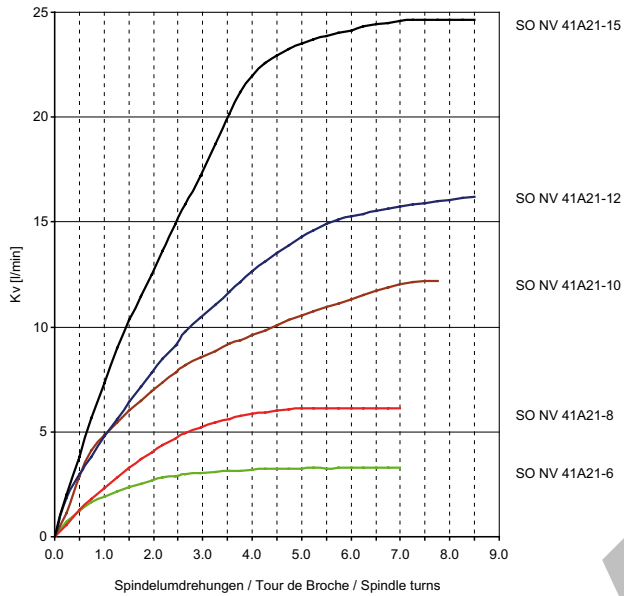

SO NV 41C21

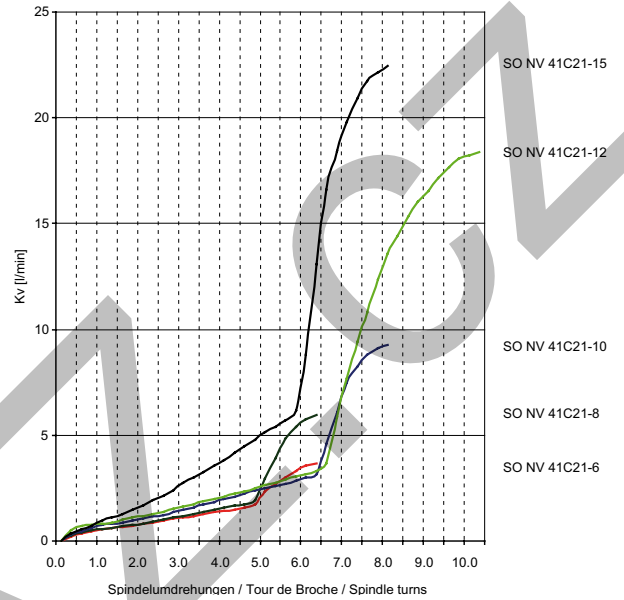

SO NV 41A21E / A21EB / A21EL

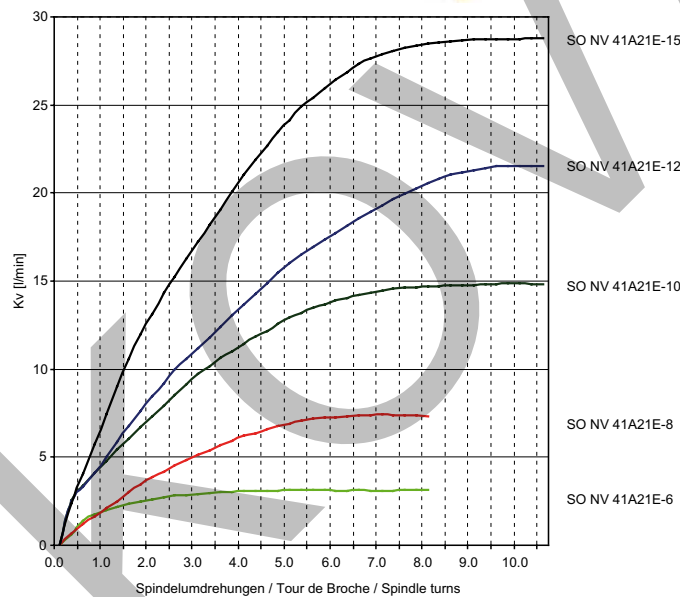

SO NV 41C21E / C21EB / 21EL

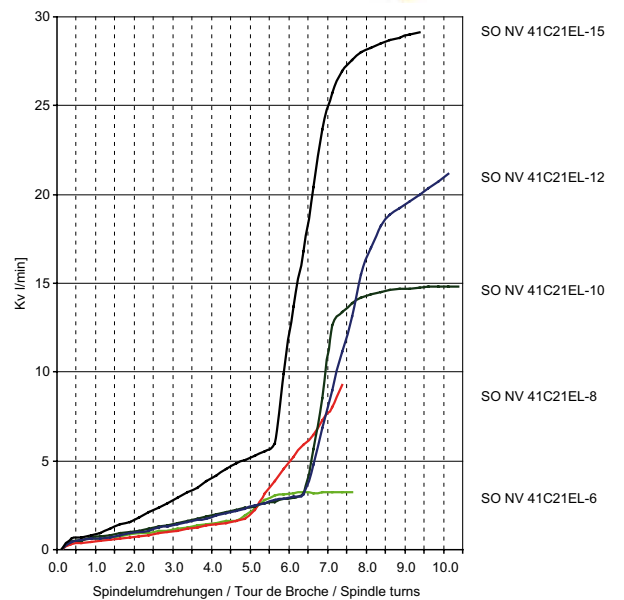

Sonderausführungen

siehe Kapitelübersicht

Exécutions en option

voir aperçu du chapitre

Optional services

see chapter overview

Zubehör

Anschraubfuß für Wandmontage der Typen SO NV 41A21 und SO NV 41C21 siehe SO 09900

Accessoires

Support de fixation pour les types SO NV 41A21 et SO NV 41C21 voir SO 09900

Accessoires

Flange mount for wall fastening for types SO NV 41A21 and SO NV 41C21 see SO 09900

Reguliertventil
Vanne de réglage
Regulating valve

12

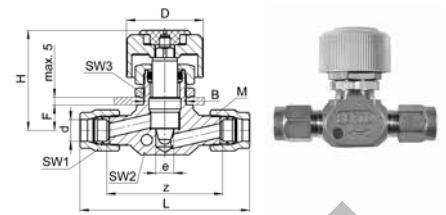

SO NV 41A21

Type-d	Mat.-Nr.	bar	M	SW1	SW2	SW3	L	D	H	B	F	z	e	kv	kg/100	
Für metrische Rohre			Pour tubes métriques					For metric tubes								
* SO NV 41A21-4	028.0000.040	50	10x1.0	12	14	19	61.0	26.0	47.0	16.5	10.0	46.0	3.4	3.0	10.600	
* SO NV 41A21-5	028.0000.050	50	10x1.0	12	14	19	61.0	26.0	47.0	16.5	10.0	46.0	4.0	3.0	10.500	
SO NV 41A21-6	028.0000.060	50	10x1.0	12	14	19	61.0	26.0	47.0	16.5	10.0	46.5	4.0	3.0	10.500	
SO NV 41A21-8	028.0000.080	50	12x1.0	14	14	19	62.5	26.0	47.0	16.5	10.0	46.5	5.0	6.0	11.300	
SO NV 41A21-10	028.0000.100	50	14x1.0	17	18	24	75.5	36.0	54.5	20.5	12.0	54.5	6.5	12.0	21.800	
SO NV 41A21-12	028.0000.120	50	16x1.0	19	18	24	86.5	36.0	56.5	20.5	14.0	62.5	8.0	16.0	25.700	
* SO NV 41A21-13	028.0000.130	50	20x1.5	24	22	27	92.0	36.0	66.0	24.5	15.0	67.0	10.0	24.5	42.000	
SO NV 41A21-14	028.0000.140	50	20x1.5	24	22	27	92.0	36.0	66.0	24.5	15.0	67.0	10.0	24.5	41.800	
SO NV 41A21-15	028.0000.150	50	20x1.5	24	22	27	92.0	36.0	66.0	24.5	15.0	67.0	10.0	24.5	41.200	
Für Zollrohre			Pour tubes pouces					For inch tubes								
SO NV 41A21-6,35	028.0000.063	50	10x1.0	12	14	19	61.0	26.0	47.0	16.5	10.0	46.0	4.0	3.0	10.400	
SO NV 41A21-9,52	028.0000.095	50	14x1.0	17	18	24	75.5	36.0	54.5	20.5	12.0	54.5	6.5	12.0	21.700	
* SO NV 41A21-12,7	028.0000.127	50	20x1.5	24	22	27	92.0	36.0	66.0	24.5	15.0	67.0	10.0	24.5	42.000	

Umrechnung für "d" bei Zollrohren:
 6,35 = 1/4
 9,52 = 3/8
 12,7 = 1/2

Conversion de "d" pour tubes en pouces:
 6,35 = 1/4
 9,52 = 3/8
 12,7 = 1/2

Conversion for "d" for inch tubes:
 6,35 = 1/4
 9,52 = 3/8
 12,7 = 1/2

KONVART

d=Rohrassen-ø
 e=kleinste Bohrung
 kv=Kenngröße für das Durchflussverhalten (l/min)
 L=Mass in montiertem Zustand
 H=Ventil geöffnet
 *=mit reduziertem Klemmring

d=ø extérieur du tube
 e=ø-min. de passage
 kv=facteur d'écoulement (l/min)
 L=après montage
 H=vanne ouvert
 *=avec bague de serrage de réduction

d=tube outside diameter
 e=minimum bore
 kv=flow factor (l/min)
 L=installed length
 H=valve opened
 *=with reduced compression ferrule

Regulierventil

mit Übergangsmuffe SO 40030

Vanne de réglage

avec adaptateur femelle SO 40030

Regulating valve

with female adaptor SO 40030

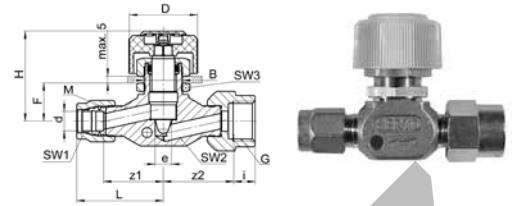

SO NV 41A30

Type -d-G	Mat.-Nr.	bar	M	SW1	SW2	SW3	L	H	B	F	i	z1	z2	e	kv	kg/100	
Für metrische Rohre		Pour tubes métriques						For metric tubes									
G=Rohrgewinde (zylindrisch)		G=Filetage-gaz BSP (cylindrique)						G=BSP thread (parallel)									
* SO NV 41A30-4-1/8	028.0200.060	50	10x1.0	12	14	19	30.5	47.0	16.5	10.0	10.0	23.0	26.0	3.4	3.0	11.330	
* SO NV 41A30-5-1/8	028.0200.082	50	10x1.0	12	14	19	30.5	47.0	16.5	10.0	10.0	23.0	26.0	4.0	3.0	11.330	
SO NV 41A30-6-1/8	028.0200.100	50	10x1.0	12	14	19	30.5	47.0	16.5	10.0	10.0	23.0	26.0	4.0	3.0	11.330	
SO NV 41A30-6-1/4	028.0200.110	50	10x1.0	12	14	19	30.5	47.0	16.5	10.0	11.0	23.0	26.0	4.0	3.0	12.190	
SO NV 41A30-6-3/8	028.0200.120	50	10x1.0	12	14	19	30.5	47.0	16.5	10.0	12.0	23.0	26.0	4.0	3.0	14.460	
SO NV 41A30-8-1/8	028.0200.160	50	12x1.0	14	14	19	31.0	47.0	16.5	10.0	10.0	23.0	26.0	5.0	6.0	12.970	
SO NV 41A30-8-1/4	028.0200.170	50	12x1.0	14	14	19	31.0	47.0	16.5	10.0	11.0	23.0	27.0	5.0	6.0	12.760	
SO NV 41A30-8-3/8	028.0200.180	50	12x1.0	14	14	19	31.0	47.0	16.5	10.0	12.0	23.0	26.0	5.0	6.0	14.960	
SO NV 41A30-10-1/4	028.0200.270	50	14x1.0	17	18	24	37.0	54.5	20.5	12.0	11.0	27.0	30.0	6.5	12.0	22.000	
SO NV 41A30-10-3/8	028.0200.280	50	14x1.0	17	18	24	37.0	54.5	20.5	12.0	12.0	27.0	30.0	6.5	12.0	24.670	
* SO NV 41A30-10-1/2	028.0200.285	50	16x1.0	19	18	24	42.0	56.5	20.5	14.0	14.0	31.0	34.0	8.0	16.0	26.186	
SO NV 41A30-12-1/4	028.0200.380	50	16x1.0	19	18	24	42.0	56.5	20.5	14.0	11.0	31.0	34.0	8.0	16.0	26.140	
SO NV 41A30-12-3/8	028.0200.390	50	16x1.0	19	18	24	42.0	56.5	20.5	14.0	12.0	31.0	34.0	8.0	16.0	27.450	
SO NV 41A30-12-1/2	028.0200.400	50	16x1.0	19	18	24	42.0	56.5	20.5	14.0	14.0	31.0	34.0	8.0	16.0	30.630	
SO NV 41A30-14-1/2	028.0200.504	50	20x1.5	24	22	27	46.0	66.0	24.5	15.0	14.0	33.5	37.0	10.0	24.5	43.770	
SO NV 41A30-15-1/2	028.0200.534	50	20x1.5	27	22	27	46.0	66.0	24.5	15.0	14.0	33.5	37.0	10.0	24.5	44.090	
Für Zollrohre		Pour tubes pouces						For inch tubes									
SO NV 41A30-6,35-1/8	028.0200.135	50	10x1.0	12	14	19	30.5	47.0	16.5	10.0	10.0	23.0	26.0	4.0	3.0	11.340	
SO NV 41A30-9,52-1/4	028.0200.230	50	14x1.0	17	18	24	37.0	54.5	20.5	12.0	10.0	27.0	30.0	6.5	12.0	21.940	
SO NV 41A30-9,52-3/8	028.0200.235	50	14x1.0	17	18	24	37.0	54.5	20.5	12.0	12.0	27.0	30.0	6.5	12.0	24.610	
* SO NV 41A30-12,7-3/8	028.0200.432	50	20x1.5	24	22	27	46.0	66.0	24.5	15.0	12.0	33.5	37.0	10.0	24.5	42.060	
* SO NV 41A30-12,7-1/2	028.0200.434	50	20x1.5	24	22	27	46.0	66.0	24.5	15.0	14.0	33.5	37.0	10.0	24.5	44.090	
* SO NV 41A30-12,7-3/4	028.0200.436	50	20x1.5	24	22	27	46.0	66.0	24.5	15.0	17.0	33.5	37.0	10.0	24.5	47.940	

Umrechnung für "d" bei Zollrohren:

6,35 = 1/4
9,52 = 3/8
12,7 = 1/2

Conversion de "d" pour tubes en pouces:

6,35 = 1/4
9,52 = 3/8
12,7 = 1/2

Conversion for "d" for inch tubes:

6,35 = 1/4
9,52 = 3/8
12,7 = 1/2

D = ø 26 mm ≤ Anschlussgröße 8
ø 36 mm ≥ Anschlussgröße 9,52

D = ø 26 mm ≤ Dimension 8
ø 36 mm ≥ Dimension 9,52

D = ø 26 mm ≤ Dimension 8
ø 36 mm ≥ Dimension 9,52

Montagehinweis: Muffe ist handfest montiert. Bei Endmontage mit 1/4 Umdrehung anziehen.

Wir empfehlen eine zusätzliche Schmierung auf der Planfläche.

Note d'installation: L'adaptateur femelle est monté serré à la main. Pour le montage final, serrer avec 1/4 de tour.

Nous recommandons une lubrification supplémentaire sur la surface plane.

Assembly information: Female adaptor is mounted finger-tight. For final assembly, tighten with 1/4 turn.

We recommend additional lubrication on the plane surface.

d=Rohrassen-ø
e=kleinste Bohrung
kv=Kenngröße für das Durchflussverhalten (l/min)
L=Mass in montiertem Zustand
H=Ventil geöffnet
*=mit reduziertem Klemmring

d=ø extérieur du tube
e=ø-min. de passage
kv=facteur d'écoulement (l/min)
L=après montage
H=vanne ouvert
*=avec bague de serrage de réduction

d=tube outside diameter
e=minimum bore
kv=flow factor (l/min)
L=installed length
H=valve opened
*=with reduced compression ferrule

Regulierventil

mit Übergangsnippel SO 40040

Vanne de réglage

avec adaptateur mâle SO 40040

Regulating valve

with male adaptor SO 40040

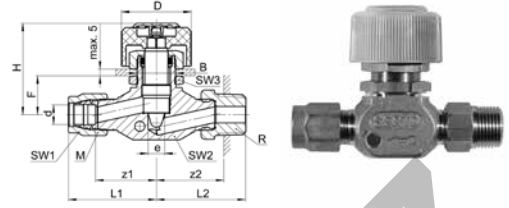
SO NV 41A40

Type -d-R		bar	M	SW1	SW2	SW3	L1	L2	H	B	F	z1	z2	e	kv	kg/100	
Für metrische Rohre		Pour tubes métriques						For metric tubes									
R=Rohrgewinde (kegelig)		R=Filetage-gaz BSP (conique)						R=BSP thread (tapered)									
*	SO NV 41A40-4-1/8	028.0300.060	50	10x1.0	12	14	19	30.5	33.0	47.0	16.5	10.0	23.0	26.5	3.4	3.0	10.460
*	SO NV 41A40-4-1/4	028.0300.065	50	10x1.0	12	14	19	30.5	37.0	47.0	16.5	10.0	23.0	27.5	3.4	3.0	11.510
*	SO NV 41A40-4-3/8	028.0300.068	50	10x1.0	12	14	19	30.5	36.0	47.0	16.5	10.0	23.0	26.0	3.4	3.0	12.690
*	SO NV 41A40-5-1/8	028.0300.082	50	10x1.0	12	14	19	30.5	33.0	47.0	16.5	10.0	23.0	26.5	4.0	3.0	10.460
*	SO NV 41A40-5-1/4	028.0300.084	50	10x1.0	12	14	19	30.5	37.0	47.0	16.5	10.0	23.0	27.5	4.0	3.0	11.510
	SO NV 41A40-6-1/8	028.0300.100	50	10x1.0	12	14	19	30.5	33.0	47.0	16.5	10.0	23.0	26.5	4.0	3.0	10.460
	SO NV 41A40-6-1/4	028.0300.110	50	10x1.0	12	14	19	30.5	37.0	47.0	16.5	10.0	23.0	27.5	4.0	3.0	11.510
	SO NV 41A40-6-3/8	028.0300.120	50	10x1.0	12	14	19	30.5	36.0	47.0	16.5	10.0	23.0	26.0	4.0	3.0	12.690
	SO NV 41A40-8-1/8	028.0300.160	50	12x1.0	14	14	19	31.0	33.0	47.0	16.5	10.0	23.0	26.5	5.0	6.0	11.170
	SO NV 41A40-8-1/4	028.0300.170	50	12x1.0	14	14	19	31.0	37.0	47.0	16.5	10.0	23.0	27.5	5.0	6.0	11.700
	SO NV 41A40-8-3/8	028.0300.180	50	12x1.0	14	14	19	31.0	37.0	47.0	16.5	10.0	23.0	27.0	5.0	6.0	13.150
	SO NV 41A40-10-1/4	028.0300.270	50	14x1.0	17	18	24	37.0	41.0	54.5	20.5	12.0	27.0	31.5	6.5	12.0	21.620
	SO NV 41A40-10-3/8	028.0300.280	50	14x1.0	17	18	24	37.0	41.0	54.5	20.5	12.0	27.0	31.0	6.5	12.0	22.350
	SO NV 41A40-10-1/2	028.0300.285	50	14x1.0	17	18	24	37.0	44.0	54.5	20.5	12.0	27.0	31.0	6.5	12.0	24.940
	SO NV 41A40-12-1/4	028.0300.380	50	16x1.0	19	18	24	42.0	46.0	56.5	20.5	14.0	31.0	36.5	8.0	16.0	25.470
	SO NV 41A40-12-3/8	028.0300.390	50	16x1.0	19	18	24	42.0	46.0	56.5	20.5	14.0	31.0	36.0	8.0	16.0	26.230
	SO NV 41A40-12-1/2	028.0300.400	50	16x1.0	19	18	24	42.0	49.0	56.5	20.5	14.0	31.0	36.0	8.0	16.0	28.200
	SO NV 41A40-14-1/2	028.0300.504	50	20x1.5	24	22	27	46.0	50.0	66.0	24.5	15.0	33.5	37.0	10.0	24.5	41.070
	SO NV 41A40-15-1/2	028.0300.534	50	20x1.5	24	22	27	46.0	50.0	66.0	24.5	15.0	33.5	37.0	10.0	24.5	41.390

Für Zollrohre		Pour tubes pouces						For inch tubes									
	SO NV 41A40-6,35-1/8	028.0300.135	50	10x1.0	12	14	19	30.5	33.0	47.0	16.5	10.0	23.0	26.5	4.0	3.0	10.470
	SO NV 41A40-6,35-1/4	028.0300.140	50	10x1.0	12	14	19	30.5	37.0	47.0	16.5	10.0	23.0	27.5	4.0	3.0	11.520
	SO NV 41A40-6,35-3/8	028.0300.145	50	10x1.0	12	14	19	30.5	36.0	47.0	16.5	10.0	23.0	26.0	4.0	3.0	12.700
	SO NV 41A40-9,52-1/4	028.0300.230	50	14x1.0	17	18	24	37.0	48.0	54.5	20.5	12.0	27.0	31.5	6.5	12.0	21.560
	SO NV 41A40-9,52-3/8	028.0300.235	50	14x1.0	17	18	24	37.0	41.0	54.5	20.5	12.0	27.0	31.0	6.5	12.0	22.290
	SO NV 41A40-9,52-1/2	028.0300.240	50	14x1.0	17	18	24	37.0	42.0	54.5	20.5	12.0	27.0	29.0	6.5	12.0	24.880
*	SO NV 41A40-12,7-3/8	028.0300.432	50	20x1.5	24	22	27	46.0	48.0	66.0	24.5	15.0	33.5	38.0	10.0	24.5	40.720
*	SO NV 41A40-12,7-1/2	028.0300.434	50	20x1.5	24	22	27	46.0	50.0	66.0	24.5	15.0	33.5	37.0	10.0	24.5	41.390

Umrechnung für "d" bei Zollrohren:

- 6,35 = 1/4
- 9,52 = 3/8
- 12,7 = 1/2

Conversion de "d" pour tubes en pouces:

- 6,35 = 1/4
- 9,52 = 3/8
- 12,7 = 1/2

Conversion for "d" for inch tubes:

- 6,35 = 1/4
- 9,52 = 3/8
- 12,7 = 1/2

 D = ø 26 mm ≤ Anschlussgröße 8
 ø 36 mm ≥ Anschlussgröße 9,52

 D = ø 26 mm ≤ Dimension 8
 ø 36 mm ≥ Dimension 9,52

 D = ø 26 mm ≤ Dimension 8
 ø 36 mm ≥ Dimension 9,52

Montagehinweis: Nippel ist handfest montiert. Bei Endmontage mit 1/4 Umdrehung anziehen.
 Wir empfehlen eine zusätzliche Schmierung auf der Planfläche.

Note d'installation: L'adaptateur femelle-mâle est monté serré à la main. Pour le montage final, serrer avec 1/4 de tour.
 Nous recommandons une lubrification supplémentaire sur la surface plane.

Assembly information: Male adaptor is mounted finger-tight. For final assembly, tighten with 1/4 turn.
 We recommend additional lubrication on the plane surface.

d=Rohrassen-ø
 e=kleinste Bohrung
 kv=Kenngröße für das Durchflussverhalten (l/min)
 L=Mass in montiertem Zustand
 H=Ventil geöffnet
 *=mit reduziertem Klemmring

d=ø extérieur du tube
 e=ø-min. de passage
 kv=facteur d'écoulement (l/min)
 L=après montage
 H=vanne ouvert
 *=avec bague de serrage de réduction

d=tube outside diameter
 e=minimum bore
 kv=flow factor (l/min)
 L=installed length
 H=valve opened
 *=with reduced compression ferrule

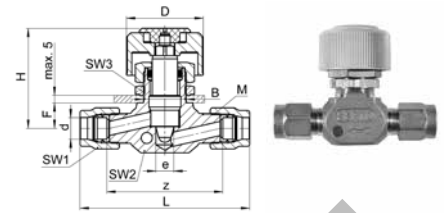
Feinreguliertventil
Vanne de réglage fin
Fine regulating valve

SO NV 41C21

Type -d	Mat.-Nr.	bar	M	SW1	SW2	SW3	L	D	H	B	F	z	e	kv	kg/100	
Für metrische Rohre			Pour tubes métriques					For metric tubes								
* SO NV 41C21-4	028.0500.040	50	10x1.0	12	14	19	61.0	26.0	47.0	16.5	10.0	46.0	3.4	3.0	10.600	
* SO NV 41C21-5	028.0500.050	50	10x1.0	12	14	19	61.0	26.0	47.0	16.5	10.0	46.0	4.0	3.0	10.500	
SO NV 41C21-6	028.0500.060	50	10x1.0	12	14	19	61.0	26.0	47.0	16.5	10.0	46.5	4.0	3.0	10.500	
SO NV 41C21-8	028.0500.080	50	12x1.0	14	14	19	62.5	26.0	47.0	16.5	10.0	46.5	5.0	6.0	11.300	
SO NV 41C21-10	028.0500.100	50	14x1.0	17	18	24	75.5	36.0	54.5	20.5	12.0	54.5	6.5	9.0	21.800	
SO NV 41C21-12	028.0500.120	50	16x1.0	19	18	24	86.5	36.0	56.5	20.5	14.0	62.5	8.0	18.5	25.700	
* SO NV 41C21-13	028.0500.130	50	20x1.5	24	22	27	92.0	36.0	66.0	24.5	15.0	67.0	10.0	22.5	42.000	
SO NV 41C21-14	028.0500.140	50	20x1.5	24	22	27	92.0	36.0	66.0	24.5	15.0	67.0	10.0	22.5	41.800	
SO NV 41C21-15	028.0500.150	50	20x1.5	24	22	27	92.0	36.0	66.0	24.5	15.0	67.0	10.0	22.5	41.200	
Für Zollrohre			Pour tubes pouces					For inch tubes								
SO NV 41C21-6,35	028.0500.063	50	10x1.0	12	14	19	61.0	26.0	47.0	16.5	10.0	46.0	4.0	3.0	10.400	
SO NV 41C21-9,52	028.0500.095	50	14x1.0	17	18	24	75.5	36.0	54.5	20.5	12.0	54.0	6.5	9.0	21.700	
* SO NV 41C21-12,7	028.0500.127	50	20x1.5	24	22	27	92.0	36.0	66.0	24.5	15.0	67.0	10.0	22.5	42.000	

Umrechnung für "d" bei Zollrohren:

 6,35 = 1/4
 9,52 = 3/8
 12,7 = 1/2

Conversion de "d" pour tubes en pouces:

 6,35 = 1/4
 9,52 = 3/8
 12,7 = 1/2

Conversion for "d" for inch tubes:

 6,35 = 1/4
 9,52 = 3/8
 12,7 = 1/2

d=Rohrassen-ø

e=kleinste Bohrung

kv=Kenngröße für das Durchflussverhalten (l/min)

L=Mass in montiertem Zustand

H=Ventil geöffnet

*=mit reduziertem Klemmring

d=ø extérieur du tube

e=ø-min. de passage

kv=facteur d'écoulement (l/min)

L=après montage

H=vanne ouvert

*=avec bague de serrage de réduction

d=tube outside diameter

e=minimum bore

kv=flow factor (l/min)

L=installed length

H=valve opened

*=with reduced compression ferrule

Regulier-Eckventil

Vanne-équerre de réglage

Elbow regulating valve

12

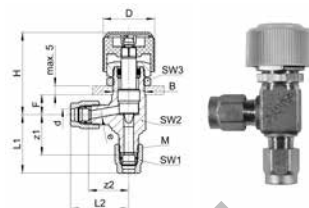

SO NV 41A21E

Type-d	Mat.-Nr.	bar	M	SW1	SW2	SW3	L1	L2	H	B	F	z1	z2	e	kv	kg/100	
Für metrische Rohre			Pour tubes métriques						For metric tubes								
* SO NV 41A21E-4	028.1500.040	50	10x1.0	12	14	19	27.5	27.5	41.0	16.5	10.0	20.0	20.0	3.4	3.5	10.500	
* SO NV 41A21E-5	028.1500.050	50	10x1.0	12	14	19	27.5	27.5	41.0	16.5	10.0	20.0	20.0	4.0	3.5	10.400	
SO NV 41A21E-6	028.1500.060	50	10x1.0	12	14	19	27.5	27.5	41.0	16.5	10.0	20.0	20.0	4.0	3.5	10.300	
SO NV 41A21E-8	028.1500.080	50	12x1.0	14	14	19	29.0	29.0	41.0	16.5	10.0	21.0	21.0	4.8	7.5	11.400	
SO NV 41A21E-10	028.1500.100	50	14x1.0	17	19	24	35.0	35.0	45.0	20.5	12.0	24.0	24.0	6.5	15.0	20.500	
SO NV 41A21E-12	028.1500.120	50	16x1.0	19	19	24	36.5	36.5	45.0	20.5	12.0	24.0	24.0	8.3	21.5	22.100	
SO NV 41A21E-14	028.1500.140	50	20x1.5	24	22	27	40.0	40.0	53.0	24.5	15.0	27.5	27.5	8.3	29.0	36.600	
SO NV 41A21E-15	028.1500.150	50	20x1.5	24	22	27	40.0	40.0	53.0	24.5	15.0	27.5	27.5	10.8	29.0	36.300	
Für Zollrohre			Pour tubes pouces						For inch tubes								
SO NV 41A21E-6,35	028.1500.063	50	10x1.0	12	14	19	27.5	27.5	41.0	16.5	10.0	20.0	20.0	4.0	3.5	10.300	
SO NV 41A21E-9,52	028.1500.095	50	14x1.0	17	19	24	35.0	35.0	45.0	20.5	12.0	24.0	24.0	6.5	15.0	20.600	
* SO NV 41A21E-12,7	028.1500.127	50	20x1.5	24	22	27	40.0	40.0	53.0	24.5	15.0	27.5	27.5	10.8	29.0	37.100	

Umrechnung für "d" bei Zollrohren:

6,35 = 1/4
 9,52 = 3/8
 12,7 = 1/2

Conversion de "d" pour tubes en pouces:

6,35 = 1/4
 9,52 = 3/8
 12,7 = 1/2

Conversion for "d" for inch tubes:

6,35 = 1/4
 9,52 = 3/8
 12,7 = 1/2

D = ø 26 mm ≤ Anschlussgrösse 8
 ø 36 mm ≥ Anschlussgrösse 9,52

D = ø 26 mm ≤ Dimension 8
 ø 36 mm ≥ Dimension 9,52

D = ø 26 mm ≤ Dimension 8
 ø 36 mm ≥ Dimension 9,52

d=Rohrassen-ø
 e=kleinste Bohrung
 kv=Kenngrösse für das Durchflussverhalten (l/min)
 L=Mass in montiertem Zustand
 H=Ventil geöffnet
 *=mit reduziertem Klemmring

d=ø extérieur du tube
 e=ø-min. de passage
 kv=facteur d'écoulement (l/min)
 L=après montage
 H=vanne ouvert
 *=avec bague de serrage de réduction

d=tube outside diameter
 e=minimum bore
 kv=flow factor (l/min)
 L=installed length
 H=valve opened
 *=with reduced compression ferrule

Regulier-Eckventil

mit Übergangsmuffe SO 40030

Vanne-équerre de réglage

avec adaptateur femelle SO 40030

Elbow regulating valve

with female adaptor SO 40030

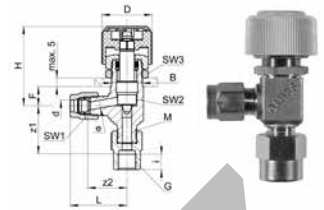
SO NV 41A30E

Type -d-G	Mat.-Nr.	bar	M	SW1	SW2	SW3	L	H	B	F	i	z1	z2	e	kv	kg/100
Für metrische Rohre				Pour tubes métriques								For metric tubes				
G=Rohrgewinde (zylindrisch)				G=Filetage-gaz BSP (cylindrique)								G=BSP thread (parallel)				
* SO NV 41A30E-4-1/8	028.1700.060	50	10x1.0	12	14	19	27.5	46.0	16.5	10.0	10.0	23.0	20.0	3.4	3.5	11.600
* SO NV 41A30E-5-1/8	028.1700.082	50	10x1.0	12	14	19	27.5	46.0	16.5	10.0	10.0	23.0	20.0	4.0	3.5	11.610
SO NV 41A30E-6-1/8	028.1700.100	50	10x1.0	12	14	19	27.5	46.0	16.5	10.0	10.0	23.0	20.0	4.0	3.5	11.330
SO NV 41A30E-6-1/4	028.1700.110	50	10x1.0	12	14	19	27.5	46.0	16.5	10.0	11.0	23.0	20.0	4.0	3.5	12.190
SO NV 41A30E-6-3/8	028.1700.120	50	10x1.0	12	14	19	27.5	46.0	16.5	10.0	12.0	23.0	20.0	4.0	3.5	14.460
SO NV 41A30E-8-1/8	028.1700.160	50	12x1.0	14	14	19	29.0	46.0	16.5	10.0	10.0	24.0	21.0	4.8	7.5	13.070
SO NV 41A30E-8-1/4	028.1700.170	50	12x1.0	14	14	19	29.0	46.0	16.5	10.0	11.0	25.0	21.0	4.8	7.5	12.820
SO NV 41A30E-8-3/8	028.1700.180	50	12x1.0	14	14	19	29.0	46.0	16.5	10.0	12.0	24.0	21.0	4.8	7.5	15.060
SO NV 41A30E-10-1/4	028.1700.270	50	14x1.0	17	19	24	35.0	54.0	20.5	12.0	11.0	27.0	24.0	6.5	15.0	20.700
SO NV 41A30E-10-3/8	028.1700.280	50	14x1.0	17	19	24	35.0	54.0	20.5	12.0	12.0	28.0	24.0	6.5	15.0	23.370
* SO NV 41A30E-10-1/2	028.1700.285	50	16x1.0	19	19	24	36.5	54.0	20.5	12.0	14.0	27.0	24.0	8.3	15.0	22.586
SO NV 41A30E-12-1/4	028.1700.380	50	16x1.0	19	19	24	36.5	54.0	20.5	12.0	11.0	27.0	24.0	8.3	21.5	22.540
SO NV 41A30E-12-3/8	028.1700.390	50	16x1.0	19	19	24	36.5	54.0	20.5	12.0	12.0	27.0	24.0	8.3	21.5	23.850
SO NV 41A30E-12-1/2	028.1700.400	50	16x1.0	19	19	24	36.5	54.0	20.5	12.0	14.0	27.0	24.0	8.3	21.5	27.030
SO NV 41A30E-14-1/2	028.1700.504	50	20x1.5	24	22	27	40.0	66.0	24.5	15.0	14.0	30.0	27.0	10.8	29.0	38.870
SO NV 41A30E-15-1/2	028.1700.534	50	20x1.5	24	22	27	40.0	66.0	24.5	15.0	14.0	30.0	27.0	10.8	29.0	39.190
Für Zollrohre				Pour tubes pouces								For inch tubes				
SO NV 41A30E-6,35-1/8	028.1700.135	50	10x1.0	12	14	19	27.5	46.0	16.5	10.0	10.0	23.0	20.0	4.0	3.5	11.140
SO NV 41A30E-6,35-1/4	028.1700.140	50	10x1.0	12	14	19	27.5	46.0	16.5	10.0	11.0	23.0	20.0	4.0	3.5	12.000
SO NV 41A30E-6,35-3/8	028.1700.145	50	10x1.0	12	14	19	27.5	46.0	16.5	10.0	12.0	23.0	20.0	4.0	3.5	14.270
SO NV 41A30E-9,52-1/4	028.1700.230	50	14x1.0	17	19	24	35.0	54.0	20.5	12.0	11.0	27.0	24.0	6.5	15.0	20.740
SO NV 41A30E-9,52-3/8	028.1700.235	50	14x1.0	17	19	24	35.0	54.0	20.5	12.0	12.0	28.0	24.0	6.5	15.0	23.410

Umrechnung für "d" bei Zollrohren:

$$6,35 = 1/4$$

$$9,52 = 3/8$$

Conversion de "d" pour tubes en pouces:

$$6,35 = 1/4$$

$$9,52 = 3/8$$

Conversion for "d" for inch tubes:

$$6,35 = 1/4$$

$$9,52 = 3/8$$

 D = \varnothing 26 mm \leq Anschlussgröße 8
 \varnothing 36 mm \geq Anschlussgröße 9,52

 D = \varnothing 26 mm \leq Dimension 8
 \varnothing 36 mm \geq Dimension 9,52

 D = \varnothing 26 mm \leq Dimension 8
 \varnothing 36 mm \geq Dimension 9,52

Montagehinweis: Muffe ist handfest montiert. Bei Endmontage mit 1/4 Umdrehung anziehen.

Wir empfehlen eine zusätzliche Schmierung auf der Planfläche.

Note d'installation: L'adaptateur femelle est monté serré à la main. Pour le montage final, serrer avec 1/4 de tour.

Nous recommandons une lubrification supplémentaire sur la surface plane.

Assembly information: Female adaptor is mounted finger-tight. For final assembly, tighten with 1/4 turn.

We recommend additional lubrication on the plane surface.

 d=Rohrassen- \varnothing
 e=kleinste Bohrung
 kv=Kenngröße für das Durchflussverhalten (l/min)
 L=Mass in montiertem Zustand
 H=Ventil geöffnet
 *=mit reduziertem Klemmring

 d= \varnothing extérieur du tube
 e= \varnothing -min. de passage
 kv=facteur d'écoulement (l/min)
 L=après montage
 H=vanne ouvert
 *=avec bague de serrage de réduction

 d=tube outside diameter
 e=minimum bore
 kv=flow factor (l/min)
 L=installed length
 H=valve opened
 *=with reduced compression ferrule

Regulier-Eckventil

mit Übergangsnippel SO 40040

Vanne-équerre de réglage

avec adaptateur mâle SO 40040

Elbow regulating valve

with male adaptor SO 40040

SO NV 41A40E

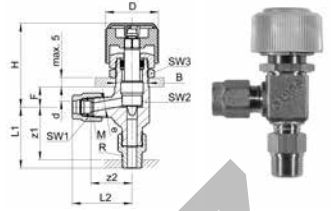

Type -d-R	Mat.-Nr.	bar	M	SW1	SW2	SW3	L1	L2	H	B	F	z1	z2	e	kv	kg/100
Für metrische Rohre R=Rohrgewinde (kegelig)			Pour tubes métriques R=Filetage-gaz BSP (conique)							For metric tubes R=BSP thread (tapered)						
* SO NV 41A40E-4-1/4	028.1800.065	50	10x1.0	12	14	19	34.0	27.5	42.0	16.5	10.0	26.0	20.0	3.4	3.5	11.780
* SO NV 41A40E-5-1/4	028.1800.084	50	10x1.0	12	14	19	34.0	27.5	42.0	16.5	10.0	26.0	20.0	4.0	3.5	11.750
SO NV 41A40E-6-1/8	028.1800.100	50	10x1.0	12	14	19	30.0	27.5	42.0	16.5	10.0	25.0	20.0	4.0	3.5	10.260
SO NV 41A40E-6-1/4	028.1800.110	50	10x1.0	12	14	19	34.0	27.5	42.0	16.5	10.0	26.0	20.0	4.0	3.5	11.310
SO NV 41A40E-6-3/8	028.1800.120	50	10x1.0	12	14	19	33.0	27.5	42.0	16.5	10.0	25.0	20.0	4.0	3.5	12.490
SO NV 41A40E-8-1/8	028.1800.160	50	12x1.0	14	14	19	31.0	29.0	42.0	16.5	12.0	26.0	21.0	4.8	7.5	11.270
SO NV 41A40E-8-1/4	028.1800.170	50	12x1.0	14	14	19	35.0	29.0	42.0	16.5	12.0	27.0	21.0	4.8	7.5	11.800
SO NV 41A40E-8-3/8	028.1800.180	50	12x1.0	14	14	19	35.0	29.0	42.0	16.5	12.0	27.0	21.0	4.8	7.5	13.250
SO NV 41A40E-10-1/4	028.1800.270	50	14x1.0	17	19	24	38.0	35.0	49.0	20.5	12.0	30.0	24.0	6.5	15.0	20.320
SO NV 41A40E-10-3/8	028.1800.280	50	14x1.0	17	19	24	38.0	35.0	49.0	20.5	12.0	30.0	24.0	6.5	15.0	21.050
SO NV 41A40E-10-1/2	028.1800.285	50	14x1.0	17	19	24	39.0	35.0	49.0	20.5	12.0	29.0	24.0	6.5	15.0	23.640
SO NV 41A40E-12-1/4	028.1800.380	50	16x1.0	19	19	24	39.0	36.5	49.0	20.5	12.0	31.0	24.0	8.3	21.5	21.870
SO NV 41A40E-12-3/8	028.1800.390	50	16x1.0	19	19	24	39.0	36.5	49.0	20.5	12.0	31.0	24.0	8.3	21.5	22.630
SO NV 41A40E-12-1/2	028.1800.400	50	16x1.0	19	19	24	40.0	36.5	49.0	20.5	12.0	30.0	24.0	8.3	21.5	24.600
SO NV 41A40E-14-1/2	028.1800.504	50	20x1.5	24	22	27	44.0	40.0	57.5	24.5	15.0	34.0	27.0	10.8	29.0	36.170
SO NV 41A40E-15-1/2	028.1800.534	50	20x1.5	24	22	27	44.0	40.0	57.5	24.5	15.0	34.0	27.0	10.8	29.0	36.490
Für Zollrohre			Pour tubes pouces							For inch tubes						
SO NV 41A40E-9,52-1/4	028.1800.230	50	14x1.0	17	19	24	38.0	35.0	49.0	20.5	12.0	30.0	24.0	6.5	15.0	20.360
SO NV 41A40E-9,52-3/8	028.1800.235	50	14x1.0	17	19	24	38.0	35.0	49.0	20.5	12.0	30.0	24.0	6.5	15.0	21.090
SO NV 41A40E-9,52-1/2	028.1800.240	50	14x1.0	17	19	24	39.0	35.0	49.0	20.5	12.0	29.0	24.0	6.5	15.0	23.680

Umrechnung für "d" bei Zollrohren:
9,52 = 3/8

Conversion de "d" pour tubes en pouces:
9,52 = 3/8

Conversion for "d" for inch tubes:
9,52 = 3/8

D = ø 26 mm ≤ Anschlussgröße 8
ø 36 mm ≥ Anschlussgröße 9,52

D = ø 26 mm ≤ Dimension 8
ø 36 mm ≥ Dimension 9,52

D = ø 26 mm ≤ Dimension 8
ø 36 mm ≥ Dimension 9,52

Montagehinweis: Nippel ist handfest montiert. Bei Endmontage mit 1/4 Umdrehung anziehen.

Wir empfehlen eine zusätzliche Schmierung auf der Planfläche.

Note d'installation: L'adaptateur femelle-mâle est monté serré à la main. Pour le montage final, serrer avec 1/4 de tour.

Nous recommandons une lubrification supplémentaire sur la surface plane.

Assembly information: Male adaptor is mounted finger-tight. For final assembly, tighten with 1/4 turn.

We recommend additional lubrication on the plane surface.

d=Rohrassen-ø
e=kleinste Bohrung
kv=Kenngröße für das Durchflussverhalten (l/min)
L=Mass in montiertem Zustand
H=Ventil geöffnet
*=mit reduziertem Klemmring

d=ø extérieur du tube
e=ø-min. de passage
kv=facteur d'écoulement (l/min)
L=après montage
H=vanne ouvert
*=avec bague de serrage de réduction

d=tube outside diameter
e=minimum bore
kv=flow factor (l/min)
L=installed length
H=valve opened
*=with reduced compression ferrule

Regulier-Eckventil

mit Einschraubgewinde

Vanne-équerre de réglage

avec filetage

Elbow regulating valve

with male adaptor thread

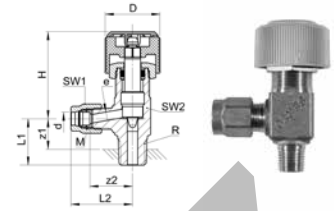

SO NV 41A21EB

Type -d -R	Mat.-Nr.	bar	M	SW1	SW2	L1	L2	D	H	z1	z2	e	kv	kg/100
Für metrische Rohre R=Rohrgewinde (kegelig)			Pour tubes métriques R=Filetage-gaz BSP (conique)						For metric tubes R=BSP thread (tapered)					
* SO NV 41A21EB-4-1/8	028.1600.060	50	10x1.0	12	14	19.0	27.5	26.0	46.0	14.0	20.0	3.4	3.5	9.500
* SO NV 41A21EB-5-1/8	028.1600.082	50	10x1.0	12	14	19.0	27.5	26.0	46.0	14.0	20.0	4.0	3.5	9.400
SO NV 41A21EB-6-1/8	028.1600.100	50	10x1.0	12	14	19.0	27.5	26.0	46.0	14.0	20.0	4.0	3.5	9.400
SO NV 41A21EB-6-1/4	028.1600.110	50	10x1.0	12	14	22.0	27.5	26.0	46.0	14.0	20.0	4.0	3.5	10.000
SO NV 41A21EB-8-1/8	028.1600.160	50	12x1.0	14	14	20.0	29.0	26.0	46.0	15.0	21.0	4.0	7.5	9.900
SO NV 41A21EB-8-1/4	028.1600.170	50	12x1.0	14	14	22.0	29.0	26.0	46.0	14.0	21.0	4.8	7.5	10.600
SO NV 41A21EB-10-1/4	028.1600.270	50	14x1.0	17	19	25.5	34.0	36.0	54.0	17.5	24.0	6.5	15.0	18.500
SO NV 41A21EB-12-1/4	028.1600.380	50	16x1.0	19	19	25.5	36.0	36.0	54.0	17.5	24.0	8.3	21.5	19.200
SO NV 41A21EB-12-3/8	028.1600.390	50	16x1.0	19	19	25.5	36.0	36.0	54.0	17.5	24.0	8.3	21.5	20.000
SO NV 41A21EB-14-1/2	028.1600.504	50	20x1.5	24	22	31.0	40.0	36.0	66.0	21.0	27.5	10.8	29.0	32.900
SO NV 41A21EB-15-1/2	028.1600.534	50	20x1.5	24	22	31.0	40.0	36.0	66.0	21.0	27.5	10.8	29.0	32.900
Für Zollrohre			Pour tubes pouces						For inch tubes					
SO NV 41A21EB-6,35-1/8	028.1600.135	50	10x1.0	12	14	19.0	27.5	26.0	46.0	14.0	20.0	4.0	3.5	9.400
SO NV 41A21EB-9,52-1/4	028.1600.230	50	14x1.0	17	19	25.5	34.0	36.0	54.0	17.5	24.0	6.5	15.0	18.600
* SO NV 41A21EB-12,7-1/2	028.1600.434	50	20x1.5	24	22	31.0	40.0	36.0	66.0	21.0	27.5	10.8	29.0	33.300

Umrechnung für "d" bei Zollrohren:

6,35 = 1/4
9,52 = 3/8
12,7 = 1/2

Conversion de "d" pour tubes en pouces:

6,35 = 1/4
9,52 = 3/8
12,7 = 1/2

Conversion for "d" for inch tubes:

6,35 = 1/4
9,52 = 3/8
12,7 = 1/2

d=Rohraussen-ø

e=kleinste Bohrung

kv=Kenngröße für das Durchflussverhalten (l/min)

L=Mass in montiertem Zustand

H=Ventil geöffnet

*=mit reduziertem Klemmring

d=ø extérieur du tube

e=ø-min. de passage

kv=facteur d'écoulement (l/min)

L=après montage

H=vanne ouvert

*=avec bague de serrage de réduction

d=tube outside diameter

e=minimum bore

kv=flow factor (l/min)

L=installed length

H=valve opened

*=with reduced compression ferrule

Regulier-Eckventil

mit Einstellzapfen

Vanne-équerre de réglage

orientable

Elbow regulating valve

adjustable

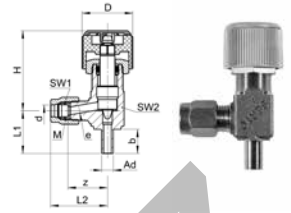
SO NV 41A21EL

Type -d -Ad	Mat.-Nr.	bar	M	SW1	SW2	L1	L2	D	H	b	z	e	kv	kg/100	
Für metrische Rohre			Pour tubes métriques					For metric tubes							
* SO NV 41A21EL-4-A6	028.1560.045	50	10x1.0	12	14	22.0	27.5	26.0	46.0	12.5	20.0	3.4	3.5	9.400	
* SO NV 41A21EL-5-A6	028.1560.053	50	10x1.0	12	14	22.0	27.5	26.0	46.0	12.5	20.0	4.0	3.5	9.400	
SO NV 41A21EL-6-A6	028.1560.060	50	10x1.0	12	14	22.0	27.5	26.0	46.0	12.5	20.0	4.0	3.5	9.400	
* SO NV 41A21EL-6-A8	028.1560.063	50	12x1.0	14	14	22.0	29.0	26.0	46.0	12.5	21.0	4.5	3.5	10.600	
SO NV 41A21EL-8-A8	028.1560.080	50	12x1.0	14	14	22.0	29.0	26.0	46.0	12.5	21.0	5.0	7.5	10.600	

Für Zollrohre

Pour tubes pouces

For inch tubes

SO NV 41A21EL-6,35-A6	028.1560.067	50	10x1.0	12	14	22.0	27.5	26.0	46.0	12.5	20.0	4.0	3.5	9.400
-----------------------	--------------	----	--------	----	----	------	------	------	------	------	------	-----	-----	-------

 Umrechnung für "d" bei Zollrohren:
 6,35 = 1/4

 Conversion de "d" pour tubes en pouces:
 6,35 = 1/4

 Conversion for "d" for inch tubes:
 6,35 = 1/4

d=Rohraussen-ø
 Ad=Aussen-ø der Andrehung
 kv=Kenngröße für das Durchflussverhalten (l/min)
 L=Mass in montiertem Zustand
 H=Ventil geöffnet
 *=mit reduziertem Klemmring

d=ø extérieur du tube
 Ad=ø extérieur de la portée cylindrique
 kv=facteur d'écoulement (l/min)
 L=après montage
 H=vanne ouvert
 *=avec bague de serrage de réduction

d=tube outside diameter
 Ad=outside diameter of cyl. stub
 kv=flow factor (l/min)
 L=installed length
 H=valve opened
 *=with reduced compression ferrule

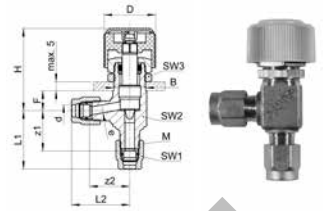
Feinregulier-Eckventil
Vanne-équerre de réglage fin
Elbow fine regulating valve

SO NV 41C21E

Type -d	Mat.-Nr.	bar	M	SW1	SW2	SW3	L1	L2	H	B	F	z1	z2	e	kv	kg/100	
Für metrische Rohre		Pour tubes métriques						For metric tubes									
* SO NV 41C21E-4	028.2000.040	50	10x1.0	12	14	19	27.5	27.5	41.0	16.5	10.0	20.0	20.0	3.4	3.0	10.500	
* SO NV 41C21E-5	028.2000.050	50	10x1.0	12	14	19	27.5	27.5	41.0	16.5	10.0	20.0	20.0	4.0	3.0	10.400	
SO NV 41C21E-6	028.2000.060	50	10x1.0	12	14	19	27.5	27.5	41.0	16.5	10.0	20.0	20.0	4.0	3.0	10.300	
SO NV 41C21E-8	028.2000.080	50	12x1.0	14	14	19	29.0	29.0	41.0	16.5	10.0	21.0	21.0	4.8	9.0	11.400	
SO NV 41C21E-10	028.2000.100	50	14x1.0	17	19	24	35.0	35.0	45.0	20.5	12.0	24.0	24.0	6.5	15.0	20.500	
SO NV 41C21E-12	028.2000.120	50	16x1.0	19	19	24	36.5	36.5	45.0	20.5	12.0	24.0	24.0	8.3	21.5	22.100	
SO NV 41C21E-14	028.2000.140	50	20x1.5	24	22	27	40.0	40.0	53.0	24.5	15.0	27.5	27.5	10.8	29.0	36.600	
SO NV 41C21E-15	028.2000.150	50	20x1.5	24	22	27	40.0	40.0	53.0	24.5	15.0	27.5	27.5	10.8	29.0	36.300	

Für Zollrohre		Pour tubes pouces						For inch tubes									
SO NV 41C21E-6,35	028.2000.063	50	10x1.0	12	14	19	27.5	27.5	41.0	16.5	10.0	20.0	20.0	4.0	3.0	10.300	
SO NV 41C21E-9,52	028.2000.095	50	14x1.0	17	19	24	35.0	35.0	45.0	20.5	12.0	24.0	24.0	6.5	15.0	20.600	
* SO NV 41C21E-12,7	028.2000.127	50	20x1.5	24	22	27	40.0	40.0	53.0	24.5	15.0	27.5	27.5	10.8	29.0	37.100	

Umrechnung für "d" bei Zollrohren:

 6,35 = 1/4
 9,52 = 3/8
 12,7 = 1/2

Conversion de "d" pour tubes en pouces:

 6,35 = 1/4
 9,52 = 3/8
 12,7 = 1/2

Conversion for "d" for inch tubes:

 6,35 = 1/4
 9,52 = 3/8
 12,7 = 1/2

 D = ø 20 mm ≤ Anschlussgröße 8
 ø 32 mm ≥ Anschlussgröße 9,52

 D = ø 20 mm ≤ Dimension 8
 ø 32 mm ≥ Dimension 9,52

 D = ø 20 mm ≤ Dimension 8
 ø 32 mm ≥ Dimension 9,52

d=Rohrassen-ø

e=kleinste Bohrung

kv=Kenngröße für das Durchflussverhalten (l/min)

L=Mass in montiertem Zustand

H=Ventil geöffnet

*=mit reduziertem Klemmring

d=ø extérieur du tube

e=ø-min. de passage

kv=facteur d'écoulement (l/min)

L=après montage

H=vanne ouvert

*=avec bague de serrage de réduction

d=tube outside diameter

e=minimum bore

kv=flow factor (l/min)

L=installed length

H=valve opened

*=with reduced compression ferrule

Feinregulier-Eckventil

mit Einschraubgewinde

Vanne-équerre de réglage fin

avec filetage

Elbow fine regulating valve

with male adaptor thread

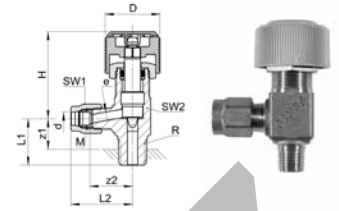
SO NV 41C21EB

Type -d-R	Mat.-Nr.	bar	M	SW1	SW2	L1	L2	D	H	z1	z2	e	kv	kg/100
Für metrische Rohre R=Rohrgewinde (kegelig)			Pour tubes métriques R=Filetage-gaz BSP (conique)						For metric tubes R=BSP thread (tapered)					
* SO NV 41C21EB-4-1/8	028.2100.060	50	10x1.0	12	14	19.0	27.5	26.0	46.0	14.0	20.0	3.4	3.0	9.500
* SO NV 41C21EB-5-1/8	028.2100.082	50	10x1.0	12	14	19.0	27.5	26.0	46.0	14.0	20.0	4.0	3.0	9.400
SO NV 41C21EB-6-1/8	028.2100.100	50	10x1.0	12	14	19.0	27.5	26.0	46.0	14.0	20.0	4.0	3.0	9.400
SO NV 41C21EB-6-1/4	028.2100.110	50	10x1.0	12	14	22.0	27.5	26.0	46.0	14.0	20.0	4.0	3.0	10.000
SO NV 41C21EB-8-1/8	028.2100.160	50	12x1.0	14	14	20.0	29.0	26.0	46.0	15.0	21.0	4.0	9.0	9.900
SO NV 41C21EB-8-1/4	028.2100.170	50	12x1.0	14	14	22.0	29.0	26.0	46.0	14.0	21.0	4.8	9.0	10.600
SO NV 41C21EB-10-1/4	028.2100.270	50	14x1.0	17	19	25.5	34.0	36.0	54.0	17.5	24.0	6.5	15.0	18.500
SO NV 41C21EB-12-1/4	028.2100.380	50	16x1.0	19	19	25.5	36.0	36.0	54.0	17.5	24.0	8.3	21.5	19.200
SO NV 41C21EB-12-3/8	028.2100.390	50	16x1.0	19	19	25.5	36.0	36.0	54.0	17.5	24.0	8.3	21.5	20.000
SO NV 41C21EB-14-1/2	028.2100.504	50	20x1.5	24	22	31.0	40.0	36.0	66.0	21.0	27.5	10.8	29.0	32.900
SO NV 41C21EB-15-1/2	028.2100.534	50	20x1.5	24	22	31.0	40.0	36.0	66.0	21.0	27.5	10.8	29.0	32.900

Für Zollrohre			Pour tubes pouces						For inch tubes					
SO NV 41C21EB-6,35-1/8	028.2100.135	50	10x1.0	12	14	19.0	27.5	26.0	46.0	14.0	20.0	4.0	3.0	9.400
SO NV 41C21EB-9,52-3/8	028.2100.230	50	14x1.0	17	19	25.5	34.0	36.0	54.0	17.5	24.0	6.5	15.0	19.200
* SO NV 41C21EB-12,7-1/2	028.2100.434	50	20x1.5	24	22	31.0	40.0	36.0	66.0	21.0	27.5	10.8	29.0	33.300

Umrechnung für "d" bei Zollrohren:

 6,35 = 1/4
 9,52 = 3/8
 12,7 = 1/2

Conversion de "d" pour tubes en pouces:

 6,35 = 1/4
 9,52 = 3/8
 12,7 = 1/2

Conversion for "d" for inch tubes:

 6,35 = 1/4
 9,52 = 3/8
 12,7 = 1/2

 d=Rohrassen-ø
 e=kleinste Bohrung
 kv=Kenngröße für das Durchflussverhalten (l/min)
 L=Mass in montiertem Zustand
 H=Ventil geöffnet
 *=mit reduziertem Klemmring

 d=ø extérieur du tube
 e=ø-min. de passage
 kv=facteur d'écoulement (l/min)
 L=après montage
 H=vanne ouvert
 *=avec bague de serrage de réduction

 d=tube outside diameter
 e=minimum bore
 kv=flow factor (l/min)
 L=installed length
 H=valve opened
 *=with reduced compression ferrule

Feinregulier-Eckventil

mit Einstellzapfen

Vanne-équerre de réglage fin

orientable

Elbow fine regulating valve

adjustable

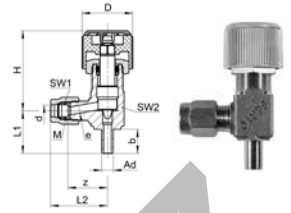
SO NV 41C21EL

Type -d -Ad	Mat.-Nr.	bar	M	SW1	SW2	L1	L2	D	H	b	z	e	kv	kg/100	
Für metrische Rohre			Pour tubes métriques					For metric tubes							
* SO NV 41C21EL-4-A6	028.2060.045	50	10x1.0	12	14	22.0	27.5	26.0	46.0	12.5	20.0	3.4	3.0	9.400	
* SO NV 41C21EL-5-A5	028.2060.053	50	10x1.0	12	14	22.0	27.5	26.0	46.0	12.5	20.0	4.0	3.0	9.400	
SO NV 41C21EL-6-A6	028.2060.060	50	10x1.0	12	14	22.0	27.5	26.0	46.0	12.5	20.0	4.0	3.0	9.400	
* SO NV 41C21EL-6-A8	028.2060.063	50	12x1.0	14	14	22.0	29.0	26.0	46.0	12.5	21.0	4.5	9.0	10.600	
SO NV 41C21EL-8-A8	028.2060.080	50	12x1.0	14	14	22.0	29.0	26.0	46.0	12.5	21.0	5.0	9.0	10.600	

Für Zollrohre

Pour tubes pouces

For inch tubes

SO NV 41C21EL-6,35-A6	028.2060.067	50	10x1.0	12	14	22.0	27.5	26.0	46.0	12.5	20.0	4.0	3.0	9.400
-----------------------	--------------	----	--------	----	----	------	------	------	------	------	------	-----	-----	-------

 Umrechnung für "d" bei Zollrohren:
 6,35 = 1/4

 Conversion de "d" pour tubes en pouces:
 6,35 = 1/4

 Conversion for "d" for inch tubes:
 6,35 = 1/4

d=Rohraussen-ø
 Ad=Aussen-ø der Andrehung
 kv=Kenngröße für das Durchflussverhalten (l/min)
 L=Mass in montiertem Zustand
 H=Ventil geöffnet
 *=mit reduziertem Klemmring

d=ø extérieur du tube
 Ad=ø extérieur de la portée cylindrique
 kv=facteur d'écoulement (l/min)
 L=après montage
 H=vanne ouvert
 *=avec bague de serrage de réduction

d=tube outside diameter
 Ad=outside diameter of cyl. stub
 kv=flow factor (l/min)
 L=installed length
 H=valve opened
 *=with reduced compression ferrule

Kegelrückschlagventil
Clapet anti-retour à siège conique
Taper seat non-return valve

**SO CV 43A21/
A30/A40**

12

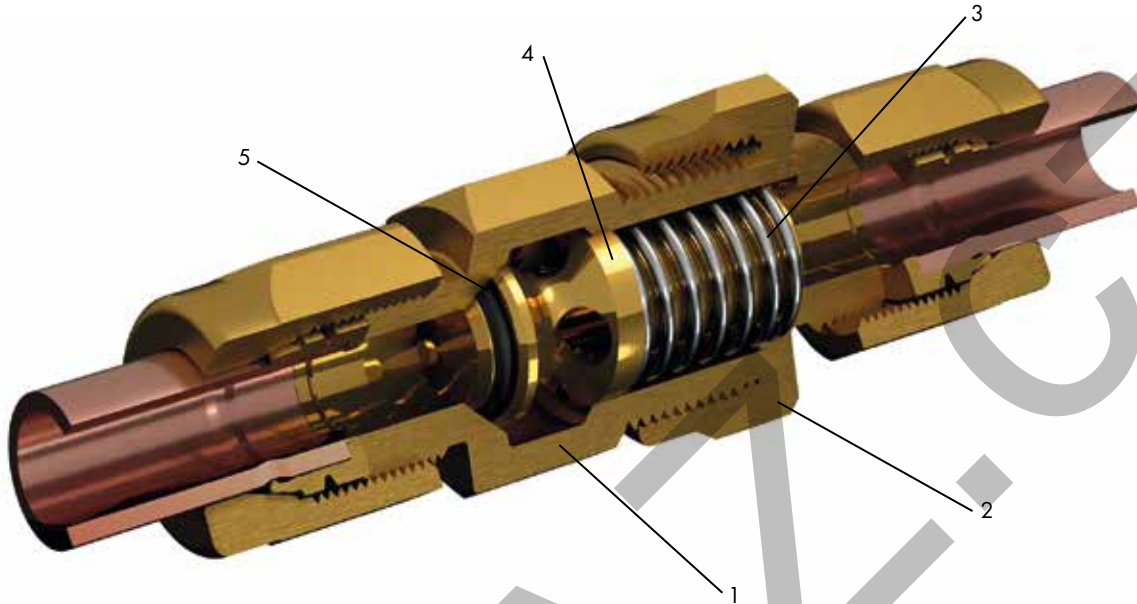

Nr. No. No.	Bezeichnung Désignation Description	Material Matériau Material	Nr. No. No.	Bezeichnung Désignation Description	Material Matériau Material	Nr. No. No.	Bezeichnung Désignation Description	Material Matériau Material
1	Ventilkegelführung Guidage cône du clapet Valve cone guide	Messing Laiton Brass	3*	Druckfeder Ressort de compression Compression spring	1.4401	5*	Dichtung Joint Seal	NBR
2	Ventilmutter Écrou du clapet Valve nut	Messing Laiton Brass	4	Ventilkegel Cône du clapet Valve cone	Messing Laiton Brass			

Spezifikationen

Betriebsdruck (PN): 50 bis 100 bar
 Temperatur: -20°C bis +80°C
 Öffnungsdruck: 0.2 bar ± 0.1 bar
 Sicherheitsfaktor: 1.5-fach

Merkmale

- Funktion: Rückflussverhinderer
- Einsatz: Luft, Wasser, Öle und Flüssiggase (Beständigkeit Dichtung beachten)
- Material: Messing CW617N (CuZn40Pb2)
- Besonderes: strömungsgünstige Konstruktion, Druckstöße werden gedämpft

*** Optionen**

- Nr. 3 - Druckfeder: Öffnungsdruck 0.5, 1, 2, 3, 5 bar ± 20 %
- Nr. 5 - Dichtung: EPDM, FKM
- Varianten: mit Übergangsmuffe SO 40030 oder Übergangsnippel SO 40040

Spécifications

Pression de service (PN): 50 à 100 bar
 Température: -20°C à +80°C
 Pression d'ouverture: 0.2 bar ± 0.1 bar
 Facteur de sécurité: 1.5 fois

Caractéristiques

- Fonction: clapet anti-retour
- Application: air, eau, huiles et gaz liquéfiés (tenir compte de la résistance de l'étanchéité)
- Matériau: laiton CW617N (CuZn40Pb2)
- Particularités: conception favorisant l'écoulement, amortit les coups de bélier

*** Options**

- No. 3 - Ressort de compression: pression d'ouverture 0.5, 1, 2, 3, 5 bar ± 20 %
- No. 5 - Joint: EPDM, FKM
- Autres versions: avec adaptateur femelle SO 40030 ou mâle SO 40040

Specifications

Working pressure (PN): 50 to 100 bar
 Temperature: -20°C to +80°C
 Opening pressure: 0.2 bar ± 0.1 bar
 Safety factor: 1.5 times

Characteristics

- Function: check valve
- Uses: air, water, oils and liquid gases (check resistance of seal)
- Material: brass CW617N (CuZn40Pb2)
- Special: flow-optimised design, damps water hammer

*** Options**

- No. 3 - Compression spring: opening pressure 0.5, 1, 2, 3, 5 bar ± 20 %
- No. 5 - Seal: EPDM, FKM
- Other versions: with female SO 40030 or male adaptor SO 40040

Durchflussdiagramm

Der Druckabfall nimmt mit zunehmendem Durchfluss überproportional zu.

Courbe de débit

La perte de pression augmente disproportionnellement avec plus de débit.

Flow rate

The pressure drop increases disproportionately with increasing flow rate.

SO CV 43A21

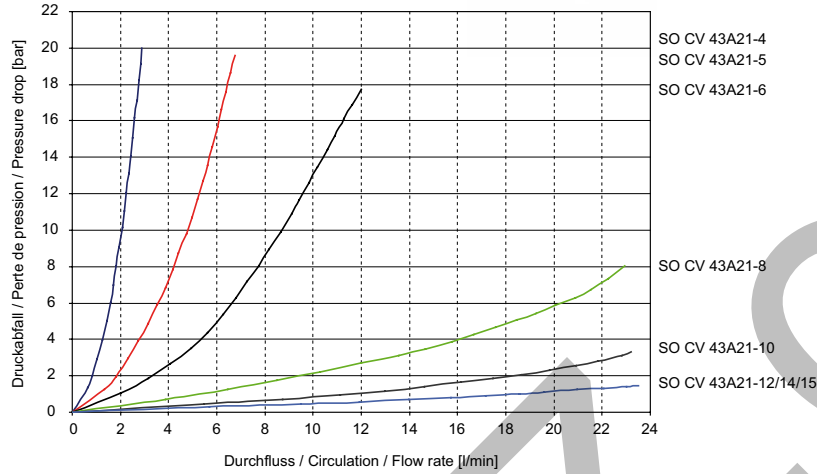

Öffnungsdruckdiagramm

Der Öffnungsdruck bewegt sich im blau skizzierten Bereich. Das Ventil schliesst im rot skizzierten Bereich.

Courbe de pression d'ouverture

La pression d'ouverture se trouve dans la zone indiquée en bleu. La vanne se ferme dans la zone indiquée en rouge.

Opening pressure diagram

The opening pressure ranges within the blue section. The valve closes within the red section.

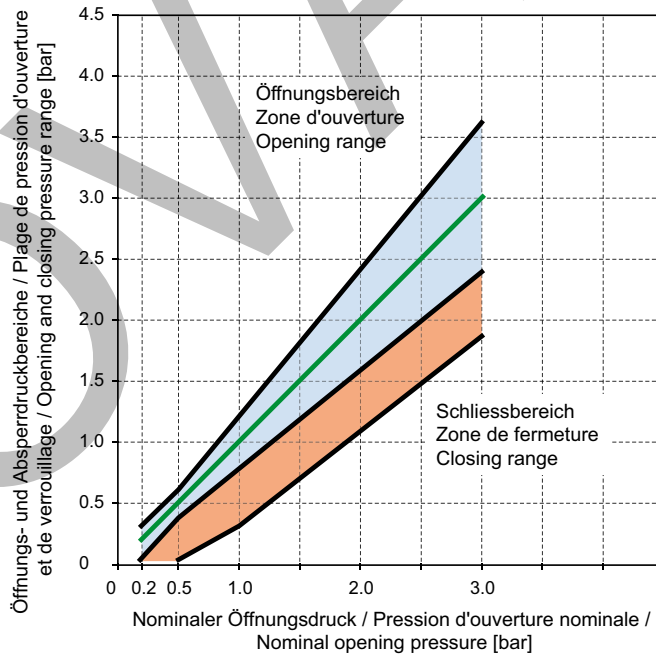

Sonderausführungen

siehe Kapitelübersicht

Exécutions en option

voir aperçu du chapitre

Optional services

see chapter overview

Kegelrückschlagventil
Clapet anti-retour à siège conique
Taper seat non-return valve

12

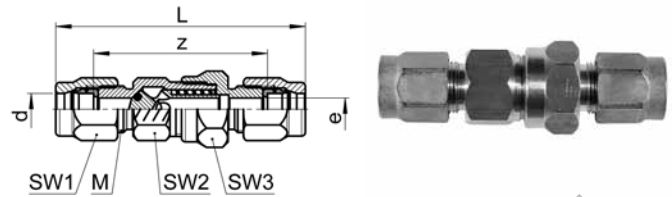
SO CV 43A21

Type-d	Mat.-Nr.	bar	M	SW1	SW2	SW3	L	z	e	kg/100	
Für metrische Rohre	Pour tubes métriques			For metric tubes							
* SO CV 43A21-4	028.3000.040	100	10x1.0	12	12	14	53.5	38.5	3.4	4.500	
* SO CV 43A21-5	028.3000.050	100	10x1.0	12	12	14	53.5	38.5	3.8	4.400	
SO CV 43A21-6	028.3000.060	100	10x1.0	12	12	14	54.0	39.0	3.8	4.300	
SO CV 43A21-8	028.3000.080	100	12x1.0	14	14	17	63.0	47.0	5.8	6.300	
SO CV 43A21-10	028.3000.100	64	14x1.0	17	19	22	71.0	51.0	7.5	12.000	
* SO CV 43A21-12	028.3000.120	50	20x1.5	24	24	27	82.5	58.0	10.0	23.800	
* SO CV 43A21-13	028.3000.130	50	20x1.5	24	24	27	82.5	58.0	11.0	23.600	
SO CV 43A21-14	028.3000.140	50	20x1.5	24	24	27	82.5	58.0	11.0	23.100	
SO CV 43A21-15	028.3000.150	50	20x1.5	24	24	27	82.5	58.0	11.0	23.000	
Für Zollrohre	Pour tubes pouces			For inch tubes							
SO CV 43A21-6,35	028.3000.063	100	10x1.0	12	12	14	54.0	39.0	3.8	4.300	
SO CV 43A21-9,52	028.3000.095	64	14x1.0	17	19	22	71.0	47.0	7.5	12.000	
* SO CV 43A21-12,7	028.3000.127	50	20x1.5	24	24	27	82.5	58.0	11.0	23.700	

Umrechnung für "d" bei Zollrohren:

 6,35 = 1/4
 9,52 = 3/8
 12,7 = 1/2

Conversion de "d" pour tubes en pouces:

 6,35 = 1/4
 9,52 = 3/8
 12,7 = 1/2

Conversion for "d" for inch tubes:

 6,35 = 1/4
 9,52 = 3/8
 12,7 = 1/2

 d=Rohraussen-ø
 e=kleinste Bohrung
 L=Mass in montiertem Zustand
 *=mit reduziertem Klemmring

 d=ø extérieur du tube
 e=ø-min. de passage
 L=après montage
 *=avec bague de serrage de réduction

 d=tube outside diameter
 e=minimum bore
 L=installed length
 *=with reduced compression ferrule

Kegelrückschlagventil

mit Übergangsmuffe SO 40030

Clapet anti-retour à siège conique

avec adaptateur femelle SO 40030

Taper seat non-return valve

with female adaptor SO 40030

SO CV 43A30

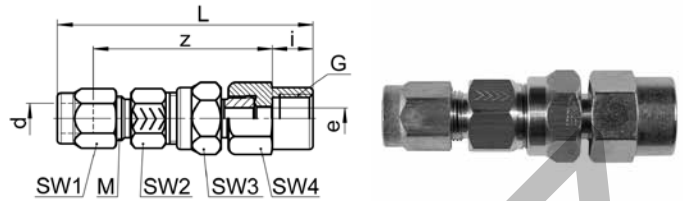

Type -d-G	Mat.-Nr.	bar	M	SW1	SW2	SW3	SW4	L	i	z	e	kg/100
G=Rohrgewinde (zylindrisch)				G=Filetage-gaz BSP (cylindrique)				G=BSP thread (parallel)				
* SO CV 43A30-4-1/4	028.3300.065	100	10x1.0	12	12	14	17	60.0	11.0	41.5	3.4	5.080
SO CV 43A30-6-1/8	028.3300.100	100	10x1.0	12	12	14	14	59.0	10.0	41.5	3.8	4.110
SO CV 43A30-6-1/4	028.3300.110	100	10x1.0	12	12	14	17	60.0	11.0	41.5	3.8	4.970
SO CV 43A30-6-3/8	028.3300.120	100	10x1.0	12	12	14	22	61.0	12.0	41.5	3.8	7.240
SO CV 43A30-8-1/8	028.3300.160	100	12x1.0	14	14	17	17	65.5	10.0	47.5	5.8	6.410
SO CV 43A30-8-1/4	028.3300.170	100	12x1.0	14	14	17	17	67.5	11.0	48.5	5.8	6.160
SO CV 43A30-8-3/8	028.3300.180	100	12x1.0	14	14	17	22	67.5	12.0	47.5	5.8	8.400
SO CV 43A30-10-1/4	028.3300.270	64	14x1.0	17	19	22	17	74.5	11.0	53.5	7.5	8.530
SO CV 43A30-10-3/8	028.3300.280	64	14x1.0	17	19	22	22	76.5	12.0	54.5	7.5	11.200
* SO CV 43A30-12-3/8	028.3300.390	50	20x1.5	24	24	27	24	86.5	12.0	61.0	10.0	17.780
* SO CV 43A30-12-1/2	028.3300.400	50	20x1.5	24	24	27	27	87.5	14.0	61.0	10.0	19.810
* SO CV 43A30-12-3/4	028.3300.405	50	20x1.5	24	24	27	32	90.5	17.0	61.0	10.0	23.660
SO CV 43A30-14-1/2	028.3300.504	50	20x1.5	24	24	27	27	87.5	14.0	61.0	11.0	19.590
SO CV 43A30-15-1/2	028.3300.534	50	20x1.5	24	24	27	27	87.5	14.0	61.0	11.0	19.270

Montagehinweis: Muffe ist handfest montiert. Bei Endmontage mit 1/4 Umdrehung anziehen.

Wir empfehlen eine zusätzliche Schmierung auf der Planfläche.

Note d'installation: L'adaptateur femelle est monté serré à la main. Pour le montage final, serrer avec 1/4 de tour.

Nous recommandons une lubrification supplémentaire sur la surface plane.

Assembly information: Female adaptor is mounted finger-tight. For final assembly, tighten with 1/4 turn.

We recommend additional lubrication on the plane surface.

d=Rohrassen- \emptyset
e=kleinste Bohrung
L=Mass in montiertem Zustand
*=mit reduziertem Klemmring

d= \emptyset extérieur du tube
e= \emptyset -min. de passage
L=après montage
*=avec bague de serrage de réduction

d=tube outside diameter
e=minimum bore
L=installed length
*=with reduced compression ferrule

Kegelrückschlagventil

mit Übergangsnippel SO 40040

Clapet anti-retour à siège conique

avec adaptateur mâle SO 40040

Taper seat non-return valve

with male adaptor SO 40040

SO CV 43A40

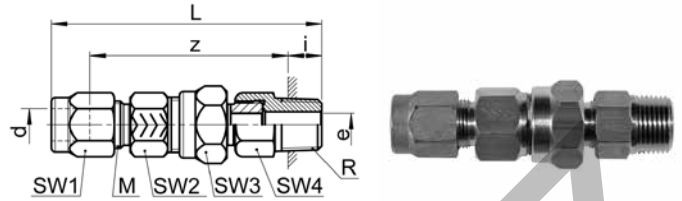

Type -d-R	Mat.-Nr.	bar	M	SW1	SW2	SW3	SW4	L	i	z	e	kg/100
R=Rohrgewinde (kegelig)				R=Filetage-gaz BSP (conique)				R=BSP thread (tapered)				
* SO CV 43A40-4-1/4	028.3400.065	100	10x1.0	12	12	14	14	58.5	8.0	43.0	3.4	4.400
SO CV 43A40-6-1/8	028.3400.100	100	10x1.0	12	12	14	12	54.0	5.0	41.5	3.8	3.240
SO CV 43A40-6-1/4	028.3400.110	100	10x1.0	12	12	14	14	58.5	8.0	43.0	3.8	4.300
SO CV 43A40-6-3/8	028.3400.120	100	10x1.0	12	12	14	17	57.0	8.0	41.5	3.8	5.450
SO CV 43A40-8-1/8	028.3400.160	100	12x1.0	14	14	17	14	61.0	5.0	48.0	5.0	4.600
SO CV 43A40-8-1/4	028.3400.170	100	12x1.0	14	14	17	14	65.0	8.0	49.0	5.8	5.100
SO CV 43A40-8-3/8	028.3400.180	100	12x1.0	14	14	17	17	64.5	8.0	48.5	5.8	6.600
SO CV 43A40-10-1/4	028.3400.270	64	14x1.0	17	19	22	17	73.0	8.0	55.0	7.5	8.150
SO CV 43A40-10-3/8	028.3400.280	64	14x1.0	17	19	22	17	72.5	8.0	54.5	7.5	8.880
* SO CV 43A40-12-3/8	028.3400.390	50	20x1.5	24	24	27	24	82.5	8.0	62.0	10.0	16.450
* SO CV 43A40-12-1/2	028.3400.400	50	20x1.5	24	24	27	24	83.5	10.0	61.0	10.0	17.110
* SO CV 43A40-12-3/4	028.3400.405	50	20x1.5	24	24	27	27	85.0	12.0	60.5	10.0	20.930
SO CV 43A40-14-1/2	028.3400.504	50	20x1.5	24	24	27	24	83.5	10.0	61.0	11.0	16.890
SO CV 43A40-15-1/2	028.3400.534	50	20x1.5	24	24	27	24	83.5	10.0	61.0	11.0	17.290

Montagehinweis: Nippel ist handfest montiert. Bei Endmontage mit 1/4 Umdrehung anziehen.

Wir empfehlen eine zusätzliche Schmierung auf der Planfläche.

Note d'installation: L'adaptateur femelle-mâle est monté serré à la main. Pour le montage final, serrer avec 1/4 de tour.

Nous recommandons une lubrification supplémentaire sur la surface plane.

Assembly information: Male adaptor is mounted finger-tight. For final assembly, tighten with 1/4 turn.

We recommend additional lubrication on the plane surface.

d=Rohrassen- \emptyset
e=kleinste Bohrung
L=Mass in montiertem Zustand
*=mit reduziertem Klemmring

d= \emptyset extérieur du tube
e= \emptyset -min. de passage
L=après montage
*=avec bague de serrage de réduction

d=tube outside diameter
e=minimum bore
L=installed length
*=with reduced compression ferrule

Schwenkverschraubung

mit Drossel-Ventil

Coude banjo

avec limiteur de débit

Single banjo

with throttle valve

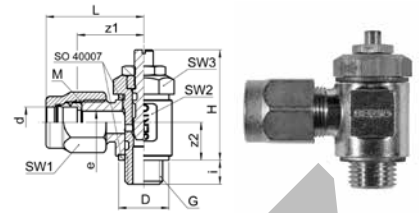
SO 47624

Type -d-G	Mat.-Nr.	bar	M	SW1	SW2	SW3	L	D	H	i	z1	z2	e	kv	kg/100
Für metrische Rohre															
G=Rohrgewinde (zylindrisch)															
* SO 47624-3-1/8	028.7600.040	16	8x1.0	10	14	14	24.0	15.0	26.0	6.5	17.5	10.0	2.5	3.0	4.000
SO 47624-4-1/8	028.7600.060	16	8x1.0	10	14	14	23.5	15.0	26.0	6.5	17.5	10.0	3.4	3.0	3.800
SO 47624-5-1/8	028.7600.082	16	8x1.0	10	14	14	24.0	15.0	26.0	6.5	17.5	10.0	4.0	3.0	3.700
SO 47624-6-1/8	028.7600.100	16	10x1.0	12	14	14	25.0	15.0	26.0	6.5	17.5	10.0	4.0	3.0	4.300
* SO 47624-6-1/4	028.7600.110	16	12x1.0	14	19	19	29.0	20.0	31.5	8.0	21.0	13.5	4.5	6.0	8.600
SO 47624-8-1/8	028.7600.160	16	12x1.0	14	14	14	25.5	15.0	31.5	6.5	17.5	10.0	3.5	3.0	4.600
SO 47624-8-1/4	028.7600.170	16	12x1.0	14	19	19	29.0	20.0	31.5	8.0	21.0	13.5	5.0	6.0	8.400
SO 47624-10-1/4	028.7600.270	16	14x1.0	17	19	19	32.0	20.0	31.5	8.0	21.0	13.5	5.0	6.0	9.000

Für Zollrohre

Pour tubes pouces

For inch tubes

SO 47624-6,35-1/8	028.7600.135	16	10x1.0	12	14	14	25.0	15.0	26.0	6.5	17.5	10.0	3.5	3.0	4.200
SO 47624-9,52-1/4	028.7600.230	16	14x1.0	17	19	19	31.0	20.0	31.5	8.0	21.0	13.5	5.0	6.0	9.100

Umrechnung für "d" bei Zollrohren:

$$6,35 = 1/4$$

$$9,52 = 3/8$$

Conversion de "d" pour tubes en pouces:

$$6,35 = 1/4$$

$$9,52 = 3/8$$

Conversion for "d" for inch tubes:

$$6,35 = 1/4$$

$$9,52 = 3/8$$

Temperatur: -20°C bis +80°C

Température: -20°C à +80°C

Temperature: -20°C to +80°C

Dieses Drossel-Ventil dient zur Regulierung der Ströme von Gas- und Flüssigmedien in beiden Richtungen. Die Spindelfixierung mittels Kontermutter garantiert, dass sich die Spindel auch bei Vibration nicht verstellt.

Einsatz: ideal für Luft, Wasser, Öle

Ce limiteur de débit est utilisé pour réguler le débit des fluides gazeux et liquides dans les deux sens. La fixation de la broche à l'aide d'un contre-écrou garantit que la broche ne se déplace pas, même en cas de vibrations.

Utilisation: idéal pour l'air, l'eau, les huiles

This throttle valve is used to regulate the flow of gas and liquid media in both directions. The spindle fixation by means of a counter-nut assures that spindle does not shift, even in case of vibration.

Use: ideal for air, water oils

Werkstoffe:

Körper, Ventileinsatz, Anschlüsse: Messing

O-Ring: NBR

Matériaux:

Soupape, pointeau, écrous: laiton

Joint torique: NBR

Materials:

Body, components, connections: brass

O-ring: NBR

Sicherheitsfaktor Betriebsdruck (PN): 1.5-fach

Facteur de sécurité pression de service (PN):

1,5 fois

Safety factor working pressure (PN): 1.5 times

d=Rohrassen-ø

e=kleinste Bohrung

kv=Kenngröße für das Durchflussverhalten (l/min)

L=Mass in montiertem Zustand

*=mit reduziertem Klemmring

d=ø extérieur du tube

e=ø-min. de passage

kv=facteur d'écoulement (l/min)

L=après montage

*=avec bague de serrage de réduction

d=tube outside diameter

e=minimum bore

kv=flow factor (l/min)

L=installed length

*=with reduction compression ferrule

Schwenkverschraubung

mit Drossel-Rückschlagventil

Coude banjo

avec clapet anti-retour limiteur de débit

Single banjo

with throttle non-return valve

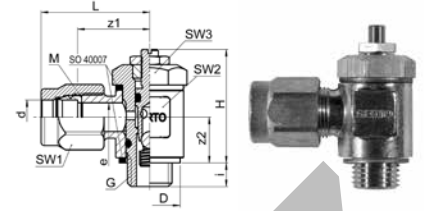
SO 47724

12

Type -d-G	Mat.-Nr.	bar	M	SW1	SW2	SW3	L	D	H	i	z1	z2	e	kv	kg/100
Für metrische Rohre															
G=Rohrgewinde (zylindrisch)															
* SO 47724-3-1/8	028.7700.040	16	8x1.0	10	14	14	24.0	15.0	26.0	6.5	17.5	10.0	2.5	3.0	4.000
SO 47724-4-1/8	028.7700.060	16	8x1.0	10	14	14	23.5	15.0	26.0	6.5	17.5	10.0	3.4	3.0	3.800
SO 47724-5-1/8	028.7700.082	16	8x1.0	10	14	14	24.0	15.0	26.0	6.5	17.5	10.0	3.5	3.0	3.700
SO 47724-6-1/8	028.7700.100	16	10x1.0	12	14	14	25.0	15.0	26.0	6.5	17.5	10.0	3.5	3.0	4.300
* SO 47724-6-1/4	028.7700.110	16	12x1.0	14	19	19	29.0	20.0	31.5	8.0	21.0	13.5	4.5	6.0	8.600
SO 47724-8-1/8	028.7700.160	16	12x1.0	14	14	14	25.5	15.0	26.0	6.5	17.5	10.0	3.5	3.0	4.600
SO 47724-8-1/4	028.7700.170	16	12x1.0	14	19	19	29.0	20.0	31.5	8.0	21.0	13.5	5.0	6.0	8.400
SO 47724-10-1/4	028.7700.270	16	14x1.0	17	19	19	32.0	20.0	33.5	8.0	21.0	13.5	5.0	6.0	9.700

Für Zollrohre															
SO 47724-6,35-1/8	028.7700.135	16	10x1.0	12	14	14	25.0	15.0	26.0	6.5	17.5	10.0	3.5	3.0	4.200
SO 47724-9,52-1/4	028.7700.230	16	14x1.0	17	19	19	31.0	20.0	31.5	8.0	21.0	13.5	5.0	6.0	9.100

Umrechnung für "d" bei Zollrohren:
 6,35 = 1/4
 9,52 = 3/8

Conversion de "d" pour tubes en pouces:
 6,35 = 1/4
 9,52 = 3/8

Conversion for "d" for inch tubes:
 6,35 = 1/4
 9,52 = 3/8

Temperatur: -20°C bis +80°C

Température: -20°C à +80°C

Temperatur: -20°C to +80°C

Dieses Drossel-Rückschlagventil dient zur Regulierung von Gas- und Flüssigmedien in eine Richtung und verhindert einen entgegengesetzten Medienfluss. Die Spindelfixierung mittels Kontermutter garantiert, dass sich die Spindel auch bei Vibration nicht verstellt. Einsatz: ideal für Luft, Wasser, Öle

Ce clapet anti-retour limiteur de débit est utilisé pour réguler les fluides gazeux et liquides dans un sens et empêchent l'écoulement du fluide dans le sens opposé. La fixation de la broche à l'aide d'un contre-écrou garantit que la broche ne se déplace pas, même en cas de vibrations. Utilisation: idéal pour l'air, l'eau, les huiles

This throttle non-return valve is used to regulate gas and liquid media in one direction and prevents media flow in the opposite direction. The spindle fixation by means of a counter-nut ensures that spindle does not shift, even in case of vibration. Use: ideal for air, water oils

Werkstoffe:

Körper, Ventileinsatz, Anschlüsse: Messing
 O-Ring: NBR
 Feder: Edelstahl 1.4310
 Kugel: Polyurethan

Matériaux:

Clapet, pointeau, écrous: laiton
 Joint torique: NBR
 Ressort: acier inoxydable 1.4310
 Bille: polyuréthane

Materials:

Body, components, connections: brass
 O-ring: NBR
 Spring: stainless steel 1.4310
 Ball: polyurethane

Sicherheitsfaktor Betriebsdruck (PN): 1.5-fach

Facteur de sécurité pression de service (PN): 1.5 fois

Safety factor working pressure (PN): 1.5 times

d=Rohrassens-ø
 e=kleinste Bohrung
 kv=Kenngröße für das Durchflussverhalten (l/min)
 L=Mass in montiertem Zustand
 *=mit reduziertem Klemmring

d=ø extérieur du tube
 e=ø-min. de passage
 kv=facteur d'écoulement (l/min)
 L=après montage
 *=avec bague de serrage de réduction

d=tube outside diameter
 e=minimum bore
 kv=flow factor (l/min)
 L=installed length
 *=with reduction compression ferrule

Mini-Kugelhahn

mit Innengewinde

Mini vanne à bille

avec taraudage

Mini-ball valve

with female thread

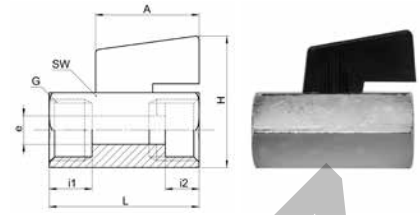

SO BV 48A00

Type -G	Mat.-Nr.	bar	SW	L	A	H	i1	i2	e	kv	kg/100
G=Rohrgewinde (zylindrisch)	G=Filetage-gaz BSP (cylindrique)	G=BSP thread (parallel)									
SO BV 48A00-1/8	TKH.478.5011	10	20	39.0	30.0	37.5	9.0	10.0	8.0	45.0	9.900
SO BV 48A00-1/4	TKH.478.5012	10	20	39.0	30.0	37.5	9.0	10.2	8.0	67.0	9.500
SO BV 48A00-3/8	TKH.478.5013	10	20	42.0	30.0	37.5	12.0	10.0	8.0	67.0	8.700
SO BV 48A00-1/2	TKH.478.5014	10	24	47.0	30.0	41.5	12.0	11.5	10.0	90.0	13.200
SO BV 48A00-3/4	TKH.478.5015	10	30	54.0	30.0	46.5	14.5	12.0	13.5	130.0	19.300

Spezifikationen

Betriebsdruck (PN): 10 bar
 Temperatur: -10°C bis +90°C
 Sicherheitsfaktor: 1.5-fach
 Breite Anwendungsvielfalt: Ideal für Wasser, Luft, Mineralöl, für Sanitär, Heizung, Apparatebau.

Materialien

Körper: Messing CW 617N verchromt
 Kugeldichtung: PTFE
 Spindeldichtung: NBR

Dienstleistungsoptionen auf Anfrage

Spécifications

Pression de service (PN): 10 bar
 Température: -10°C à +90°C
 Facteur de sécurité: 1.5 fois
 Champ d'application étendu: Idéal pour l'eau, l'air, l'huile minérale, pour l'industrie sanitaire, le chauffage et la construction des appareils.

Matériaux

Corps: laiton CW 617N chromé
 Joint du bille: PTFE
 Joint du tige: NBR

Options de service sur demande

Specifications

Working pressure (PN): 10 bar
 Temperature: -10°C to +90°C
 Safety factor: 1.5 times
 Large field of application: Ideal for water, air, mineral oil, for sanitary purposes, heating industry and the construction of apparatus.

Materials

Body: brass CW 617N chrome-plated
 Ball gasket: PTFE
 Spindle O-ring: NBR

Optional services on request

Mini-Kugelhahn

mit Innen-/Aussengewinde

Mini vanne à bille

avec taraudage/filetage

Mini-ball valve

with female/male thread

SO BV 48A05

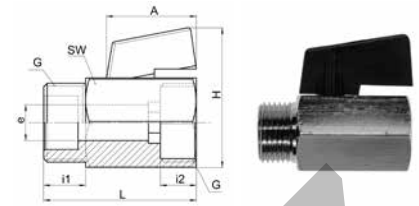

Type -G	Mat.-Nr.	bar	SW	L	A	H	i1	i2	e	kv	kg/100
G=Rohrgewinde (zylindrisch)	G=Filetage-gaz BSP (cylindrique)	G=BSP thread (parallel)									
SO BV 48A05-1/8	TKH.478.5111	10	20	39.0	30.0	37.5	9.0	10.0	8.0	45.0	8.400
SO BV 48A05-1/4	TKH.478.5112	10	20	39.0	30.0	37.5	9.0	10.0	8.0	67.0	8.100
SO BV 48A05-3/8	TKH.478.5113	10	20	40.0	30.0	37.5	10.0	10.0	8.0	67.0	7.800
SO BV 48A05-1/2	TKH.478.5114	10	24	45.0	30.0	41.5	12.2	11.5	10.0	90.0	12.000
SO BV 48A05-3/4	TKH.478.5115	10	30	51.0	30.0	46.5	14.0	12.0	13.5	130.0	17.800

Spezifikationen

Betriebsdruck (PN): 10 bar

Temperatur: -10°C bis +90°C

Sicherheitsfaktor: 1.5-fach

Breite Anwendungsvielfalt: Ideal für Wasser, Luft, Mineralöl, für Sanitär, Heizung, Apparatebau.

Materialien

Körper: Messing CW 617N verchromt

Kugeldichtung: PTFE

Spindeldichtung: NBR

Dienstleistungsoptionen auf Anfrage

Spécifications

Pression de service (PN): 10 bar

Température: -10°C à +90°C

Facteur de sécurité: 1.5 fois

Champ d'application étendu: Idéal pour l'eau, l'air, l'huile minérale, pour l'industrie sanitaire, le chauffage et la construction des appareils.

Matériaux

Corps: laiton CW 617N chromé

Joint du bille: PTFE

Joint du tige: NBR

Options de service sur demande

Specifications

Working pressure (PN): 10 bar

Temperature: -10°C to +90°C

Safety factor: 1.5 times

Large field of application: Ideal for water, air, mineral oil, for sanitary purposes, heating industry and the construction of apparatus.

Materials

Body: brass CW 617N chrome-plated

Ball gasket: PTFE

Spindle O-ring: NBR

Optional services on request

Mini-Kugelhahn

mit Aussengewinde

Mini vanne à bille

avec filetage

Mini-ball valve

with male thread

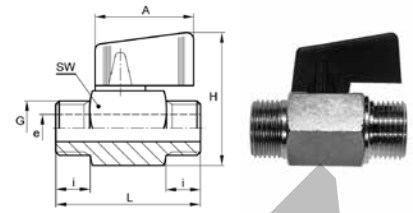

SO BV 48A10

Type -G	Mat.-Nr.	bar	SW	L	A	H	i	e	kv	kg/100
G=Rohrgewinde (zylindrisch)	G=Filetage-gaz BSP (cylindrique)	G=BSP thread (parallel)								
SO BV 48A10-1/4	TKH.478.5212	10	20	40.5	30.0	37.5	9.0	8.0	67.0	8.100
SO BV 48A10-3/8	TKH.478.5213	10	20	42.5	30.0	37.5	10.0	8.0	67.0	7.800
SO BV 48A10-1/2	TKH.478.5214	10	24	50.0	30.0	41.5	11.5	10.0	90.0	12.000

Spezifikationen

Betriebsdruck (PN): 10 bar

Temperatur: -10°C bis +90°C

Sicherheitsfaktor: 1.5-fach

Breite Anwendungsvielfalt: Ideal für Wasser, Luft, Mineralöl, für Sanitär, Heizung, Apparatebau.

Materialien

Körper: Messing CW 617N verchromt

Kugeldichtung: PTFE

Spindeldichtung: NBR

Dienstleistungsoptionen auf Anfrage

Spécifications

Pression de service (PN): 10 bar

Température: -10°C à +90°C

Facteur de sécurité: 1.5 fois

Champ d'application étendu: Idéal pour l'eau, l'air, l'huile minérale, pour l'industrie sanitaire, le chauffage et la construction des appareils.

Matériaux

Corps: laiton CW 617N chromé

Joint du bille: PTFE

Joint du tige: NBR

Options de service sur demande

Specifications

Working pressure (PN): 10 bar

Temperature: -10°C to +90°C

Safety factor: 1.5 times

Large field of application: Ideal for water, air, mineral oil, for sanitary purposes, heating industry and the construction of apparatus.

Materials

Body: brass CW 617N chrome-plated

Ball gasket: PTFE

Spindle O-ring: NBR

Optional services on request

Regulier- / Feinregulierventil
Vanne de réglage / réglage fin
Regulating / fine regulating valve

SO NV 01A21
SO NV 01C21

12

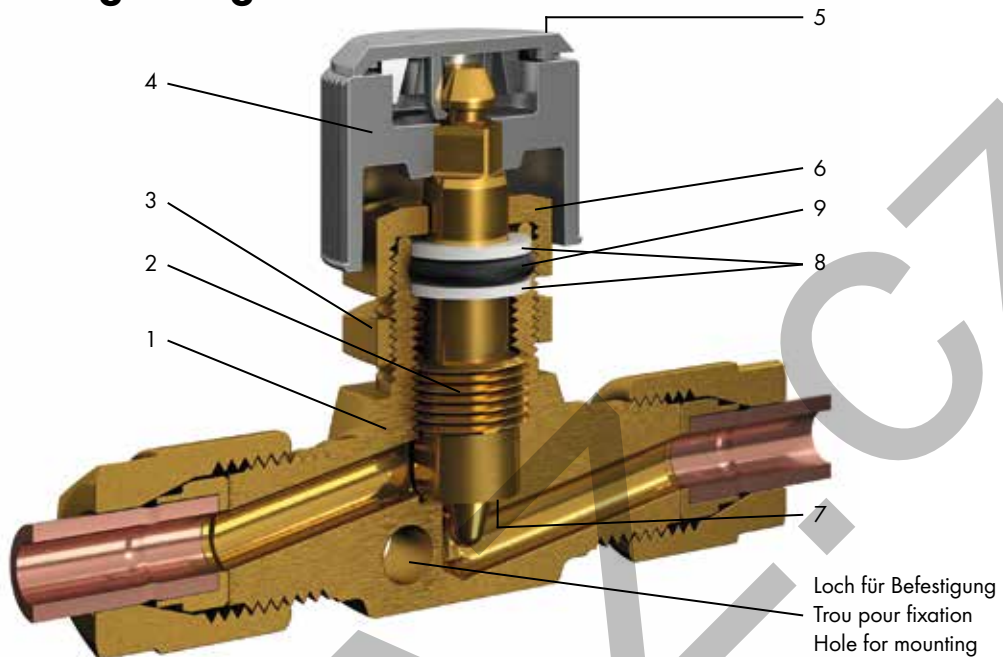

Nr. No. No.	Bezeichnung Désignation Description	Material Matériau Material	Nr. No. No.	Bezeichnung Désignation Description	Material Matériau Material	Nr. No. No.	Bezeichnung Désignation Description	Material Matériau Material
1	Ventilkörper Corps de vanne Valve body	Messing Laiton Brass	4	Handrad (grau) Volant (gris) Handwheel (grey)	Polyamid Polyamide Polyamide	7*	Spindeldichtung Joint du pointeau Spindle seal	NBR/ PTFE ¹⁾
2	Ventilspindel Pointeau de vanne Valve spindle	Messing Laiton Brass	5*	Ventilschild (grau) Plaque indicatrice (gris) Valve label (grey)	Polyamid Polyamide Polyamide	8	Dichtscheibe Rondelle de joint Sealing washer	PVDF
3	Kontermutter Contre-écrou Counter nut	Messing Laiton Brass	6*	Ventilkappe Bouchon presse-étoupe Valve cap	Messing Laiton Brass	9	Dichtung Joint Seal	NBR

Spezifikationen

Betriebsdruck (PN): 50 bar
 Temperatur: -20°C bis +80°C
 Sicherheitsfaktor: 1.5-fach

Merkmale

- Funktion: Regulier- und Absperrventil
- Einsatz: Luft, Wasser, Öle und Flüssiggase (Beständigkeit Dichtung beachten)
- Material: Messing CW617N (CuZn40Pb2)
- Besonderes: kompakte Abmessungen, hohe Zuverlässigkeit

¹⁾ Regulierventil = NBR
 Feinregulierventil = PTFE

*** Optionen**

- Nr. 5 - Ventilschild wahlweise auch in den Farben blau, rot, grün, siehe VSD SO NV
- Nr. 6 - Drehmoment für Ventilkappe bei Schalttafelmontage = 3.4 Nm
- Nr. 7 - nur Regulierventil: EPDM, FKM
- Nr. 9 - Regulier-/Feinregulierventil: EPDM, FKM

Spécifications

Pression de service (PN): 50 bar
 Température: -20°C à +80°C
 Facteur de sécurité: 1.5 fois

Caractéristiques

- Fonction: vanne de régulation et de retenue
- Application: air, eau, huiles et gaz liquéfiés (tenir compte de la résistance de l'étanchéité)
- Matériau: laiton CW617N (CuZn40Pb2)
- Particularités: dimensions compactes, grande fiabilité

¹⁾ Vanne de réglage = NBR
 Vanne de réglage fin = PTFE

*** Options**

- No. 5 - Plaques au choix disponible en couleurs bleu, rouge, vert, voir VSD SO NV
- No. 6 - Couple de serrage pour bouchon de vanne dans tableau de commande = 3.4 Nm
- No. 7 - Vanne de réglage: EPDM, FKM
- No. 9 - Vanne de réglage/régulation fin: EPDM, FKM

Specifications

Working pressure (PN): 50 bar
 Temperature: -20°C to +80°C
 Safety factor: 1.5 times

Characteristics

- Function: regulating and stop valve
- Uses: air, water, oils and liquid gases (check resistance of seal)
- Material: brass CW617N (CuZn40Pb2)
- Special: compact dimensions, high reliability

¹⁾ Regulating valve = NBR
 Fine regulating valve = PTFE

*** Options**

- No. 5 - Valve labels also available in colors blue, red, green, see VSD SO NV
- No. 6 - Torque for valve cap in panel mounting = 3.4 Nm
- No. 7 - Regulating valve only: EPDM, FKM
- No. 9 - Regulating/fine regulating valve: EPDM, FKM

Durchflussdiagramm

Courbe de débit

Flow rate

Reguliertventile / Vannes de réglage /
Regulating valves

Feinreguliertventile / Vannes de réglage fin /
Fine regulating valves

SO NV 01A21

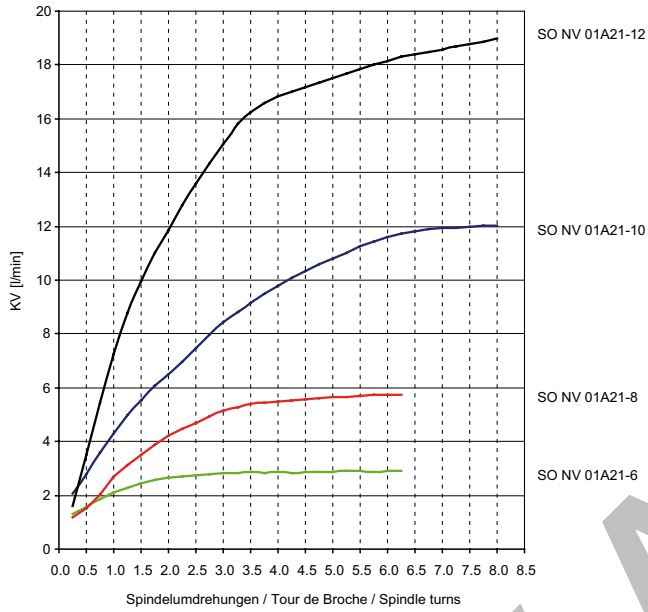

SO NV 01C21

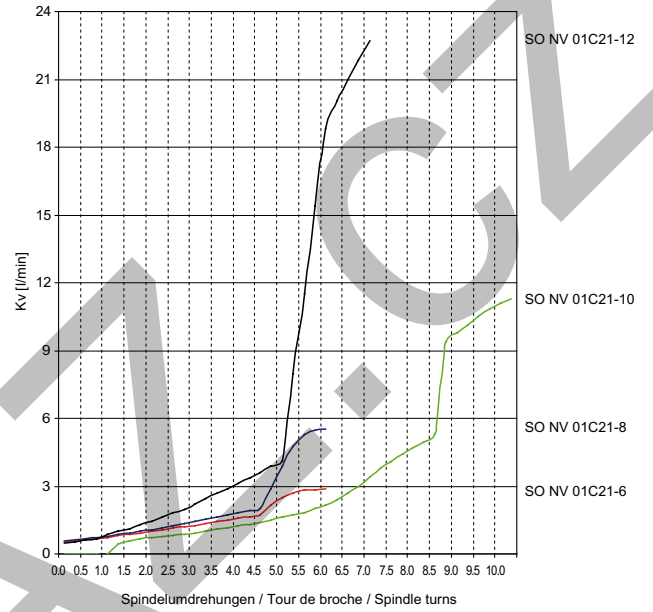

Sonderausführungen

siehe Kapitelübersicht

Exécutions en option

voir aperçu du chapitre

Optional services

see chapter overview

Zubehör

Anschraubfuss für Wandmontage siehe
SO 09900

Accessoires

Support de fixation voir SO 09900

Accessoires

Flange mount for wall fastening see SO 09900

Reguliertventil
Vanne de réglage
Regulating valve

12

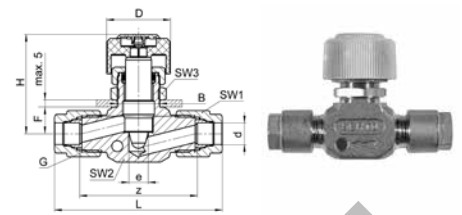

SO NV 01A21

Type -d	Mat.-Nr.	bar	G	SW1	SW2	SW3	L	D	H	B	F	z	e	kv	kg/100
SO NV 01A21-4	258.7100.040	50	1/8	12	14	19	64.0	26.0	47.0	16.5	10.0	50.5	3.5	3.0	12.200
SO NV 01A21-5	258.7100.050	50	1/8	12	14	19	66.0	26.0	47.0	16.5	10.0	50.5	4.0	3.0	12.200
SO NV 01A21-6	258.7100.060	50	1/8	12	14	19	66.0	26.0	47.0	16.5	10.0	50.5	4.0	3.0	12.000
SO NV 01A21-8	258.7100.080	50	1/4	14	14	19	70.5	26.0	47.0	16.5	10.0	51.0	5.0	5.5	15.000
SO NV 01A21-10	258.7100.100	50	3/8	17	18	24	84.0	36.0	54.5	20.5	14.0	60.0	6.5	12.5	26.000
SO NV 01A21-12	258.7100.120	50	1/2	19	22	27	95.0	36.0	66.0	24.5	15.0	66.5	9.5	19.0	33.500
SO NV 01A21-14	258.7100.140	50	1/2	22	22	27	99.0	36.0	66.0	24.5	15.0	67.0	9.5	19.0	34.600
SO NV 01A21-15	258.7100.150	50	1/2	22	22	27	99.0	36.0	66.0	24.5	15.0	67.0	9.5	19.0	34.800

KONVARIANT

d=Rohrassen-ø
 e=kleinste Bohrung
 kv=Kenngröße für das Durchflussverhalten (l/min)
 L=Mass in montiertem Zustand
 H=Ventil geöffnet

d=ø extérieur du tube
 e=ø-min. de passage
 kv=facteur d'écoulement (l/min)
 L=après montage
 H=vanne ouvert

d=tube outside diameter
 e=minimum bore
 kv=flow factor (l/min)
 L=installed length
 H=valve open

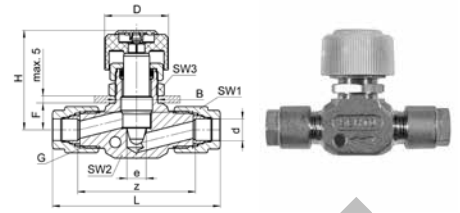
Feinreguliertventil
Vanne de réglage fin
Fine regulating valve

SO NV 01C21

Type -d	Mat.-Nr.	bar	G	SW1	SW2	SW3	L	D	H	B	F	z	e	kv	kg/100
SO NV 01C21-4	258.7200.040	50	1/8	12	14	19	64.0	26.0	47.0	16.5	10.0	50.5	3.5	3.0	12.000
SO NV 01C21-5	258.7200.050	50	1/8	12	14	19	66.0	26.0	47.0	16.5	10.0	50.5	4.0	3.0	12.000
SO NV 01C21-6	258.7200.060	50	1/8	12	14	19	66.0	26.0	47.0	16.5	10.0	50.5	4.0	3.0	11.800
SO NV 01C21-8	258.7200.080	50	1/4	14	14	19	70.0	26.0	47.0	16.5	10.0	51.0	5.0	5.5	14.500
SO NV 01C21-10	258.7200.100	50	3/8	17	18	24	84.0	36.0	54.5	20.5	14.0	60.0	6.5	11.5	25.800
SO NV 01C21-12	258.7200.120	50	1/2	19	22	27	95.0	36.0	66.0	24.5	15.0	66.5	9.5	23.0	33.000
SO NV 01C21-14	258.7200.140	50	1/2	22	22	27	99.0	36.0	66.0	24.5	15.0	67.0	9.5	23.0	34.400
SO NV 01C21-15	258.7200.150	50	1/2	22	22	27	99.0	36.0	66.0	24.5	15.0	67.0	9.5	23.0	34.600

d=Rohrassen-ø
 e=kleinste Bohrung
 kv=Kenngröße für das Durchflussverhalten (l/min)
 L=Mass in montiertem Zustand
 H=Ventil geöffnet

d=ø extérieur du tube
 e=ø-min. de passage
 kv=facteur d'écoulement (l/min)
 L=après montage
 H=vanne ouvert

d=tube outside diameter
 e=minimum bore
 kv=flow factor (l/min)
 L=installed length
 H=valve open

Regulier- / Feinregulier- / Dosiereckventil
Vanne-équerre de réglage / réglage fin / précision
Elbow regulating / fine regulating / metering valve

**SO NV 01A21E/
EL/ET**
SO NV 01C21E
SO NV 01D21E/ET

12

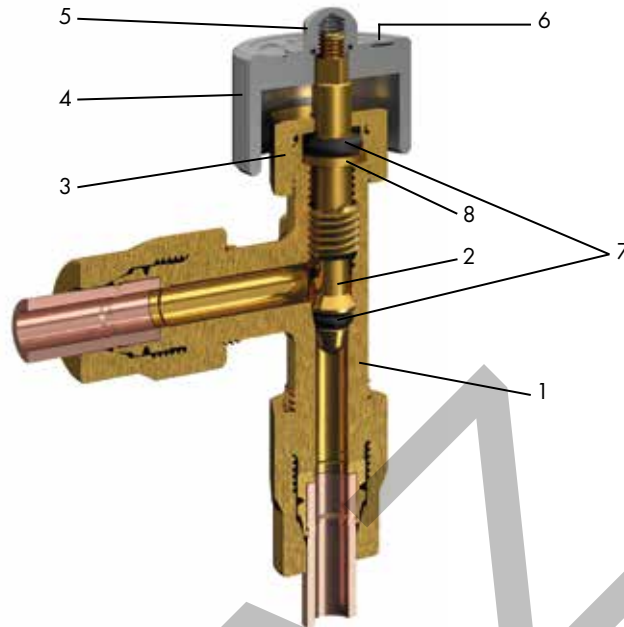

Nr. No. No.	Bezeichnung Désignation Description	Material Matériau Material	Nr. No. No.	Bezeichnung Désignation Description	Material Matériau Material	Nr. No. No.	Bezeichnung Désignation Description	Material Matériau Material
1	Ventilkörper Corps de vanne Valve body	Messing Laiton Brass	4	Handrad (grau) Volant (gris) Handwheel (grey)	Aluminium	7*	Dichtung Joint Seal	NBR
2	Ventilspindel Pointeau de vanne Valve spindle	Messing Laiton Brass	5	Hutmutter Écrou borgne Cap nut	Mess. CV Laiton CV Brass CV	8	Unterlagsscheibe Rondelle Washer	Messing Laiton Brass
3	Ventilkappe Bouchon presse-étoupe Valve cap	Messing Laiton Brass	6*	Ventilschild (schwarz) Plaque indicatrice (noir) Valve label (black)	Aluminium			

Spezifikationen

Betriebsdruck (PN): 50 bar
 Temperatur: -20°C bis +80°C
 Sicherheitsfaktor: 1.5-fach

Merkmale

- Funktion:
Regulier- und Absperrventil (SO NV 01Axx)
Feinregulierventil (SO NV 01Cxx)
Dosierventil (SO NV 01Dxx)
- Einsatz: Luft, Wasser, Öle und Flüssiggase
(Beständigkeit Dichtung beachten)
- Material: Messing CW617N (CuZn40Pb2)

* Optionen

- Nr. 6 - Ventilschild wahlweise auch in den Farben blau, rot, grün, gelb, siehe VSD SO NV
- Nr. 7 - Dichtung: EPDM, FKM

Spécifications

Pression de service (PN): 50 bar
 Température: -20°C à +80°C
 Facteur de sécurité: 1.5 fois

Caractéristiques

- Fonction:
Vanne de régulation et de retenue (SO NV 01Axx)
Vanne de réglage fin (SO NV 01Cxx)
Vanne de précision (SO NV 01Dxx)
- Application: air, eau, huiles et gaz liquéfiés
(tenir compte de la résistance de l'étanchéité)
- Matériau: laiton CW617N (CuZn40Pb2)

* Options

- No. 6 - Plaques signalétiques au choix disponible en couleurs bleu, rouge, vert, jaune, voir VSD SO NV
- No. 7 - Joint: EPDM, FKM

Specifications

Working pressure (PN): 50 bar
 Temperature: -20°C to +80°C
 Safety factor: 1.5 times

Characteristics

- Function:
Regulating and stop valve (SO NV 01Axx)
Fine regulating valve (SO NV 01Cxx)
Dosing valve (SO NV 01Dxx)
- Uses: air, water, oils and liquid gases (check resistance of seal)
- Material: brass CW617N (CuZn40Pb2)

* Options

- No. 6 - Valve labels also available in colors blue, red, green, yellow, see VSD SO NV
- No. 7 - Seal: EPDM, FKM

Durchflussdiagramm

Courbe de débit

Flow rate

**SO NV 01A21E / SO NV 01A21EL / SO NV 01A21ET /
SO NV 01C21E / SO NV 01D21E / SO NV 01D21ET**

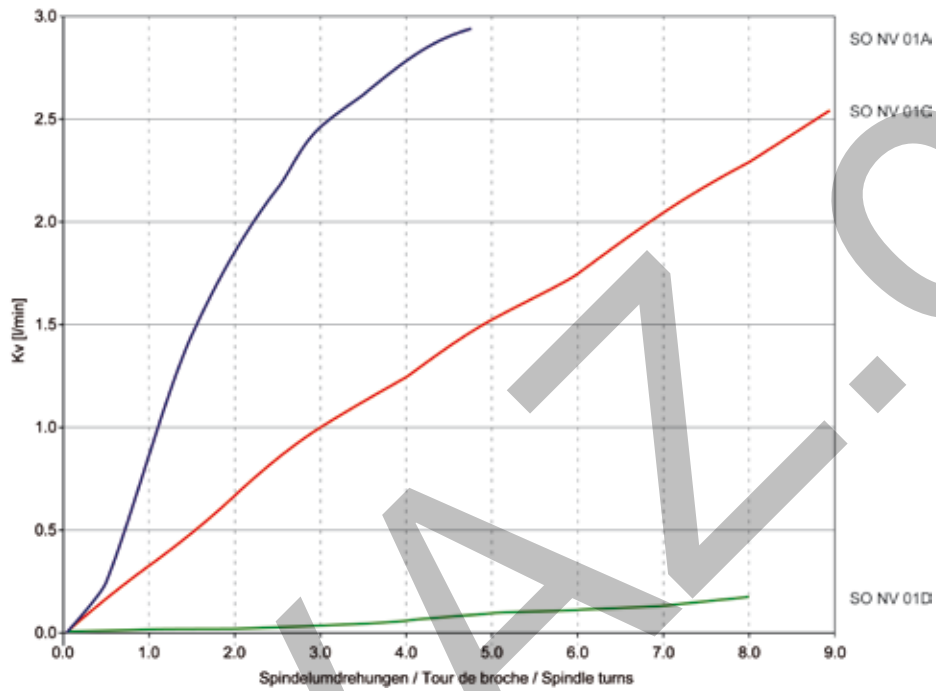

Sonderausführungen

siehe Kapitelübersicht

Exécutions en option

voir aperçu du chapitre

Optional services

see chapter overview

Regulier-Eckventil
Vanne-équerre de réglage
Elbow regulating valve

12

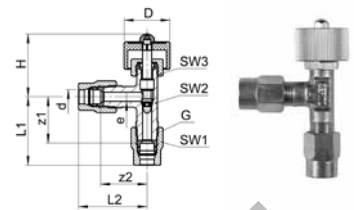

SO NV 01A21E

Type -d	Mat.-Nr.	bar	G	SW1	SW2	SW3	L1	L2	D	H	z1	z2	e	kv	kg/100
SO NV 01A21E-4	258.7420.040	50	1/8	12	10	12	27.0	27.0	20.0	32.0	20.0	20.0	3.5	3.0	5.000
SO NV 01A21E-5	258.7420.050	50	1/8	12	10	12	27.0	27.0	20.0	32.0	20.0	20.0	4.0	3.0	6.000
SO NV 01A21E-6	258.7420.060	50	1/8	12	10	12	28.0	27.0	20.0	32.0	20.0	20.0	4.0	3.0	6.000

KROVAVANZ

d=Rohraussen-ø
 e=kleinste Bohrung
 kv=Kenngröße für das Durchflussverhalten (l/min)
 L=Mass in montiertem Zustand
 H=Ventil geöffnet

d=ø extérieur du tube
 e=ø-min. de passage
 kv=facteur d'écoulement (l/min)
 L=après montage
 H=vanne ouvert

d=tube outside diameter
 e=minimum bore
 kv=flow factor (l/min)
 L=installed length
 H=valve open

Regulier-Eckventil

mit Einstellzapfen

Vanne-équerre de réglage

orientable

Elbow regulating valve

adjustable

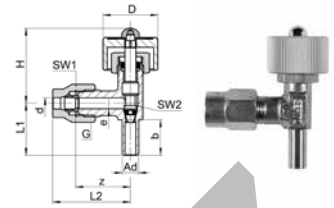

SO NV 01A21EL

Type -d -Ad	Mat.-Nr.	bar	G	SW1	SW2	L1	L2	D	H	b	z	e	kv	kg/100
SO NV 01A21EL-4-A6	YDD.060.0021	50	1/8	12	10	19.0	27.0	20.0	32.0	13.0	20.0	3.5	3.0	5.000
SO NV 01A21EL-5-A6	YDD.060.0022	50	1/8	12	10	19.0	27.0	20.0	32.0	13.0	20.0	4.0	3.0	5.000
SO NV 01A21EL-6-A6	YDD.060.0023	50	1/8	12	10	19.0	28.0	20.0	32.0	13.0	20.0	4.0	3.0	5.000

Regulier-Eckventil

Schalttafel ausführung

Vanne-équerre de réglage

pour tableau de commande

Elbow regulating valve

for panel mounting

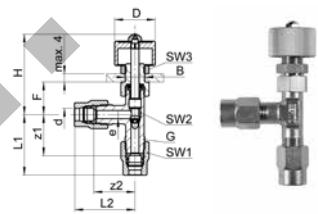

SO NV 01A21ET

Type -d	Mat.-Nr.	bar	G	SW1	SW2	SW3	L1	L2	H	F	z1	z2	e	kv	kg/100
SO NV 01A21ET-4	YDD.060.0100	50	1/8	12	10	12	27.0	27.0	44.0	18.0	20.0	20.0	3.5	3.0	7.000
SO NV 01A21ET-5	YDD.060.0101	50	1/8	12	10	12	28.0	27.0	45.0	18.0	20.0	20.0	4.0	3.0	7.000
SO NV 01A21ET-6	YDD.060.0102	50	1/8	12	10	12	28.0	28.0	46.0	16.0	20.0	20.0	4.0	3.0	7.000

D = ø 20 mm
B = ø 10 mm

D = ø 20 mm
B = ø 10 mm

D = ø 20 mm
B = ø 10 mm

d=Rohrassen-ø
e=kleinste Bohrung
kv=Kenngröße für das Durchflussverhalten (l/min)
L=Mass in montiertem Zustand
H=Ventil geöffnet

d=ø extérieur du tube
e=ø-min. de passage
kv=facteur d'écoulement (l/min)
L=après montage
H=vanne ouvert

d=tube outside diameter
e=minimum bore
kv=flow factor (l/min)
L=installed length
H=valve open

Feinregulier-Eckventil
Vanne-équerre de réglage fin
Elbow fine regulating valve

12

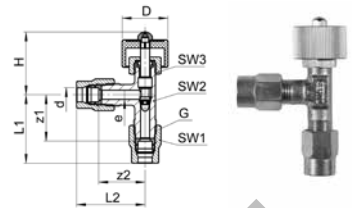
SO NV 01C21E

Type-d	Mat.-Nr.	bar	G	SW1	SW2	SW3	L1	L2	D	H	z1	z2	e	kv	kg/100
SO NV 01C21E-4	YDD.060.0200	50	1/8	12	10	12	27.0	27.0	20.0	32.0	20.0	20.0	2.5	2.5	6.000
SO NV 01C21E-5	YDD.060.0201	50	1/8	12	10	12	27.0	28.0	20.0	32.0	20.0	20.0	2.5	2.5	6.000
SO NV 01C21E-6	YDD.060.0202	50	1/8	12	10	12	28.0	28.0	20.0	32.0	20.0	20.0	2.5	2.5	6.000

Dosier-Eckventil

mit Feinregulierspindel 1:50

Vanne-équerre de réglage de précision

à aiguille 1:50

Metering elbow valve

with fine-regulating spindle 1:50

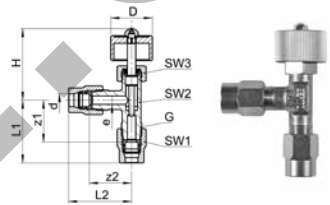
SO NV 01D21E

Type-d	Mat.-Nr.	bar	G	SW1	SW2	SW3	L1	L2	D	H	z1	z2	e	kv	kg/100
SO NV 01D21E-4	YDD.060.0250	50	1/8	12	10	12	27.0	27.0	20.0	32.0	20.0	20.0	2.5	0.1	6.000
SO NV 01D21E-5	YDD.060.0251	50	1/8	12	10	12	27.0	27.0	20.0	32.0	20.0	20.0	2.5	0.1	6.000
SO NV 01D21E-6	YDD.060.0252	50	1/8	12	10	12	28.0	28.0	20.0	32.0	20.0	20.0	2.5	0.1	6.000

Dosier-Eckventil

mit Feinregulierspindel 1:50, Schottausführung

Vanne-équerre de réglage de précision

à aiguille 1:50, traversée de cloison

Metering elbow valve

with fine-regulating spindle 1:50, panel mount

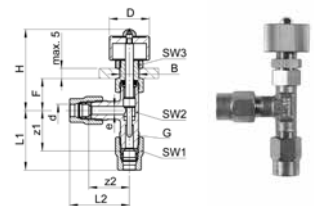
SO NV 01D21ET

Type-d	Mat.-Nr.	bar	G	SW1	SW2	SW3	L1	L2	H	F	z1	z2	e	kv	kg/100
SO NV 01D21ET-4	YDD.060.0350	50	1/8	12	10	12	27.0	27.0	40.0	18.5	20.0	20.0	2.5	0.1	7.000
SO NV 01D21ET-5	YDD.060.0351	50	1/8	12	10	12	27.0	27.0	40.0	18.5	20.0	20.0	2.5	0.1	7.000
SO NV 01D21ET-6	YDD.060.0352	50	1/8	12	10	12	28.0	28.0	40.0	16.0	20.0	20.0	2.5	0.1	7.000

 D = ø 20 mm
 B = ø 10 mm

 D = ø 20 mm
 B = ø 10 mm

 D = ø 20 mm
 B = ø 10 mm

d=Rohrassen-ø
 e=kleinste Bohrung
 kv=Kenngröße für das Durchflussverhalten (l/min)
 L=Mass in montiertem Zustand
 H=Ventil geöffnet

d=ø extérieur du tube
 e=ø-min. de passage
 kv=facteur d'écoulement (l/min)
 L=après montage
 H=vanne ouvert

d=tube outside diameter
 e=minimum bore
 kv=flow factor (l/min)
 L=installed length
 H=valve open

Kegelrückschlagventil
Clapet anti-retour à siège conique
Taper seat non-return valve

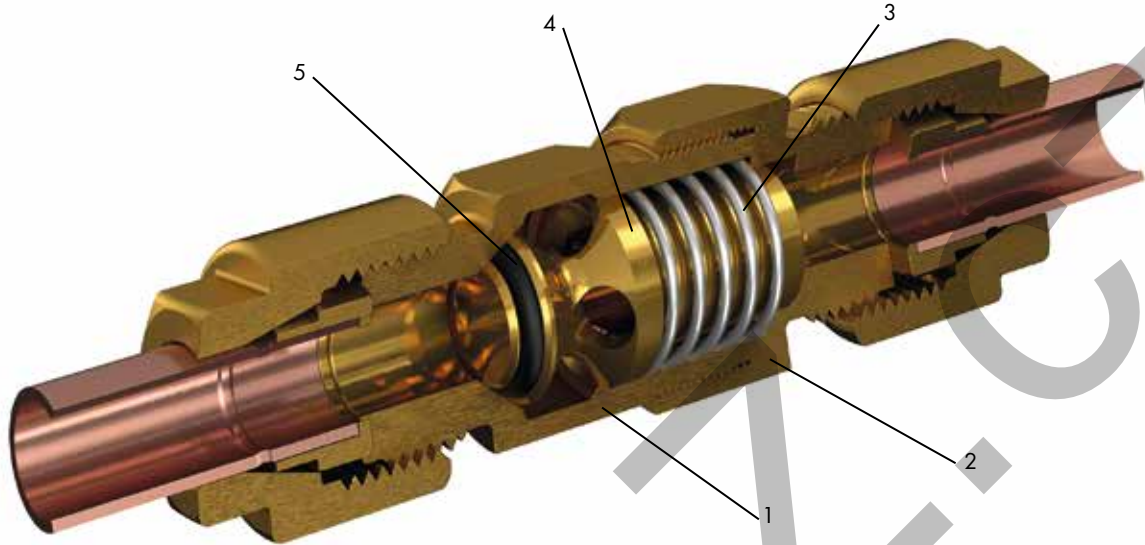
SO CV 03A21

Nr. No. No.	Bezeichnung Désignation Description	Material Matériau Material	Nr. No. No.	Bezeichnung Désignation Description	Material Matériau Material	Nr. No. No.	Bezeichnung Désignation Description	Material Matériau Material
1	Ventilkegelführung Guidage cône du clapet Valve cone guide	Messing Laiton Brass	3*	Druckfeder Ressort de compression Compression spring	1.4401	5*	Dichtung Joint Seal	NBR
2	Ventilmutter Écrou du clapet Valve nut	Messing Laiton Brass	4	Ventilkegel Cône du clapet Valve cone	Messing Laiton Brass			

Spezifikationen

Betriebsdruck (PN): 50 bis 100 bar
 Temperatur: -20°C bis +80°C
 Öffnungsdruck: 0.2 bar ± 0.1 bar
 Sicherheitsfaktor: 1.5-fach

Merkmale

- Funktion: Rückflussverhinderer
- Einsatz: Luft, Wasser, Öle und Flüssiggase (Beständigkeit Dichtung beachten)
- Material: Messing CW617N (CuZn40Pb2)
- Besonderes: strömungsgünstige Konstruktion, Druckstöße werden gedämpft

*** Optionen**

- Nr. 3 - Druckfeder: Öffnungsdruck 0.5, 1, 2, 3, 5 bar ± 20 %
- Nr. 5 - Dichtung: EPDM, FKM

Spécifications

Pression de service (PN): 50 à 100 bar
 Température: -20°C à +80°C
 Pression d'ouverture: 0.2 bar ± 0.1 bar
 Facteur de sécurité: 1.5 fois

Caractéristiques

- Fonction: clapet anti-retour
- Application: air, eau, huiles et gaz liquéfiés (tenir compte de la résistance de l'étanchéité)
- Matériau: laiton CW617N (CuZn40Pb2)
- Particularités: conception favorisant l'écoulement, amortit les coups de bélier

*** Options**

- No. 3 - Ressort de compression: pression d'ouverture 0.5, 1, 2, 3, 5 bar ± 20 %
- No. 5 - Joint: EPDM, FKM

Specifications

Working pressure (PN): 50 to 100 bar
 Temperature: -20°C to +80°C
 Opening pressure: 0.2 bar ± 0.1 bar
 Safety factor: 1.5 times

Characteristics

- Function: check valve
- Uses: air, water, oils and liquid gases (check resistance of seal)
- Material: brass CW617N (CuZn40Pb2)
- Special: flow-optimised design, damps water hammer

*** Options**

- No. 3 - Compression spring: opening pressure 0.5, 1, 2, 3, 5 bar ± 20 %
- No. 5 - Seal: EPDM, FKM

Durchflussdiagramm

Der Druckabfall nimmt mit zunehmendem Durchfluss überproportional zu.

Courbe de débit

La perte de pression augmente disproportionnellement avec plus de débit.

Flow rate

The pressure drop increases disproportionately with increasing flow rate.

SO CV 03A21

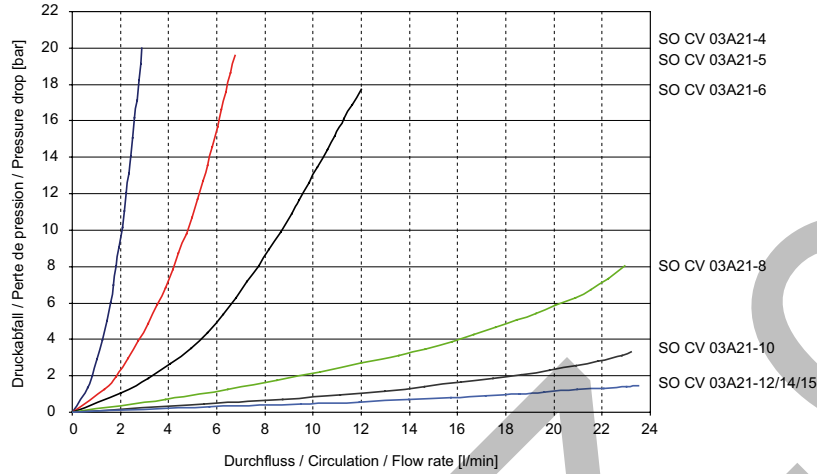

Öffnungsdruckdiagramm

Der Öffnungsdruck bewegt sich im blau skizzierten Bereich. Das Ventil schliesst im rot skizzierten Bereich.

Courbe de pression d'ouverture

La pression d'ouverture se trouve dans la zone indiquée en bleu. La vanne se ferme dans la zone indiquée en rouge.

Opening pressure diagram

The opening pressure ranges within the blue section. The valve closes within the red section.

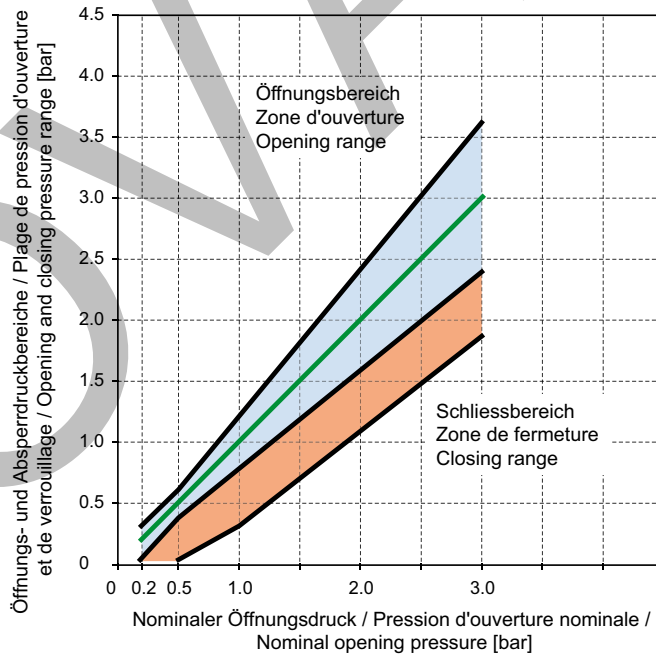

Sonderausführungen

siehe Kapitelübersicht

Exécutions en option

voir aperçu du chapitre

Optional services

see chapter overview

Kegelrückschlagventil
Clapet anti-retour à siège conique
Taper seat non-return valve

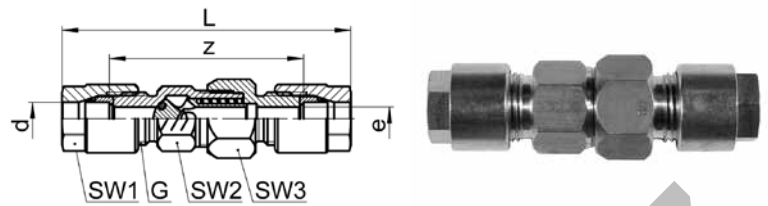
SO CV 03A21

Type-d	Mat.-Nr.	bar	G	SW1	SW2	SW3	L	z	e	kg/100
SO CV 03A21-4	258.3000.040	100	1/8	12	12	14	56.0	42.5	3.4	4.700
SO CV 03A21-5	258.3000.050	100	1/8	12	12	14	56.0	42.5	3.8	4.600
SO CV 03A21-6	258.3000.060	100	1/8	12	12	14	59.0	43.0	3.8	4.800
SO CV 03A21-8	258.3000.080	64	1/4	14	14	17	67.5	48.5	5.8	8.800
SO CV 03A21-10	258.3000.100	64	1/2	19	24	27	88.5	65.0	10.5	26.400
SO CV 03A21-12	258.3000.120	50	1/2	19	24	27	92.0	65.5	10.5	27.000
SO CV 03A21-14	258.3000.140	50	1/2	22	24	27	97.5	66.0	10.5	32.000
SO CV 03A21-15	258.3000.150	50	1/2	22	24	27	97.5	66.0	10.5	29.000

d=Rohrassen-ø
 e=kleinste Bohrung
 L=Mass in montiertem Zustand

d=ø extérieur du tube
 e=ø-min. de passage
 L=après montage

d=tube outside diameter
 e=minimum bore
 L=installed length

Kugelhahn voller Durchgang

Dichtung von innen gesichert

Vanne à bille avec passage intégral

monobloc

Ball valve with full flow

seal locked from the inside

SO BV 08C00

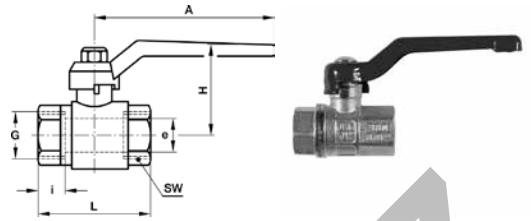

Type -G	Mat.-Nr.	bar	SW	L	A	H	i	e	kg/100
G=Rohrgewinde (zylindrisch)	G=Filetage-gaz BSP (cylindrique)	G=BSP thread (parallel)							
SO BV 08C00-1/4	YBD.7800.001	60	22	48.0	85.0	43.0	12.0	9.0	12.000
SO BV 08C00-3/8	YBD.7800.002	60	22	48.0	82.5	43.0	12.0	11.0	15.400
SO BV 08C00-1/2	YBD.7800.003	60	26	58.0	85.0	44.0	12.0	11.0	22.000
SO BV 08C00-3/4	YBD.7800.004	60	32	70.0	85.0	48.0	15.0	20.0	34.400
SO BV 08C00-1	YBD.7800.005	60	39	83.0	95.0	59.0	18.0	25.0	54.400

Kugelhahn mit vollem Durchgang, Dichtung von innen gesichert.

Spezifikationen

Temperatur: -30°C bis +180°C

Geeignet für: Wasser, Öle, Brennstoffe, Druckluft, saturierter Dampf, nicht korrosive Chemikalien, u.a.

Materialien

Körper und Mutter: Messing 58 vernickelt
Kugelsitz und Dichtung: PTFE
Kugel: Messing CuZn39Pb3 hartverchromt
Griff: Alu-Kunststoffbeschichtung
Sicherungsmutter: Stahl verzinkt

Dienstleistungsoptionen auf Anfrage

Vanne à bille avec passage total, joint intérieur fixé.

Spécifications

Température: -30°C à +180°C

Utilisable pour: eau, huile, mazout, combustible, air comprimé, vapeur saturée, agents chimiques non-corrosifs et autres.

Matériaux

Corps et écrou: laiton 58 nickelé
Logement de bille et joint: PTFE
Bille: laiton CuZn39Pb3, chromage dur
Manette: aluminium plastifié
Écrou de sécurité: acier zingué

Options de service sur demande

Ball valve with full flow, seal locked from the inside.

Specifications

Temperature: -30°C to +180°C

Suitable for: water, oils, fuel, compressed air, saturated steam, non-corrosive chemicals and others.

Materials

Body and nut: nickel-plated brass 58
Ball fit and washer: PTFE
Ball: hard chrome-plated brass CuZn39Pb3
Handle: plastic-coated aluminium
Safety nut: galvanized steel

Optional services on request

Durchgangshahn

mit Dichtkegelanschluss 60°

Vanne simple à passage direct

avec raccordement à étanchéité sur cône 60°

Total-flow cock

with cone seat connection 60°

SO PV 08E01

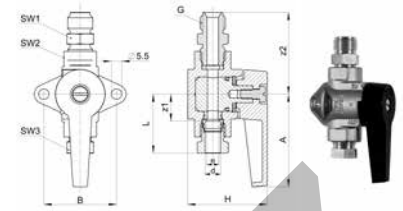

Type -d-G	Mat.-Nr.	bar	SW1	SW2	SW3	L	B	A	H	z1	z2	e	kg/100	
G=Rohrgewinde (zylindrisch)			G=Filetage-gaz BSP (cylindrique)					G=BSP thread (parallel)						
SO PV 08E01-6-1/4 F	258.7810.110	10	14	17	14	31.0	38.0	48.0	41.5	14.0	43.0	5.0	19.500	
SO PV 08E01-6-3/8 F	258.7810.120	10	14	17	17	31.0	38.0	48.0	41.5	14.0	44.0	5.0	20.500	
SO PV 08E01-8-1/4 F	258.7810.170	10	14	17	14	31.0	38.0	48.0	41.5	14.0	43.0	5.5	19.000	
SO PV 08E01-8-3/8 F	258.7810.180	10	14	17	17	31.0	38.0	48.0	41.5	14.0	44.0	5.5	20.000	

Durchgangshahn

Vanne simple à passage direct

Total-flow cock

SO PV 08E21

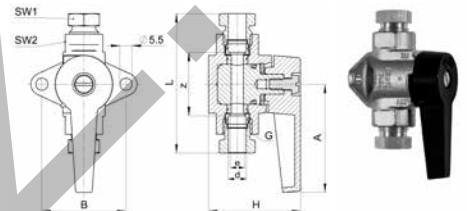

Type -d	Mat.-Nr.	bar	G	SW1	SW2	L	A	H	B	z	e	kg/100
SO PV 08E21-6 F	258.7820.060	10	1/4	14	17	62.0	48.0	41.5	38.0	28.0	5.0	20.000
SO PV 08E21-8 F	258.7820.080	10	1/4	14	17	62.0	48.0	41.5	38.0	28.0	5.5	19.500

Dieser Durchgangshahn hat eine grosse Bohrung. Die Strömung erfährt weder Drosselung noch Umlenkung. Der Durchflusswiderstand ist somit unbedeutend. Der Griff zeigt eindeutig die geöffnete oder geschlossene Stellung an. Die Abdichtung der Bohrung erfolgt mit einer speziellen Dichtbuchse. Bei Ölheizungen wird dieser Hahn gerne als Feuerwehrrahn eingesetzt.

Spzifikationen

Temperatur: max. +80°C

F: mit Befestigungsflansch

Geeignet für: Luft, Öle, Wasser

Materialien

Ventilkörper, Walze, Anschlüsse: Messing CW 617N

Griff: Kunststoff schwarz, auf Wunsch rot

Dichtbuchsen: thermoplastisches PUR

O-Ring: NBR

Cette vanne possède un grand passage direct évitant ainsi tout étranglement ou toute déviation de l'écoulement. La résistance de passage est donc insignifiante. La manette indique clairement la position ouverte ou fermée. L'étanchéité sur le passage est réalisé par un joint spécial. Pour les chauffages à mazout, cette vanne s'installe judicieusement comme robinet coupe-feu.

Spzifikations

Température: max. +80°C

F: flasque de fixations

Utilisable pour: air, huiles et eau

Matériaux

Corps, boisseau cylindrique, écrous: laiton CW 617N

Manette: matière plastique noir, rouge sur demande

Joint spécial: PUR

Joint torique: NBR

This total-flow cock has a large bore the flow is neither throttled nor diverted. Flow resistance is therefore insignificant. The handle indicates clearly and logically the open or closed setting. The bore is sealed off with a special bush. In oil heating systems this cock is popular as a fire fighting accessory.

Specifications

Temperature: max. +80°C

F: with flange mount

Suitable for: air, oils, water

Materials

Valve body, piston, connections: brass CW 617N

Handle: black plastic; red on request

Bush seal: thermoplastic PUR

O-rings: NBR

d=Rohrussen-ø

e=kleinste Bohrung

L=Mass in montiertem Zustand

d=ø extérieur du tube

e=ø-min. de passage

L=après montage

d=tube outside diameter

e=minimum bore

L=installed length

Regulier- / Feinregulier- / Dosierventil
Vanne de réglage / réglage fin / précision
Regulating / fine regulating / metering valve

SO NV 51A21/E/EB/EL
SO NV 51C21/E/EB/EL
SO NV 51D21

12

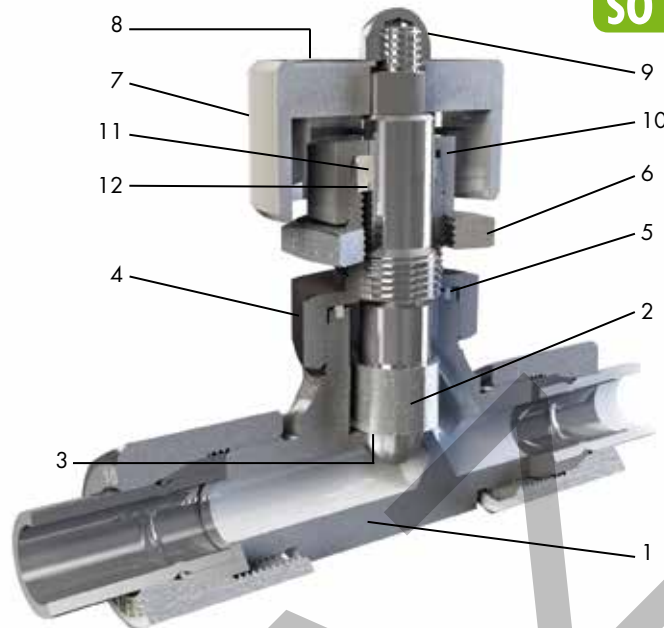

Nr. No. No.	Bezeichnung Désignation Description	Material Matériau Material	Nr. No. No.	Bezeichnung Désignation Description	Material Matériau Material	Nr. No. No.	Bezeichnung Désignation Description	Material Matériau Material
1	Ventilkörper Corps de vanne Valve body	1.4571	5	Dichtung Joint Seal	PTFE (FDA)	9	Hutmutter Écrou borgne Cap nut	CW617N vern.
2	Ventilspindel Pointeau de vanne Valve spindle	1.4571	6	Kontermutter Contre-écrou Counter nut	1.4571	10*	Ventilkappe Bouchon presse-étoupe Valve cap	1.4571
3	Dichtung Joint Seal	PTFE (FDA) 25 % GF	7	Handrad Volant Handwheel	Aluminium	11	Spindeldichtung Joint du pointeau Spindle seal	PTFE (FDA) 25 % GF
4	Schalttafeloberteil Partie sup. tableau de commande Panel top	1.4571	8*	Ventilschild (schwarz) Plaque indicatrice (noir) Valve label (black)	Aluminium	12	Unterlagsscheibe Rondelle Washer	1.4571

Spezifikationen

Betriebsdruck (PN): 64 bis 100 bar
 Temperatur: -40°C bis +180°C
 Sicherheitsfaktor: 1.5-fach

Merkmale

- Funktion: Regulier- und Absperrventil
- Einsatz: Anwendungen mit hohen Anforderungen an die Beständigkeit (Beständigkeit Dichtung beachten)
- Kompakte Abmessungen, hohe Zuverlässigkeit
- Konstruktion ist auf max. Durchfluss ausgelegt

*** Optionen**

- Nr. 8 - Ventilschild: wahlweise auch in den Farben blau, rot, grün, gelb siehe VSD SO NV
- Nr. 10 - Drehmoment für Ventilkappe bei Schalttafelmontage:
Größen 3/5/6/8/1/8"/1/4" = 2 Nm
Größen 10/12/15/3/8" = 2.5 Nm
- Varianten: mit Übergangsmuffe SO 50030 oder Übergangsnippel SO 50040

Spécifications

Pression de service (PN): 64 à 100 bar
 Température: -40°C à +180°C
 Facteur de sécurité: 1.5 fois

Caractéristiques

- Fonction: vanne de régulation et de retenue
- Application: utilisations avec des exigences de résistance élevées (tenir compte de la résistance de l'étanchéité)
- Dimensions compactes, grande fiabilité
- Construction est conçue pour écoulement max.

*** Options**

- No. 8 - Plaques signalétiques: également disponible en couleurs bleu, rouge, vert, jaune voir VSD SO NV
- No. 10 - Couple de serrage pour bouchon de vanne dans tableau de commande:
Dimensions 3/5/6/8/1/8"/1/4" = 2 Nm
Dimensions 10/12/15/3/8" = 2.5 Nm
- Autres versions: avec adaptateur femelle SO 50030 ou mâle SO 50040

Specifications

Working pressure (PN): 64 to 100 bar
 Temperature: -40°C to +180°C
 Safety factor: 1.5 times

Characteristics

- Function: regulating and stop valve
- Uses: applications with high demands for resistance (check resistance of seal)
- Compact dimensions, high reliability
- Constructed for maximum flow

*** Options**

- No. 8 - Valve labels: also available in colors blue, red, green, yellow, see VSD SO NV
- No. 10 - Torque for valve cap in panel mounting:
Sizes 3/5/6/8/1/8"/1/4" = 2 Nm
Sizes 10/12/15/3/8" = 2.5 Nm
- Other versions: with female adaptor SO 50030 or male adaptor SO 50040

Durchflussdiagramm

Courbe de débit

Flow rate

Regulierventile / Vannes de réglage /
Regulating valves

Feinregulierventile / Vannes de réglage fin /
Fine regulating valves

SO NV 51A21

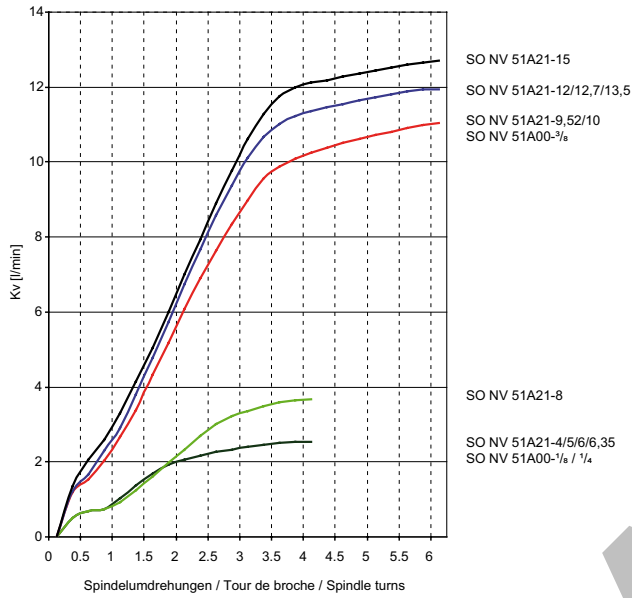

SO NV 51C21

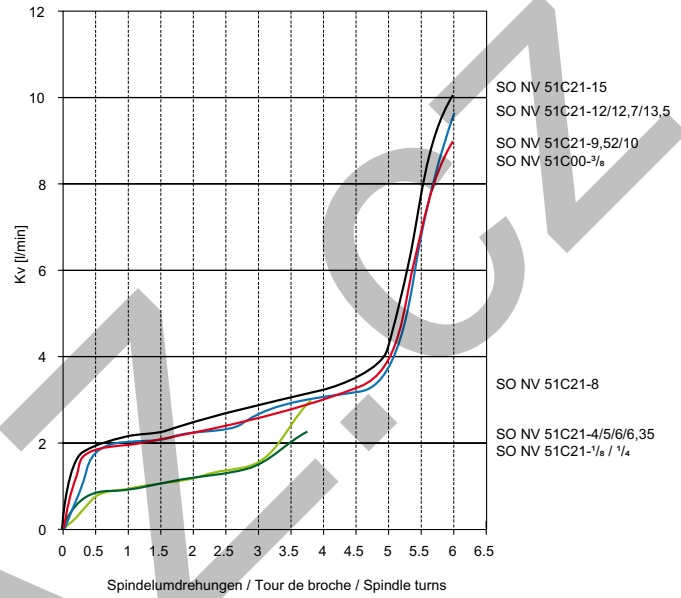

SO NV 51A21E / A21EB / A60EL

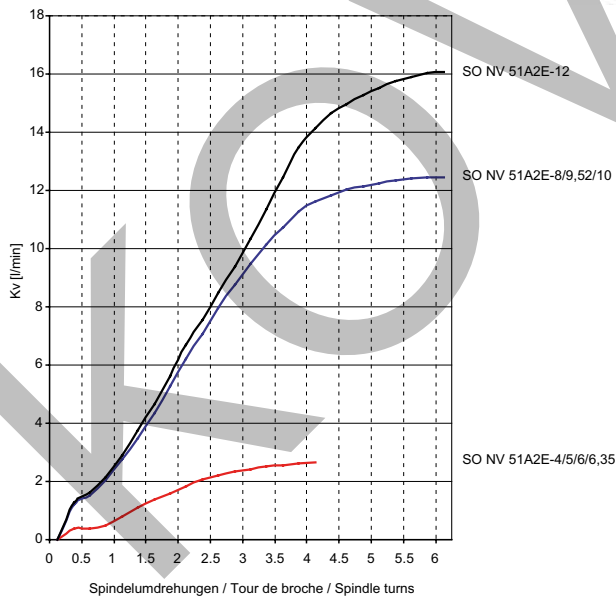

SO NV 51C21E / C21EB / C60EL

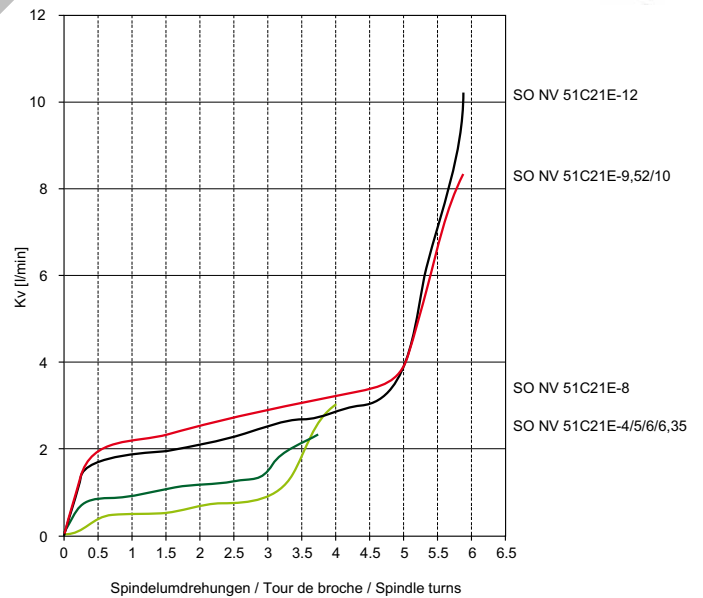

Dosierventile / Vannes de réglage de précision / Metering valves

SO NV 51D21

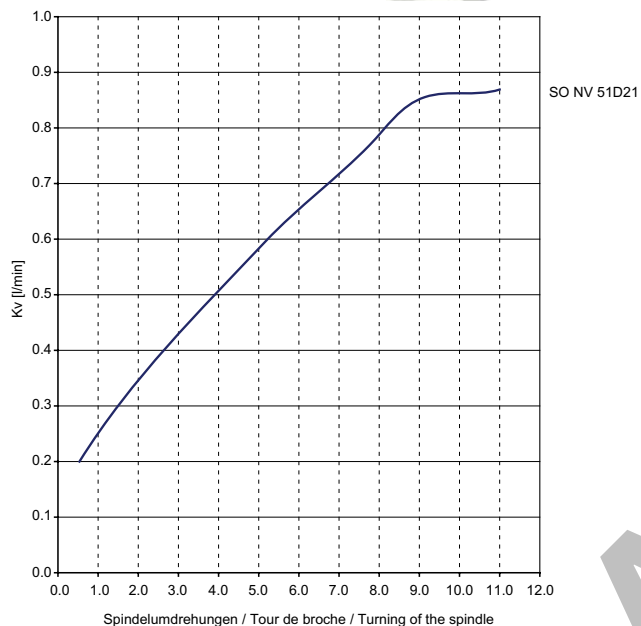

Sonderausführungen
siehe Kapitelübersicht

Exécutions en option
voir aperçu du chapitre

Optional services
see chapter overview

Regulierventil

mit Innengewinde

Vanne de réglage

avec taraudage

Regulating valve

with female thread

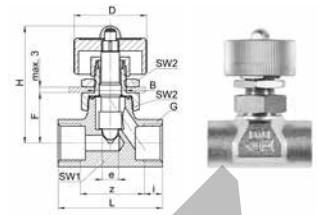

SO NV 51A00

Type -G	Mat.-Nr.	bar	SW1	SW2	L	D	H	B	F	i	z	e	kv	kg/100
G=Rohrgewinde (zylindrisch)			G=Filetage-gaz BSP (cylindrique)					G=BSP thread (parallel)						
SO NV 51A00-1/8	068.0001.020	100	14	14	32.0	20.0	41.0	10.0	14.5	8.5	15.0	3.5	2.5	4.900
SO NV 51A00-1/4	068.0001.040	100	22	14	34.0	20.0	43.0	10.0	16.5	9.5	15.0	3.5	2.5	7.800
SO NV 51A00-3/8	068.0001.060	64	24	22	46.0	32.0	58.0	14.5	22.5	10.0	26.0	7.0	11.5	17.200

Regulierventil

Vanne de réglage

Regulating valve

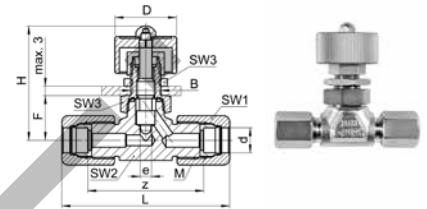

SO NV 51A21

Type -d	Mat.-Nr.	bar	M	SW1	SW2	SW3	L	D	H	B	F	z	e	kv	kg/100
Für metrische Rohre			Pour tubes métriques					For metric tubes							
* SO NV 51A21-4	068.0011.040	100	10x1.0	12	14	14	50.0	20.0	41.0	10.0	14.5	34.0	3.5	2.5	6.900
* SO NV 51A21-5	068.0011.050	100	10x1.0	12	14	14	50.0	20.0	41.0	10.0	14.5	34.0	3.5	2.5	6.800
SO NV 51A21-6	068.0011.060	100	10x1.0	12	14	14	50.0	20.0	41.0	10.0	14.5	34.0	3.5	2.5	6.500
SO NV 51A21-8	068.0011.080	100	12x1.0	14	14	14	54.0	20.0	41.0	10.0	14.5	37.5	3.5	3.5	8.200
SO NV 51A21-10	068.0011.100	64	14x1.0	17	22	22	70.0	32.0	57.5	14.5	21.5	47.5	7.0	11.5	19.000
SO NV 51A21-12	068.0011.120	64	16x1.0	19	22	22	72.0	32.0	57.5	14.5	21.5	47.5	7.0	12.0	20.000
* SO NV 51A21-14	068.0011.140	64	20x1.5	24	24	22	80.0	32.0	57.5	14.5	22.0	52.0	7.0	13.0	30.000
SO NV 51A21-15	068.0011.150	64	20x1.5	24	24	22	79.0	32.0	57.5	14.5	22.0	51.5	7.0	13.0	29.500

Für Zollrohre	Mat.-Nr.	bar	M	SW1	SW2	SW3	L	D	H	B	F	z	e	kv	kg/100
			Pour tubes pouces					For inch tubes							
SO NV 51A21-6,35	068.0011.063	100	10x1.0	12	14	14	50.5	20.0	41.0	10.0	14.5	34.5	3.5	2.5	6.500
SO NV 51A21-9,52	068.0011.095	64	14x1.0	17	22	22	69.0	32.0	57.5	14.5	21.5	47.5	7.0	11.5	18.900
SO NV 51A21-12,7	068.0011.127	64	20x1.5	24	24	22	79.0	32.0	57.5	14.5	22.0	52.0	7.0	13.0	29.100
* SO NV 51A21-13,5	068.0011.135	64	20x1.5	24	24	22	85.0	32.0	57.5	14.5	22.0	52.0	7.0	13.0	30.000

Umrechnung für "d" bei Zollrohren:

- 6,35 = 1/4
- 9,52 = 3/8
- 12,7 = 1/2
- 13,5 = 17/32

Conversion de "d" pour tubes en pouces:

- 6,35 = 1/4
- 9,52 = 3/8
- 12,7 = 1/2
- 13,5 = 17/32

Conversion for "d" for inch tubes:

- 6,35 = 1/4
- 9,52 = 3/8
- 12,7 = 1/2
- 13,5 = 17/32

d=Rohrassen-ø
 e=kleinste Bohrung
 kv=Kenngröße für das Durchflussverhalten (l/min)
 L=Mass in montiertem Zustand
 H=Ventil geöffnet
 *=mit reduziertem Klemmring

d=ø extérieur du tube
 e=ø-min. de passage
 kv=facteur d'écoulement (l/min)
 L=après montage
 H=vanne ouvert
 *=avec bague de serrage de réduction

d=tube outside diameter
 e=minimum bore
 kv=flow factor (l/min)
 L=installed length
 H=valve opened
 *=with reduced compression ferrule

Regulierventil

mit Übergangsmuffe SO 50030

Vanne de réglage

avec adaptateur femelle SO 50030

Regulating valve

with female adaptor SO 50030

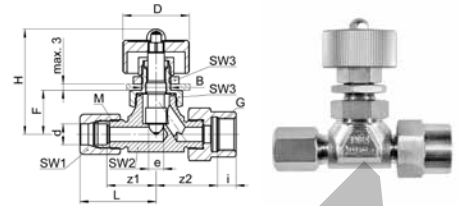
SO NV 51A30

Type -d-G	Mat.-Nr.	bar	M	SW1	SW2	SW3	L	H	B	F	i	z1	z2	e	kv	kg/100	
Für metrische Rohre				Pour tubes métriques													
G=Rohrgewinde (zylindrisch)				G=Filetage-gaz BSP (cylindrique)													
				G=BSP thread (parallel)													
* SO NV 51A30-4-1/8	068.0012.060	100	10x1.0	12	14	14	25.0	41.0	10.0	14.5	10.0	17.0	20.0	3.5	2.5	8.460	
* SO NV 51A30-5-1/8	068.0012.082	100	10x1.0	12	14	14	25.0	41.0	10.0	14.5	10.0	17.0	20.0	3.5	2.5	8.360	
SO NV 51A30-6-1/8	068.0012.100	100	10x1.0	12	14	14	25.0	41.0	10.0	14.5	10.0	17.0	20.0	3.5	2.5	8.060	
SO NV 51A30-6-1/4	068.0012.110	100	10x1.0	12	14	14	25.0	41.0	10.0	14.5	11.0	17.0	20.0	3.5	2.5	8.060	
SO NV 51A30-8-1/8	068.0012.160	100	12x1.0	14	14	14	27.0	41.0	10.0	14.5	10.0	18.5	21.5	3.5	3.5	9.710	
SO NV 51A30-8-1/4	068.0012.170	100	12x1.0	14	14	14	27.0	41.0	10.0	14.5	12.0	18.5	21.5	3.5	3.5	9.300	
SO NV 51A30-8-3/8	068.0012.180	100	12x1.0	14	14	14	27.0	41.0	10.0	14.5	11.0	18.5	21.5	3.5	3.5	11.650	
SO NV 51A30-10-1/4	068.0012.270	64	14x1.0	17	22	22	35.0	57.5	14.5	21.5	12.0	23.5	26.5	7.0	11.0	19.090	
SO NV 51A30-10-3/8	068.0012.280	64	14x1.0	17	22	22	35.0	57.5	14.5	21.5	12.0	23.5	26.5	7.0	11.0	21.270	
SO NV 51A30-12-3/8	068.0012.390	64	16x1.0	19	22	22	36.0	57.5	14.5	21.5	12.0	23.5	26.5	7.0	12.0	21.510	
SO NV 51A30-12-1/2	068.0012.400	64	16x1.0	19	22	22	36.0	57.5	14.5	21.5	12.0	23.5	26.5	7.0	12.0	24.820	
SO NV 51A30-15-1/2	068.0012.534	64	20x1.5	24	24	22	40.0	57.5	14.5	22.0	12.0	26.0	29.5	7.0	13.0	31.890	

Für Zollrohre				Pour tubes pouces														
				For inch tubes														
SO NV 51A30-6,35-1/8	068.0012.135	100	10x1.0	12	14	14	25.0	41.0	10.0	14.5	10.0	17.0	20.0	3.5	2.5	7.320		
SO NV 51A30-9,52-1/4	068.0012.230	64	14x1.0	17	22	22	34.0	57.5	14.5	21.5	12.0	23.5	26.5	7.0	11.0	19.210		
SO NV 51A30-9,52-3/8	068.0012.235	64	14x1.0	17	22	22	37.0	57.5	14.5	21.5	12.0	23.5	26.5	7.0	11.0	21.390		
SO NV 51A30-12,7-1/2	068.0012.434	64	20x1.5	24	24	22	40.0	57.5	14.5	22.0	12.0	26.0	29.5	7.0	13.0	31.120		

Umrechnung für "d" bei Zollrohren:
 6,35 = 1/4
 9,52 = 3/8
 12,7 = 1/2

Conversion de "d" pour tubes en pouces:
 6,35 = 1/4
 9,52 = 3/8
 12,7 = 1/2

Conversion for "d" for inch tubes:
 6,35 = 1/4
 9,52 = 3/8
 12,7 = 1/2

D = ø 20 mm ≤ Anschlussgröße 8
 ø 32 mm ≥ Anschlussgröße 9,52

D = ø 20 mm ≤ Dimension 8
 ø 32 mm ≥ Dimension 9,52

D = ø 20 mm ≤ Dimension 8
 ø 32 mm ≥ Dimension 9,52

Montagehinweis: Muffe ist handfest montiert. Bei Endmontage mit 1/4 Umdrehung anziehen.
 Wir empfehlen eine zusätzliche Schmierung auf der Planfläche.

Note d'installation: L'adaptateur femelle est monté serré à la main. Pour le montage final, serrer avec 1/4 de tour.
 Nous recommandons une lubrification supplémentaire sur la surface plane.

Assembly information: Female adaptor is mounted finger-tight. For final assembly, tighten with 1/4 turn.
 We recommend additional lubrication on the plane surface.

d=Rohrøussen-ø
 e=kleinste Bohrung
 kv=Kenngröße für das Durchflussverhalten (l/min)
 L=Mass in montiertem Zustand
 H=Ventil geöffnet
 *=mit reduziertem Klemmring

d=ø extérieur du tube
 e=ø-min. de passage
 kv=facteur d'écoulement (l/min)
 L=après montage
 H=vanne ouvert
 *=avec bague de serrage de réduction

d=tube outside diameter
 e=minimum bore
 kv=flow factor (l/min)
 L=installed length
 H=valve opened
 *=with reduced compression ferrule

Regulierventil

mit Übergangsnippel SO 50040

Vanne de réglage

avec adaptateur mâle SO 50040

Regulating valve

with male adaptor SO 50040

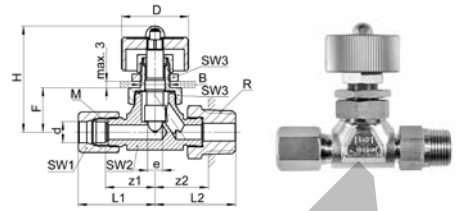
SO NV 51A40

Type -d-R	Mat.-Nr.	bar	M	SW1	SW2	SW3	L1	L2	H	B	F	z1	z2	e	kv	kg/100
Für metrische Rohre R=Rohrgewinde (kegelig)		Pour tubes métriques R=Filetage-gaz BSP (conique)						For metric tubes R=BSP thread (tapered)								
* SO NV 51A40-4-1/8	068.0014.060	100	10x1.0	12	14	14	25.0	27.0	41.0	10.0	14.5	17.0	20.5	3.5	2.5	6.850
* SO NV 51A40-4-1/4	068.0014.065	100	10x1.0	12	14	14	25.0	31.0	41.0	10.0	14.5	17.0	21.5	3.5	2.5	7.820
* SO NV 51A40-5-1/8	068.0014.082	100	10x1.0	12	14	14	25.0	27.0	41.0	10.0	14.5	17.0	20.5	3.5	2.5	6.750
* SO NV 51A40-5-1/4	068.0014.084	100	10x1.0	12	14	14	25.0	31.0	41.0	10.0	14.5	17.0	21.5	3.5	2.5	7.720
SO NV 51A40-6-1/8	068.0014.100	100	10x1.0	12	14	14	25.0	27.0	41.0	10.0	14.5	17.0	20.5	3.5	2.5	7.420
SO NV 51A40-6-1/4	068.0014.110	100	10x1.0	12	14	14	25.0	31.0	41.0	10.0	14.5	17.0	21.5	3.5	2.5	7.420
SO NV 51A40-8-1/8	068.0014.160	100	12x1.0	14	14	14	27.0	28.5	41.0	10.0	14.5	18.5	22.0	3.5	3.5	8.130
SO NV 51A40-8-1/4	068.0014.170	100	12x1.0	14	14	14	27.0	32.5	41.0	10.0	14.5	18.5	23.0	3.5	3.5	8.600
SO NV 51A40-8-3/8	068.0014.180	100	12x1.0	14	14	14	27.0	32.5	41.0	10.0	14.5	18.5	22.5	3.5	3.5	9.950
SO NV 51A40-8-1/2	068.0014.185	100	12x1.0	14	14	14	27.0	36.5	41.0	10.0	14.5	18.5	23.5	3.5	3.5	10.850
SO NV 51A40-10-1/4	068.0014.270	64	14x1.0	17	22	22	35.0	37.5	57.5	14.5	21.5	23.5	28.0	7.0	11.0	18.790
SO NV 51A40-10-3/8	068.0014.280	64	14x1.0	17	22	22	35.0	37.5	57.5	14.5	21.5	23.5	27.5	7.0	11.0	19.500
SO NV 51A40-10-1/2	068.0014.285	64	14x1.0	17	22	22	35.0	38.5	57.5	14.5	21.5	23.5	25.5	7.0	11.0	21.850
SO NV 51A40-12-1/4	068.0014.380	64	16x1.0	19	22	22	36.0	38.5	57.5	14.5	21.5	23.5	29.0	7.0	12.0	19.760
SO NV 51A40-12-3/8	068.0014.390	64	16x1.0	19	22	22	36.0	37.5	57.5	14.5	21.5	23.5	27.5	7.0	12.0	20.010
SO NV 51A40-12-1/2	068.0014.400	64	16x1.0	19	22	22	36.0	41.5	57.5	14.5	21.5	23.5	28.5	7.0	12.0	22.620
SO NV 51A40-15-1/2	068.0014.534	64	20x1.5	24	24	22	39.5	43.5	57.5	14.5	22.0	26.0	30.5	7.0	13.0	29.460

Für Zollrohre

Pour tubes pouces

For inch tubes

SO NV 51A40-6,35-1/8	068.0014.135	100	10x1.0	12	14	14	25.0	27.0	41.0	10.0	14.5	17.0	20.5	3.5	2.5	6.470
SO NV 51A40-6,35-1/4	068.0014.140	100	10x1.0	12	14	14	25.0	31.0	41.0	10.0	14.5	17.0	21.0	3.5	2.5	7.440
SO NV 51A40-9,52-1/4	068.0014.230	64	14x1.0	17	22	22	34.5	37.5	57.5	14.5	21.5	23.5	27.5	7.0	11.0	18.660
SO NV 51A40-9,52-3/8	068.0014.235	64	14x1.0	17	22	22	34.5	37.5	57.5	14.5	21.5	23.5	27.5	7.0	11.0	19.370
SO NV 51A40-9,52-1/2	068.0014.240	64	14x1.0	17	22	22	34.5	38.5	57.5	14.5	21.5	23.5	25.5	7.0	11.0	21.700
SO NV 51A40-12,7-1/2	068.0014.434	64	20x1.5	24	24	22	39.5	43.5	57.5	14.5	22.0	26.0	30.5	7.0	13.0	28.070

Umrechnung für "d" bei Zollrohren:

 6,35 = 1/4
 9,52 = 3/8
 12,7 = 1/2

Conversion de "d" pour tubes en pouces:

 6,35 = 1/4
 9,52 = 3/8
 12,7 = 1/2

Conversion for "d" for inch tubes:

 6,35 = 1/4
 9,52 = 3/8
 12,7 = 1/2

 D = ø 20 mm ≤ Anschlussgröße 8
 ø 32 mm ≥ Anschlussgröße 9,52

 D = ø 20 mm ≤ Dimension 8
 ø 32 mm ≥ Dimension 9,52

 D = ø 20 mm ≤ Dimension 8
 ø 32 mm ≥ Dimension 9,52

Montagehinweis: Nippel ist handfest montiert. Bei Endmontage mit 1/4 Umdrehung anziehen.

Wir empfehlen eine zusätzliche Schmierung auf der Planfläche.

Note d'installation: L'adaptateur femelle-mâle est monté serré à la main. Pour le montage final, serrer avec 1/4 de tour.

Nous recommandons une lubrification supplémentaire sur la surface plane.

Assembly information: Male adaptor is mounted finger-tight. For final assembly, tighten with 1/4 turn.

We recommend additional lubrication on the plane surface.

 d=Rohrassens-ø
 e=kleinste Bohrung
 kv=Kenngröße für das Durchflussverhalten (l/min)
 L=Mass in montiertem Zustand
 H=Ventil geöffnet
 *=mit reduziertem Klemmring

 d=ø extérieur du tube
 e=ø-min. de passage
 kv=facteur d'écoulement (l/min)
 L=après montage
 H=vanne ouvert
 *=avec bague de serrage de réduction

 d=tube outside diameter
 e=minimum bore
 kv=flow factor (l/min)
 L=installed length
 H=valve opened
 *=with reduced compression ferrule

Feinregulierventil

mit Innengewinde

Vanne de réglage fin

avec taraudage

Fine regulating valve

with female thread

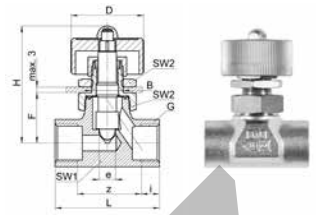
SO NV 51C00

Type -G	Mat.-Nr.	bar	SW1	SW2	L	D	H	B	F	i	z	e	kv	kg/100
G=Rohrgewinde (zylindrisch)			G=Filetage-gaz BSP (cylindrique)						G=BSP thread (parallel)					
SO NV 51C00-1/8	068.0101.020	100	14	14	32.0	20.0	41.0	10.0	14.5	8.5	15.0	3.5	2.5	5.200
SO NV 51C00-1/4	068.0101.040	100	22	14	34.0	20.0	43.0	10.0	16.5	9.5	15.0	3.5	2.5	8.100
SO NV 51C00-3/8	068.0101.060	64	24	22	46.0	32.0	58.0	14.5	22.5	10.0	26.0	7.0	9.0	19.000

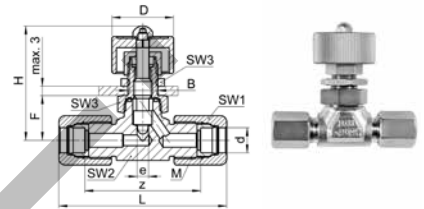
Feinregulierventil
Vanne de réglage fin
Fine regulating valve

SO NV 51C21

Type -d	Mat.-Nr.	bar	M	SW1	SW2	SW3	L	D	H	B	F	z	e	kv	kg/100
Für metrische Rohre			Pour tubes métriques						For metric tubes						
* SO NV 51C21-4	068.0111.040	100	10x1.0	12	14	14	50.0	20.0	41.0	10.0	14.5	34.0	3.5	2.5	7.200
* SO NV 51C21-5	068.0111.050	100	10x1.0	12	14	14	50.0	20.0	41.0	10.0	14.5	34.0	3.5	2.5	7.100
SO NV 51C21-6	068.0111.060	100	10x1.0	12	14	14	50.0	20.0	41.0	10.0	14.5	34.0	3.5	2.5	7.200
SO NV 51C21-8	068.0111.080	100	12x1.0	14	14	14	54.0	20.0	41.0	10.0	14.5	37.5	3.5	3.5	8.600
SO NV 51C21-10	068.0111.100	64	14x1.0	17	19	22	70.0	32.0	57.5	14.5	21.5	47.5	7.0	9.0	20.800
SO NV 51C21-12	068.0111.120	64	16x1.0	19	19	22	72.0	32.0	57.5	14.5	21.5	47.5	7.0	9.5	21.900
* SO NV 51C21-14	068.0111.140	64	20x1.5	24	24	22	80.0	32.0	57.5	14.5	22.0	52.0	7.0	10.0	31.700
SO NV 51C21-15	068.0111.150	64	20x1.5	24	24	22	79.0	32.0	57.5	14.5	22.0	51.5	7.0	10.0	31.200
Für Zollrohre			Pour tubes pouces						For inch tubes						
SO NV 51C21-6,35	068.0111.063	100	10x1.0	12	14	14	50.5	20.0	41.0	10.0	14.5	34.0	3.5	2.5	7.000
SO NV 51C21-9,52	068.0111.095	64	14x1.0	17	22	22	69.0	32.0	57.5	14.5	21.5	47.5	7.0	9.0	20.700
SO NV 51C21-12,7	068.0111.127	64	20x1.5	24	24	22	79.0	32.0	57.5	14.5	22.0	52.0	7.0	10.0	30.900
* SO NV 51C21-13,5	068.0111.135	64	20x1.5	24	24	22	85.0	32.0	57.5	14.5	22.0	52.0	7.0	10.0	31.700

Umrechnung für "d" bei Zollrohren:

 6,35 = 1/4
 9,52 = 3/8
 12,7 = 1/2
 13,5 = 17/32

Conversion de "d" pour tubes en pouces:

 6,35 = 1/4
 9,52 = 3/8
 12,7 = 1/2
 13,5 = 17/32

Conversion for "d" for inch tubes:

 6,35 = 1/4
 9,52 = 3/8
 12,7 = 1/2
 13,5 = 17/32

d=Rohraussen-ø

e=kleinste Bohrung

kv=Kenngröße für das Durchflussverhalten (l/min)

L=Mass in montiertem Zustand

H=Ventil geöffnet

*=mit reduziertem Klemmring

d=ø extérieur du tube

e=ø-min. de passage

kv=facteur d'écoulement (l/min)

L=après montage

H=vanne ouvert

*=avec bague de serrage de réduction

d=tube outside diameter

e=minimum bore

kv=flow factor (l/min)

L=installed length

H=valve opened

*=with reduced compression ferrule

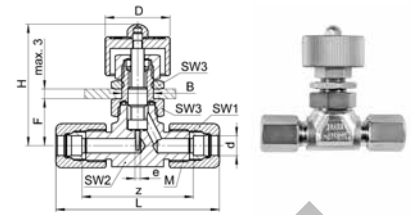
Dosierventil
Vanne de réglage de précision
Metering valve

SO NV 51D21

Type -d	Mat.-Nr.	bar	M	SW1	SW2	SW3	L	D	H	B	F	z	e	kv	kg/100
Für metrische Rohre			Pour tubes métriques						For metric tubes						
* SO NV 51D21-5	068.0611.050	100	10x1.0	12	14	14	50.5	20.0	42.5	10.0	14.5	34.0	1.6	0.8	7.300
SO NV 51D21-6	068.0611.060	100	10x1.0	12	14	14	50.5	20.0	42.5	10.0	14.5	34.0	1.6	0.8	7.300

d=Rohrassen-ø
 e=kleinste Bohrung
 kv=Kenngröße für das Durchflussverhalten (l/min)
 L=Mass in montiertem Zustand
 H=Ventil geöffnet
 *=mit reduziertem Klemmring

d=ø extérieur du tube
 e=ø-min. de passage
 kv=facteur d'écoulement (l/min)
 L=après montage
 H=vanne ouvert
 *=avec bague de serrage de réduction

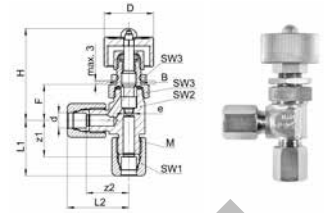
d=tube outside diameter
 e=minimum bore
 kv=flow factor (l/min)
 L=installed length
 H=valve opened
 *=with reduced compression ferrule

Regulier-Eckventil
Vanne-équerre de réglage
Elbow regulating valve

SO NV 51A21E

Type -d	Mat.-Nr.	bar	M	SW1	SW2	SW3	L1	L2	H	B	F	z1	z2	e	kv	kg/100	
Für metrische Rohre		Pour tubes métriques						For metric tubes									
* SO NV 51A21E-4	068.0020.040	100	10x1.0	12	14	14	22.5	25.0	41.0	10.0	15.0	14.5	17.0	3.5	3.0	6.600	
* SO NV 51A21E-5	068.0020.050	100	10x1.0	12	14	14	22.5	25.0	41.0	10.0	15.0	14.5	17.0	3.5	3.0	6.600	
SO NV 51A21E-6	068.0020.060	100	10x1.0	12	14	14	22.5	25.0	41.0	10.0	15.0	14.5	17.0	3.5	3.0	6.300	
* SO NV 51A21E-8	068.0020.080	64	14x1.0	17	22	22	28.5	35.0	57.5	14.5	21.5	17.5	24.0	6.5	12.5	18.000	
SO NV 51A21E-10	068.0020.100	64	14x1.0	17	22	22	28.5	35.0	57.5	14.5	21.5	17.0	23.5	7.0	12.5	17.600	
SO NV 51A21E-12	068.0020.120	64	16x1.0	19	22	22	30.5	36.0	57.5	14.5	21.5	18.0	23.5	7.0	16.0	18.800	
Für Zollrohre		Pour tubes pouces						For inch tubes									
SO NV 51A21E-6,35	068.0020.063	100	10x1.0	12	14	14	22.5	25.0	41.0	10.0	15.0	14.5	17.0	3.5	3.0	6.300	
SO NV 51A21E-9,52	068.0020.095	64	14x1.0	17	22	22	28.0	34.5	57.5	14.5	21.5	17.0	23.5	7.0	12.5	17.900	

Umrechnung für "d" bei Zollrohren:

 6,35 = 1/4
 9,52 = 3/8

Conversion de "d" pour tubes en pouces:

 6,35 = 1/4
 9,52 = 3/8

Conversion for "d" for inch tubes:

 6,35 = 1/4
 9,52 = 3/8

 D = ø 20 mm ≤ Anschlussgröße 6,35
 ø 32 mm ≥ Anschlussgröße 8

 D = ø 20 mm ≤ Dimension 6,35
 ø 32 mm ≥ Dimension 8

 D = ø 20 mm ≤ Dimension 6,35
 ø 32 mm ≥ Dimension 8

 d=Rohrassen-ø
 e=kleinste Bohrung
 kv=Kenngröße für das Durchflussverhalten (l/min)
 L=Mass in montiertem Zustand
 H=Ventil geöffnet
 *=mit reduziertem Klemmring

 d=ø extérieur du tube
 e=ø-min. de passage
 kv=facteur d'écoulement (l/min)
 L=après montage
 H=vanne ouvert
 *=avec bague de serrage de réduction

 d=tube outside diameter
 e=minimum bore
 kv=flow factor (l/min)
 L=installed length
 H=valve opened
 *=with reduced compression ferrule

Regulier-Eckventil

mit Übergangsmuffe SO 50030

Vanne-équerre de réglage

avec adaptateur femelle SO 50030

Elbow regulating valve

with female adaptor SO 50030

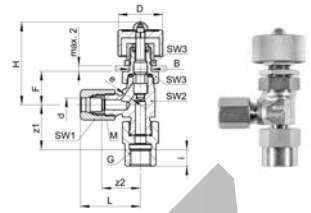

SO NV 51A30E

Type -d-G	Mat.-Nr.	bar	M	SW1	SW2	SW3	L	H	B	F	i	z1	z2	e	kv	kg/100
Für metrische Rohre				Pour tubes métriques								For metric tubes				
G=Rohrgewinde (zylindrisch)				G=Filetage-gaz BSP (cylindrique)								G=BSP thread (parallel)				
* SO NV 51A30E-4-1/8	068.0022.060	100	10x1.0	12	14	14	25.0	41.0	10.0	15.0	7.5	20.0	17.0	3.5	3.0	7.290
* SO NV 51A30E-5-1/8	068.0022.082	100	10x1.0	12	14	14	25.0	41.0	10.0	15.0	7.5	20.0	17.0	3.5	3.0	7.290
SO NV 51A30E-6-1/8	068.0022.100	100	10x1.0	12	14	14	35.0	41.0	10.0	15.0	7.5	20.0	17.0	3.5	3.0	6.990
* SO NV 51A30E-8-1/4	068.0022.170	64	14x1.0	17	22	22	35.0	57.5	14.5	21.5	8.0	23.0	24.0	6.5	12.5	18.390
* SO NV 51A30E-8-3/8	068.0022.180	64	14x1.0	17	22	22	35.0	57.5	14.5	21.5	9.0	23.0	24.0	6.5	12.5	21.020
SO NV 51A30E-10-1/4	068.0022.270	64	14x1.0	17	22	22	35.0	57.5	14.5	21.5	8.0	23.0	24.0	7.0	12.5	17.690
SO NV 51A30E-10-3/8	068.0022.280	64	14x1.0	17	22	22	35.0	57.5	14.5	21.5	9.0	23.0	24.0	7.0	12.5	19.870
SO NV 51A30E-12-1/2	068.0022.400	64	16x1.0	19	22	22	36.0	57.5	14.5	21.5	9.5	25.5	24.0	7.0	16.0	23.620
Für Zollrohre				Pour tubes pouces								For inch tubes				
SO NV 51A30E-6,35-1/8	068.0022.135	100	10x1.0	12	14	14	25.0	41.0	10.0	15.0	7.5	20.0	17.0	3.5	3.0	7.010
SO NV 51A30E-9,52-1/4	068.0022.230	64	14x1.0	17	22	22	34.5	57.5	14.5	21.5	8.0	23.0	24.0	7.0	12.5	17.960
SO NV 51A30E-9,52-3/8	068.0022.235	64	14x1.0	17	22	22	34.5	57.5	14.0	21.5	9.0	23.0	24.0	7.0	12.5	20.140

Umrechnung für "d" bei Zollrohren:

6,35 = 1/4
9,52 = 3/8

Conversion de "d" pour tubes en pouces:

6,35 = 1/4
9,52 = 3/8

Conversion for "d" for inch tubes:

6,35 = 1/4
9,52 = 3/8

D = ø 20 mm ≤ Anschlussgröße 6,35
ø 32 mm ≥ Anschlussgröße 8

D = ø 20 mm ≤ Dimension 6,35
ø 32 mm ≥ Dimension 8

D = ø 20 mm ≤ Dimension 6,35
ø 32 mm ≥ Dimension 8

Montagehinweis: Muffe ist handfest montiert. Bei Endmontage mit 1/4 Umdrehung anziehen.

Wir empfehlen eine zusätzliche Schmierung auf der Planfläche.

Note d'installation: L'adaptateur femelle est monté serré à la main. Pour le montage final, serrer avec 1/4 de tour.

Nous recommandons une lubrification supplémentaire sur la surface plane.

Assembly information: Female adaptor is mounted finger-tight. For final assembly, tighten with 1/4 turn.

We recommend additional lubrication on the plane surface.

d=Rohrassen-ø
e=kleinste Bohrung
kv=Kenngröße für das Durchflussverhalten (l/min)
L=Mass in montiertem Zustand
H=Ventil geöffnet
*=mit reduziertem Klemmring

d=ø extérieur du tube
e=ø-min. de passage
kv=facteur d'écoulement (l/min)
L=après montage
H=vanne ouvert
*=avec bague de serrage de réduction

d=tube outside diameter
e=minimum bore
kv=flow factor (l/min)
L=installed length
H=valve opened
*=with reduced compression ferrule

Regulier-Eckventil

mit Übergangsnippel SO 50040

Vanne-équerre de réglage

avec adaptateur mâle SO 50040

Elbow regulating valve

with male adaptor SO 50040

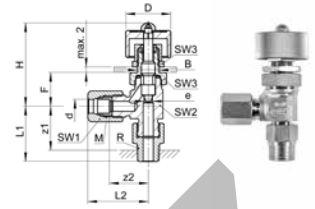
SO NV 51A40E

Type -d-R	Mat.-Nr.	bar	M	SW1	SW2	SW3	L1	L2	H	B	F	z1	z2	e	kv	kg/100
Für metrische Rohre R=Rohrgewinde (kegelig)				Pour tubes métriques R=Filetage-gaz BSP (conique)								For metric tubes R=BSP thread (tapered)				
* SO NV 51A40E-4-1/4	068.0023.065	100	10x1.0	12	14	14	28.5	25.0	41.0	10.0	15.0	20.5	17.0	3.5	3.0	7.520
* SO NV 51A40E-5-1/4	068.0023.084	100	10x1.0	12	14	14	28.5	25.0	41.0	10.0	15.0	20.5	17.0	3.5	3.0	7.520
* SO NV 51A40E-8-3/8	068.0023.180	64	14x1.0	17	22	22	31.0	35.0	57.5	14.5	15.0	23.0	23.5	6.5	12.5	18.800
* SO NV 51A40E-8-1/2	068.0023.185	64	14x1.0	17	22	22	32.0	35.0	57.5	14.5	21.5	22.0	23.5	6.5	12.5	21.130
SO NV 51A40E-10-1/4	068.0023.270	64	14x1.0	17	22	22	31.0	35.0	57.5	14.5	21.5	23.0	23.5	7.0	12.5	17.800
SO NV 51A40E-10-3/8	068.0023.280	64	14x1.0	17	22	22	31.0	35.0	57.5	14.5	21.5	23.0	23.5	7.0	12.5	18.100
SO NV 51A40E-10-1/2	068.0023.285	64	14x1.0	17	22	22	32.0	35.0	57.5	14.5	21.5	22.0	23.5	7.0	12.5	20.430
SO NV 51A40E-12-1/2	068.0023.400	64	16x1.0	19	22	22	36.0	36.0	57.5	14.5	21.5	26.0	23.5	7.0	16.0	21.420
Für Zollrohre				Pour tubes pouces								For inch tubes				
SO NV 51A40E-9,52-1/4	068.0023.230	64	14x1.0	17	22	22	31.0	34.5	57.5	14.5	21.5	23.0	23.5	7.0	12.5	17.660
SO NV 51A40E-9,52-3/8	068.0023.235	64	14x1.0	17	22	22	31.0	34.5	57.5	14.5	21.5	23.0	23.5	7.0	12.5	18.370
SO NV 51A40E-9,52-1/2	068.0023.240	64	14x1.0	17	22	22	32.0	34.5	57.5	14.5	21.5	22.0	23.5	7.0	12.5	20.700

 Umrechnung für "d" bei Zollrohren:
 $9,52 = 3/8$

 Conversion de "d" pour tubes en pouces:
 $9,52 = 3/8$

 Conversion for "d" for inch tubes:
 $9,52 = 3/8$
 $D = \varnothing 20 \text{ mm} \leq \text{Anschlussgrösse } 5$
 $\varnothing 32 \text{ mm} \geq \text{Anschlussgrösse } 8$
 $D = \varnothing 20 \text{ mm} \leq \text{Dimension } 5$
 $\varnothing 32 \text{ mm} \geq \text{Dimension } 8$
 $D = \varnothing 20 \text{ mm} \leq \text{Dimension } 5$
 $\varnothing 32 \text{ mm} \geq \text{Dimension } 8$

Montagehinweis: Nippel ist handfest montiert. Bei Endmontage mit 1/4 Umdrehung anziehen.
 Wir empfehlen eine zusätzliche Schmierung auf der Planfläche.

Note d'installation: L'adaptateur femelle-mâle est monté serré à la main. Pour le montage final, serrer avec 1/4 de tour.
 Nous recommandons une lubrification supplémentaire sur la surface plane.

Assembly information: Male adaptor is mounted finger-tight. For final assembly, tighten with 1/4 turn.
 We recommend additional lubrication on the plane surface.

d=Rohrassen- \varnothing
 e=kleinste Bohrung
 kv=Kenngrösse für das Durchflussverhalten (l/min)
 L=Mass in montiertem Zustand
 H=Ventil geöffnet
 *=mit reduziertem Klemmring

d= \varnothing extérieur du tube
 e= \varnothing -min. de passage
 kv=facteur d'écoulement (l/min)
 L=après montage
 H=vanne ouvert
 *=avec bague de serrage de réduction

d=tube outside diameter
 e=minimum bore
 kv=flow factor (l/min)
 L=installed length
 H=valve opened
 *=with reduced compression ferrule

Regulier-Eckventil

mit Einschraubgewinde

Vanne-équerre de réglage

avec filetage

Elbow regulating valve

with male thread

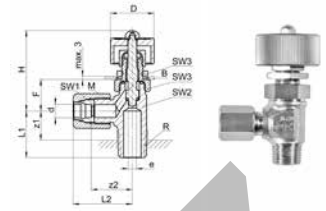

SO NV 51A21EB

Type -d -R	Mat.-Nr.	bar	M	SW1	SW2	SW3	L1	L2	H	B	F	z1	z2	e	kv	kg/100	
Für metrische Rohre R=Rohrgewinde (kegelig)		Pour tubes métriques R=Filetage-gaz BSP (conique)						For metric tubes R=BSP thread (tapered)									
* SO NV 51A21EB-4-1/8	068.0021.060	100	10x1.0	12	14	14	14.5	25.0	41.0	10.0	15.0	9.5	17.0	3.5	3.0	5.700	
* SO NV 51A21EB-5-1/8	068.0021.082	100	10x1.0	12	14	14	14.5	25.0	41.0	10.0	15.0	9.5	17.0	3.5	3.0	5.600	
SO NV 51A21EB-6-1/8	068.0021.100	100	10x1.0	12	14	14	14.5	25.0	41.0	10.0	15.0	9.5	17.0	3.5	3.0	5.500	
* SO NV 51A21EB-6-1/4	068.0021.110	100	12x1.0	14	14	14	21.5	27.0	41.0	10.0	15.0	13.5	19.0	5.0	3.0	6.700	
SO NV 51A21EB-8-1/4	068.0021.170	100	12x1.0	14	14	14	21.5	27.0	41.0	10.0	15.0	13.5	18.0	3.5	12.5	6.400	
SO NV 51A21EB-10-3/8	068.0021.280	64	14x1.0	17	22	22	22.0	35.0	57.5	14.5	21.5	14.0	23.0	7.0	12.5	16.300	
SO NV 51A21EB-12-3/8	068.0021.390	64	16x1.0	19	22	22	24.0	36.0	57.5	14.5	21.5	16.0	23.0	7.0	16.0	17.200	

Für Zollrohre

Pour tubes pouces

For inch tubes

SO NV 51A21EB-6,35-1/8	068.0021.135	100	10x1.0	12	14	14	14.5	25.0	41.0	10.0	15.0	9.5	17.0	3.5	3.0	5.500
SO NV 51A21EB-9,52-3/8	068.0021.235	64	14x1.0	17	22	22	22.0	34.5	57.5	14.5	21.5	14.0	23.5	7.0	12.5	16.500

Umrechnung für "d" bei Zollrohren:

$$6,35 = 1/4$$

$$9,52 = 3/8$$

Conversion de "d" pour tubes en pouces:

$$6,35 = 1/4$$

$$9,52 = 3/8$$

Conversion for "d" for inch tubes:

$$6,35 = 1/4$$

$$9,52 = 3/8$$

D = ø 20 mm ≤ Anschlussgröße 8
ø 32 mm ≥ Anschlussgröße 9,52

D = ø 20 mm ≤ Dimension 8
ø 32 mm ≥ Dimension 9,52

D = ø 20 mm ≤ Dimension 8
ø 32 mm ≥ Dimension 9,52

Regulier-Eckventil

mit Einstellzapfen

Vanne-équerre de réglage

orientable

Elbow regulating valve

adjustable

SO NV 51A60EL

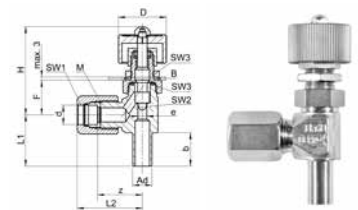

Type -d -Ad	Mat.-Nr.	bar	M	SW1	SW2	SW3	L1	L2	H	B	F	b	z	e	kv	kg/100
SO NV 51A60EL-6-A6	068.0026.060	100	10x1.0	12	14	14	20.5	27.5	41.0	10.0	15.0	13.0	19.5	3.5	3.0	6.310
SO NV 51A60EL-8-A8	068.0026.080	100	12x1.0	14	14	14	20.5	27.0	41.0	10.0	15.0	14.0	18.5	3.5	12.5	6.670

D = ø 20 mm

D = ø 20 mm

D = ø 20 mm

d=Rohraussen-ø

Ad=Aussen-ø der Andrehung

kv=Kenngröße für das Durchflussverhalten (l/min)

L=Mass in montiertem Zustand

H=Ventil geöffnet

*=mit reduziertem Klemmring

d=ø extérieur du tube

Ad=ø extérieur de la portée cylindrique

kv=facteur d'écoulement (l/min)

L=après montage

H=vanne ouvert

*=avec bague de serrage de réduction

d=tube outside diameter

Ad=outside diameter of cyl. stub

kv=flow factor (l/min)

L=installed length

H=valve opened

*=with reduced compression ferrule

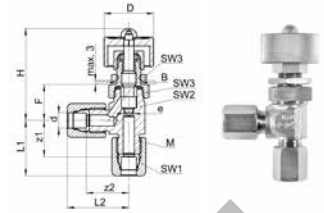
Feinregulier-Eckventil
Vanne-équerre de réglage fin
Elbow fine regulating valve

SO NV 51C21E

Type -d	Mat.-Nr.	bar	M	SW1	SW2	SW3	L1	L2	H	B	F	z1	z2	e	kv	kg/100	
Für metrische Rohre		Pour tubes métriques						For metric tubes									
* SO NV 51C21E-4	068.0120.040	100	10x1.0	12	14	14	22.5	25.0	41.0	10.0	15.0	14.5	17.0	3.5	2.5	7.100	
* SO NV 51C21E-5	068.0120.050	100	10x1.0	12	14	14	22.5	25.0	41.0	10.0	15.0	14.5	17.0	3.5	2.5	7.000	
SO NV 51C21E-6	068.0120.060	100	10x1.0	12	14	14	22.5	25.0	41.0	10.0	15.0	14.5	17.0	3.5	2.5	6.700	
* SO NV 51C21E-8	068.0120.080	64	14x1.0	17	22	22	28.5	35.0	57.5	14.5	21.5	17.5	24.0	6.5	3.0	20.300	
SO NV 51C21E-10	068.0120.100	64	14x1.0	17	22	22	28.5	35.0	57.5	14.5	21.5	17.0	23.5	7.0	8.5	19.400	
SO NV 51C21E-12	068.0120.120	64	16x1.0	19	22	22	30.5	36.0	57.5	14.5	21.5	18.0	23.5	7.0	10.5	21.200	
Für Zollrohre		Pour tubes pouces						For inch tubes									
SO NV 51C21E-6,35	068.0120.063	100	10x1.0	12	14	14	22.5	25.0	41.0	10.0	15.0	14.5	17.0	3.5	2.5	6.700	
SO NV 51C21E-9,52	068.0120.095	64	14x1.0	17	22	22	28.0	34.5	57.5	14.5	21.5	17.0	23.5	7.0	8.5	19.800	

Umrechnung für "d" bei Zollrohren:

6,35 = 1/4

9,52 = 3/8

Conversion de "d" pour tubes en pouces:

6,35 = 1/4

9,52 = 3/8

Conversion for "d" for inch tubes:

6,35 = 1/4

9,52 = 3/8

 D = \varnothing 20 mm \leq Anschlussgröße 6,35
 \varnothing 32 mm \geq Anschlussgröße 8

 D = \varnothing 20 mm \leq Dimension 6,35
 \varnothing 32 mm \geq Dimension 8

 D = \varnothing 20 mm \leq Dimension 6,35
 \varnothing 32 mm \geq Dimension 8

d=Rohrassen- \varnothing
 e=kleinste Bohrung
 kv=Kenngröße für das Durchflussverhalten (l/min)
 L=Mass in montiertem Zustand
 H=Ventil geöffnet
 *=mit reduziertem Klemmring

d= \varnothing extérieur du tube
 e= \varnothing -min. de passage
 kv=facteur d'écoulement (l/min)
 L=après montage
 H=vanne ouvert
 *=avec bague de serrage de réduction

d=tube outside diameter
 e=minimum bore
 kv=flow factor (l/min)
 L=installed length
 H=valve opened
 *=with reduced compression ferrule

Feinregulier-Eckventil

mit Einschraubgewinde

Vanne-équerre de réglage fin

avec filetage

Elbow fine regulating valve

with male thread

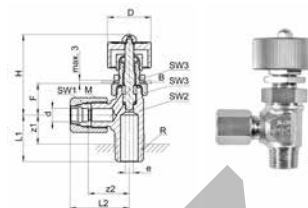
SO NV 51C21EB

Type -d -R	Mat.-Nr.	bar	M	SW1	SW2	SW3	L1	L2	H	B	F	z1	z2	e	kv	kg/100	
Für metrische Rohre R=Rohrgewinde (kegelig)		Pour tubes métriques R=Filetage-gaz BSP (conique)						For metric tubes R=BSP thread (tapered)									
* SO NV 51C21EB-4-1/8	068.0121.060	100	10x1.0	12	14	14	14.5	25.0	41.0	10.0	15.0	9.5	17.0	3.5	2.5	5.700	
* SO NV 51C21EB-5-1/8	068.0121.082	100	10x1.0	12	14	14	14.5	25.0	41.0	10.0	15.0	9.5	17.0	3.5	2.5	6.100	
SO NV 51C21EB-6-1/8	068.0121.100	100	10x1.0	12	14	14	14.5	25.0	41.0	10.0	15.0	9.5	17.0	3.5	2.5	5.900	
* SO NV 51C21EB-6-1/4	068.0121.110	100	12x1.0	14	14	14	21.5	27.0	41.0	10.0	15.0	13.5	18.0	3.5	2.5	7.200	
SO NV 51C21EB-8-1/4	068.0121.170	100	12x1.0	14	14	14	21.5	27.0	41.0	10.0	15.0	13.5	18.0	3.5	3.0	6.900	
SO NV 51C21EB-10-3/8	068.0121.280	64	14x1.0	17	22	22	22.0	35.0	57.5	14.5	21.5	14.0	23.0	7.0	8.5	18.200	
SO NV 51C21EB-12-3/8	068.0121.390	64	16x1.0	19	22	22	24.0	36.0	57.5	14.5	21.5	16.0	23.0	7.0	10.5	19.400	

Für Zollrohre

Pour tubes pouces

For inch tubes

SO NV 51C21EB-6,35-1/8	068.0121.135	100	10x1.0	12	14	14	14.5	25.0	41.0	10.0	15.0	9.5	17.0	3.5	2.5	5.900
SO NV 51C21EB-9,52-3/8	068.0121.235	64	14x1.0	17	22	22	22.0	34.5	57.5	14.5	21.5	14.0	23.5	7.0	8.5	18.400

Umrechnung für "d" bei Zollrohren:

$$6,35 = 1/4$$

$$9,52 = 3/8$$

Conversion de "d" pour tubes en pouces:

$$6,35 = 1/4$$

$$9,52 = 3/8$$

Conversion for "d" for inch tubes:

$$6,35 = 1/4$$

$$9,52 = 3/8$$

 D = \varnothing 20 mm \leq Anschlussgröße 8
 \varnothing 32 mm \geq Anschlussgröße 9,52

 D = \varnothing 20 mm \leq Dimension 8
 \varnothing 32 mm \geq Dimension 9,52

 D = \varnothing 20 mm \leq Dimension 8
 \varnothing 32 mm \geq Dimension 9,52

Feinregulier-Eckventil

mit Einstellzapfen

Vanne-équerre de réglage fin

orientable

Elbow fine regulating valve

adjustable

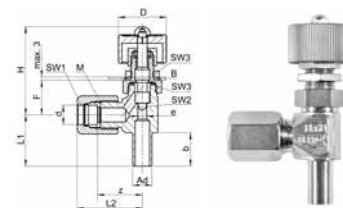
SO NV 51C60EL

Type -d -Ad	Mat.-Nr.	bar	M	SW1	SW2	SW3	L1	L2	H	B	F	b	z	e	kv	kg/100
SO NV 51C60EL-6-A6	068.0126.060	100	10x1.0	12	14	14	20.5	27.5	41.0	10.0	15.0	13.0	19.5	3.5	2.5	5.900
SO NV 51C60EL-8-A8	068.0126.080	100	12x1.0	14	14	14	20.5	27.0	41.0	10.0	15.0	14.0	18.5	3.5	3.0	6.600

 D = \varnothing 20 mm

 D = \varnothing 20 mm

 D = \varnothing 20 mm

 d=Rohraussen- \varnothing

 Ad=Aussen- \varnothing der Andrehung

kv=Kenngröße für das Durchflussverhalten (l/min)

L=Mass in montiertem Zustand

H=Ventil geöffnet

*=mit reduziertem Klemmring

 d= \varnothing extérieur du tube

 Ad= \varnothing extérieur de la portée cylindrique

kv=facteur d'écoulement (l/min)

L=après montage

H=vanne ouvert

*=avec bague de serrage de réduction

d=tube outside diameter

Ad=outside diameter of cyl. stub

kv=flow factor (l/min)

L=installed length

H=valve opened

*=with reduced compression ferrule

Kegelrückschlagventil

Clapet anti-retour à siège conique

Taper seat non-return valve

SO CV 53B21
SOL CV 53B21

12

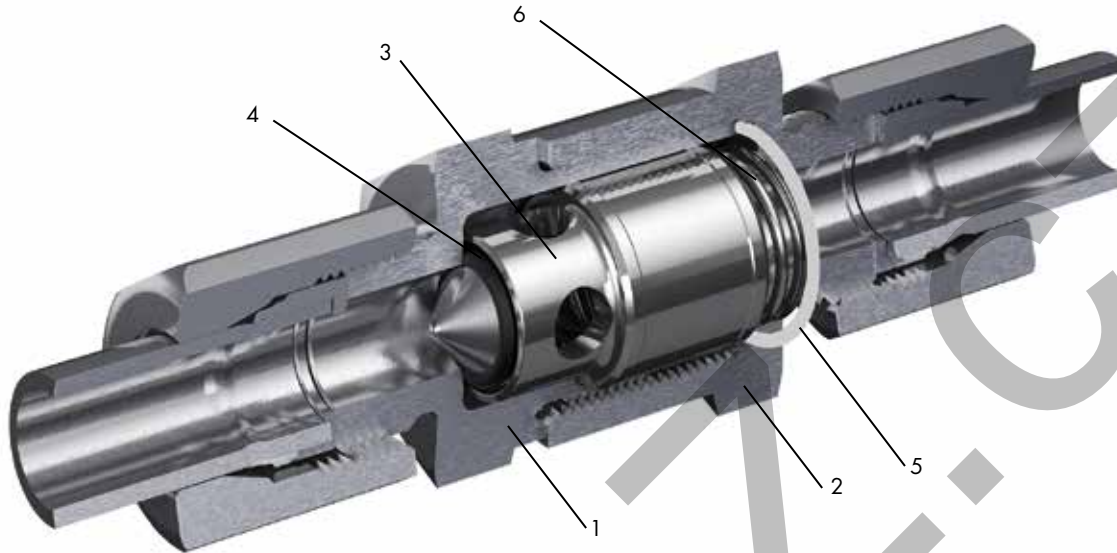

Nr. No. No.	Bezeichnung Désignation Description	Material Matériau Material	Nr. No. No.	Bezeichnung Désignation Description	Material Matériau Material	Nr. No. No.	Bezeichnung Désignation Description	Material Matériau Material
1	Ventilkegelführung Guidage cône du clapet Valve cone guide	1.4571	3	Ventilkegel Cône du clapet Valve cone	1.4571	5	Dichtscheibe Rondelle de joint Sealing washer	PTFE (FDA)
2	Ventilmutter Écrou du clapet Valve nut	1.4571	4*	Dichtung Joint Seal	FKM (FDA)	6*	Druckfeder Ressort de compression Compression spring	1.4401

Spezifikationen

Betriebsdruck (PN): 100 bis 200 bar
 Temperatur: -20°C bis +200°C
 Öffnungsdruck: 1 bar ± 20 %
 Sicherheitsfaktor: 1.5-fach

Merkmale

- Funktion: Rückflussverhinderer
- Einsatz: Luft, Öle und Flüssiggase (Beständigkeit Dichtung beachten)
- Material: Edelstahl 1.4571

* Optionen

- Nr. 4 - Dichtung: EPDM, FFKM
- Nr. 6 - Druckfeder: Öffnungsdruck 0.2, 0.5, 2, 3, 5 bar, ± 20 % (mind. ± 0.1 bar)
- Varianten: mit Übergangsmuffe SO 50030 oder Übergangsnippel SO 50040

Spécifications

Pression de service (PN): 100 à 200 bar
 Température: -20°C à +200°C
 Pression d'ouverture: 1 bar ± 20 %
 Facteur de sécurité: 1.5 fois

Caractéristiques

- Fonction: clapet anti-retour
- Application: air, huiles et gaz liquéfiés (tenir compte de la résistance de l'étanchéité)
- Matériau: acier inoxydable 1.4571

* Options

- No. 4 - Joint: EPDM, FFKM
- No. 6 - Ressort de compression: pression d'ouverture 0.2, 0.5, 2, 3, 5 bar, ± 20 % (min. ± 0.1 bar)
- Autres versions: avec adaptateur femelle SO 50030 ou mâle SO 50040

Specifications

Working pressure (PN): 100 to 200 bar
 Temperature: -20°C to +200°C
 Opening pressure: 1 bar ± 20 %
 Safety factor: 1.5 times

Characteristics

- Function: check valve
- Uses: air, oils and liquid gases (check resistance of seal)
- Material: stainless steel 1.4571

* Options

- No. 4 - Seal: EPDM, FFKM
- No. 6 - Compression spring: opening pressure 0.2, 0.5, 2, 3, 5 bar, ± 20 % (min. ± 0.1 bar)
- Other versions: with female SO 50030 or male adaptor SO 50040

Ventile Edelstahl Vannes acier inoxydable Valves stainless steel

Durchflussdiagramm

Der Druckabfall nimmt mit zunehmendem Durchfluss überproportional zu.

Courbe de débit

La perte de pression augmente disproportionnellement avec plus de débit.

Flow rate

The pressure drop increases disproportionately with increasing flow rate.

SO CV 53B21

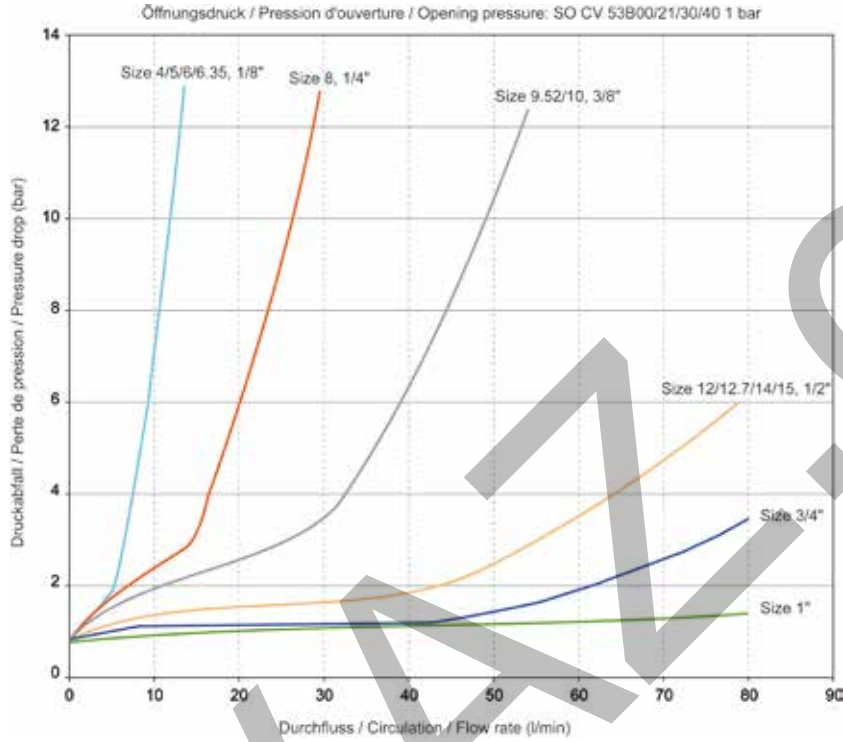

Öffnungsdruckdiagramm

Der Öffnungsdruck bewegt sich im blau skizzierten Bereich. Das Ventil schliesst im rot skizzierten Bereich.

Courbe de pression d'ouverture

La pression d'ouverture se trouve dans la zone indiquée en bleu. La vanne se ferme dans la zone indiquée en rouge.

Opening pressure diagram

The opening pressure ranges within the blue section. The valve closes within the red section.

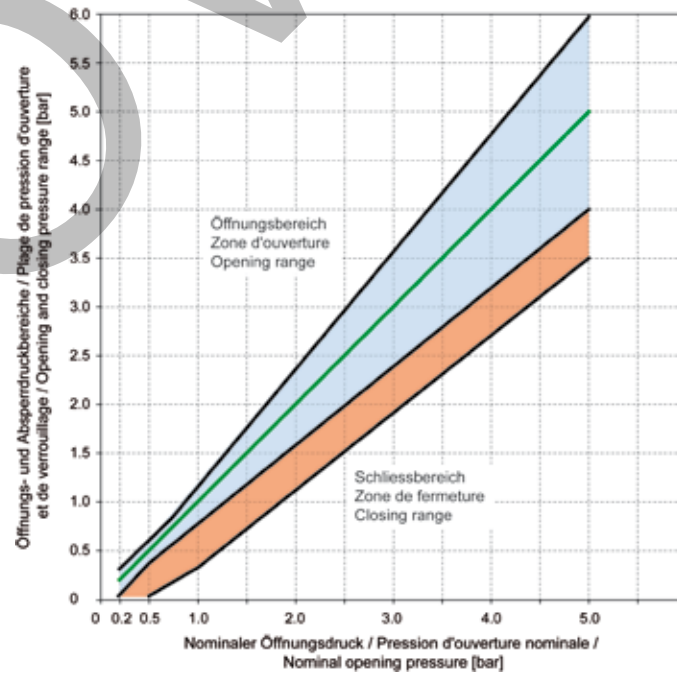

Sonderausführungen

siehe Kapitelübersicht

Exécutions en option

voir aperçu du chapitre

Optional services

see chapter overview

Kegelrückschlagventil

mit Innengewinde

Clapet anti-retour à siège conique

avec taraudage

Taper seat non-return valve

with female thread

SO CV 53B00

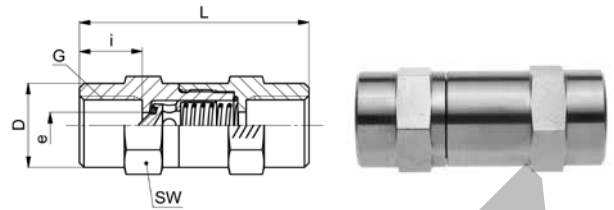

Type -G	Mat.-Nr.	bar	SW	L	D	i	e	kg/100
G=Rohrgewinde (zylindrisch)	G=Filetage-gaz BSP (cylindrique)		G=BSP thread (parallel)					
SO CV 53B00-1/8	068.3100.020	400	17	42.5	17.0	10.0	4.0	6.000
SO CV 53B00-1/4	068.3100.040	400	19	51.0	19.0	14.0	6.0	8.100
SO CV 53B00-3/8	068.3100.060	400	24	60.0	24.0	14.0	7.5	18.100
SO CV 53B00-1/2	068.3100.080	315	30	72.0	30.0	18.0	11.0	26.600
SO CV 53B00-3/4	068.3100.120	250	36	84.0	36.0	20.0	14.0	45.000
SO CV 53B00-1	068.3100.160	250	46	95.0	46.0	23.0	18.0	81.700

Kegelrückschlagventil

Clapet anti-retour à siège conique

Taper seat non-return valve

SO CV 53B21

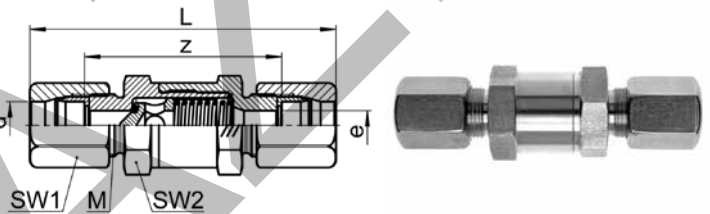

Type -d	Mat.-Nr.	bar	M	SW1	SW2	L	z	e	kg/100
Für metrische Rohre	Pour tubes métriques		For metric tubes						
* SO CV 53B21-4	068.3010.040	200	10x1.0	12	17	53.5	38.5	3.0	5.720
* SO CV 53B21-5	068.3010.050	200	10x1.0	12	17	53.5	38.5	3.8	5.600
SO CV 53B21-6	068.3010.060	200	10x1.0	12	17	53.5	38.5	3.8	5.520
SO CV 53B21-8	068.3010.080	200	12x1.0	14	19	60.5	44.0	5.8	7.960
SO CV 53B21-10	068.3010.100	160	14x1.0	17	22	73.5	51.0	7.5	15.140
SO CV 53B21-12	068.3010.120	100	16x1.0	19	22	75.5	51.0	7.5	27.420
* SO CV 53B21-14	068.3010.140	100	20x1.5	24	30	86.5	58.5	11.0	31.400
SO CV 53B21-15	068.3010.150	100	20x1.5	24	30	86.5	58.5	11.0	30.980
Für Zollrohre	Pour tubes pouces		For inch tubes						
SO CV 53B21-6,35	068.3010.063	200	10x1.0	12	17	53.5	38.5	3.8	5.460
SO CV 53B21-9,52	068.3010.095	160	14x1.0	17	22	73.5	51.0	7.5	15.240
* SO CV 53B21-12,7	068.3010.127	100	20x1.5	24	30	86.5	58.5	11.0	31.940

Umrechnung für "d" bei Zollrohren:

6,35 = 1/4

9,52 = 3/8

12,7 = 1/2

Conversion de "d" pour tubes en pouces:

6,35 = 1/4

9,52 = 3/8

12,7 = 1/2

Conversion for "d" for inch tubes:

6,35 = 1/4

9,52 = 3/8

12,7 = 1/2

d=Rohrassen-ø
 e=kleinste Bohrung
 L=Mass in montiertem Zustand
 *=mit reduziertem Klemmring

d=ø extérieur du tube
 e=ø-min. de passage
 L=après montage
 *=avec bague de serrage de réduction

d=tube outside diameter
 e=minimum bore
 L=installed length
 *=with reduced compression ferrule

Kegelrückschlagventil

mit Übergangsmuffe SO 50030

Clapet anti-retour à siège conique

avec adaptateur femelle SO 50030

Taper seat non-return valve

with female adaptor SO 50030

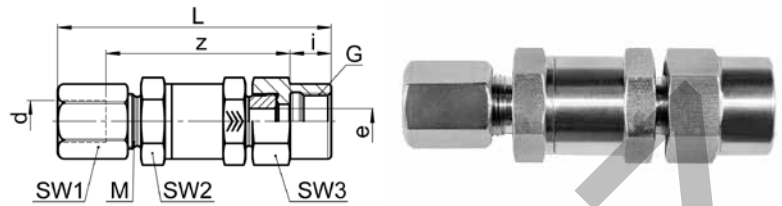

SO CV 53B30

Type - d - G	Mat.-Nr.	bar	M	SW1	SW2	SW3	L	i	z	e	kg/100	
Für metrische Rohre	Pour tubes métriques			For metric tubes								
G=Rohrgewinde (zylindrisch)	G=Filetage-gaz BSP (cylindrique)			G=BSP thread (parallel)								
* SO CV 53B30-4-1/8	068.3011.060	200	10x1.0	12	17	14	59.0	10.0	41.5	3.5	6.260	
* SO CV 53B30-5-1/8	068.3011.082	200	10x1.0	12	17	14	59.0	10.0	41.5	3.8	6.200	
SO CV 53B30-6-1/8	068.3011.100	200	10x1.0	12	17	14	59.0	10.0	41.5	3.8	6.160	
SO CV 53B30-6-1/4	068.3011.110	200	10x1.0	12	17	17	66.5	11.0	46.5	3.8	6.970	
SO CV 53B30-8-1/8	068.3011.160	200	12x1.0	14	19	17	65.0	10.0	46.5	5.8	9.390	
SO CV 53B30-8-1/4	068.3011.170	200	12x1.0	14	19	17	67.0	12.0	48.0	5.8	9.130	
SO CV 53B30-8-3/8	068.3011.180	160	12x1.0	14	19	22	67.0	11.0	46.5	5.8	11.230	
SO CV 53B30-10-1/4	068.3011.270	160	14x1.0	17	22	17	76.0	12.0	53.5	7.5	14.890	
SO CV 53B30-10-3/8	068.3011.280	160	14x1.0	17	22	22	77.0	12.0	53.5	7.5	17.170	
SO CV 53B30-12-1/2	068.3011.400	160	16x1.0	19	22	27	79.0	12.0	53.5	7.5	31.590	
* SO CV 53B30-14-1/2	068.3011.504	100	20x1.5	24	30	27	95.0	12.0	67.5	11.0	32.820	
SO CV 53B30-15-1/2	068.3011.534	100	20x1.5	24	30	27	90.0	12.0	62.5	11.0	32.610	
SO CV 53B30-15-3/4	068.3011.536	100	20x1.5	24	30	32	98.0	15.0	67.5	11.0	36.350	

Für Zollrohre

Pour tubes pouces

For inch tubes

SO CV 53B30-6,35-1/8	068.3011.135	200	10x1.0	12	17	14	59.0	10.0	41.5	3.8	6.130
SO CV 53B30-9,52-1/4	068.3011.230	160	14x1.0	17	22	17	76.0	12.0	53.5	7.5	14.940
SO CV 53B30-9,52-3/8	068.3011.235	160	14x1.0	17	22	22	77.0	12.0	53.5	7.5	17.220
SO CV 53B30-12,7-1/2	068.3011.434	100	20x1.5	24	30	27	90.0	12.0	62.5	11.0	33.090

Umrechnung für "d" bei Zollrohren:

6,35 = 1/4
 9,52 = 3/8
 12,7 = 1/2

Conversion de "d" pour tubes en pouces:

6,35 = 1/4
 9,52 = 3/8
 12,7 = 1/2

Conversion for "d" for inch tubes:

6,35 = 1/4
 9,52 = 3/8
 12,7 = 1/2

Montagehinweis: Nippel ist handfest montiert. Bei Endmontage mit 1/4 Umdrehung anziehen.

Wir empfehlen eine zusätzliche Schmierung auf der Planfläche.

Note d'installation: L'adaptateur femelle-mâle est monté serré à la main. Pour le montage final, serrer avec 1/4 de tour.

Nous recommandons une lubrification supplémentaire sur la surface plane.

Assembly information: Male adaptor is mounted finger-tight. For final assembly, tighten with 1/4 turn.

We recommend additional lubrication on the plane surface.

d=Rohraussen-ø
 e=kleinste Bohrung
 L=Mass in montiertem Zustand
 *=mit reduziertem Klemming

d=ø extérieur du tube
 e=ø-min. de passage
 L=après montage
 *=avec bague de serrage de réduction

d=tube outside diameter
 e=minimum bore
 L=installed length
 *=with reduced compression ferrule

Kegelrückschlagventil

mit Übergangsnippel SO 50040

Clapet anti-retour à siège conique

avec adaptateur mâle SO 50040

Taper seat non-return valve

with male adaptor SO 50040

SO CV 53B40

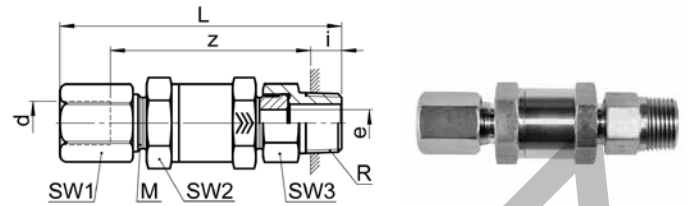

Type -d-R	Mat.-Nr.	bar	M	SW1	SW2	SW3	L	i	z	e	kg/100
Für metrische Rohre R=Rohrgewinde (kegelig)	Pour tubes métriques R=Filetage-gaz BSP (conique)			For metric tubes R=BSP thread (tapered)							
* SO CV 53B40-4-1/8	068.3012.060	200	10x1.0	12	17	12	56.0	5.0	43.0	3.5	5.500
* SO CV 53B40-4-1/4	068.3012.065	200	10x1.0	12	17	14	60.0	8.0	44.0	3.5	6.470
* SO CV 53B40-5-1/8	068.3012.082	200	10x1.0	12	17	12	56.0	5.0	43.0	3.8	5.440
* SO CV 53B40-5-1/4	068.3012.084	200	10x1.0	12	17	14	60.0	8.0	44.0	3.8	6.410
SO CV 53B40-6-1/8	068.3012.100	200	10x1.0	12	17	12	56.0	5.0	43.0	3.8	5.400
SO CV 53B40-6-1/4	068.3012.110	200	10x1.0	12	17	14	60.0	8.0	44.0	3.8	6.370
SO CV 53B40-8-1/8	068.3012.160	200	12x1.0	14	19	14	62.0	5.0	48.5	5.8	7.760
SO CV 53B40-8-1/4	068.3012.170	200	12x1.0	14	19	14	66.0	8.0	49.5	5.8	8.230
SO CV 53B40-8-3/8	068.3012.180	160	12x1.0	14	19	17	66.0	8.0	49.5	5.8	9.580
SO CV 53B40-8-1/2	068.3012.185	160	12x1.0	14	19	22	70.0	10.0	51.5	5.8	10.480
SO CV 53B40-10-1/4	068.3012.270	160	14x1.0	17	22	17	76.0	8.0	56.5	7.5	14.590
SO CV 53B40-10-3/8	068.3012.280	160	14x1.0	17	22	17	76.0	8.0	56.5	7.5	15.300
SO CV 53B40-10-1/2	068.3012.285	160	14x1.0	17	22	22	77.0	10.0	55.5	7.5	17.630
SO CV 53B40-12-1/2	068.3012.400	160	16x1.0	19	22	22	80.0	10.0	58.5	7.5	29.640
* SO CV 53B40-14-1/2	068.3012.504	100	20x1.5	24	30	24	95.0	10.0	67.5	11.0	30.420
SO CV 53B40-15-1/2	068.3012.534	100	20x1.5	24	30	24	90.0	10.0	67.5	11.0	30.210
SO CV 53B40-15-3/4	068.3012.536	100	20x1.5	24	30	27	90.5	9.5	66.5	11.0	31.560

Für Zollrohre

Pour tubes pouces

For inch tubes

SO CV 53B40-6,35-1/8	068.3012.135	200	10x1.0	12	17	12	56.0	5.0	38.5	3.8	5.370
SO CV 53B40-6,35-1/4	068.3012.140	200	10x1.0	12	17	14	60.0	8.0	38.5	3.8	6.340
SO CV 53B40-9,52-1/4	068.3012.230	160	14x1.0	17	22	17	76.0	8.0	51.0	7.5	14.640
SO CV 53B40-9,52-3/8	068.3012.235	160	14x1.0	17	22	17	76.0	8.0	51.0	7.5	15.350
SO CV 53B40-9,52-1/2	068.3012.240	160	14x1.0	17	22	22	77.0	10.0	51.0	7.5	17.680
SO CV 53B40-12,7-1/2	068.3012.434	100	20x1.5	24	30	24	90.0	10.0	58.5	11.0	30.690

Umrechnung für "d" bei Zollrohren:

 6,35 = 1/4
 9,52 = 3/8
 12,7 = 1/2

Conversion de "d" pour tubes en pouces:

 6,35 = 1/4
 9,52 = 3/8
 12,7 = 1/2

Conversion for "d" for inch tubes:

 6,35 = 1/4
 9,52 = 3/8
 12,7 = 1/2

Montagehinweis: Nippel ist handfest montiert. Bei Endmontage mit 1/4 Umdrehung anziehen.
Wir empfehlen eine zusätzliche Schmierung auf der Planfläche.

Note d'installation: L'adaptateur femelle-mâle est monté serré à la main. Pour le montage final, serrer avec 1/4 de tour.
Nous recommandons une lubrification supplémentaire sur la surface plane.

Assembly information: Male adaptor is mounted finger-tight. For final assembly, tighten with 1/4 turn.
We recommend additional lubrication on the plane surface.

 d=Rohrassen-ø
 e=kleinste Bohrung
 L=Mass in montiertem Zustand
 *=mit reduziertem Klemmring

 d=ø extérieur du tube
 e=ø-min. de passage
 L=après montage
 *=avec bague de serrage de réduction

 d=tube outside diameter
 e=minimum bore
 L=installed length
 *=with reduced compression ferrule

Kugelhahn

mit Innengewinde

Vanne à bille

avec taraudage

Ball valve

with female thread

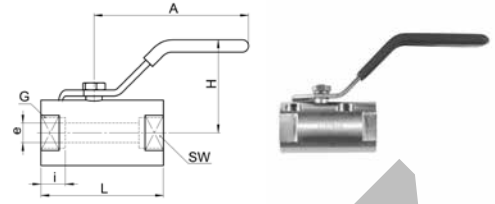

SO BV 58A00

Type -G	Mat.-Nr.	bar	SW	L	A	H	i	e	kv	kg/100
G=Rohrgewinde (zylindrisch)	G=Filetage-gaz BSP (cylindrique)	G=BSP thread (parallel)								
SO BV 58A00-1/4	068.8041.040	55	26	59.5	115.0	54.0	10.0	8.0	70.0	34.000
SO BV 58A00-3/8	068.8041.060	55	27	59.5	115.0	60.0	12.0	9.6	100.0	33.500
SO BV 58A00-1/2	068.8041.080	55	27	59.5	105.0	60.0	12.0	9.6	100.0	31.000
SO BV 58A00-3/4	068.8041.120	55	34	67.0	105.0	64.0	14.0	12.5	100.0	45.400
SO BV 58A00-1	068.8041.160	55	41	76.0	105.0	64.0	14.0	16.5	100.0	68.000

Spezifikationen

Betriebsdruck (PN): 55 bar
Sicherheitsfaktor: 1.5-fach
Temperatur: -40°C bis +200°C

Materialien

Ventilkörper, Kugel, Spindel: Edelstahl 1.4436 (AISI 316)
Griff: Edelstahl 1.4301 (AISI 304) mit PVC-Überzug
Dichtungen: PTFE

Dienstleistungsoptionen auf Anfrage

Spécifications

Pression de service (PN): 55 bar
Facteur de sécurité: 1.5 fois
Température: -40°C à +200°C

Matériaux

Corps, bille, pointeau: acier inoxydable 1.4436 (AISI 316)
Manette: acier inoxydable 1.4301 (AISI 304), couche en PVC
Joints: PTFE

Options de service sur demande

Specifications

Working pressure (PN): 55 bar
Safety factor: 1.5 times
Temperature: -40°C to +200°C

Materials

Valve body, ball, spindle: stainless steel 1.4436 (AISI 316)
Handle: stainless steel 1.4301 (AISI 304) with PVC cover
Seals: PTFE

Optional services on request

Sechskant Kugelhahn

mit Innengewinde

Vanne à bille hexagonale

avec taraudage

Hexagon ball valve

with female thread

12

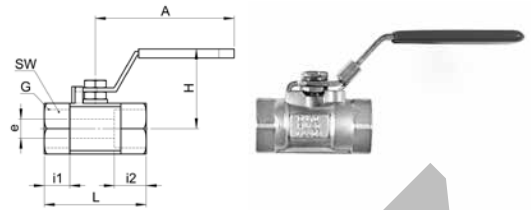

SO BV 58D00

Type -G	Mat.-Nr.	bar	SW	L	A	H	i1	i2	e	kg/100
G=Rohrgewinde (zylindrisch)	G=Filetage-gaz BSP (cylindrique)	G=BSP thread (parallel)								
SO BV 58D00-1/4	068.8061.040	90	28	58.5	102.0	46.0	14.0	15.5	9.2	32.000
SO BV 58D00-3/8	068.8061.060	90	28	58.5	102.0	46.0	15.0	15.0	9.2	32.000
SO BV 58D00-1/2	068.8061.080	90	28	66.0	97.0	54.0	20.0	17.5	9.2	27.500
SO BV 58D00-3/4	068.8061.120	90	34	70.0	98.0	56.0	21.0	19.0	12.5	36.000
SO BV 58D00-1	068.8061.160	90	39	80.0	104.0	63.0	24.0	20.0	15.5	63.000

Spezifikationen

Betriebsdruck (PN): 90 bar
 Sicherheitsfaktor: 1.5-fach
 Temperatur: -20°C bis +200°C

Materialien

Ventilkörper, Kugel, Spindel: Edelstahl 1.4408
 Griff: Edelstahl 1.4301 (AISI 304) mit PVC-Überzug
 Dichtungen: PTFE

Dienstleistungsoptionen auf Anfrage

Spécifications

Pression de service (PN): 90 bar
 Facteur de sécurité: 1.5 fois
 Température: -20°C à +200°C

Matériaux

Corps, bille, pointeau: acier inoxydable 1.4408
 Manette: acier inoxydable 1.4301 (AISI 304), couche en PVC
 Joints: PTFE

Options de service sur demande

Specifications

Working pressure (PN): 90 bar
 Safety factor: 1.5 times
 Temperature: -20°C to +200°C

Materials

Valve body, ball, spindle: stainless steel 1.4408
 Handle: stainless steel 1.4301 (AISI 304) with PVC cover
 Seals: PTFE

Optional services on request

Kugelhahn

Vanne à bille

Ball valve

SO BV 58D21

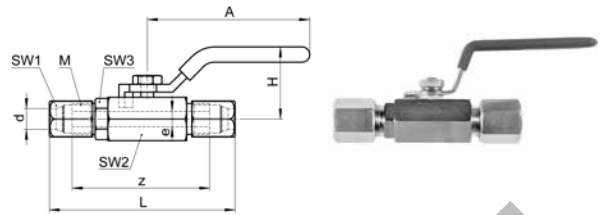

Type -d	Mat.-Nr.	bar	M	SW1	SW2	SW3	L	A	H	z	e	kv	kg/100
* SO BV 58D21-6	068.8000.060	64	12x1.0	14	17	14	72.0	62.0	30.0	55.5	4.5	30.0	5.800
SO BV 58D21-8	068.8000.080	64	12x1.0	14	17	14	72.0	62.0	30.0	54.0	5.0	30.0	11.200
* SO BV 58D21-10	068.8000.100	64	16x1.0	19	21	17	85.0	85.0	40.0	60.0	7.5	60.0	10.000
SO BV 58D21-12	068.8000.120	64	16x1.0	19	21	17	85.0	85.0	40.0	60.0	7.5	60.0	9.800

Kompakter Kugelhahn für die Verwendung in Heizungs-, Industrie- und Chemieanlagen.

Spezifikationen

Betriebsdruck: 64 bar
Sicherheitsfaktor: 1.5-fach
Temperatur: -40°C bis +180°C

Materialien

Ventilkörper, Kugel, Spindel: Edelstahl 1.4436 (AISI 316)
Griff: Edelstahl 1.4301 (AISI 304) mit PVC-Überzug
Dichtungen: PTFE
Rohranschlüsse: Edelstahl 1.4571 (≈ AISI 316 Ti)

Dienstleistungsoptionen auf Anfrage

Vanne à bille compact pour les applications générales dans les installations de chauffage, de l'industrie et de la chimie.

Spécifications

Pression de service: 64 bar
Facteur de sécurité: 1.5 fois
Température: -40°C à +180°C

Matériaux

Corps, bille, poignée: acier inoxydable 1.4436 (AISI 316)
Manette: acier inoxydable 1.4301 (AISI 304) avec couche en PVC
Joints: PTFE
Raccordement: acier inoxydable 1.4571 (≈ AISI 316 Ti)

Options de service sur demande

Compact ball valve for general application in heating, industry and chemical installations.

Specifications

Working pressure: 64 bar
Safety factor: 1.5 times
Temperature: -40°C to +180°C

Materials

Valve body, ball, spindle: stainless steel 1.4436 (AISI 316)
Handle: stainless steel 1.4301 (AISI 304) with PVC cover
Seals: PTFE
Tube connections: stainless steel 1.4571 (≈ AISI 316 Ti)

Optional services on request

d=Rohrassen-ø
e=kleinste Bohrung
kv=Kenngröße für das Durchflussverhalten (l/min)
L=Mass in montiertem Zustand
*=mit reduziertem Klemmring

d=ø extérieur du tube
e=ø-min. de passage
kv=facteur d'écoulement (l/min)
L=après montage
*=avec bague de serrage de réduction

d=tube outside diameter
e=minimum bore
kv=flow factor (l/min)
L=installed length
*=with reduced compression ferrule

Kugelhahn

mit Übergangsmuffe SO 50030

Vanne à bille

avec adaptateur femelle SO 50030

Ball valve

with female adaptor SO 50030

SO BV 58D30

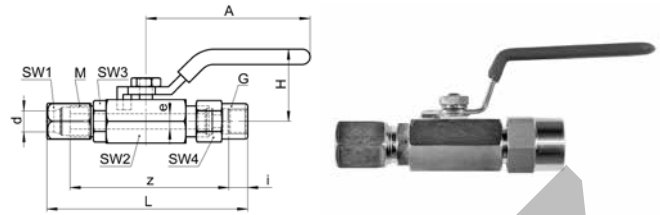

Type -d-G	Mat.-Nr.	bar	M	SW1	SW2	SW3	SW4	L	A	H	i	z	e	kv	kg/100
G=Rohrgewinde (zylindrisch)															

Kompakter Kugelhahn für die Verwendung in Heizungs-, Industrie- und Chemieanlagen.

Spezifikationen

Betriebsdruck: 64 bar
Sicherheitsfaktor: 1.5-fach
Temperatur: -40°C bis +180°C

Materialien

Ventilkörper, Kugel, Spindel: Edelstahl 1.4436 (AISI 316)
Griff: Edelstahl 1.4301 (AISI 304) mit PVC-Überzug
Dichtungen: PTFE
Rohranschlüsse: Edelstahl 1.4571 (≈ AISI 316 Ti)

Dienstleistungsoptionen auf Anfrage

Montagehinweis: Nippel ist handfest montiert. Bei Endmontage mit 1/4 Umdrehung anziehen.
Wir empfehlen eine zusätzliche Schmierung auf der Planfläche.

Vanne à bille compact pour les applications générales dans les installations de chauffage, de l'industrie et de la chimie.

Spécifications

Pression de service: 64 bar
Facteur de sécurité: 1.5 fois
Température: -40°C à +180°C

Matériaux

Corps, bille, pointeau: acier inoxydable 1.4436 (AISI 316)
Manette: acier inoxydable 1.4301 (AISI 304) avec couche en PVC
Joints: PTFE
Raccordement: acier inoxydable 1.4571 (≈ AISI 316 Ti)

Options de service sur demande

Note d'installation: L'adaptateur femelle-mâle est monté serré à la main. Pour le montage final, serrer avec 1/4 de tour.
Nous recommandons une lubrification supplémentaire sur la surface plane.

Compact ball valve for general application in heating, industry and chemical installations.

Specifications

Working pressure: 64 bar
Safety factor: 1.5 times
Temperature: -40°C to +180°C

Materials

Valve body, ball, spindle: stainless steel 1.4436 (AISI 316)
Handle: stainless steel 1.4301 (AISI 304) with PVC cover
Seals: PTFE
Tube connections: stainless steel 1.4571 (≈ AISI 316 Ti)

Optional services on request

Assembly information: Male adaptor is mounted finger-tight. For final assembly, tighten with 1/4 turn.
We recommend additional lubrication on the plane surface.

d=Rohrussen-ø
e=kleinste Bohrung
kv=Kenngröße für das Durchflussverhalten (l/min)
L=Mass in montiertem Zustand
*=mit reduziertem Klemmring

d=ø extérieur du tube
e=ø-min. de passage
kv=facteur d'écoulement (l/min)
L=après montage
*=avec bague de serrage de réduction

d=tube outside diameter
e=minimum bore
kv=flow factor (l/min)
L=installed length
*=with reduced compression ferrule

Kugelhahn

mit Übergangsnippel SO 50040

Vanne à bille

avec adaptateur mâle SO 50040

Ball valve

with male adaptor SO 50040

SO BV 58D40

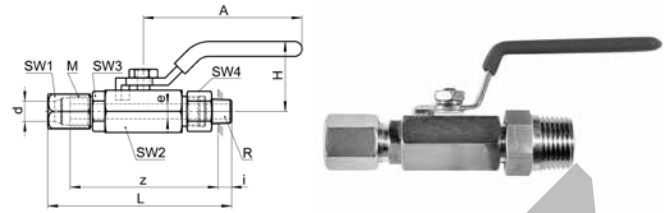

Type -d-R	Mat.-Nr.	bar	M	SW1	SW2	SW3	SW4	L	A	H	z	e	kv	kg/100	
R=Rohrgewinde (kegelig)				R=Filetage-gaz BSP (conique)											
				R=BSP thread (tapered)											
* SO BV 58D40-6-1/8	068.8401.100	64	12x1.0	14	17	14	14	73.0	62.0	30.0	58.0	4.5	30.0	5.600	
* SO BV 58D40-6-1/4	068.8401.110	64	12x1.0	14	17	14	14	77.0	62.0	30.0	59.0	4.5	30.0	6.000	
SO BV 58D40-8-1/8	068.8401.160	64	12x1.0	14	17	14	14	73.0	62.0	30.0	57.5	5.0	30.0	5.500	
SO BV 58D40-8-1/4	068.8401.170	64	12x1.0	14	17	14	14	77.5	62.0	30.0	58.5	5.0	30.0	6.000	
* SO BV 58D40-10-1/4	068.8401.270	64	16x1.0	19	21	17	19	87.0	85.0	40.0	64.5	7.5	60.0	9.600	
* SO BV 58D40-10-3/8	068.8401.280	64	16x1.0	19	21	17	19	85.5	85.0	40.0	63.0	7.5	60.0	9.800	
* SO BV 58D40-10-1/2	068.8401.285	64	16x1.0	19	21	17	22	89.5	85.0	40.0	64.0	7.5	60.0	12.500	
SO BV 58D40-12-1/4	068.8401.380	64	16x1.0	19	21	17	19	87.0	85.0	40.0	64.5	7.5	60.0	9.600	
SO BV 58D40-12-3/8	068.8401.390	64	16x1.0	19	21	17	19	87.5	85.0	40.0	65.0	7.5	60.0	9.800	
SO BV 58D40-12-1/2	068.8401.400	64	16x1.0	19	21	17	22	89.5	85.0	40.0	64.0	7.5	60.0	12.500	

Kompakter Kugelhahn für die Verwendung in Heizungs-, Industrie- und Chemieanlagen.

Spezifikationen

Betriebsdruck: 64 bar
Sicherheitsfaktor: 1.5-fach
Temperatur: -40°C bis +180°C

Materialien

Ventilkörper, Kugel, Spindel: Edelstahl 1.4436 (AISI 316)
Griff: Edelstahl 1.4301 (AISI 304) mit PVC-Überzug
Dichtungen: PTFE
Rohranschlüsse: Edelstahl 1.4571 (≈ AISI 316 Ti)

Dienstleistungsoptionen auf Anfrage

Montagehinweis: Nippel ist handfest montiert. Bei Endmontage mit 1/4 Umdrehung anziehen.

Wir empfehlen eine zusätzliche Schmierung auf der Planfläche.

Dienstleistungsoptionen auf Anfrage.

Vanne à bille compact pour les applications générales dans les installations de chauffage, de l'industrie et de la chimie.

Spécifications

Pression de service: 64 bar
Facteur de sécurité: 1.5 fois
Température: -40°C à +180°C

Matériaux

Corps, bille, pointeau: acier inoxydable 1.4436 (AISI 316)
Manette: acier inoxydable 1.4301 (AISI 304) avec couche en PVC
Joints: PTFE
Raccordement: acier inoxydable 1.4571 (≈ AISI 316 Ti)

Options de service sur demande

Note d'installation: L'adaptateur femelle-mâle est monté serré à la main. Pour le montage final, serrer avec 1/4 de tour.

Nous recommandons une lubrification supplémentaire sur la surface plane.

Options de service sur demande.

Compact ball valve for general application in heating, industry and chemical installations.

Specifications

Working pressure: 64 bar
Safety factor: 1.5 times
Temperature: -40°C to +180°C

Materials

Valve body, ball, spindle: stainless steel 1.4436 (AISI 316)
Handle: stainless steel 1.4301 (AISI 304) with PVC cover
Seals: PTFE
Tube connections: stainless steel 1.4571 (≈ AISI 316 Ti)

Optional services on request

Assembly information: Male adaptor is mounted finger-tight. For final assembly, tighten with 1/4 turn.

We recommend additional lubrication on the plane surface.

Optional services on request.

d=Rohrassen-ø
e=kleinste Bohrung
kv=Kenngröße für das Durchflussverhalten (l/min)
L=Mass in montiertem Zustand
*=mit reduziertem Klemmring

d=ø extérieur du tube
e=ø-min. de passage
kv=facteur d'écoulement (l/min)
L=après montage
*=avec bague de serrage de réduction

d=tube outside diameter
e=minimum bore
kv=flow factor (l/min)
L=installed length
*=with reduced compression ferrule

Nadelventil

mit Innengewinde

Vanne à poiteau

avec taraudage

Needle valve

with female thread

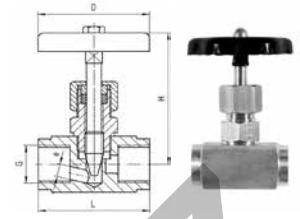
SO NV 51B00

Type -G	Mat.-Nr.	bar	L	D	H	e	kv	kg/100
G=Rohrgewinde (zylindrisch)	G=Filetage-gaz BSP (cylindrique)	G=BSP thread (parallel)						
SO NV 51B00- $\frac{3}{8}$	068.1010.060	200	55.0	60.0	93.0	6.0	10.0	32.000
SO NV 51B00- $\frac{1}{2}$	068.1010.080	200	60.0	60.0	96.0	7.0	12.0	41.500
SO NV 51B00- $\frac{3}{4}$	068.1010.120	200	75.0	70.0	117.0	8.0	29.0	75.300
SO NV 51B00-1	068.1010.160	200	100.0	90.0	138.0	12.0	32.0	154.000

Spezifikationen

Betriebsdruck: 200 bar
 Sicherheitsfaktor: 1.5-fach
 Temperatur: -40°C bis +200°C

Materialien

Ventilkörper, Spindel: Edelstahl 1.4571 (\approx AISI 316 Ti)
 Handrad: Stahlblech lackiert
 Stopfbuchse: PTFE

Dienstleistungsoptionen auf Anfrage

Spécifications

Pression de service: 200 bar
 Facteur de sécurité: 1.5 fois
 Température: -40°C à +200°C

Matériaux

Corps, poiteau: acier inoxydable 1.4571 (\approx AISI 316 Ti)
 Volant: acier laqué
 Presse-étoupe: PTFE

Options de service sur demande

Specifications

Working pressure: 200 bar
 Safety factor: 1.5 times
 Temperature: -40°C to +200°C

Materials

Valve body, spindle: stainless steel 1.4571 (\approx AISI 316 Ti)
 Handwheel: lacquered sheet metal
 Seals: PTFE

Optional services on request

Nadelventil

Vanne à poiteau

Needle valve

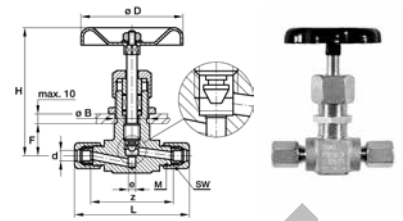

SO NV 51B21

Type -d	Mat.-Nr.	bar	M	SW	L	B	D	F	H	z	e	kv	kg/100
Für metrische Rohre	Pour tubes métriques	For metric tubes											
* SO NV 51B21-4	068.1500.040	160	10x1.0	12	72.0	22.5	70.0	19.0	88.0	57.0	4.0	3.5	42.000
* SO NV 51B21-5	068.1500.050	160	10x1.0	12	72.0	22.5	70.0	19.0	88.0	57.0	4.0	3.5	42.000
SO NV 51B21-6	068.1500.060	160	10x1.0	12	72.0	22.5	70.0	19.0	88.0	57.0	4.0	4.0	42.000
SO NV 51B21-8	068.1500.080	160	12x1.0	14	76.0	22.5	70.0	19.0	88.0	60.0	6.0	7.1	44.000
SO NV 51B21-10	068.1500.100	160	14x1.0	17	80.0	22.5	70.0	19.0	88.0	60.0	6.0	7.5	46.000
SO NV 51B21-12	068.1500.120	160	16x1.0	19	82.0	22.5	70.0	19.0	88.0	57.0	6.0	8.5	47.000
SO NV 51B21-15	068.1500.150	100	20x1.5	24	89.0	22.5	70.0	19.0	88.0	62.0	6.0	8.5	50.000
Für Zollrohre	Pour tubes pouces	For inch tubes											
SO NV 51B21-6,35	068.1500.063	160	10x1.0	12	72.0	22.5	70.0	19.0	88.0	57.0	4.0	4.0	42.000
SO NV 51B21-9,52	068.1500.095	160	14x1.0	17	80.0	22.5	70.0	19.0	88.0	60.0	6.0	7.5	46.000

Umrechnung für "d" bei Zollrohren:
 6,35 = 1/4
 9,52 = 3/8

Conversion de "d" pour tubes en pouces:
 6,35 = 1/4
 9,52 = 3/8

Conversion for "d" for inch tubes:
 6,35 = 1/4
 9,52 = 3/8

Spezifikationen

Betriebsdruck: 160 bar
 Sicherheitsfaktor: 1.5-fach
 Temperatur: -40°C bis +200°C

Spécifications

Pression de service: 160 bar
 Facteur de sécurité: 1.5 fois
 Température: -40°C à +200°C

Specifications

Working pressure: 160 bar
 Safety factor: 1.5 times
 Temperature: -40°C to +200°C

Materialien

Ventilkörper, Spindel, Mutter: Edelstahl 1.4571
 (≈ AISI 316 Ti)
 Kontermutter: Edelstahl 1.4301 (AISI 304)
 Handrad: Stahlblech lackiert
 Stopfbuchse: PTFE

Matériaux

Corps, poiteau, écrou: acier inoxydable
 1.4571 (≈ AISI 316 Ti)
 Contre-écrou: acier inoxydable 1.4301 (AISI
 304)
 Volant: acier laqué
 Presse-étoupe: PTFE

Materials

Valve body, spindle, nut: stainless steel 1.4571
 (≈ AISI 316 Ti)
 Counter-nut: stainless steel 1.4301 (AISI 304)
 Handwheel: lacquered sheet metal
 Seals: PTFE

Dienstleistungsoptionen auf Anfrage

Options de service sur demande

Optional services on request

d=Rohrassen-ø
 e=kleinste Bohrung
 kv=Kenngröße für das Durchflussverhalten (l/min)
 L=Mass in montiertem Zustand
 H=Ventil geöffnet
 *=mit reduziertem Klemmring

d=ø extérieur du tube
 e=ø-min. de passage
 kv=facteur d'écoulement (l/min)
 L=après montage
 H=vanne ouvert
 *=avec bague de serrage de réduction

d=tube outside diameter
 e=minimum bore
 kv=flow factor (l/min)
 L=installed length
 H=valve opened
 *=with reduced compression ferrule

2-Weg Hochdruckkugelhahn

Vanne à bille droite pour haute pression

2-way high pressure ball valve

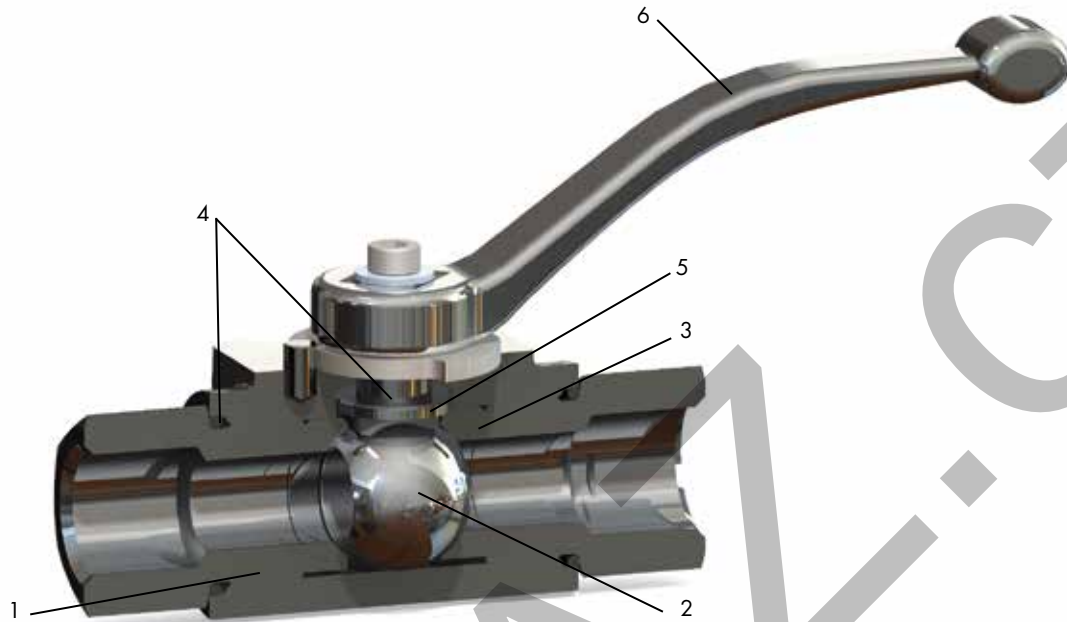
HKM-G
SOL BV 58A21
12

Nr. No. No.	Bezeichnung Désignation Description	Material Matériau Material	Nr. No. No.	Bezeichnung Désignation Description	Material Matériau Material	Nr. No. No.	Bezeichnung Désignation Description	Material Matériau Material
1	Ventilkörper Corps de vanne Valve body	1.4571	3*	Dichtschale Enveloppe d'étanchéité Sealing bush	POM	5	Spindelflachdichtung Joint plat de pointeau Stem sealing	PTFE
2	Kugel Bille Ball	1.4571	4	Dichtung Joint Seal	FKM	6	Hebel Levier Handle	Druckguss Fonte inj. Die casting

Spezifikationen

Betriebsdruck (PN): 400 bar
 Temperatur: -40°C bis +180°C
 Sicherheitsfaktor: 1.1-fach

Merkmale

- Funktion: Absperrhahn
- Einsatz: durch die Verwendung von rost- und säurebeständigen Edelstählen grösste Einsatzmöglichkeit in allen Industrien
- Besonderes: durch Vollstromquerschnitte keine Druckverluste; leichte Schaltbarkeit auch unter hohem Druck; durch auswechselbare Dichtungen lange Lebensdauer

* Optionen

- Nr. 3 - Dichtschale: PEEK

Spécifications

Pression de service (PN): 400 bar
 Température: -40°C à +180°C
 Facteur de sécurité: 1.1 fois

Caractéristiques

- Fonction : vanne d'arrêt
- Utilisation: grâce à l'emploi d'aciers inoxydables résistants à la rouille et aux acides conçu pour un maximum d'applications dans tous les secteurs
- Particularité: pas de pertes de pression grâce au passage intégral ; manœuvre facile même sous pression; longue durée de vie du produit grâce à la possibilité de changer les joints

* Options

- No. 3 - Enveloppe d'étanchéité: PEEK

Specifications

Working pressure (PN): 400 bar
 Temperature: -40°C to +180°C
 Safety factor: 1.1 times

Characteristics

- Function: shut-off valve
- Uses: large range of industrial applications due to use of corrosion and acid-resistant stainless steels
- Special features: no pressure loss due to full-flow cross-sections; easy switching even under high pressure; long service life thanks to replaceable seals

* Options

- No. 3 - Sealing bush: PEEK

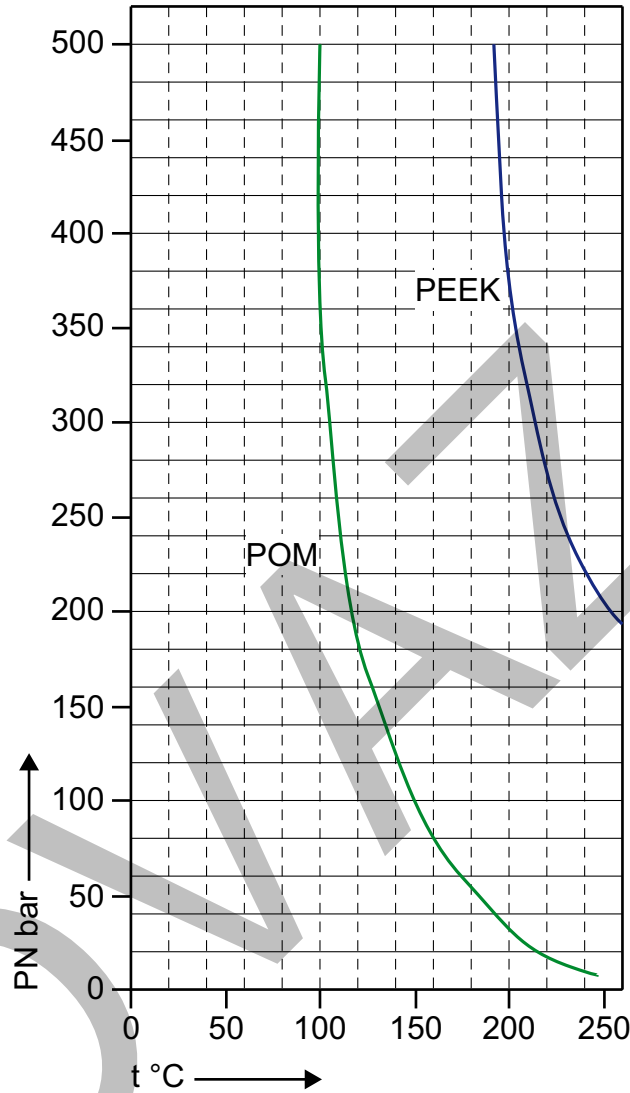

Achtung

Hochdruckkugelhähne, die mit Dichtschalen aus PEEK geliefert werden sollen, müssen bei der Bestellung klar mit "PEEK" nach der Materialnummer gekennzeichnet werden.

Attention

Robinets, qui doivent être fournis avec douille d'étanchéité en PEEK sont à référencer dans la commande avec la mention "PEEK" après le numéro de référence.

Attention

High pressure ball valves which are to be supplied with sealing bush in PEEK must be clearly identifiable in the order with the extension "PEEK" after the material number.

Hochdruck-Kugelhähne

beidseitig Innengewinde nach ISO 228/1

Robinetts à boisseaux sphériques haute pression

filetage femelle de chaque côté selon la norme ISO 228/1

High pressure ball valves

double-sided female thread to ISO 228/1

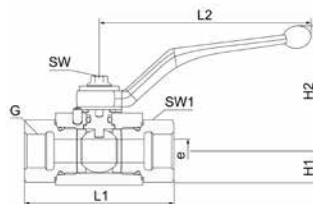

HKM-G

Type -G	Mat.-Nr.	PN	G	SW	SW1	L1	L2	H1	H2	e	g/Stk	
G=Rohrgewinde (zylindrisch)		G=Filetage-gaz BSP (cylindrique)				G=BSP thread (parallel)						
HKM-G 1.8	808.8100.020	500	1/8	9	22	69.0	115.0	13.5	71.5	5.0	410	
HKM-G 1.4	808.8100.040	500	1/4	9	22	69.0	115.0	13.5	71.5	6.0	400	
HKM-G 3.8	808.8100.060	500	3/8	9	27	72.0	115.0	17.5	72.5	10.0	540	
HKM-G 1.2	808.8100.080	500	1/2	9	30	83.0	115.0	19.0	73.0	13.0	650	
HKM-G 3.4	808.8100.120	350	3/4	14	41	95.0	160.0	24.5	86.5	20.0	1500	
HKM-G 1.1	808.8100.160	350	1	14	50	113.0	160.0	29.5	89.5	25.0	2200	

Dienstleistungsoptionen auf Anfrage

Options de service sur demande

Optional services on request

Hochdruck-Kugelhahn SOL

Vanne à bille SOL haute pression

High pressure ball valve SOL

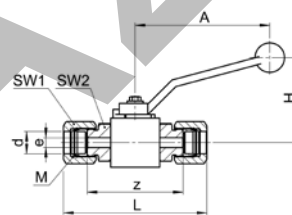

SOL BV 58A21

Type -d	Mat.-Nr.	bar	M	SW1	SW2	L	A	H	z	e	kv	kg/100
SOL BV 58A21-6	088.8102.060	400	10x1.0	14	22	94.5	115.0	82.0	74.5	4.5	30.0	43.300
SOL BV 58A21-8	088.8102.080	330	12x1.0	17	22	97.5	115.0	82.0	76.5	6.0	30.0	45.000
SOL BV 58A21-10	088.8102.100	330	14x1.0	19	22	101.5	115.0	82.0	76.5	6.0	60.0	46.500
SOL BV 58A21-12	088.8102.120	330	16x1.0	22	22	103.5	115.0	82.0	76.5	6.0	60.0	49.200
SOL BV 58A21-15	088.8102.150	250	20x1.5	27	27	115.5	115.0	86.0	85.5	10.0	60.0	69.700
SOL BV 58A21-16	088.8102.160	200	24x1.5	30	27	122.8	115.0	86.0	85.5	10.0	60.0	74.800
SOL BV 58A21-18	088.8102.180	200	24x1.5	30	27	120.0	115.0	86.0	85.8	10.0	60.0	73.000

Dienstleistungsoptionen auf Anfrage

Options de service sur demande

Optional services on request

d=Rohraussen- \varnothing
e=kleinste Bohrung
kv=Kenngröße für das Durchflussverhalten (l/min)
L=Mass in montiertem Zustand

d= \varnothing extérieur du tube
e= \varnothing -min. de passage
kv=facteur d'écoulement (l/min)
L=après montage

d=tube outside diameter
e=minimum bore
kv=flow factor (l/min)
L=installed length

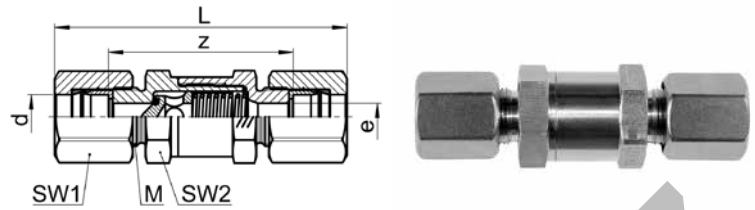
Kegelrückschlagventil
Clapet anti-retour à siège conique
Taper seat non-return valve
SOL CV 53B21

Type -d	Mat.-Nr.	bar	M	SW1	SW2	L	z	e	kg/100
Für metrische Rohre	Pour tubes métriques			For metric tubes					
SOL CV 53B21-6	088.3010.060	400	10x1.0	14	17	58.5	38.5	3.8	6.900
SOL CV 53B21-8	088.3010.080	330	12x1.0	17	19	64.5	44.0	5.8	10.000
SOL CV 53B21-10	088.3010.100	330	14x1.0	19	22	76.0	51.0	7.5	15.000
SOL CV 53B21-12	088.3010.120	330	16x1.0	22	22	76.0	51.0	7.5	15.000
SOL CV 53B21-15	088.3010.150	250	20x1.5	27	30	89.0	58.5	11.0	32.000

Für Zollrohre	Pour tubes pouces			For inch tubes					
SOL CV 53B21-6,35	088.3010.063	400	10x1.0	14	17	58.5	38.5	3.8	6.900
SOL CV 53B21-9,52	088.3010.095	330	14x1.0	19	22	64.5	51.0	7.5	15.000
SOL CV 53B21-12,7	088.3010.127	250	20x1.5	27	30	89.0	58.5	11.0	31.000

Umrechnung für "d" bei Zollrohren:

6,35 = 1/4

9,52 = 3/8

12,7 = 1/2

Conversion de "d" pour tubes en pouces:

6,35 = 1/4

9,52 = 3/8

12,7 = 1/2

Conversion for "d" for inch tubes:

6,35 = 1/4

9,52 = 3/8

12,7 = 1/2

Technische Informationen und Diagramme siehe SO CV 53B21

Informations techniques et diagrammes voir SO CV 53B21

Technical information and diagrams see SO CV 53B21

Kegelrückschlagventil
Clapet anti-retour à siège conique
Taper seat non-return valve

SO 6611
SO 6613

12

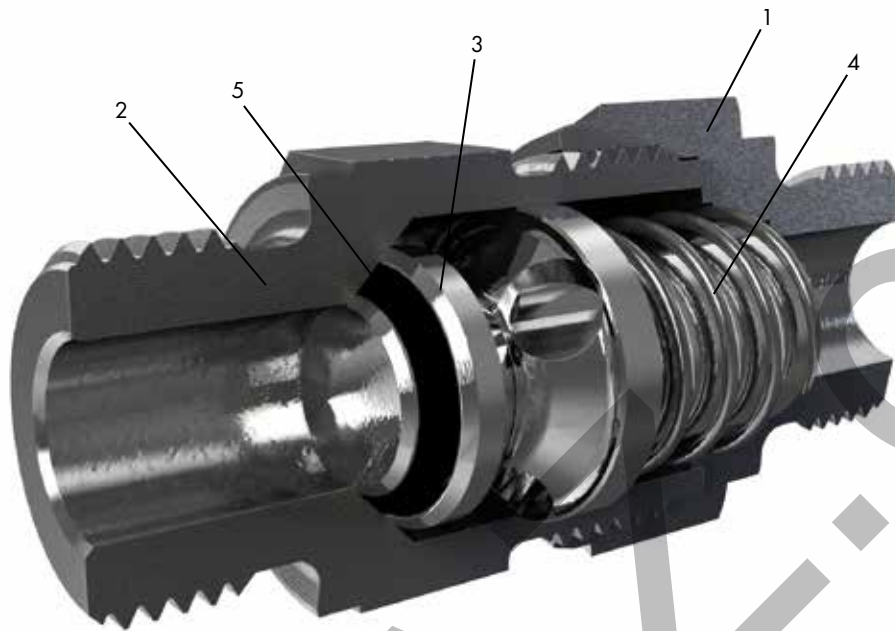

Nr. No. No.	Bezeichnung Désignation Description	Material Matériau Material	Nr. No. No.	Bezeichnung Désignation Description	Material Matériau Material	Nr. No. No.	Bezeichnung Désignation Description	Material Matériau Material
1	Ventilmutter Écrou du clapet Valve nut	1.0718	3	Ventilkegel Cône du clapet Valve cone	1.0718	5*	Dichtung Joint Seal	NBR
2	Ventilkegelführung Guidage cône du clapet Valve cone guide	1.0718	4*	Druckfeder Ressort de compression Compression spring	1.1200 DH			

Spezifikationen

Betriebsdruck (PN): 160 bis 250 bar
 Temperatur: -20°C bis +80°C
 Öffnungsdruck: 1 bar ± 20 %
 Sicherheitsfaktor: 1.5-fach

Merkmale

- Funktion: Rückflussverhinderer

*** Optionen**

- Nr. 4 - Druckfeder: optionale Öffnungsdrücke auf Anfrage
- Nr. 5 - Dichtung: EPDM, FKM

Spécifications

Pression de service (PN): 160 à 250 bar
 Température: -20°C à +80°C
 Pression d'ouverture: 1 bar ± 20 %
 Facteur de sécurité: 1.5 fois

Caractéristiques

- Fonction: clapet anti-retour

*** Options**

- No. 4 - Ressort de compression: autre pression d'ouverture sur demande
- No. 5 - Joint: EPDM, FKM

Specifications

Working pressure (PN): 160 to 250 bar
 Temperature: -20°C to +80°C
 Opening pressure: 1 bar ± 20 %
 Safety factor: 1.5 times

Characteristics

- Function: check valve

*** Options**

- No. 4 - Compression spring: other opening pressures on request
- No. 5 - Seal: EPDM, FKM

Durchflussdiagramm

Der Druckabfall nimmt mit zunehmendem Durchfluss überproportional zu.

Courbe de débit

La perte de pression augmente disproportionnellement avec plus de débit.

Flow rate

The pressure drop increases disproportionately with increasing flow rate.

SO 6611

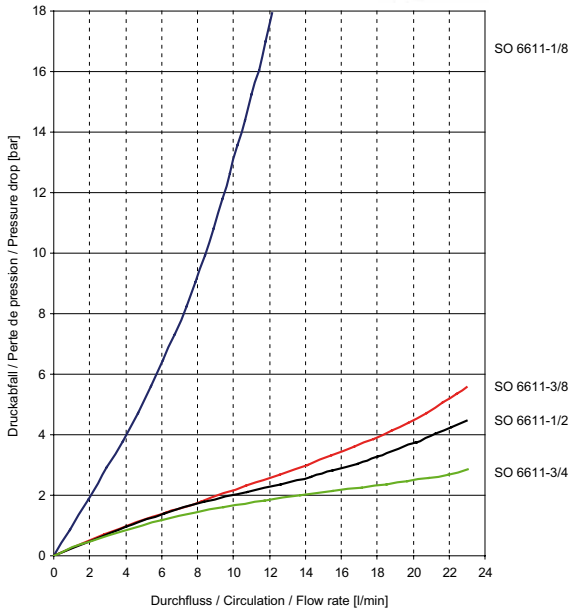

SO 6613

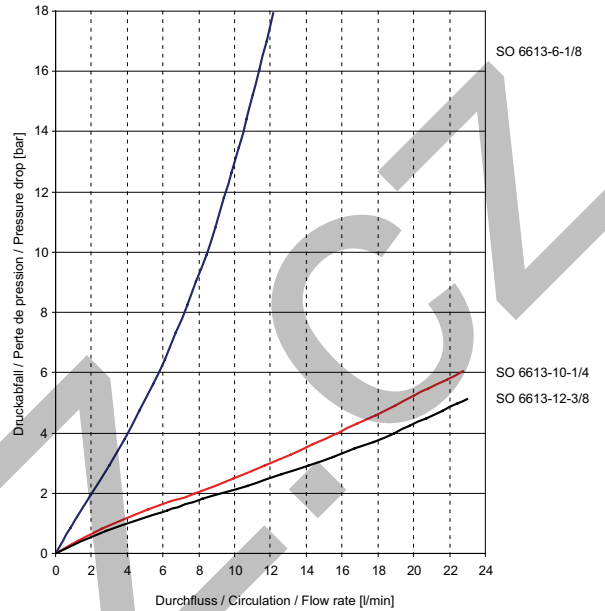

Öffnungsdruckdiagramm

Der Öffnungsdruck bewegt sich im blau skizzierten Bereich. Das Ventil schliesst im rot skizzierten Bereich.

Courbe de pression d'ouverture

La pression d'ouverture se trouve dans la zone indiquée en bleu. La vanne se ferme dans la zone indiquée en rouge.

Opening pressure diagram

The opening pressure ranges within the blue section. The valve closes within the red section.

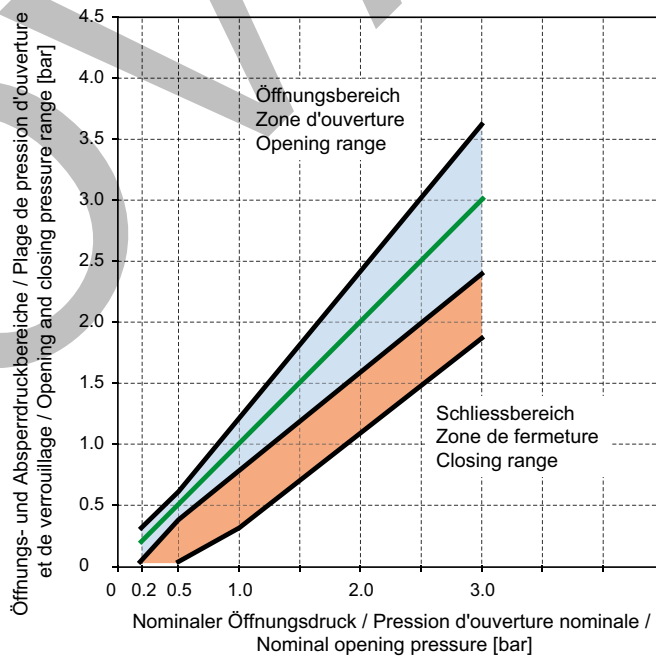

Sonderausführungen

siehe Kapitelübersicht

Exécutions en option

voir aperçu du chapitre

Optional services

see chapter overview

Kegelrückschlagventil

beidseitig mit Einschraubgewinde

Clapet anti-retour à siège conique

avec filetage des deux côtés

Taper seat non-return valve

with male adaptor thread at both ends

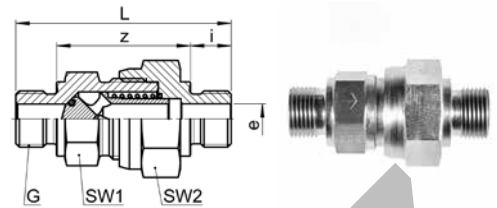
SO 6611

Type -G	Mat.-Nr.	bar	SW1	SW2	L	i	z	e	kg/100	
G=Rohrgewinde (zylindrisch)			G=Filetage-gaz BSP (cylindrique)			G=BSP thread (parallel)				
SO 6611-1/8	228.6110.020	250	14	17	41.0	8.0	25.0	3.8	3.700	
SO 6611-3/8	228.6110.060	200	24	30	64.0	12.0	40.0	8.8	15.800	
SO 6611-1/2	228.6110.080	160	27	30	69.0	14.0	41.0	11.0	18.500	
SO 6611-3/4	228.6110.120	160	41	46	81.0	16.0	49.0	16.0	45.000	

Kegelrückschlagventil

mit Einschraubgewinde und Rohranschluss

Clapet anti-retour à siège conique

avec filetage et connexion pour tube

Taper seat non-return valve

with male adaptor thread and tube connection

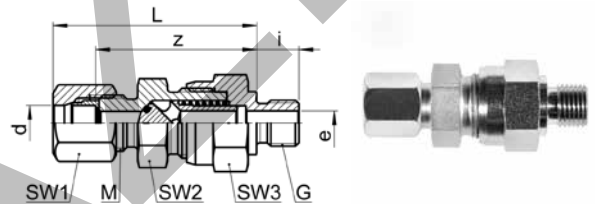
SO 6613

Type -d-G	Mat.-Nr.	bar	M	SW1	SW2	SW3	L	i	z	e	kg/100
G=Rohrgewinde (zylindrisch)			G=Filetage-gaz BSP (cylindrique)			G=BSP thread (parallel)					
SO 6613-6-1/8	228.6130.100	250	12x1.5	14	14	17	44.0	8.0	36.0	3.8	5.000
SO 6613-10-1/4	228.6130.270	200	16x1.5	19	22	24	56.5	12.0	46.0	6.8	13.100
SO 6613-12-3/8	228.6130.390	200	18x1.5	22	24	30	60.0	12.0	48.5	8.8	20.200

Anschraubfuss

Support de fixation

Flange mount

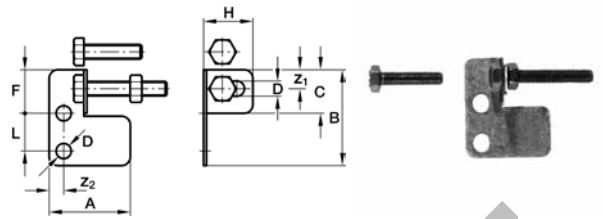
SO 09900

Type	Mat.-Nr.	L	A	B	C	D	F	H	z2	z1	kg/100
SO 09900	028.2750.000	13.0	28.0	33.0	15.0	5.2	15.0	17.0	5.0	6.5	1.660

Werkstoff:

- Fuss: Inox 1.4571

- Schraube/Mutter: Stahl 8.8 schwarz

Matériau:

Support: inox 1.4571

Vis/écrou: acier 8.8 noir

Material:

Mount: inox 1.4571

Screw/nut: steel 8.8 black

Für die Wandmontage sämtlicher Grössen der Ventiltypen SO NV 41A21 / SO NV 41C21 und SO NV 01A21 / SO NV 01C21

Pour le montage mural de tous les dimensions des vannes SO NV 41A21 / SO NV 41C21 et SO NV 01A21 / SO NV 01C21

For wallmounting of all valves, types SO NV 41A21 / SO NV 41C21 and SO NV 01A21 / SO NV 01C21

Handrad

für Regulierventile Messing M und G, Polyamid

Volant

pour vannes de réglage laiton M e G, polyamide

Handwheel

for regulating valves brass M and G, polyamide

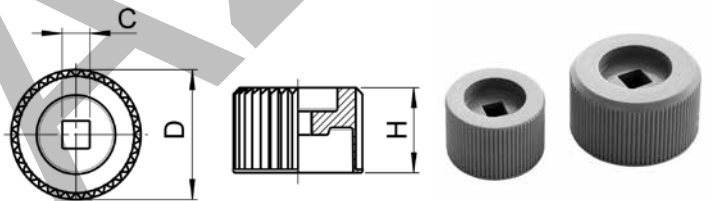
SO 09950

Type	Mat.-Nr.	D	H	C	kg/100
SO 09950 D26	025.1220.080	26.0	17.0	5.5	0.600
SO 09950 D36	025.1220.150	36.0	19.5	7.0	1.300

Ventilschilder (Satz)

Plaques signalétiques (set)

Valve labels (set)

12

VSD SO NV



Type	Mat.-Nr.	Inhalt / Cont.
VSD NV 01A/31A/51A-6/8 (RV) colored	065.1000.001	2 Stk./pc.
VSD NV 51A-10/12/15 (RV) colored	065.1000.002	2 Stk./pc.
VSD NV 01C/51C-6/8 (FRV) colored	065.1000.010	2 Stk./pc.
VSD NV 51C-10/12/15 (FRV) colored	065.1000.011	2 Stk./pc.
VSD NV 01A+C/31A/51A+C-6/8 (RV/FRV) black	065.1001.080	10 Stk./pc.
VSD NV 51A+C-10/12/15 (RV/FRV) black	065.1001.150	10 Stk./pc.
VSD SO NV41A Set RV	255.1001.001	3 Stk./pc.
VSD SO NV41C Set FRV	255.1001.002	3 Stk./pc.
VSD SO NV41A Set grey / RV	255.1101.122	10 Stk./pc.
VSD SO NV41C Set grey / FRV	255.1101.222	10 Stk./pc.

065.1000.001:

für Regulierventil (RV) MsG/PA/Inox, Grösse 6-8 grün/gelb, blau/rot eloxiert (VPE = je 1 Stk.)

065.1000.002:

für Regulierventil (RV) Inox, Grösse 10-15 grün/gelb, blau/rot eloxiert (VPE = je 1 Stk.)

065.1000.010:

für Feinregulierventil (FRV) MsG/PA/Inox, Grösse 6-8 grün/gelb, blau/rot eloxiert (VPE = je 1 Stk.)

065.1000.011:

für Feinregulierventil (FRV) Inox, Grösse 10-15 grün/gelb, blau/rot eloxiert (VPE = je 1 Stk.)

065.1001.080:

für Regulier-/Feinregulierventil (RV/FRV) MsG/PA/Inox Grösse 6-8 schwarz eloxiert (VPE = 10 Stk.)

065.1001.150:

für Regulier-/Feinregulierventil (RV/FRV) Inox Grösse 10-15 schwarz eloxiert (VPE = 10 Stk.)

255.1001.001:

für Regulierventil (RV) MsM/G, rot/blau/grün (VPE = je 1 Stk.)

255.1001.002:

für Feinregulierventil (FRV) MsM/G, rot/blau/grün (VPE = je 1 Stk.)

255.1101.122:

für Regulierventil (RV) MsM/G, grau (VPE = 10 Stk.)

255.1101.222:

für Feinregulierventil (FRV) MsM/G, grau (VPE = 10 Stk.)

065.1000.001:

pour vanne de réglage (RV) laiton G/PA/Inox, tailles 6-8 vert/jaune, bleu/rouge anodisé (UE = 1 pc. chacun)

065.1000.002:

pour vanne de réglage (RV) inox, tailles 10-15 vert/jaune, bleu/rouge anodisé (UE = 1 pc. chacun)

065.1000.010:

pour vanne de réglage fin (FRV) laiton G/PA/Inox, tailles 6-8 vert/jaune, bleu/rouge anodisé (UE = 1 pc. chacun)

065.1000.011:

pour vanne de réglage fin (FRV) inox, tailles 10-15 vert/jaune, bleu/rouge anodisé (UE = 1 pc. chacun)

065.1001.080:

pour vanne de réglage/régl. fin (RV/FRV) laiton G/PA/Inox tailles 6-8 noir anodisé (UE = 10 pcs.)

065.1001.150:

pour vanne de réglage/régl. fin (RV/FRV) inox tailles 10-15 noir anodisé (UE = 10 pcs.)

255.1001.001:

pour vanne de réglage (RV) laiton M/G, rouge/bleu/vert (UE = 1 pc. chacun)

255.1001.002:

pour vanne de réglage fin (FRV) laiton M/G, rouge/bleu/vert (UE = 1 pc. chacun)

255.1101.122:

pour vanne de réglage (RV) laiton M/G, gris (UE = 10 pcs.)

255.1101.222:

pour vanne de réglage fin (FRV) laiton M/G, gris (UE = 10 pcs.)

065.1000.001:

for regulating valve (RV) brass G/PA/Inox, sizes 6-8 green/yellow, blue/red anodized (PU = 1 pc. each)

065.1000.002:

for regulating valve (RV) Inox, sizes 10-15 green/yellow, blue/red anodized (PU = 1 pc. each)

065.1000.010:

for fine regulating valve (FRV) brass G/PA/Inox, sizes 6-8 green/yellow, blue/red anodized (PU = 1 pc. each)

065.1000.011:

for fine regulating valve (FRV) Inox, sizes 10-15 green/yellow, blue/red anodized (PU = 1 pc. each)

065.1001.080:

for regulating-/fine regulating valve (RV/FRV) brass G/PA/Inox sizes 6-8 black anodized (PU = 10 pcs.)

065.1001.150:

for regulating-/fine regulating valve (RV/FRV) Inox sizes 10-15 black anodized (PU = 10 pcs.)

255.1001.001:

for regulating valve (RV) brass M/G, red/blue/green (PU = 1 pc. each)

255.1001.002:

for fine regulating valve (FRV) brass M/G, red/blue/green (PU = 1 pc. each)

255.1101.122:

for regulating valve (RV) brass M/G, grey (PU = 10 pcs.)

255.1101.222:

for fine regulating valve (FRV) brass M/G, grey (PU = 10 pcs.)

Konfektionieren von Rohren und Schläuchen

Konfektionierte Schläuche

Wir längen Schläuche automatisch ab, biegen und verpressen die Armaturen, kontrollieren und testen in unserer eigenen Prüf- und Versuchswerkstatt. Und immer öfter liefern wir ganze Baugruppen.

Assemblage des tubes et tuyaux

Tuyaux pré-montés

Nous sectionnons automatiquement les tuyaux et nous sertissons les armatures, nous contrôlons et testons dans notre propre atelier d'essai et de contrôle. Et de plus en plus souvent, nous livrons des modules complets.

Pre-assembly of tubes and hoses

Pre-assembled hoses

We automatically cut hoses to length, bend and mount fittings, and then send them to our own test workshop where they are thoroughly checked and tested. And today we are even supplying more and more complete subassemblies.



Rohrsysteme

Die Kompetenz von SERTO im Bereich Konfektionierung beginnt beim Einkauf und der Lagerung der Rohre, erstreckt sich über den Einsatz der optimalen Bearbeitungs- und Biegemaschinen, die Qualitätskontrolle bis hin zur Komplettierung der Rohre mit Verschraubungen oder der Montage von Baugruppen – ganz nach Kundenwunsch.

Tubes sur mesure

La compétence de SERTO dans le domaine de la confection commence dès l'achat et le stockage des tubes, s'étend à l'utilisation optimale des machines de cintrage et d'usinage, au contrôle qualité et selon la demande du client, se poursuit jusqu'à l'assemblage des tubes avec des raccords ou au montage des composants.

Tube systems

SERTO's competence in the field of assembly starts with the purchasing and storage of the tubes, and extends to the use of optimal processing and bending machines, quality control and the completion of the tubes with unions or installation of assemblies - according to the customer's requirements.



Ventile Kunststoff

PVDF, PA

Vannes en plastique

PVDF, PA

Valves in plastic

PVDF, PA



Seite/Page/Page

Seite/Page/Page

Ventile Kunststoff PVDF
Vannes plastique PVDF
Valves plastic PVDF

Ventile Kunststoff PA
Vannes plastique PA
Valves plastic PA

Alle Ventile Kunststoff
Toutes vannes en plastique
All valves in plastic

Bestätigungen auf www.serto.com
Confirmations sur www.serto.com
Confirmations on www.serto.com

Regulierventil
 Vanne de réglage
 Regulating valve

557-559



SO NV 22A21

Regulierventil
 Vanne de réglage
 Regulating valve

567-569



SO NV 32A21



nur PVDF
 seulement PVDF
 only PVDF

Regulier-Eckventil
 Vanne-équerre de réglage
 Elbow regulating valve

560-561



SO NV 22A21E

Regulier-Eckventil
 Vanne-équerre de réglage
 Elbow regulating valve

570-572



SO NV 31A21E

Zubehör
 Accessoires
 Accessories

561



SO 29900

Kegelrückschlagventil
 Clapet anti-retour à siège conique
 Taper seat non-return valve

573-575



SO CV 33B21

Kegelrückschlagventil
 Clapet anti-retour à siège conique
 Taper seat non-return valve

562-564



SO CV 23B21

Absperrhahn
 Vanne à boisseau
 Stopcock

576-577



SO BV 38A00

Absperrhahn
 Vanne à boisseau
 Stopcock

565-566



SO BV 28A00

Schwenkverschraubung
 Coude banjo
 Single banjo

578-579



SO 37621

Sonderausführungen auf Anfrage
Exécution en option sur demande
Optional services on request



Vorbeschichtete Gewinde mit Loctite 5061
 Filetages pré enduits avec Loctite 5061
 Pre-coated threads with Loctite 5061

Regulierventil

Vanne de réglage

Regulating valve

**SO NV 22A21 / A00 /
A21E / A21EB / A21EL**

13

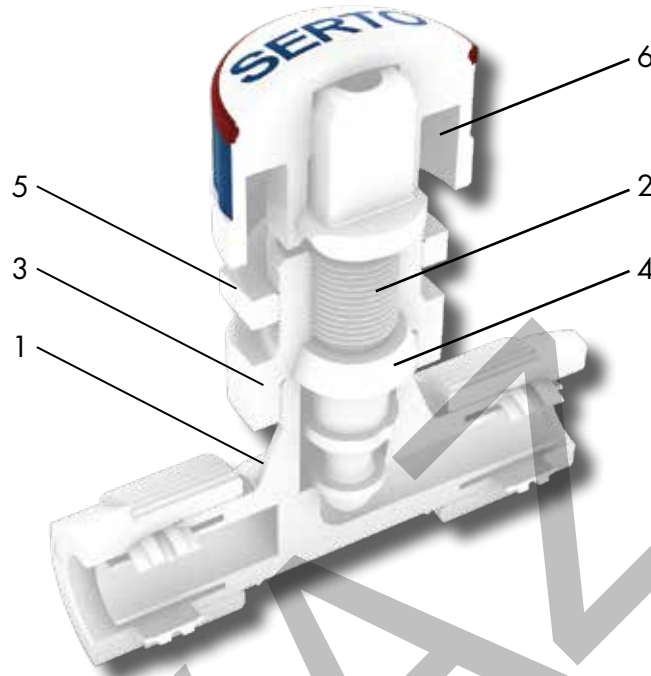

Nr. No. No.	Bezeichnung Désignation Description	Material Matériau Material	Nr. No. No.	Bezeichnung Désignation Description	Material Matériau Material	Nr. No. No.	Bezeichnung Désignation Description	Material Matériau Material
1	Ventilkörper Corps de vanne Valve body	PVDF (FDA)	3	Schalttafeloberteil Partie sup. tableau commande Panel top	PVDF (FDA)	5	Kontermutter Contre-écrou Counter nut	PVDF (FDA)
2	Ventilspindel Pointeau de vanne Valve spindle	PVDF (FDA)	4	Dichtscheibe Rondelle de joint Sealing washer	PTFE (FDA)	6*	Handrad Volant Handwheel	PVDF/TPE

Spezifikationen

Betriebsdruck (PN): 10 bar
 Temperatur: -20°C bis +100°C
 Sterilisierbar: bis +121°C
 Sicherheitsfaktor: 1.5-fach

Merkmale

- Funktion: Regulier- und Absperrventil
- Einsatz: Medizin, Reinraum und Laborbereich, für aggressive Medien (s. Beständigkeitsliste PVDF; TPE hat identische Beständigkeit wie PVDF)
- Zwei-Komponenten Handrad für rutschfreie Bedienung
- Besonderes: tottraumarme Konstruktion, kompakte Baugrößen

* Optionen

- Nr. 6: austauschbare Markierungsringe in neutral (weiss), blau, rot, gelb, grün (im Lieferumfang enthalten)
- Varianten: mit Übergangsmuffe SO 20030 oder Einstellnippel SO 21600/21624

Spécifications

Pression de service (PN): 10 bar
 Température: -20°C à +100°C
 Stérilisable: jusqu'à +121°C
 Facteur de sécurité: 1.5 fois

Caractéristiques

- Fonction: vanne de régulation et de retenue
- Application: médecine, salle blanche et laboratoire, pour des fluides agressifs (voir liste de résistance PVDF; TPE offrant une résistance identique à celle du PVDF)
- Volant manuel bi-composant antidérapant
- Particularités: construction sans espace mort, dimensions compactes

* Options

- No. 6: bague d'identification interchangeable de couleur neutre (blanc), bleu, rouge, jaune, vert (fournies d'origine)
- Autres versions: avec adaptateur femelle SO 20030 ou union orientable mâle SO 21600/21624

Specifications

Working pressure (PN): 10 bar
 Temperature: -20°C to +100°C
 Sterilizable: up to +121°C
 Safety factor: 1.5 times

Characteristics

- Function: regulating and stop valve
- Uses: medical, clean room and laboratories, for aggressive media (see chemical resistance list PVDF; TPE has identical properties as PVDF)
- Two-piece hand wheel for non-slip operation
- Special: zero static construction, compact sizes

* Options

- No. 6: exchangeable marking rings in neutral (white), blue, red, yellow, green (included in the scope of delivery)
- Other versions: with female adaptor SO 20030 or adjustable male adaptor SO 21600/21624

Durchflussdiagramm

Gültig für die aufgeführten Typen.

Courbe de débit

Valable pour les types indiqués.

Flow rate

Valid for the specified types.

SO NV 22A00 / SO NV 22A21 / SO NV 22A21E / SO NV 22A21EB / SO NV 22A21EL

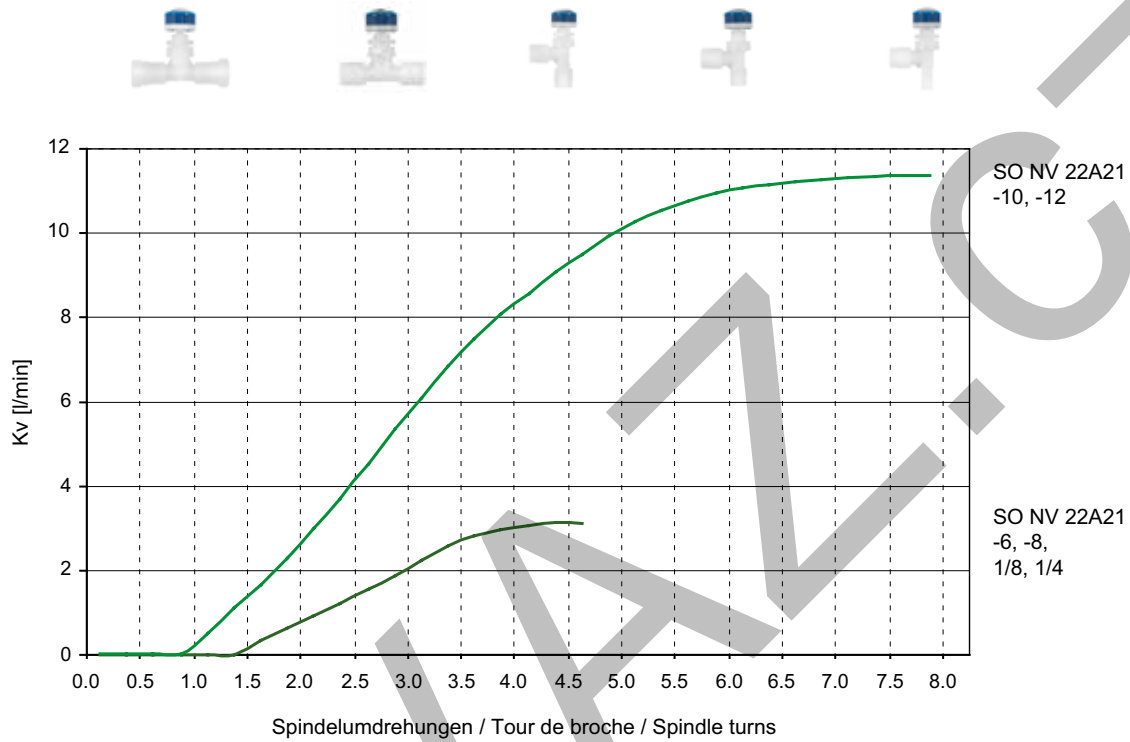

Sonderausführungen

siehe Kapitelübersicht

Exécutions en option

voir aperçu du chapitre

Optional services

see chapter overview

Zubehör

- Anschraubfuss für Wandmontage SO 29900

Accessoires

- Support de fixation SO 29900

Accessoires

- Flange mount for wall fastening SO 29900

Regulierventil

mit Innengewinde

Vanne de réglage

avec taraudage

Regulating valve

with female thread

SO NV 22A00

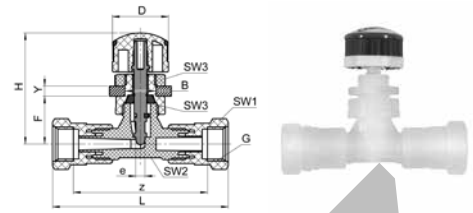

13

Type -G	Mat.-Nr.	bar	SW1	SW2	SW3	L	D	H	B	F	z	e	kv	kg/100
G=Rohrgewinde (zylindrisch)			G=Filetage-gaz BSP (cylindrique)					G=BSP thread (parallel)						
SO NV 22A00-1/8	148.1000.042	10	14	10	17	59.0	21.5	42.5	12.5	18.0	45.0	3.5	2.2	2.200
SO NV 22A00-1/4	148.1000.104	10	17	11	17	67.0	21.5	42.5	12.5	18.0	51.0	3.5	3.3	2.700
SO NV 22A00-3/8	148.1000.166	10	22	14	24	75.0	29.5	61.5	18.5	26.0	58.0	7.0	10.0	5.600

Y = max. 3 mm ≤ Anschlussgröße 1/4
max. 8 mm ≥ Anschlussgröße 3/8

Y = max. 3 mm ≤ Dimension 1/4
max. 8 mm ≥ Dimension 3/8

Y = max. 3 mm ≤ Dimension 1/4
max. 8 mm ≥ Dimension 3/8

Montagehinweis: Nippel ist handfest montiert. Bei Endmontage mit 1/4 Umdrehung anziehen.
Wir empfehlen eine zusätzliche Schmierung auf der Planfläche.

Note d'installation: L'adaptateur femelle-mâle est monté serré à la main. Pour le montage final, serrer avec 1/4 de tour.
Nous recommandons une lubrification supplémentaire sur la surface plane.

Assembly information: Male adaptor is mounted finger-tight. For final assembly, tighten with 1/4 turn.
We recommend additional lubrication on the plane surface.

Regulierventil

Vanne de réglage

Regulating valve

SO NV 22A21

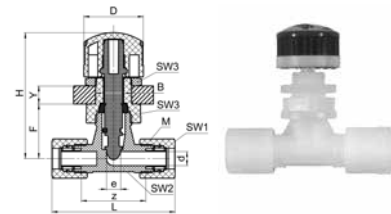

Type -d	Mat.-Nr.	bar	M	SW1	SW2	SW3	L	D	H	B	F	z	e	kv	kg/100
SO NV 22A21-6	148.1010.060	10	10x1.0	12	10	17	51.0	21.5	42.5	12.5	18.0	28.0	3.5	2.2	2.000
SO NV 22A21-8	148.1010.080	10	12x1.0	14	11	17	56.0	21.5	42.5	12.5	18.0	29.0	3.5	3.3	2.400
SO NV 22A21-10	148.1010.100	10	14x1.0	17	14	24	61.0	29.5	61.5	18.5	26.0	32.0	7.0	10.0	5.100
SO NV 22A21-12	148.1010.120	10	16x1.0	19	16	24	68.0	29.5	61.5	18.5	26.0	32.0	7.0	12.1	5.700

Y = max. 3 mm ≤ Anschlussgröße 8
max. 8 mm ≥ Anschlussgröße 10

Y = max. 3 mm ≤ Dimension 8
max. 8 mm ≥ Dimension 10

Y = max. 3 mm ≤ Dimension 8
max. 8 mm ≥ Dimension 10

d=Rohrussen-ø
e=kleinste Bohrung
kv=Kenngröße für das Durchflussverhalten (l/min)
L=Mass in montiertem Zustand
H=Ventil geöffnet

d=ø extérieur du tube
e=ø-min. de passage
kv=facteur d'écoulement (l/min)
L=après montage
H=vanne ouvert

d=tube outside diameter
e=minimum bore
kv=flow factor (l/min)
L=installed length
H=valve opened

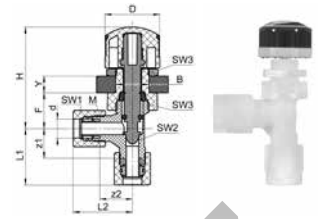
Regulier-Eckventil
Vanne-équerre de réglage
Elbow regulating valve

SO NV 22A21E

Type -d	Mat.-Nr.	bar	M	SW1	SW2	SW3	L1	L2	H	B	F	z1	z2	e	kv	kg/100
SO NV 22A21E-6	148.1410.060	10	10x1.0	12	10	17	26.0	26.0	38.0	12.5	13.5	14.0	14.0	3.5	2.7	2.000
SO NV 22A21E-8	148.1410.080	10	12x1.0	14	11	17	28.5	28.5	38.0	12.5	13.5	15.0	15.0	3.5	5.3	2.300
SO NV 22A21E-10	148.1410.100	10	14x1.0	17	14	24	30.5	32.0	54.0	18.5	18.0	16.0	17.5	7.0	14.7	5.000
SO NV 22A21E-12	148.1410.120	10	16x1.0	19	16	24	34.0	35.5	53.0	18.5	18.0	16.0	17.5	7.0	22.3	5.600

D = \varnothing 21,5 mm \leq Anschlussgrösse 8
 \varnothing 29,5 mm \geq Anschlussgrösse 10

D = \varnothing 21,5 mm \leq Dimension 8
 \varnothing 29,5 mm \geq Dimension 10

D = \varnothing 21,5 mm \leq Dimension 8
 \varnothing 29,5 mm \geq Dimension 10

Y = max. 3 mm \leq Anschlussgrösse 8
 max. 8 mm \geq Anschlussgrösse 10

Y = max. 3 mm \leq Dimension 8
 max. 8 mm \geq Dimension 10

Y = max. 3 mm \leq Dimension 8
 max. 8 mm \geq Dimension 10

Regulier-Eckventil

mit Einschraubgewinde

Vanne-équerre de réglage

avec filetage

Elbow regulating valve

with male adaptor thread

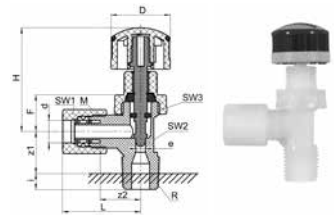
SO NV 22A21EB

Type -d-R	Mat.-Nr.	bar	M	SW1	SW2	SW3	L	H	F	i	z1	z2	e	kv	kg/100
R=Rohrgewinde (kegelig)															
R=Filetage-gaz BSP (conique)															
R=BSP thread (tapered)															
SO NV 22A21EB-6-1/4	148.1410.110	10	10x1.0	12	10	17	25.0	38.0	13.5	12.0	8.5	14.0	3.5	2.7	1.900
SO NV 22A21EB-8-1/4	148.1410.170	10	12x1.0	14	11	17	28.0	38.0	13.5	12.0	9.0	15.0	3.5	5.3	2.100

D = \varnothing 21,5 mm \leq Anschlussgrösse 8

D = \varnothing 21,5 mm \leq Dimension 8

D = \varnothing 21,5 mm \leq Dimension 8

d=Rohraussen- \varnothing
 e=kleinste Bohrung
 kv=Kenngrösse für das Durchflussverhalten (l/min)
 L=Mass in montiertem Zustand
 H=Ventil geöffnet

d= \varnothing extérieur du tube
 e= \varnothing -min. de passage
 kv=facteur d'écoulement (l/min)
 L=après montage
 H=vanne ouvert

d=tube outside diameter
 e=minimum bore
 kv=flow factor (l/min)
 L=installed length
 H=valve opened

Regulier-Eckventil

mit Einstellzapfen

Vanne-équerre de réglage

orientable

Elbow regulating valve

adjustable

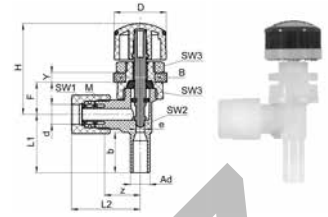

13

SO NV 22A21EL

Type -d-Ad	Mat.-Nr.	bar	M	SW1	SW2	SW3	L1	L2	H	B	F	b	z	e	kv	kg/100
SO NV 22A21EL-6-A6	148.1500.060	10	10x1.0	12	10	17	22.0	25.5	38.0	12.5	13.5	15.0	14.0	3.5	2.7	1.700
SO NV 22A21EL-8-A8	148.1500.080	10	12x1.0	14	11	17	24.0	28.5	38.0	12.5	13.5	16.5	15.0	3.5	5.3	1.900

D = ø 21,5 mm
Y = max. 3 mm

D = ø 21,5 mm
Y = max. 3 mm

D = ø 21,5 mm
Y = max. 3 mm

Empfehlung: Für die einfache und korrekte Platzierung des Klemmrings die Montagehilfe AC 870 verwenden.

Recommendation: Pour un positionnement facile et correct de la bague de serrage, utiliser l'aide au montage AC 870.

Recommendation: For easy and correct placement of the compression ferrule, use the assembly aid AC 870.

Anschraubfuss Support de fixation Flange mount

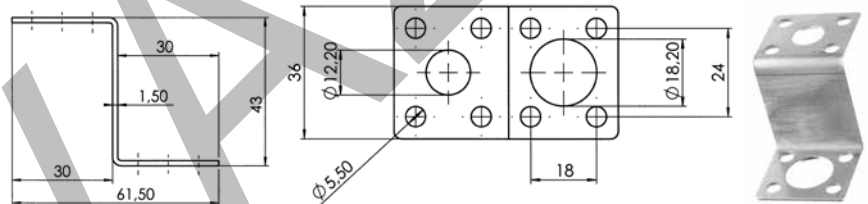

SO 2990

Type	Mat.-Nr.	kg/100
SO 2990	146.6006.001	0.500

Werkstoff: Inox 1.4571

Matériau: Inox 1.4571

Material: Inox 1.4571

Passend zu allen PVDF und PA Regulierventilen.

Approprié pour tous les vannes de réglage en PVDF et PA.

Suitable for all PVDF and PA regulating valves.

d=Rohrassen-ø
Ad=Aussen-ø der Andrehung
e=kleinste Bohrung
kv=Kenngröße für das Durchflussverhalten (l/min)
L=Mass in montiertem Zustand
H=Ventil geöffnet

d=ø extérieur du tube
Ad=ø extérieur de la portée cylindrique
e=ø-min. de passage
kv=facteur d'écoulement (l/min)
L=après montage
H=vanne ouvert

d=tube outside diameter
Ad=outside diameter of cyl. stub
e=minimum bore
kv=flow factor (l/min)
L=installed length
H=valve opened

Kegelrückschlagventil

Clapet anti-retour à siège conique

Taper seat non-return valve

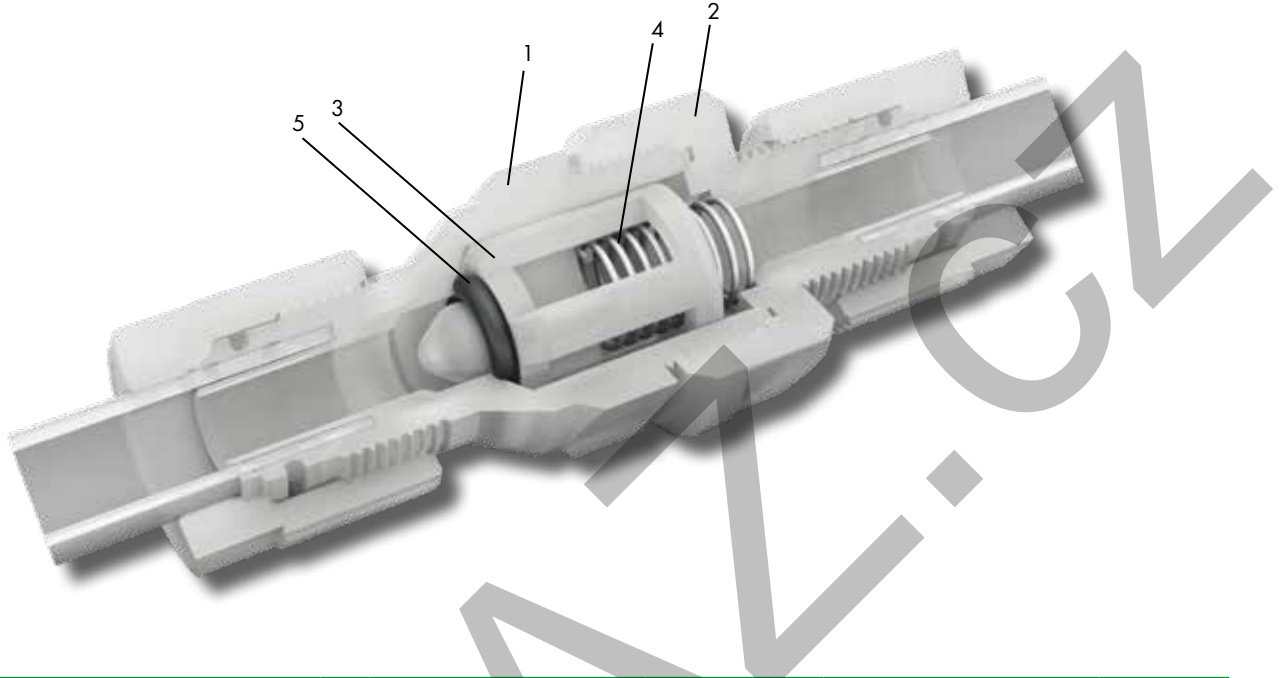
SO CV 23B21

Nr. No.	Bezeichnung Désignation Description	Material Matériau Material	Nr. No.	Bezeichnung Désignation Description	Material Matériau Material	Nr. No.	Bezeichnung Désignation Description	Material Matériau Material
1	Ventilsitz Siège du clapet Valve seat	PVDF (FDA)	3	Ventilkegel Cône du clapet Valve cone	PVDF (FDA)	5*	Dichtung Joint Seal	FKM (FDA)
2	Ventilmutter Écrou du clapet Valve nut	PVDF (FDA)	4	Druckfeder Ressort de compression Compression spring	Hastelloy® 2.4610 C4			

Spezifikationen

Betriebsdruck (PN): 10 bar
 Temperatur: -20°C bis +100°C
 Sterilisierbar: bis +121°C
 Öffnungsdruck: 0.2 ± 0.1 bar
 Sicherheitsfaktor: 1.5-fach

Merkmale

- Funktion: Rückflussverhinderer
- Einsatz: Medizin, Reinraum und Laborbereich, für aggressive Medien (s. Beständigkeitsliste PVDF und FKM)
- Besonderes: geringer Druckverlust durch strömungsgünstige Konstruktion

* Optionen

- Nr. 5 - Dichtung: EPDM, FFKM
- Varianten: mit Übergangsmuffe SO 20030

Spécifications

Pression de service (PN): 10 bar
 Température: -20°C à +100°C
 Stérilisable: jusqu'à +121°C
 Pression d'ouverture: 0.2 ± 0.1 bar
 Facteur de sécurité: 1.5 fois

Caractéristiques

- Fonction: clapet anti-retour
- Application: médical, salle blanche et laboratoire, pour fluides agressifs (voir liste de résistance PVDF et FKM)
- Particularités: faible perte de pression grâce à la conception favorisant l'écoulement

* Options

- No. 5 - Joint: EPDM, FFKM
- Autres versions: avec adaptateur femelle SO 20030

Specifications

Working pressure (PN): 10 bar
 Temperature: -20°C to +100°C
 Sterilizable: up to +121°C
 Opening pressure: 0.2 ± 0.1 bar
 Safety factor: 1.5 times

Characteristics

- Function: check valve
- Uses: medical, clean room and laboratories, for aggressive media (see chemical resistance list PVDF and FKM)
- Special: low pressure loss due to flow-optimised design

* Options

- No. 5 - Seal: EPDM, FFKM
- Other versions: with female adaptor SO 20030

Durchflussdiagramm

Der Druckabfall nimmt mit zunehmendem Durchfluss überproportional zu.

Courbe de débit

La perte de pression augmente disproportionnellement avec plus de débit.

Flow rate

The pressure drop increases disproportionately with increasing flow rate.

SO CV 23B21

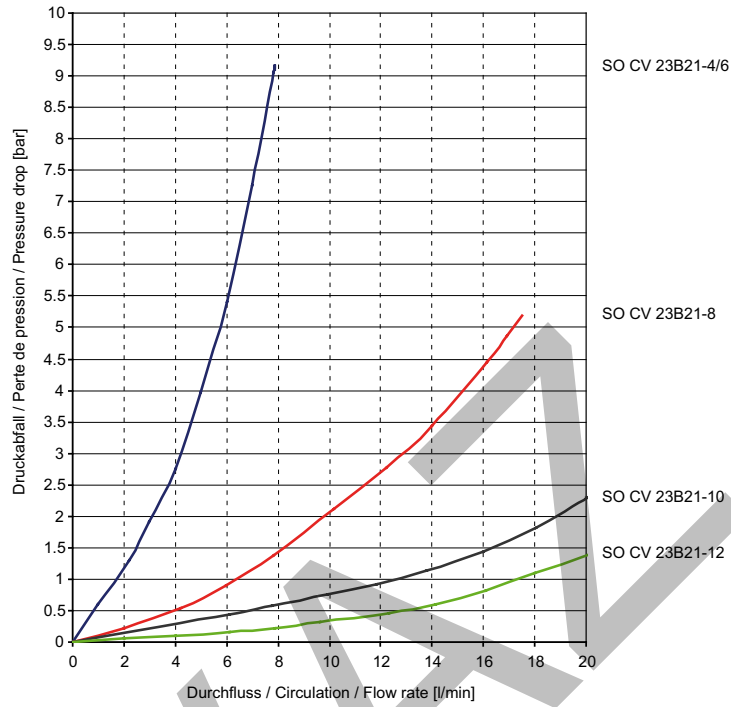

Sonderausführungen

siehe Kapitelübersicht

Exécutions en option

voir aperçu du chapitre

Optional services

see chapter overview

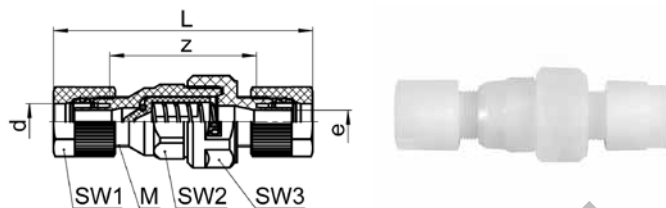
Kegelrückschlagventil
Clapet anti-retour à siège conique
Taper seat non-return valve

SO CV 23B21

Type-d	Mat.-Nr.	bar	M	SW1	SW2	SW3	L	z	e	kg/100
* SO CV 23B21-4	148.3010.040	10	10x1.0	12	17	19	56.5	34.0	2.9	1.500
SO CV 23B21-6	148.3010.060	10	10x1.0	12	17	19	56.5	34.0	2.9	1.400
SO CV 23B21-8	148.3010.080	10	12x1.0	14	17	19	61.5	35.5	4.9	1.600
SO CV 23B21-10	148.3010.100	10	14x1.0	17	19	24	69.5	41.0	6.5	2.800
SO CV 23B21-12	148.3010.120	10	16x1.0	19	19	24	74.5	39.0	7.5	3.400

d=Rohrassens-ø
 e=kleinste Bohrung
 L=Mass in montiertem Zustand
 *=mit reduziertem Klemmring

d=ø extérieur du tube
 e=ø-min. de passage
 L=après montage
 *=avec bague de serrage de réduction

d=tube outside diameter
 e=minimum bore
 L=installed length
 *=with reduction compression ferrule

Absperrhahn

Vanne à boisseau

Stopcock

SO BV 28A00
SO BV 28A21

13

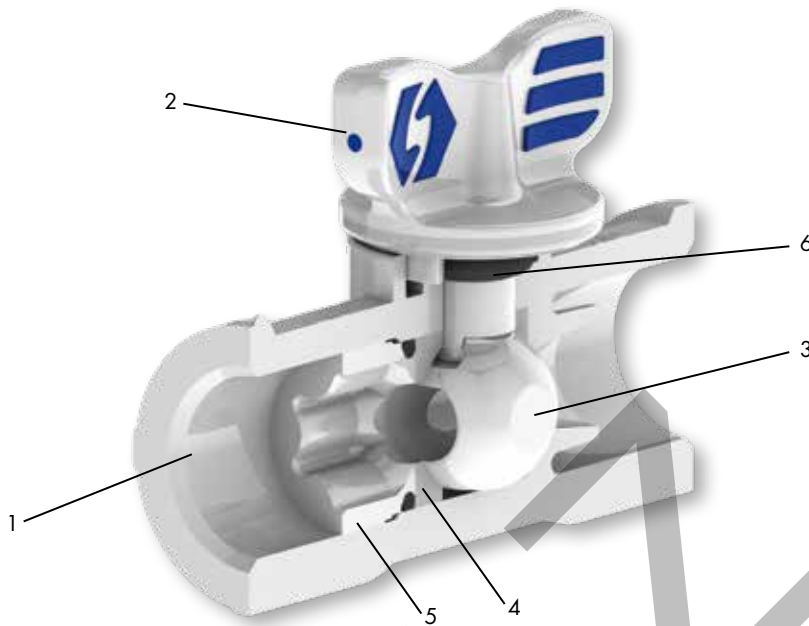

Nr. No. No.	Bezeichnung Désignation Description	Material Matériau Material	Nr. No. No.	Bezeichnung Désignation Description	Material Matériau Material	Nr. No. No.	Bezeichnung Désignation Description	Material Matériau Material
1	Gehäuse Corps Body	PVDF (FDA)	3	Ventilkugel Bille de vanne Valve ball	PVDF (FDA)	5	Druckschraube Vis de serrage Adjusting screw	PVDF (FDA)
2	Drehgriff Poignée Turning handle	PVDF/TPE	4	Dichtscheibe Rondelle d'étanchéité Sealing washer	PTFE (FDA)	6	Dichtung Joint Seal	FKM (FDA)

Spezifikationen

Betriebsdruck (PN): 10 bar
 Temperatur: -20°C bis +80°C
 Sicherheitsfaktor: 1.5-fach

Merkmale

- Funktion: Durchfluss öffnen und absperren
- Einsatz: Medizin, Chemie und Pharma, Wasseraufbereitung; für aggressive Medien (s. Beständigkeitsliste)
- Besonderes: zwei-Komponenten Drehgriff für rutschfreie Bedienung, totraumarme Konstruktion, kompakte Baugrößen, integrierte Löcher für Befestigung, verwendeter PVDF-Rohstoff und Dichtringe sind FDA-konform, nachstellbare Dichtung bei Verschleisserscheinungen

Sonderausführungen

siehe Kapitelübersicht

Optionen

Variante: mit Rohranschluss (Version SO BV 28A21)

Spécifications

Pression de service (PN): 10 bar
 Température: -20°C à +80°C
 Facteur de sécurité: 1.5 fois

Caractéristiques

- Fonction: ouvrir ou fermer le débit
- Application: médecine, chimie, pharmaceutique, traitement de l'eau; pour des fluides agressifs (voir liste de résistance)
- Particularités: poignée bi-composant anti-dérapant, construction sans espace mort, dimensions compactes, trous intégrés pour montage, matières premières PVDF utilisées et les joints sont conformes à la FDA, joint réglable, quand des signes d'usure apparaissent

Exécutions en option

voir aperçu du chapitre

Options

Autre version: avec raccord du tube (type SO BV 28A21)

Specifications

Working pressure (PN): 10 bar
 Temperature: -20°C to +80°C
 Safety factor: 1.5 times

Characteristics

- Function: open and shut-off flow
- Uses: medical, chemical and pharma industry, water treatment; for aggressive media (see chemical resistance list)
- Special: two-piece turning handle for non-slip operation, low dead space design, compact sizes, integrated holes for mounting, used PVDF raw material and sealing are FDA compliant, adjustable sealing when sign of wear is showing

Optional services

see chapter overview

Options

Other version: with tube connection (type SO BV 28A21)

Absperrhahn

mit Innengewinde

Vanne à boisseau

avec taraudage

Stopcock

with female thread

SO BV 28A00

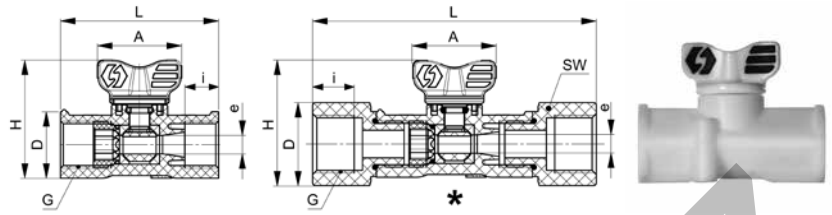

Type -G	Mat.-Nr.	bar	SW	L	D	H	A	a	c	i	kv	e	kg/100
SO BV 28A00-3/8	148.8100.060	10		56.5	24.0	42.0	30.0	15.8	22.3	12.0	22.0	6.6	3.070
SO BV 28A00-1/2 *	148.8100.080	10	27	102.0	30.0	45.0	30.0	15.8	22.3	15.0	22.0	6.6	6.510

Anwendungsbeispiele:

Exemples d'utilisation:

Sample combinations:

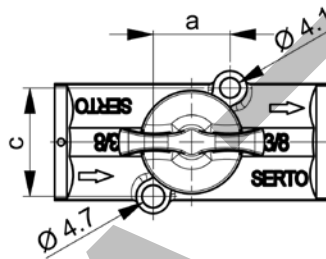

Absperrhahn

Vanne à boisseau

Stopcock

SO BV 28A21

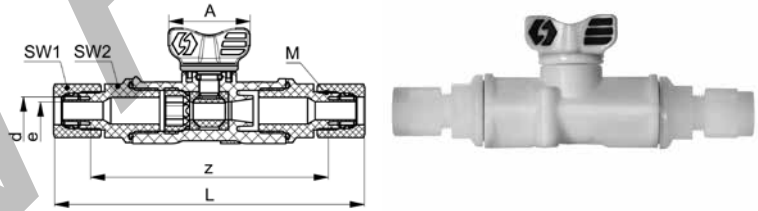

Type -d	Mat.-Nr.	bar	M	SW1	SW2	L	A	z	e	kg/100
SO BV 28A21-6	148.8110.060	10	10x1.0	12	17	110.0	30.0	89.0	2.8	4.930
SO BV 28A21-8	148.8110.080	10	12x1.0	14	17	114.0	30.0	89.0	4.8	5.110
SO BV 28A21-10	148.8110.100	10	14x1.0	17	17	114.0	30.0	88.0	6.6	5.570
SO BV 28A21-12	148.8110.120	10	16x1.0	19	17	120.0	30.0	86.0	6.6	6.070

d=Rohrassen-ø
 e=kleinste Bohrung
 kv=Kenngröße für das Durchflussverhalten (l/min)
 L=Mass in montiertem Zustand

d=ø extérieur du tube
 e=ø-min. de passage
 kv=facteur d'écoulement (l/min)
 L=après montage

d=tube outside diameter
 e=minimum bore
 kv=flow factor (l/min)
 L=installed length

Regulierventil

Vanne de réglage

Regulating valve

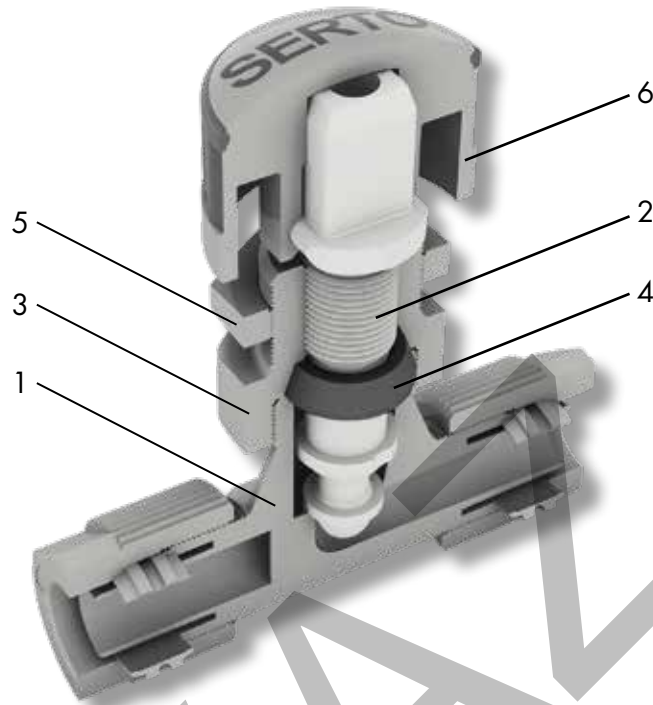
SO NV 32A21
13

Nr. No. No.	Bezeichnung Désignation Description	Material Matériau Material	Nr. No. No.	Bezeichnung Désignation Description	Material Matériau Material	Nr. No. No.	Bezeichnung Désignation Description	Material Matériau Material
1	Ventilkörper Corps de vanne Valve body	PA	3	Schalttafeloberteil Partie sup. tableau de commande Panel top	PA	5	Kontermutter Contre-écrou Counter nut	PA
2	Ventilspindel Pointeau de vanne Valve spindle	PVDF	4	Dichtscheibe Rondelle de joint Sealing washer	EPDM	6	Handrad Volant Handwheel	PA/TPE

Spezifikationen

Betriebsdruck (PN): 10 bar
 Temperatur: -20°C bis +40°C
 Sicherheitsfaktor: 1.5-fach

Merkmale

- Funktion: Regulier- und Absperrventil
- Einsatz: Pneumatik, Mess- und Regeltechnik, Maschinen- /Apparatebau, für nicht aggressive Medien (s. Beständigkeitsliste PA; TPE hat identische Beständigkeit wie PA)
- Zwei-Komponenten Handrad für rutschfreie Bedienung
- Besonderes: totraumarme Konstruktion, kompakte Baugrößen

Spécifications

Pression de service (PN): 10 bar
 Température: -20°C à +40°C
 Facteur de sécurité: 1.5 fois

Caractéristiques

- Fonction: vanne de régulation et de retenue
- Application: pneumatique, systèmes de mesure et de régulation, construction de machines et d'appareils, pour des fluides non agressifs (voir liste de résistance PA; TPE offrant une résistance identique à celle du PA)
- Volant manuel bi-composant antidérapant
- Particularités: construction sans espace mort, dimensions compactes

Specifications

Working pressure (PN): 10 bar
 Temperature: -20°C to +40°C
 Safety factor: 1.5 times

Characteristics

- Function: regulating and stop valve
- Uses: pneumatics, measurement and control technology, machine and apparatus engineering, for non-aggressive media (see chemical resistance list PA; TPE has identical properties as PA)
- Two-piece hand wheel for non-slip operation
- Special: zero static construction, compact sizes

Durchflussdiagramm

Courbe de débit

Flow rate

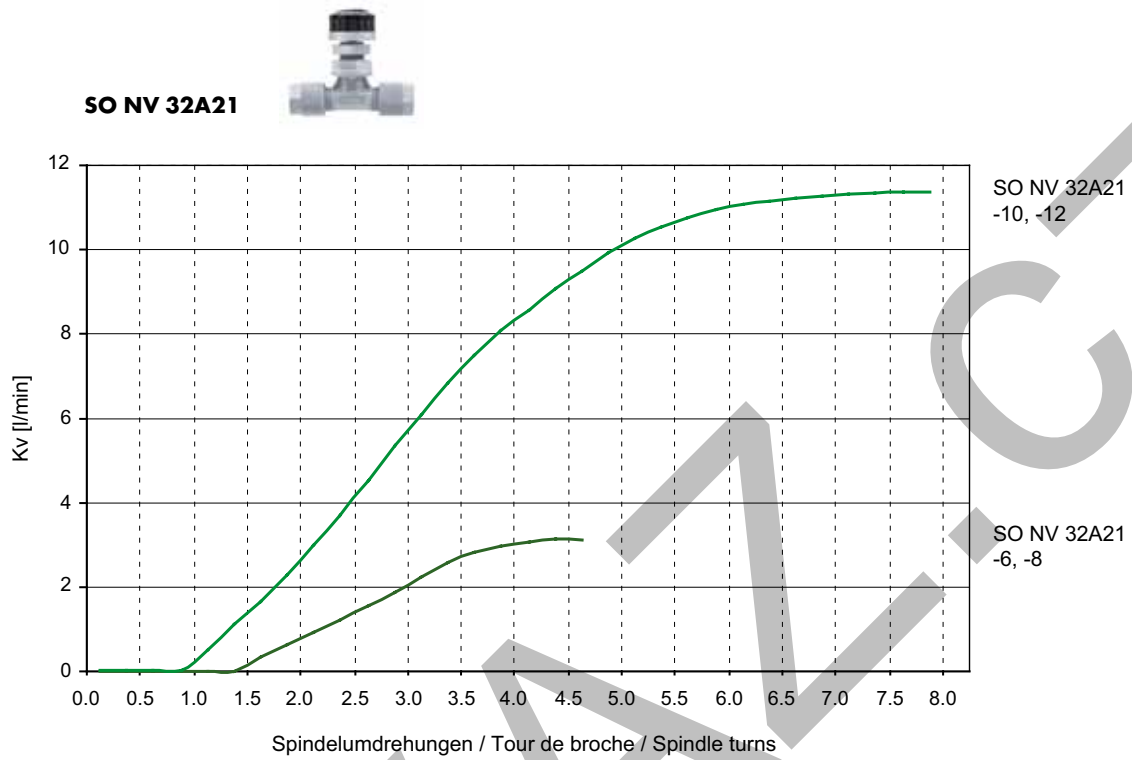

Zubehör

- Anschraubfuss für Wandmontage SO 29900

Accessoires

- Support de fixation SO 29900

Accessoires

- Flange mount for wall fastening SO 29900

Regulierventil
Vanne de réglage
Regulating valve

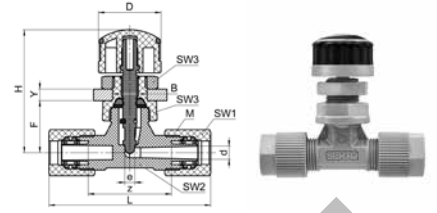

13

SO NV 32A21

Type -d	Mat.-Nr.	bar	M	SW1	SW2	SW3	L	D	H	B	F	z	e	kv	kg/100
SO NV 32A21-6	138.1010.060	10	10x1.0	12	10	17	51.0	21.5	42.5	12.5	18.0	28.0	3.5	2.2	1.500
SO NV 32A21-8	138.1010.080	10	12x1.0	14	11	17	56.0	21.5	42.5	12.5	18.0	29.0	3.5	3.3	1.800
SO NV 32A21-10	138.1010.100	10	14x1.0	17	14	24	61.0	29.5	61.5	18.5	26.0	32.0	7.0	10.0	4.000
SO NV 32A21-12	138.1010.120	10	16x1.0	19	16	24	68.0	29.5	61.5	18.5	26.0	32.0	7.0	12.1	4.500

Y = max. 3 mm ≤ Anschlussgröße 8
 max. 8 mm ≥ Anschlussgröße 10

Y = max. 3 mm ≤ Dimension 8
 max. 8 mm ≥ Dimension 10

Y = max. 3 mm ≤ Dimension 8
 max. 8 mm ≥ Dimension 10

d=Rohrassen-ø
 e=kleinste Bohrung
 kv=Kenngröße für das Durchflussverhalten (l/min)
 L=Mass in montiertem Zustand
 H=Ventil geöffnet

d=ø extérieur du tube
 e=ø-min. de passage
 kv=facteur d'écoulement (l/min)
 L=après montage
 H=vanne ouvert

d=tube outside diameter
 e=minimum bore
 kv=flow factor (l/min)
 L=installed length
 H=valve opened

Regulier-Eckventil
Vanne-équerre de réglage
Elbow regulating valve

SO NV 31A21E
SO NV 31A21EB

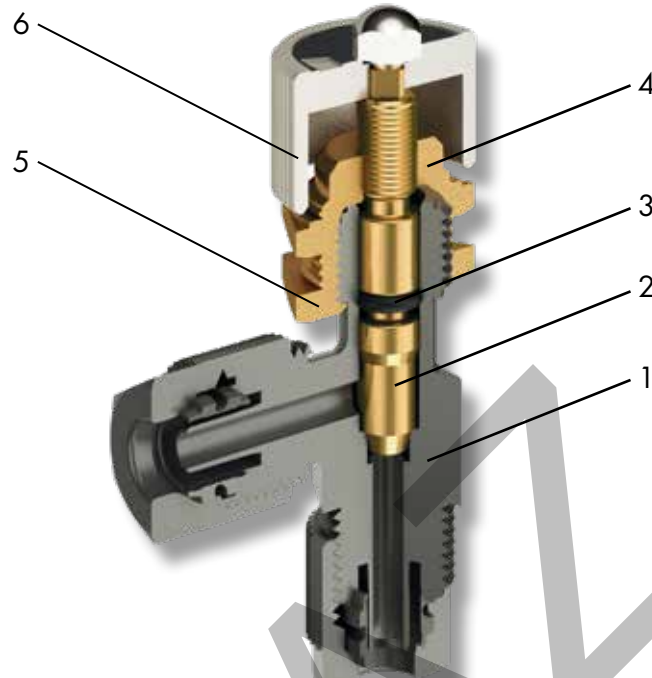

Nr. No. No.	Bezeichnung Désignation Description	Material Matériau Material	Nr. No. No.	Bezeichnung Désignation Description	Material Matériau Material	Nr. No. No.	Bezeichnung Désignation Description	Material Matériau Material
1	Ventilkörper Corps de vanne Valve body	PA	3	Dichtung Joint Seal	NBR	5	Kontermutter Contre-écrou Counter nut	Messing Laiton Brass
2	Ventilspindel Pointeau de vanne Valve spindle	Messing Laiton Brass	4	Ventilkappe Bouchon presse-étoupe Valve cap	Messing Laiton Brass	6	Handrad Volant Handwheel	Aluminium

Spezifikationen

Betriebsdruck (PN): 10 bar
 Temperatur: -20°C bis +40°C
 Sicherheitsfaktor: 1.5-fach

Merkmale

- Funktion: Regulier- und Absperrventil
- Einsatz: Pneumatik, Mess- und Regeltechnik, Maschinen- /Apparatebau, für nicht aggressive Medien (s. Beständigkeitsliste PA)
- Besonderes: totraumarme Konstruktion, kompakte Baugrößen

Spécifications

Pression de service (PN): 10 bar
 Température: -20°C à +40°C
 Facteur de sécurité: 1.5 fois

Caractéristiques

- Fonction: vanne de régulation et de retenue
- Application: pneumatique, systèmes de mesure et de régulation, construction de machines et d'appareils, pour des fluides non agressifs (voir liste de résistance PA)
- Particularités: construction sans espace mort, dimensions compactes

Specifications

Working pressure (PN): 10 bar
 Temperature: -20°C to +40°C
 Safety factor: 1.5 times

Characteristics

- Function: regulating and stop valve
- Uses: pneumatics, measurement and control technology, machine and apparatus engineering, for non-aggressive media (see chemical resistance list PA)
- Special: zero static construction, compact sizes

SO NV 31A21E / SO NV 31A21EB



13

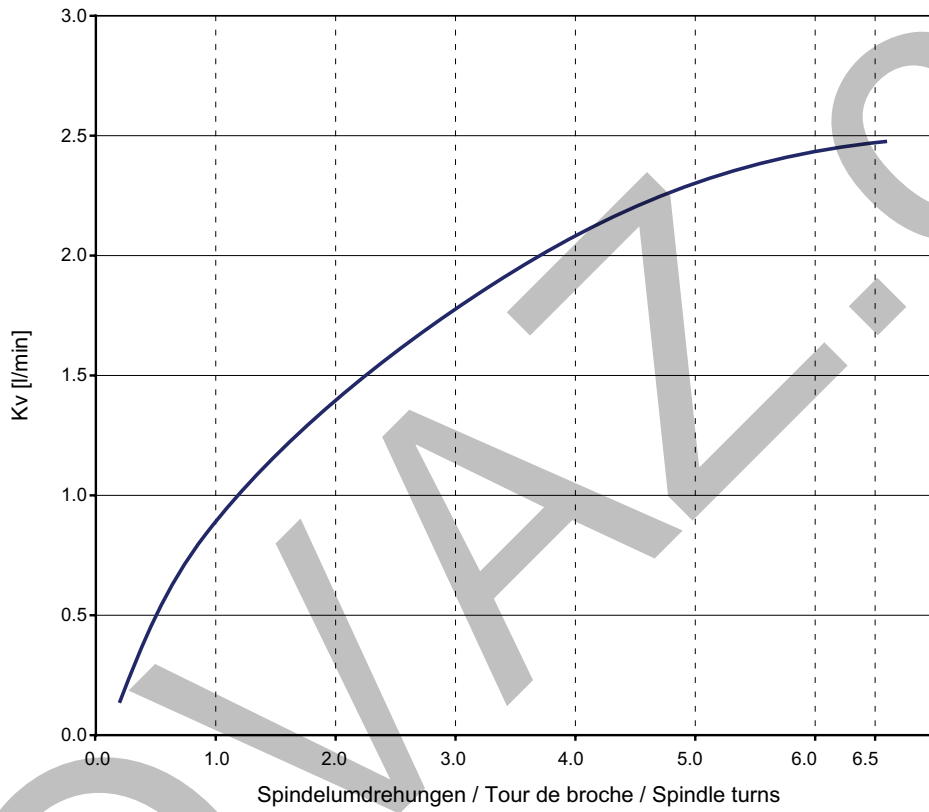

KO

Regulier-Eckventil
Vanne-équerre de réglage
Elbow regulating valve

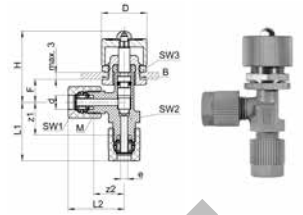

SO NV 31A21E

Type -d	Mat.-Nr.	bar	M	SW1	SW2	SW3	L1	L2	H	F	z1	z2	e	kv	kg/100
SO NV 31A21E-6	138.1500.060	10	10x1.0	12	12	17	26.0	25.0	34.5	10.0	14.5	13.5	3.1	2.5	3.000

D = ø 20 mm
 B = ø 14,5 mm

D = ø 20 mm
 B = ø 14,5 mm

D = ø 20 mm
 B = ø 14,5 mm

Regulier-Eckventil
 mit Einschraubgewinde
Vanne-équerre de réglage
 avec filetage
Elbow regulating valve
 with male adaptor thread

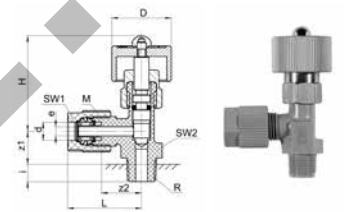

SO NV 31A21EB

Type -d -R	Mat.-Nr.	bar	M	SW1	SW2	L	D	H	i	z1	z2	e	kv	kg/100
SO NV 31A21EB-6-1/8	138.1600.100	10	10x1.0	12	12	25.0	20.0	43.0	3.0	13.5	12.0	3.1	2.5	2.000

R=Rohrgewinde (kegelig)

R=Filetage-gaz BSP (conique)

R=BSP thread (tapered)

d=Rohraussen-ø
 e=kleinste Bohrung
 kv=Kenngröße für das Durchflussverhalten (l/min)
 L=Mass in montiertem Zustand
 H=Ventil geöffnet

d=ø extérieur du tube
 e=ø-min. de passage
 kv=facteur d'écoulement (l/min)
 L=après montage
 H=vanne ouvert

d=tube outside diameter
 e=minimum bore
 kv=flow factor (l/min)
 L=installed length
 H=valve opened

Kegelrückschlagventil

Clapet anti-retour à siège conique

Taper seat non-return valve

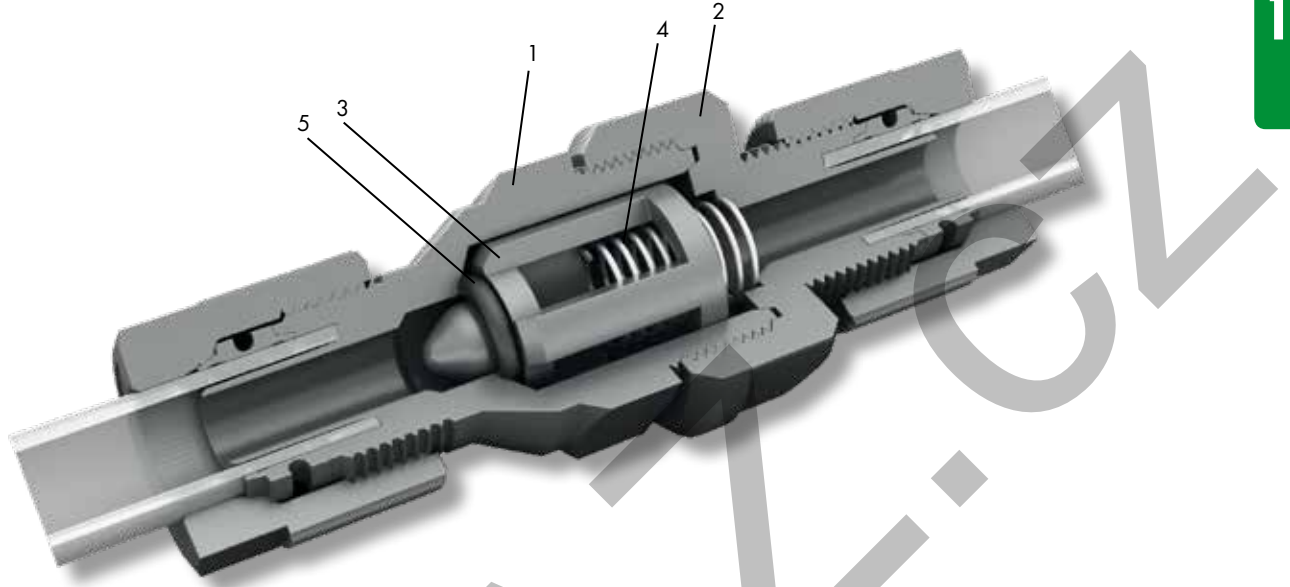
SO CV 33B21
13

Nr. No.	Bezeichnung Désignation Description	Material Matériau Material	Nr. No.	Bezeichnung Désignation Description	Material Matériau Material	Nr. No.	Bezeichnung Désignation Description	Material Matériau Material
1	Ventilsitz Siège du clapet Valve seat	PA	3	Ventilkegel Cône du clapet Valve cone	PA	5*	Dichtung Joint Seal	FKM
2	Ventilmutter Écrou du clapet Valve nut	PA	4	Druckfeder Ressort de compression Compression spring	Hastelloy® 2.4610 C4			

Spezifikationen

Betriebsdruck (PN): 10 bar
 Temperatur: -20°C bis +80°C
 Öffnungsdruck: 0.2 ± 0.1 bar
 Sicherheitsfaktor: 1.5-fach

Merkmale

- Funktion: Rückflussverhinderer
- Einsatz: Medizin, Reinraum und Laborbereich (s. Beständigkeitsliste PA und FKM)
- Besonderes: geringer Druckverlust durch strömungsgünstige Konstruktion

*** Optionen**

- Nr. 5 - Dichtung: EPDM

Spécifications

Pression de service (PN): 10 bar
 Température: -20°C à +80°C
 Pression d'ouverture: 0.2 ± 0.1 bar
 Facteur de sécurité: 1.5 fois

Caractéristiques

- Fonction: clapet anti-retour
- Application: médical, salle blanche et laboratoire (voir liste de résistance PA et FKM)
- Particularités: faible perte de pression grâce à la conception favorisant l'écoulement

*** Options**

- No. 5 - Joint: EPDM

Specifications

Working pressure (PN): 10 bar
 Temperature: -20°C to +80°C
 Opening pressure: 0.2 ± 0.1 bar
 Safety factor: 1.5 times

Characteristics

- Function: check valve
- Uses: medical, clean room and laboratories (see see chemical resistance list PA and FKM)
- Special: low pressure loss due to flow-optimised design

*** Options**

- No. 5 - Seal: EPDM

Durchflussdiagramm

Der Druckabfall nimmt mit zunehmendem Durchfluss überproportional zu.

Courbe de débit

La perte de pression augmente disproportionnellement avec plus de débit.

Flow rate

The pressure drop increases disproportionately with increasing flow rate.

SO CV 33B21

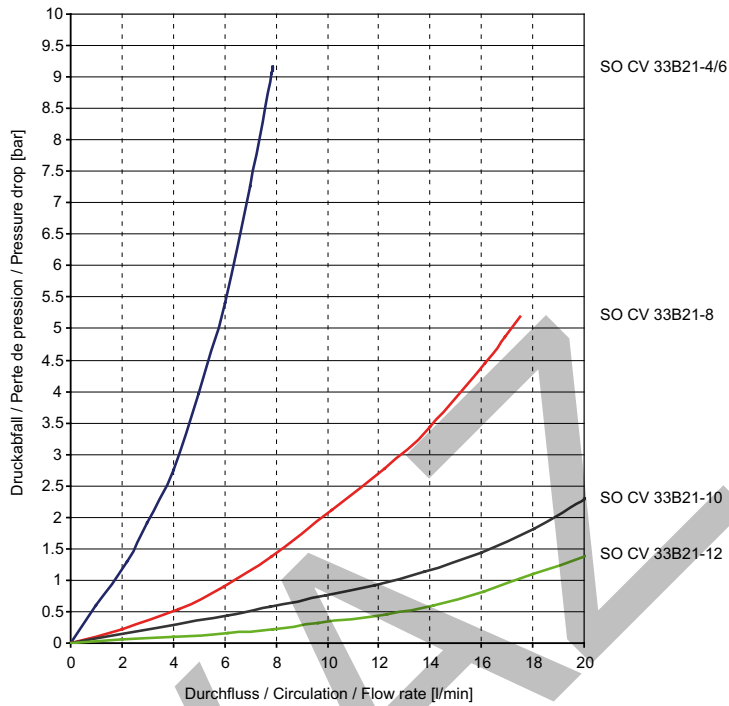

Sonderausführungen

siehe Kapitelübersicht

Exécutions en option

voir aperçu du chapitre

Optional services

see chapter overview

Kegelrückschlagventil

Clapet anti-retour à siège conique

Taper seat non-return valve

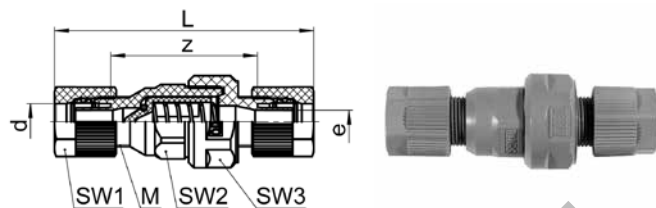

13

SO CV 33B21

Type -d	Mat.-Nr.	bar	M	SW1	SW2	SW3	L	z	e	kg/100
SO CV 33B21-6	138.3010.060	10	10x1.0	12	17	19	56.5	34.0	2.9	1.400
SO CV 33B21-8	138.3010.080	10	12x1.0	14	17	19	61.5	35.5	4.9	1.600
SO CV 33B21-10	138.3010.100	10	14x1.0	17	19	24	69.5	41.0	6.5	2.800
SO CV 33B21-12	138.3010.120	10	16x1.0	19	19	24	74.5	39.0	7.5	3.400

KONVARI

d=Rohraussen-ø
e=kleinste Bohrung
L=Mass in montiertem Zustand

d=ø extérieur du tube
e=ø-min. de passage
L=après montage

d=tube outside diameter
e=minimum bore
L=installed length

Absperrhahn

Vanne à boisseau

Stopcock

SO BV 38A00
SO BV 38A21

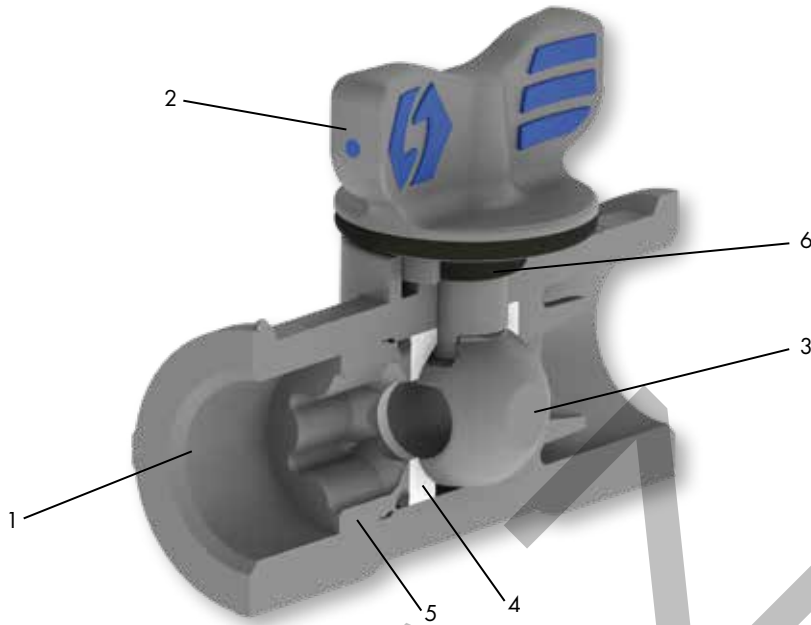

Nr. No. No.	Bezeichnung Désignation Description	Material Matériau Material	Nr. No. No.	Bezeichnung Désignation Description	Material Matériau Material	Nr. No. No.	Bezeichnung Désignation Description	Material Matériau Material
1	Gehäuse Corps Body	PA 6.6	3	Ventilkugel Bille de vanne Valve ball	PA 12	5	Druckschraube Vis de serrage Adjusting screw	PA 6.6
2	Drehgriff Poignée Turning handle	PA 12/TPE	4	Dichtscheibe Rondelle d'étanchéité Sealing washer	PTFE	6	Dichtung Joint Seal	FKM

Spezifikationen

Betriebsdruck (PN): 10 bar
 Temperatur: -20°C bis +40°C
 Sicherheitsfaktor: 1.5-fach

Merkmale

- Funktion: Durchfluss öffnen und absperrn
- Einsatz: Pneumatik, Mess- und Regeltechnik, Maschinen- und Apparatebau; für nicht-aggressive Medien (s. Beständigkeitsliste); vor direkter UV-Bestrahlung schützen
- Besonderes: zwei-Komponenten Drehgriff für rutschfreie Bedienung, totraumarme Konstruktion, kompakte Baugrößen, integrierte Löcher für Befestigung, nachstellbare Dichtung bei Verschleisserscheinungen

Sonderausführungen

siehe Kapitelübersicht

Optionen

Variante: mit Rohranschluss (Version SO BV 38A21)

Spécifications

Pression de service (PN): 10 bar
 Température: -20°C bis +40°C
 Facteur de sécurité: 1.5 fois

Caractéristiques

- Fonction: ouvrir ou fermer le débit
- Application: pneumatique, systèmes de mesure et de régulation, construction de machines et d'appareils; pour des fluides non-agressifs (voir liste de résistance); protéger contre les exposition aux UV directe
- Particularités: poignée bi-composant antidérapant, construction sans espace mort, dimensions compactes, trous intégrés pour montage, joint réglable, quand des signes d'usure apparaissent

Exécutions en option

voir aperçu du chapitre

Options

Autre version: avec raccord du tube (type SO BV 38A21)

Specifications

Working pressure (PN): 10 bar
 Temperature: -20°C bis +40°C
 Safety factor: 1.5 times

Characteristics

- Function: open and shut-off flow
- Uses: pneumatics, measurement and control technology, machine and apparatus engineering; for non-aggressive media (see chemical resistance list); protect against direct UV radiation
- Special: two-piece turning handle for non-slip operation, low dead space design, compact sizes, integrated holes for mounting, adjustable sealing when sign of wear is showing

Optional services

see chapter overview

Options

Other version: with tube connection (type SO BV 38A21)

Absperrhahn

mit Innengewinde

Vanne à boisseau

avec taraudage

Stopcock

with female thread

SO BV 38A00

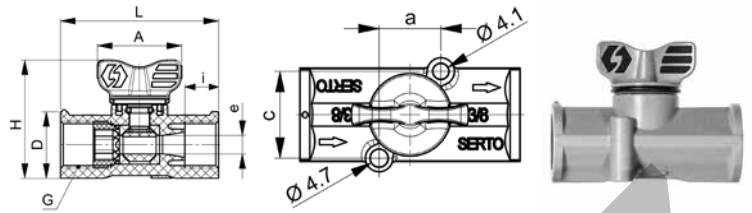

Type -G	Mat.-Nr.	bar	L	D	H	A	a	c	i	kv	e	kg/100
SO BV 38A00-3/8	138.8105.060	10	56.5	24.0	42.0	30.0	15.8	22.3	12.0	22.0	6.6	2.120

Absperrhahn

Vanne à boisseau

Stopcock

SO BV 38A21

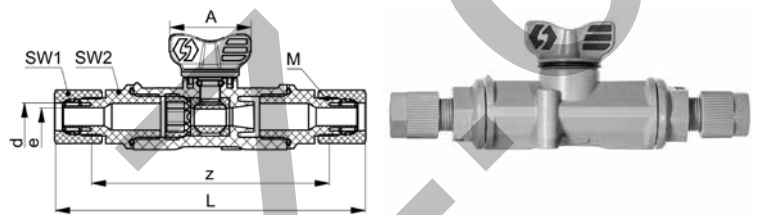

Type -d	Mat.-Nr.	bar	M	SW1	SW2	L	A	z	e	kg/100
SO BV 38A21-6	138.8115.060	10	10x1.0	12	17	110.0	30.0	89.0	2.8	3.440
SO BV 38A21-8	138.8115.080	10	12x1.0	14	17	114.0	30.0	89.0	4.8	3.570
SO BV 38A21-10	138.8115.100	10	14x1.0	17	17	114.0	30.0	88.0	6.6	3.860
SO BV 38A21-12	138.8115.120	10	16x1.0	19	17	120.0	30.0	86.0	6.6	4.240

d=Rohrassen-ø
 e=kleinste Bohrung
 kv=Kenngröße für das Durchflussverhalten (l/min)
 L=Mass in montiertem Zustand

d=ø extérieur du tube
 e=ø-min. de passage
 kv=facteur d'écoulement (l/min)
 L=après montage

d=tube outside diameter
 e=minimum bore
 kv=flow factor (l/min)
 L=installed length

Schwenkverschraubung

mit Drossel-Ventil

Coude banjo

avec limiteur de débit

Single banjo

with throttle valve

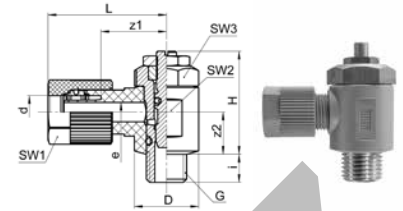
SO 37621

Type -d-G	Mat.-Nr.	bar	M	SW1	SW2	SW3	L	D	H	i	z1	z2	e	kv	kg/100
G=Rohrgewinde (zylindrisch)				G=Filetage-gaz BSP (cylindrique)							G=BSP thread (parallel)				
SO 37621-6-1/8	168.7600.100	10	10x1.0	12	14	14	27.5	16.0	25.0	7.0	16.5	10.5	2.8	3.0	2.100
SO 37621-6-1/4	168.7600.110	10	10x1.0	12	19	19	27.5	20.0	32.0	9.0	16.5	12.5	2.8	6.0	4.400
SO 37621-8-1/8	168.7600.160	10	12x1.0	14	14	14	29.5	16.0	25.5	7.0	16.5	10.5	4.8	3.0	2.800
SO 37621-8-1/4	168.7600.170	10	12x1.0	14	19	19	29.5	20.0	30.5	9.0	16.5	12.5	4.8	6.0	4.500
SO 37621-10-1/4	168.7600.270	10	14x1.0	17	19	19	30.0	20.0	30.5	9.0	16.0	12.5	6.6	6.0	4.600

Dieses Drossel-Ventil dient zur Regulierung von Luftströmen in beiden Richtungen. Die Kombination von Verschraubung und Drossel-Ventil erlaubt den Anbau direkt an einen passenden Zylinder.

Die Spindelfixierung mittels Kontermutter garantiert, dass sich die Spindel auch bei Vibration nicht verstellt.

Technische Hinweise:

Körper, Anschlussmutter: PA 6.6
O-Ringe: NBR
Hohlschraube, Ventileinsatz: Messing

Ce limiteur de débit sert au réglage d'écoulements d'air dans les deux sens. La combinaison raccord avec limiteur de débit est spécialement destinée au montage sur un cylindre approprié.

La fixation de la broche à l'aide d'un contre-écrou garantit la stabilité du réglage même en cas de vibrations.

Données techniques:

Corps, écrou de raccord: PA 6.6
Joints toriques: NBR
Vis banjo, parties de valve: laiton

This throttle valve serves to regulate air flow in both directions. The combination of union and throttle valve permits direct fitting to a matching cylinder.

The spindle fixation via counter nut assures that the spindle can not shift, even due to vibration.

Technical notes:

Body, union nut: PA 6.6
O-rings: NBR
Hollow screw, valve parts: brass

Schwenkverschraubung

mit Drossel-Rückschlagventil

Coude banjo

avec clapet anti-retour limiteur de débit

Single banjo

with throttle non-return valve

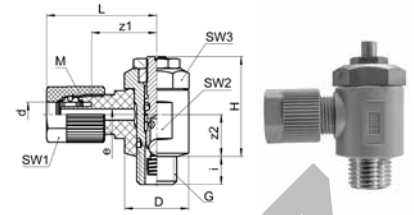
SO 37721

13

Type -d-G	Mat.-Nr.	bar	M	SW1	SW2	SW3	L	D	H	i	z1	z2	e	kv	kg/100
G=Rohrgewinde (zylindrisch)															
				G=Filetage-gaz BSP (cylindrique)											
				G=BSP thread (parallel)											
SO 37721-6-1/8	168.7700.100	10	10x1.0	12	14	14	27.5	16.0	25.0	7.0	16.5	10.5	2.8	3.0	2.100
SO 37721-6-1/4	168.7700.110	10	10x1.0	12	19	19	27.5	20.0	32.0	9.0	16.5	12.5	2.8	6.0	4.300
SO 37721-8-1/8	168.7700.160	10	12x1.0	14	14	14	29.5	16.0	25.5	7.0	16.5	10.5	4.8	3.0	2.400
SO 37721-8-1/4	168.7700.170	10	12x1.0	14	19	19	29.5	20.0	30.5	9.0	16.5	12.5	4.8	6.0	4.500
SO 37721-10-1/4	168.7700.270	10	14x1.0	17	19	19	30.0	20.0	30.5	9.0	16.0	12.5	6.6	6.0	4.600

Dieses Drossel-Rückschlagventil dient zur Regulierung von Luftströmen in der Anschlussrichtung. Die Kombination von Verschraubung und Ventil erlaubt den Anbau direkt an einen passenden Zylinder. Die Spindelfixierung mittels Kontermutter garantiert, dass sich die Spindel auch bei Vibration nicht verstellt.

Technische Hinweise:

Körper, Anschlussmutter: PA 6.6
O-Ringe: NBR
Hohlschraube, Ventileinsatz: Messing

Ce clapet anti-retour limiteur de débit sert au réglage d'écoulements d'air dans la sens de connexion. La combinaison raccord avec clapet est spécialement destinée au montage sur un cylindre approprié. La fixation de la broche à l'aide d'un contre-écrou garantit la stabilité du réglage même en cas de vibrations.

Données techniques:

Corps, écrou de raccord: PA 6.6
Joints toriques: NBR
Vis banjo, parties du clapet: laiton

This throttle non-return valve serves to regulate air flow in the direction of connection. The combination of union and valve permits direct fitting to a matching cylinder. The spindle fixation via counter nut assures that the spindle can not shift, even due to vibration.

Technical notes:

Body, union nut: PA 6.6
O-rings: NBR
Hollow screw, valve parts: brass

d=Rohrassens-ø / mit Wandung 1 mm
e=kleinste Bohrung
kv=Kenngröße für das Durchflussverhalten (l/min)
L=Mass in montiertem Zustand

d=ø extérieur du tube / avec paroi de 1 mm
e=ø-min. de passage
kv=facteur d'écoulement (l/min)
L=après montage

d=tube outside diameter / with wall thickness 1 mm
e=minimum bore
kv=flow factor (l/min)
L=installed length

Nicht nur sauber – sondern rein

Vor allem in der Halbleiterindustrie, in Anwendungen mit reinem Sauerstoff, Farben und Lacken müssen Verschraubungen öl- und fettfrei sein. Dafür durchlaufen die Teile eine Reinigungsanlage und werden im SERTO-Reinraum der ISO Klasse 8 montiert und einzeln verpackt.

Es gibt Einsatzgebiete für SERTO-Verschraubungen und Ventile, die hohen Reinheitsanforderungen unterliegen. Seit Jahren bietet SERTO dafür die Optionen US (im Ultraschallbad gereinigt, ungeschmiert), OX (im Ultraschallbad gereinigt, geschmiert für Sauerstoffsysteme) und SI (im Ultraschallbad gereinigt, silikonfrei geschmiert für Verwendung in Verbindung mit Farben und Lacken) an.

Pas seulement propre – mais pur

Pour certaines applications comme l'industrie des semi-conducteurs, les secteurs ayant recours à l'oxygène pur, aux peintures et aux laques, les raccords doivent être exempts d'huile et de graisse. Les pièces passent donc par une station de nettoyage avant d'être montées et conditionnées individuellement en salle blanche SERTO conforme à la catégorie 8 de la norme ISO.

Les raccords et vannes SERTO sont soumis à des exigences drastiques en matière de propreté en fonction de leur domaine d'utilisation. Depuis des années, SERTO propose à cet effet les options US (nettoyage par ultrasons, sans lubrification), OX (nettoyage par ultrasons, puis lubrification spéciale pour utilisation avec oxygène) et SI (nettoyage par ultrasons, puis lubrification spéciale sans silicone pour une utilisation avec des couleurs et des laques).

Not just clean – but pure

Above all in the semiconductor industry, for applications with pure oxygen, paints and lacquers, tube unions must be free of oil and grease. To ensure this, the components pass through a cleaning system and are assembled and individually packed in the SERTO ISO Class 8 clean room.

Some fields of application for SERTO tube unions and valves are subject to high cleanliness requirements. For many years, SERTO has provided the options US (cleaned with ultrasound and not lubricated), OX (cleaned with ultrasound for use in oxygen systems) and SI (cleaned with ultrasound, silicon-free for use in combination with paints and lacquers).



**Schnellkupplungen
Metall**

Messing, Edelstahl, Stahl

**Coupleurs rapides
en métal**

Laiton, acier inoxydable,
acier

**Quick-disconnect
couplings in metal**

Brass, stainless steel, steel



Seite/Page/Page

Seite/Page/Page

Seite/Page/Page

**Schnellkupplungen MS
Coupleur rapide laiton
Quick couplings brass**

Serie 21 "Stecker"
Série 21 "embout"
Series 21 "nipple"

597-599



Serie H "Kuppler"
Série H "coupleur"
Series H "coupler"

617-619



Serie EA/E "Kuppler"
Série EA/E "coupleur"
Series EA/E "coupler"

583-584



Serie 22 "Kuppler"
Série 22 "coupleur"
Series 22 "coupler"

600-601



Serie H "Stecker"
Série H "embout"
Series H "nipple"

620



Serie EA/E "Stecker"
Série EA/E "embout"
Series EA/E "nipple"

584



Serie 22 "Stecker"
Série 22 "embout"
Series 22 "nipple"

602



Serie 25 "Kuppler"
Série 25 "coupleur"
Series 25 "coupler"

621-622



Serie H "Kuppler"
Série H "coupleur"
Series H "coupler"

585-587



**Schnellkupplungen Inox
Coupleur rapide inox
Quick couplings inox**

Serie 25 "Stecker"
Série 25 "embout"
Series 25 "nipple"

622



Serie H "Stecker"
Série H "embout"
Series H "nipple"

588



Serie 50 "Kuppler"
Série 50 "coupleur"
Series 50 "coupler"

603-607



**Zubehör
Accessoires
Accessories**

Serie 20 "Kuppler"
Série 20 "coupleur"
Series 20 "coupler"

589-592



Serie 50 "Stecker"
Série 50 "coupleur"
Series 50 "nipple"

607-608



Schutzkappe / Schutzstecker
Capuchon de protection / embout
Protection cap / plug

623



Serie 20 "Stecker"
Série 20 "embout"
Series 20 "nipple"

592-593



Serie 51 "Kuppler"
Série 51 "coupleur"
Series 51 "coupler"

609-612



Dichtungsset
Set de joints
Gasket set

PDCP

623



Serie 21 "Kuppler"
Série 21 "coupleur"
Series 21 "coupler"

594-597



Serie 51 "Stecker"
Série 51 "embout"
Series 51 "nipple"

613-616



H...-56-9

Materialien Serie EA, E

- Kuppler und Stecker: Messing
- Dichtungen: NBR (Standard)
EPDM/FKM lieferbar, andere auf Anfrage

Nennweite

1/4" - 1"; DN6 - DN25

Betriebstemperatur

NBR: -15°C bis +80°C
EPDM: -40°C bis +160°C
FKM: -20°C bis +200°C

Betriebsdruck

65 bis 200 bar bei +23°C

Kupplungsfunktionen

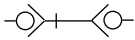

beidseitig absperrend
Kuppler absperrend B-VEAC/B-VEC
Stecker absperrend B-VEAN/B-VEN

Eigenschaften

- exzellente Dichteigenschaften auch bei hohen Temperaturen
- strömungsgünstige Ventilkonstruktion
- Hochvakuum bis 10⁻⁷ mbar

Merkmale

- Einsatz: Vakuumpumpen, Autoklaven, Dampfsysteme
- Medien: Flüssigkeiten, Gase

Durchflussleistung

Matériaux séries EA, E

- Coupleur et embout: laiton
- Joints: NBR (standard)
EPDM/FKM disponible, autres sur demande

Largeur nominale

1/4" - 1"; DN6 - DN25

Plage de température

NBR: -15°C à +80°C
EPDM: -40°C à +160°C
FKM: -20°C à +200°C

Pression de service

65 à 200 bar à +23°C

Fonctions d'accouplement

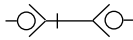

obturant dans les deux sens
coupleur obturant B-VEAC/B-VEC
embout obturant B-VEAN/B-VEN

Propriétés

- excellents performances d'étanchéité même à température élevée
- construction de la soupape favorable à l'écoulement
- vide élevé jusqu'à 10⁻⁷ mbar

Caractéristiques

- Application: pompes à vide, autoclaves, systèmes à vapeur
- Médium: fluides, gaz

Débit

Materials series EA, E

- Coupler and nipple: brass
- Seals: NBR (standard)
EPDM/FKM available, others on request

Nominal bore

1/4" - 1"; DN6 - DN25

Temperature range

NBR: -15°C to +80°C
EPDM: -40°C to +160°C
FKM: -20°C to +200°C

Working pressure

65 to 200 bar at +23°C

Coupling functions

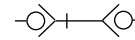

double-sided shut-off
coupler shut-off B-VEAC/B-VEC
nipple shut-off B-VEAN/B-VEN

Properties

- excellent sealing properties even at high temperatures
- flow-optimised valve design
- high vacuum up to 10⁻⁷ mbar

Characteristics

- Uses: vacuum pumps, autoclaves, steam systems
- Media: fluids, gases

Flow capacity

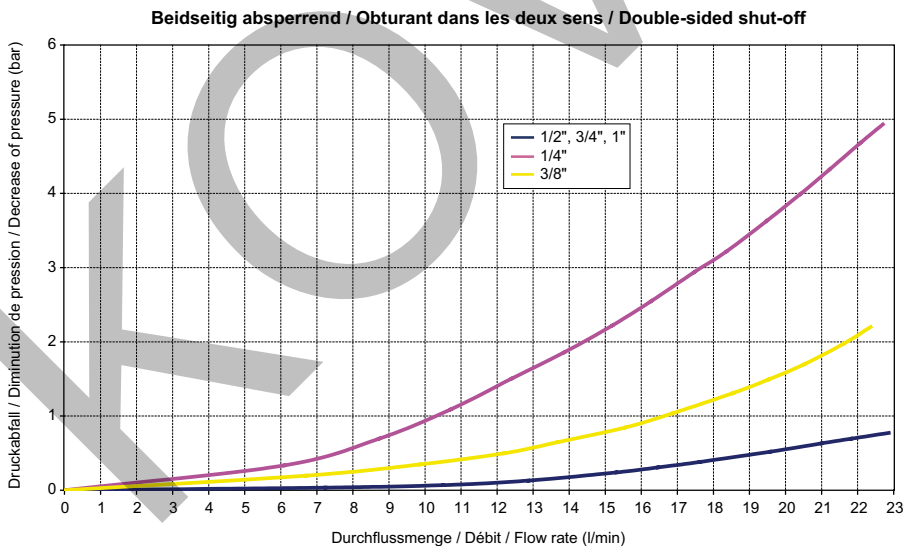

Kuppler mit Innengewinde

absperrend

Coupleur avec taraudage

obturant

Coupler with female thread

shut-off

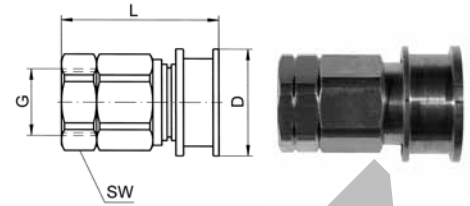

B-VEAC

Type -G	Mat.-Nr.	bar	SW	L	D	kg/100
G=Rohrgewinde (zylindrisch)	G=Filetage-gaz BSP (cylindrique)			G=BSP thread (parallel)		
B-VEAC4-G $\frac{1}{4}$ i	YBD.EA42.1040	100	22	42.0	28.8	10.800
B-VEAC6-G $\frac{3}{8}$ i	YBD.EA42.1060	100	25	48.0	33.3	15.700
B-VEAC8-G $\frac{1}{2}$ i	YBD.EA42.1080	100	30	53.0	36.5	19.000
B-VEAC12-G $\frac{3}{4}$ i	YBD.EA42.1090	100	38	61.5	47.6	21.000
B-VEAC16-G1i	YBD.OE42.1100	35	47	67.8	55.5	33.800

Stecker mit Innengewinde

absperrend

Embout avec taraudage

obturant

Nipple with female thread

shut-off

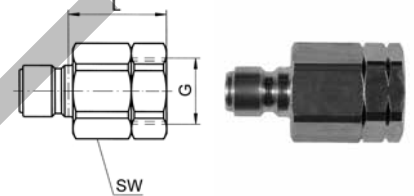

B-VEAN

Type -G	Mat.-Nr.	bar	SW	L	kg/100
G=Rohrgewinde (zylindrisch)	G=Filetage-gaz BSP (cylindrique)			G=BSP thread (parallel)	
B-VEAN4-G $\frac{1}{4}$ i	YBD.EA44.1040	100	22	25.4	7.000
B-VEAN6-G $\frac{3}{8}$ i	YBD.EA44.1060	100	25	29.0	10.500
B-VEAN8-G $\frac{1}{2}$ i	YBD.EA44.1080	100	30	34.5	15.500
B-VEAN12-G $\frac{3}{4}$ i	YBD.EA44.1090	100	38	35.6	27.000
B-VEAN16-G1i	YBD.OE44.1100	35	47	43.4	45.300

Kupplungen MS Serie H

Materialien Serie H

- Kuppler und Stecker: Messing
- Dichtungen: NBR (Standard)
FKM lieferbar, andere auf Anfrage

Nennweite

1/4" - 1"; DN6 - DN25

Betriebstemperatur

NBR: -15°C bis +80°C
FKM: -20°C bis +200°C

Betriebsdruck

125 bis 280 bar bei +23°C

Kupplungsfunktionen

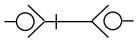

beidseitig absperrend
Kuppler absperrend B-VHC
Stecker absperrend B-VHN

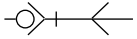

einseitig absperrend
Kuppler absperrend B-VHC
Stecker nicht absperrend B-PHN

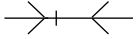

nicht absperrend
Kuppler nicht absperrend B-PHC
Stecker nicht absperrend B-PHN

Eigenschaften

- schnelle und einfache Bedienung
- spezielles "Jet-Stream" Ventil sorgt für geringen Strömungswiderstand
- gleichmäßiger Durchfluss
- sehr niedriger Druckverlust

Merkmale

- Einsatz: Hydraulik, Pneumatik
- Medien: Flüssigkeiten, Gase

Durchflussleistung

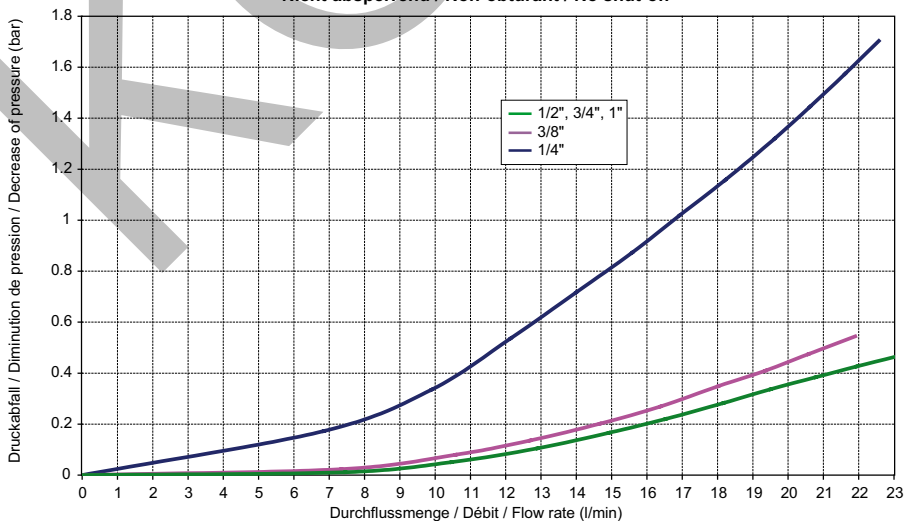

Coupleurs laiton série H

Matériaux séries H

- Coupleur et embout: laiton
- Joints: NBR (standard)
FKM disponible, autres sur demande

Largeur nominale

1/4" - 1"; DN6 - DN25

Plage de température

NBR: -15°C à +80°C
FKM: -20°C à +200°C

Pression de service

125 à 280 bar à +23°C

Fonctions d'accouplement

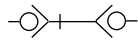

obturant dans les deux sens
coupleur obturant B-VHC
embout obturant B-VHN

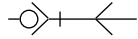

obturant dans un sens
coupleur obturant B-VHC
embout non-obturant B-PHN

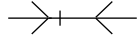

non-obturant
coupleur non-obturant B-PHC
embout non-obturant B-PHN

Propriétés

- utilisation simple et rapide
- soupape spécial "jet-stream" assure une faible résistance à l'écoulement
- débit constant
- très peu de pertes de pression

Caractéristiques

- Application: hydraulique, pneumatique
- Médium: fluides, gaz

Débit

Couplings brass series H

Materials series H

- Coupler and nipple: brass
- Seals: NBR (standard)
FKM available, others on request

Nominal bore

1/4" - 1"; DN6 - DN25

Temperature range

NBR: -15°C to +80°C
FKM: -20°C to +200°C

Working pressure

125 to 280 bar at +23°C

Coupling functions

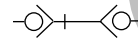

double-sided shut-off
coupler shut-off B-VHC
nipple shut-off B-VHN

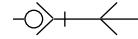

one-sided shut-off
coupler shut-off B-VHC
nipple no shut-off B-PHN



no shut-off
coupler no shut-off B-PHC
nipple no shut-off B-PHN

Properties

- fast and easy to use
- special "jet stream" valve for low flow resistance
- steady flow
- very little pressure loss

Characteristics

- Uses: hydraulic and pneumatic systems
- Media: fluids, gases

Flow capacity



Einseitig absperrend / Obturant dans un sens / One-sided shut-off

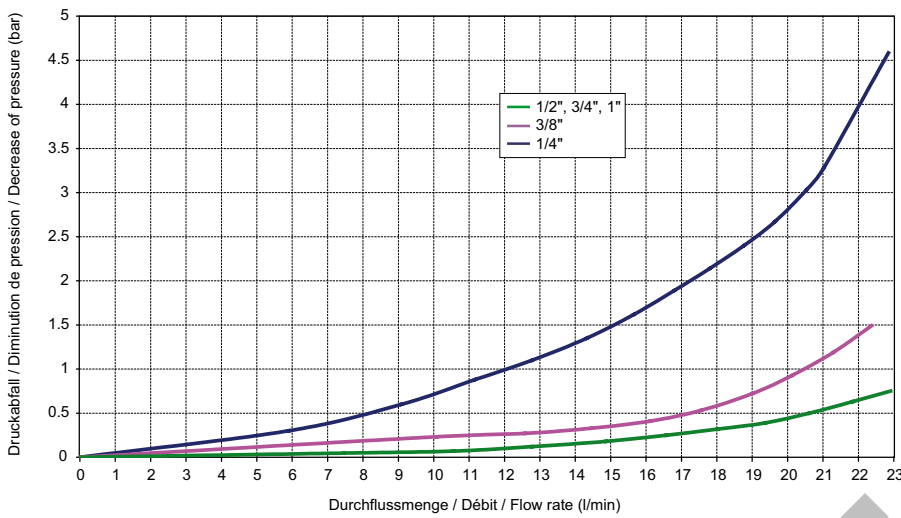

Beidseitig absperrend / Obturant dans les deux sens / Double-sided shut-off

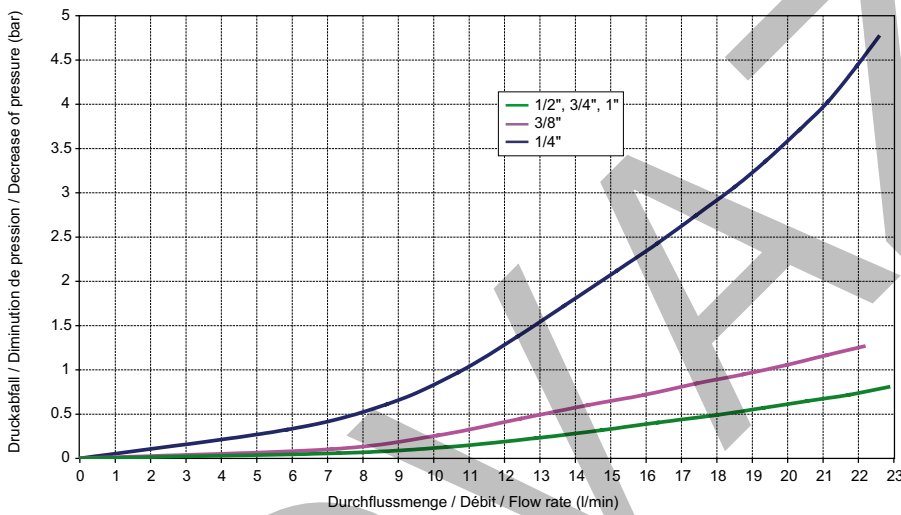

Lieferhinweis

Kupplungen können aus Sechskantmaterial oder aus Rundmaterial mit zwei gefrästen Flächen hergestellt sein.

Note à la livraison

Les accouplements peuvent être réalisés en matériau hexagonal ou en matériau rond avec deux surfaces fraisées.

Note on delivery

Couplings can be made of hexagonal material or of round material with two milled sides.

Kuppler mit Innengewinde

nicht absperrend

Coupleur avec taraudage

non-obturant

Coupler with female thread

no shut-off

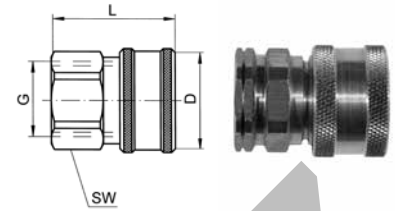

B-PHC

Type -G	Mat.-Nr.	bar	SW	L	D	kg/100
G=Rohrgewinde (zylindrisch)	G=Filetage-gaz BSP (cylindrique)			G=BSP thread (parallel)		
B-PHC4-G $\frac{1}{4}$ i	YBD.OH41.1040	280	22	34.0	25.4	7.700
B-PHC6-G $\frac{3}{8}$ i	YBD.OH41.1060	280	25	38.1	30.2	11.500
B-PHC8-G $\frac{1}{2}$ i	YBD.OH41.1080	280	30	41.2	35.3	15.500
B-PHC12-G $\frac{3}{4}$ i	YBD.OH41.1090	245	38	48.5	41.4	25.000
B-PHC16-G1i	YBD.OH41.1100	210	47	52.6	50.8	41.800

14

Kuppler mit Innengewinde

absperrend

Coupleur avec taraudage

obturant

Coupler with female thread

shut-off

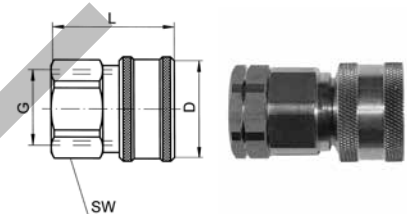

B-VHC

Type -G	Mat.-Nr.	bar	SW	L	D	kg/100
G=Rohrgewinde (zylindrisch)	G=Filetage-gaz BSP (cylindrique)			G=BSP thread (parallel)		
B-VHC4-G $\frac{1}{4}$ i	YBD.OH42.1040	155	22	41.9	25.4	10.700
B-VHC6-G $\frac{3}{8}$ i	YBD.OH42.1060	155	25	48.3	30.2	15.600
B-VHC8-G $\frac{1}{2}$ i	YBD.OH42.1080	140	30	53.1	35.3	21.800
B-VHC12-G $\frac{3}{4}$ i	YBD.OH42.1090	140	38	61.5	41.4	37.000
B-VHC16-G1i	YBD.OH42.1100	125	47	67.8	50.8	60.700

Kuppler mit Innengewinde NPT

absperrend

Coupleur avec taraudage NPT

obturant

Coupler with female thread NPT

shut-off

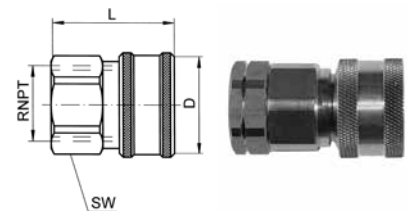

B-VHC-NPT

Type -RNPT	Mat.-Nr.	bar	SW	L	D	kg/100
RNPT=NPT Gewinde	RNPT=Filetage NPT			RNPT=NPT thread		
B-VHC4- $\frac{1}{4}$ NPSi	YBD.OH42.2040	155	22	41.9	25.4	9.400

Stecker mit Innengewinde

nicht absperrend

Embout avec taraudage

non-obturant

Nipple with female thread

no shut-off

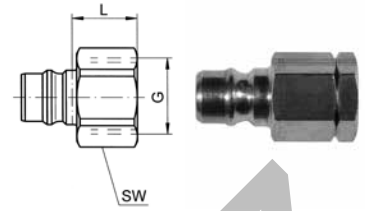

B-PHN

Type -G	Mat.-Nr.	bar	SW	L	kg/100
G=Rohrgewinde (zylindrisch)	G=Filetage-gaz BSP (cylindrique)			G=BSP thread (parallel)	
B-PHN4-G $\frac{1}{4}$ i	YBD.OH43.1040	280	16	18.5	2.500
B-PHN6-G $\frac{3}{8}$ i	YBD.OH43.1060	280	20	20.3	3.800
B-PHN8-G $\frac{1}{2}$ i	YBD.OH43.1080	280	25	25.4	7.200
B-PHN12-G $\frac{3}{4}$ i	YBD.OH43.1090	245	30	26.1	10.200
B-PHN16-G1i	YBD.OH43.1100	210	38	30.2	18.000

Stecker mit Innengewinde

absperrend

Embout avec taraudage

obturant

Nipple with female thread

shut-off

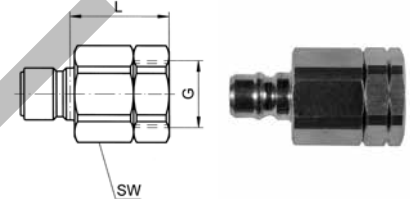

B-VHN

Type -G	Mat.-Nr.	bar	SW	L	kg/100
G=Rohrgewinde (zylindrisch)	G=Filetage-gaz BSP (cylindrique)			G=BSP thread (parallel)	
B-VHN4-G $\frac{1}{4}$ i	YBD.OH44.1040	155	22	25.4	7.000
B-VHN6-G $\frac{3}{8}$ i	YBD.OH44.1060	155	25	28.4	9.850
B-VHN8-G $\frac{1}{2}$ i	YBD.OH44.1080	140	30	32.0	15.300
B-VHN12-G $\frac{3}{4}$ i	YBD.OH44.1090	140	38	35.6	26.000
B-VHN16-G1i	YBD.OH44.1100	125	47	41.7	44.400

Kupplungen MS Serie 20

Coupleurs laiton série 20

Couplings brass series 20

Materialien Serie 20

- Kuppler und Stecker: Messing vernickelt
- Feder: Inox 1.4310
- Kugeln: Inox 1.4034
- Dichtungen: NBR

Nennweite

2.7 = 6 mm²

Betriebstemperatur

-20°C bis +100°C
(abhängig vom Durchflussmedium)

Betriebsdruck

35 bar bei +23°C
maximaler statischer Betriebsdruck (ohne Pulsation) bei min. 4-facher statischer Sicherheit

Kupplungsfunktionen

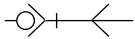

einseitig absperrend
Kuppler absperrend <CO KA...>
Stecker nicht absperrend <CO T...>

Eigenschaften

- sehr hoher Durchfluss
- Einhandbedienung
- sehr kleine Baumasse

Merkmale

- Funktion: Kleinst-Industriekupplung
- Einsatz: Mini-Pneumatik, Mess- und Steuerleitungen, Chemie, Pharmazie
- Medien: Flüssigkeiten, Gase

Durchflussleistung

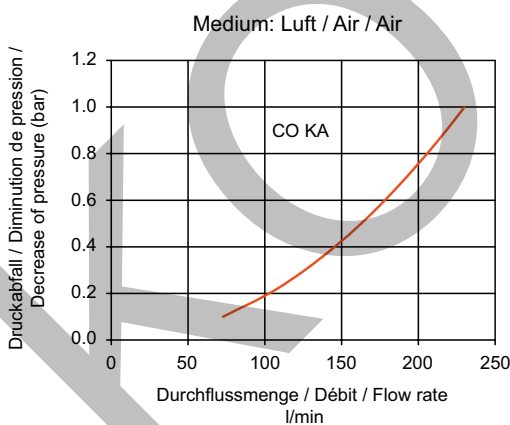

Matériaux séries 20

- Coupleur et embout: laiton nickelé
- Ressort: inox 1.4310
- Billes: inox 1.4034
- Joints: NBR

Largeur nominale

2.7 = 6 mm²

Plage de température

-20°C à +100°C
(en fonction du fluide d'écoulement)

Pression de service

35 bar à +23°C
pression de service statique max. (sans pulsation) avec un facteur de sécurité statique min. de 4

Fonctions d'accouplement

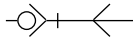

obturant dans un sens
coupleur obturant <CO KA...>
embout non-obturant <CO T...>

Propriétés

- un très grand écoulement
- utilisation à une seule main
- de très petites dimensions

Caractéristiques

- Fonction: le plus petit raccord industriel
- Application: pneumatique miniaturisée, conduites de mesure et de commande, technologie médicale et pharmaceutique
- Médium: fluides, gaz

Débit

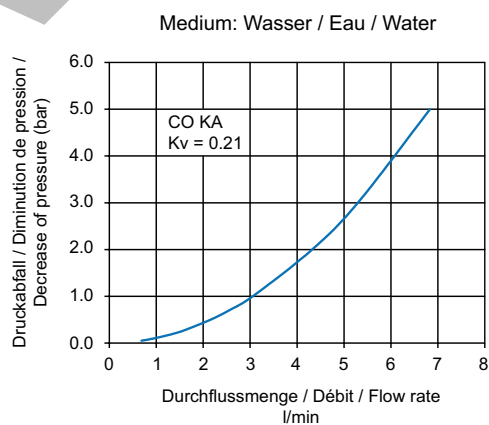

Materials series 20

- Coupler and nipple: brass nickel plated
- Springs, inox 1.4310
- Balls: inox 1.4034
- Seals: NBR

Nominal bore

2.7 = 6 mm²

Temperature range

-20°C to +100°C
(depending on medium used)

Working pressure

35 bar at +23°C
maximum static operating pressure (without pulsation) at min. static safety of 4

Coupling functions

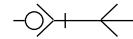

one-sided shut-off
coupler shut-off <CO KA...>
nipple no shut-off <CO T...>

Properties

- very high flow rate
- one-handed operation
- very compact dimensions

Characteristics

- Function: miniature industrial coupling
- Uses: miniature pneumatic systems, gauge lines and servo-lines, medical and pharmaceutical technology
- Media: fluids, gases

Flow capacity



Kuppler mit Schlauchtülle

absperrend

Coupleur avec douille cannelée pour tuyau

obturant

Coupler with hose nozzle

shut-off

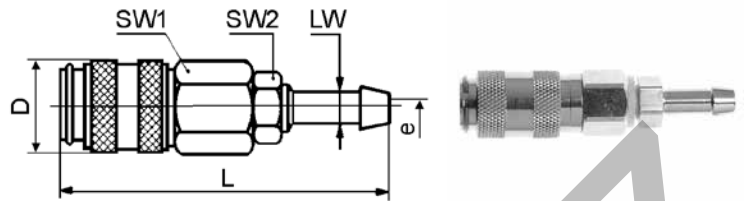

CO KA 201

Type -LW	Mat.-Nr.	bar	SW1	SW2	L	D	e	kg/100
CO KA 201-LW 2 N	334.2040.020	35	9	7	38.0	10.0	1.5	1.200
CO KA 201-LW 2,5 N	334.2040.025	35	9	7	39.0	10.0	2.0	1.200
CO KA 201-LW 3 N	334.2040.030	35	9	7	40.0	10.0	2.0	1.200
CO KA 201-LW 4 N	334.2040.040	35	9	7	41.0	10.0	2.7	1.300

Kuppler mit Innengewinde

absperrend

Coupleur avec taraudage

obturant

Coupler with female thread

shut-off

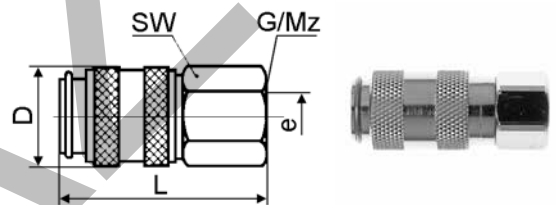

CO KA 202

Type -G / -Mz	Mat.-Nr.	bar	SW	L	D	e	kg/100
G=Rohrgewinde (zylindrisch)	G=Filetage-gaz BSP (cylindrique)				G=BSP thread (parallel)		
Mz=metrisches Gewinde (zylindrisch)	Mz=Filetage métrique (cylindrique)				Mz=Metric thread (parallel)		
CO KA 202-G $\frac{1}{8}$ N	334.2060.020	35	12	28.0	10.0	2.7	1.400
CO KA 202-M5 N	334.2070.080	35	9	26.0	10.0	2.7	1.000

Kuppler mit Aussengewinde

absperrend

Coupleur avec filetage

obturant

Coupler with male thread

shut-off

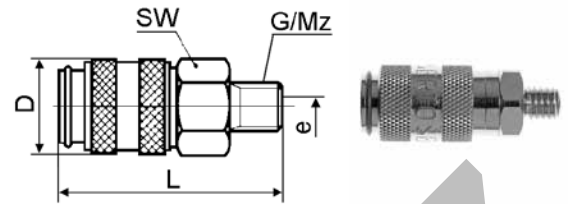

CO KA 203

Type -G / -Mz	Mat.-Nr.	bar	SW	L	D	e	kg/100
G=Rohrgewinde (zylindrisch)			G=Filetage-gaz BSP (cylindrique)			G=BSP thread (parallel)	
Mz=metrisches Gewinde (zylindrisch)			Mz=Filetage métrique (cylindrique)			Mz=Metric thread (parallel)	
CO KA 203-G $\frac{1}{8}$ N	334.2080.020	35	11	28.0	10.0	2.7	1.000
CO KA 203-M4 N	334.2090.060	35	9	26.0	10.0	2.7	0.900
CO KA 203-M5 N	334.2090.080	35	9	26.0	10.0	2.7	0.900
CO KA 203-M8x1 N	334.2090.120	35	11	28.0	10.0	2.7	1.300

Teile können mit einer PVC-Dichtscheibe ausgestattet sein.

Les pièces peuvent être équipées d'une rondelle d'étanchéité en PVC.

Parts may be equipped with a PVC sealing washer.

Kuppler mit SERTO-Anschluss

absperrend

Coupleur avec connexion SERTO

obturant

Coupler with SERTO connection

shut-off

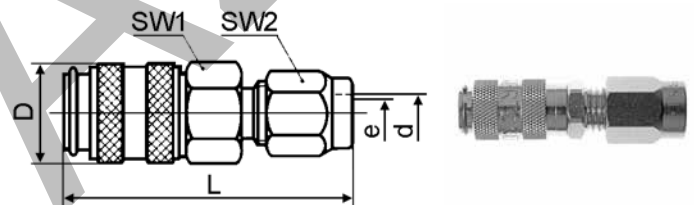

CO KA 204

Type -d	Mat.-Nr.	bar	SW1	SW2	L	D	e	kg/100
CO KA 204-4 N	334.2110.040	35	6	10	36.0	10.0	2.7	1.550
CO KA 204-5 N	334.2110.050	35	6	10	36.0	10.0	2.7	1.600

 d=Rohraussen- \emptyset
 LW=Rohrinnen- \emptyset
 e=kleinste Bohrung

 d= \emptyset extérieur du tube
 LW= \emptyset intérieur du tube
 e= \emptyset -min. de passage

 d=tube outside diameter
 LW=tube inside diameter
 e=minimum bore

Kuppler in Schottausführung mit SERTO-Anschluss

absperrend

Coupleur traversée de cloison avec connexion SERTO

obturant

Panel mount coupler with SERTO connection

shut-off

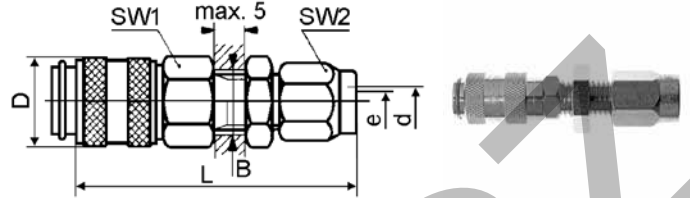

CO KA 205

Type-d	Mat.-Nr.	bar	SW1	SW2	L	D	B	e	kg/100
CO KA 205-2 N	334.2140.020	35	9	8	37.0	10.0	6.5	2.7	1.400
CO KA 205-3 N	334.2140.030	35	9	8	38.0	10.0	6.5	2.7	1.450
CO KA 205-4 N	334.2140.040	35	9	10	42.0	10.0	8.5	2.7	1.900
CO KA 205-5 N	334.2140.050	35	9	10	42.0	10.0	8.5	2.7	1.900

Stecker mit Schlauchtülle

nicht absperrend

Embout avec douille cannelée pour tuyau

non-obturant

Nipple with hose nozzle

no shut-off

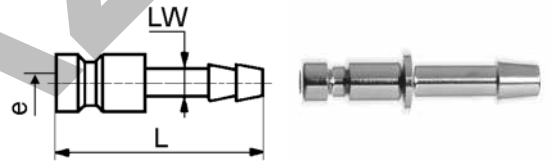

COT 201

Type-LW	Mat.-Nr.	bar	L	e	kg/100
COT 201-LW 3 N	334.2250.030	35	24.0	2.0	0.250
COT 201-LW 4 N	334.2250.040	35	24.0	2.7	0.350

Stecker mit Innengewinde

nicht absperrend

Embout avec taraudage

non-obturant

Nipple with female thread

no shut-off

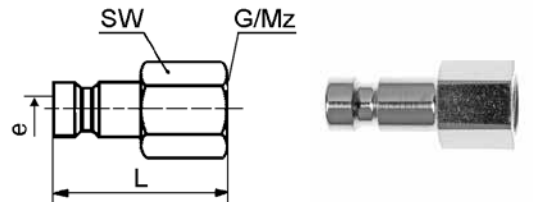

COT 202

Type-G / -Mz	Mat.-Nr.	bar	SW	L	e	kg/100
G=Rohrgewinde (zylindrisch)	G=Filetage-gaz BSP (cylindrique)			G=BSP thread (parallel)		
Mz=metrisches Gewinde (zylindrisch)	Mz=Filetage métrique (cylindrique)			Mz=Metric thread (parallel)		
COT 202-G $\frac{1}{8}$ N	334.2260.020	35	13	19.0	2.7	0.800
COT 202-M5 N	334.2270.080	35	7	17.0	2.7	0.300

Stecker mit Aussengewinde

nicht absperrend

Embout avec filetage

non-obturant

Nipple with male thread

no shut-off

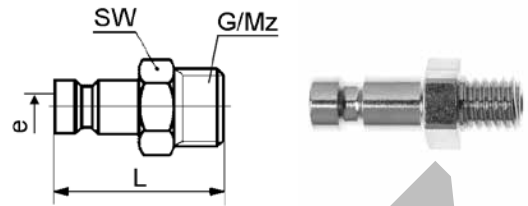

COT 203

Type -G / -Mz	Mat.-Nr.	bar	SW	L	e	kg/100
G=Rohrgewinde (zylindrisch)			G=Filetage-gaz BSP (cylindrique)		G=BSP thread (parallel)	
Mz=metrisches Gewinde (zylindrisch)			Mz=Filetage métrique (cylindrique)		Mz=Metric thread (parallel)	
COT 203-G $\frac{1}{8}$ N	334.2280.020	35	11	20.0	2.7	0.550
COT 203-M5 N	334.2290.080	35	7	20.0	2.7	0.250
COT 203-M8x1 N	334.2290.120	35	9	22.0	2.7	0.550

Teile können mit einer PVC-Dichtscheibe ausgestattet sein.

Les pièces peuvent être équipées d'une rondelle d'étanchéité en PVC.

Parts may be equipped with a PVC sealing washer.

Stecker mit SERTO-Anschluss

nicht absperrend

Embout avec connexion SERTO

non-obturant

Nipple with SERTO connection

no shut-off

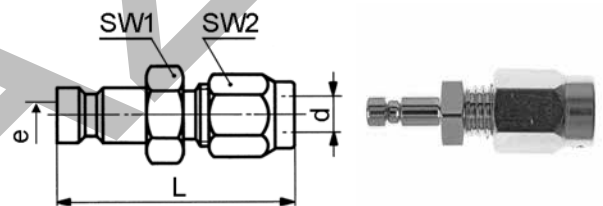

COT 204

Type -d	Mat.-Nr.	bar	SW1	SW2	L	e	kg/100
COT 204-4 N	334.2310.040	35	9	10	29.8	2.7	2.000
COT 204-5 N	334.2310.050	35	9	10	30.4	2.7	2.200

 d=Rohraussen- \emptyset
 LW=Rohrinnen- \emptyset
 e=kleinste Bohrung

 d= \emptyset extérieur du tube
 LW= \emptyset intérieur du tube
 e= \emptyset -min. de passage

 d=tube outside diameter
 LW=tube inside diameter
 e=minimum bore

Kupplungen MS Serie 21

Coupleurs laiton série 21

Couplings brass series 21

Materialien Serie 21

- Kuppler und Stecker: Messing vernickelt
- Feder: Inox 1.4310
- Kugeln: Inox 1.4034
- Dichtungen: NBR

Nennweite

5 = 20 mm²

Betriebstemperatur

-20°C bis +100°C
(abhängig vom Durchflussmedium)

Betriebsdruck

35 bar bei +23°C
maximaler statischer Betriebsdruck (ohne Pulsation) bei min. 4-facher statischer Sicherheit

Kupplungsfunktionen

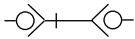

beidseitig absperrend
Kuppler absperrend <CO KA...>
Stecker absperrend <CO TA...>

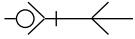

einseitig absperrend
Kuppler absperrend <CO KA...>
Stecker nicht absperrend <CO T...>

Eigenschaften

- überdurchschnittliche Durchflussleistung
- Einhandbedienung

Merkmale

- Funktion: Mini-Industriekupplung
- Einsatz: Pneumatik, Steuerleitungen, Kühlleitungen
- Medien: Flüssigkeiten, Gase

Durchflussleistung

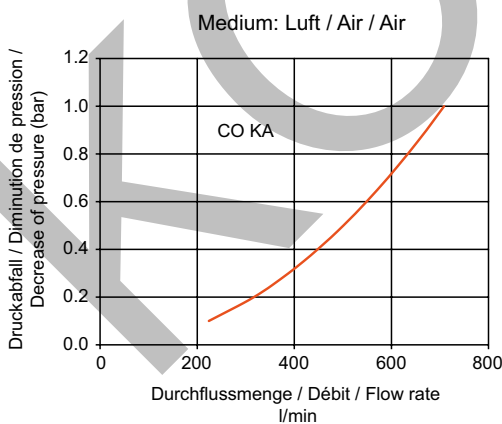

Matériaux séries 21

- Coupleur et embout: laiton nickelé
- Ressort: inox 1.4310
- Billes: inox 1.4034
- Joints: NBR

Largeur nominale

5 = 20 mm²

Plage de température

-20°C à +100°C
(en fonction du fluide d'écoulement)

Pression de service

35 bar à +23°C
pression de service statique max. (sans pulsation) avec un facteur de sécurité statique min. de 4

Fonctions d'accouplement

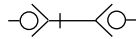

obturant dans les deux sens
coupleur obturant <CO KA...>
embout obturant <CO TA...>

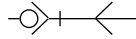

obturant dans un sens
coupleur obturant <CO KA...>
embout non-obturant <CO T...>

Propriétés

- capacité d'écoulement supérieure à la moyenne
- utilisation à une seule main

Caractéristiques

- Fonction: mini-accouplement industriel
- Application: pneumatique, conduites de commande et de refroidissement
- Médium: fluides, gaz

Débit

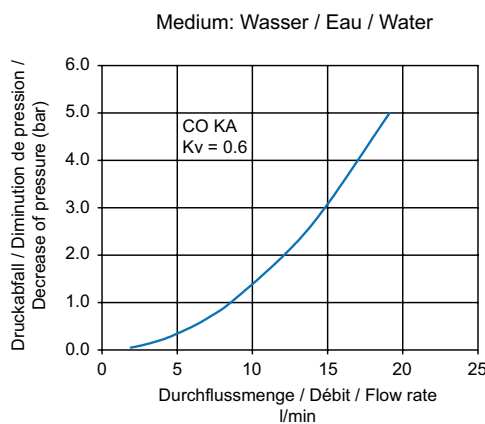

Materials series 21

- Coupler and nipple: brass nickel plated
- Springs, inox 1.4310
- Balls: inox 1.4034
- Seals: NBR

Nominal bore

5 = 20 mm²

Temperature range

-20°C to +100°C
(depending on medium used)

Working pressure

35 bar at +23°C
maximum static operating pressure (without pulsation) at min. static safety of 4

Coupling functions

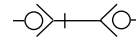

double-sided shut-off
coupler shut-off <CO KA...>
nipple shut-off <CO TA...>

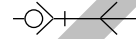

one-sided shut-off
coupler shut-off <CO KA...>
nipple no shut-off <CO T...>

Properties

- above-average flow rate
- one handed operation

Characteristics

- Function: mini industrial coupling
- Uses: pneumatic systems, servo-lines, cooling lines
- Media: fluids, gases

Flow capacity



Kuppler mit Schlauchtülle

absperrend

Coupleur avec douille cannelée pour tuyau

obturant

Coupler with hose nozzle

shut-off

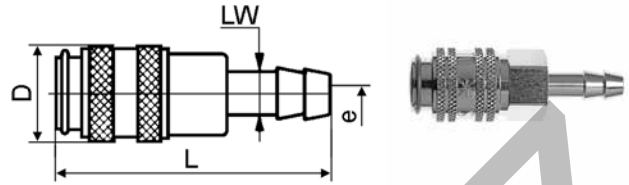

CO KA 211

Type -LW	Mat.-Nr.	bar	L	D	e	kg/100
CO KA 211-LW 4 N	334.2540.040	35	46.0	16.0	2.0	2.500
CO KA 211-LW 6 N	334.2540.060	35	46.0	16.0	4.0	2.600
CO KA 211-LW 8 N	334.2540.080	35	46.0	16.0	6.0	2.700
CO KA 211-LW 9 N	334.2540.090	35	46.0	16.0	6.0	2.800
CO KA 211-LW10 N	334.2540.100	35	46.0	16.0	6.0	2.900

14

Kuppler mit Innengewinde

absperrend

Coupleur avec taraudage

obturant

Coupler with female thread

shut-off

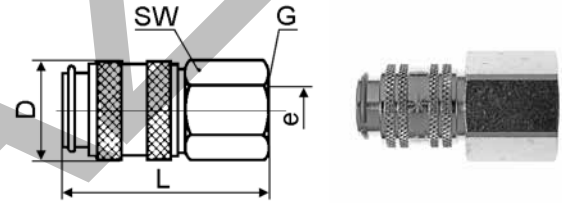

CO KA 212

Type -G	Mat.-Nr.	bar	SW	L	D	e	kg/100
G=Rohrgewinde (zylindrisch)	G=Filetage-gaz BSP (cylindrique)						
					G=BSP thread (parallel)		
CO KA 212-G $\frac{1}{8}$ N	334.2560.020	35	14	36.0	16.0	5.0	2.900
CO KA 212-G $\frac{1}{4}$ N	334.2560.040	35	17	38.0	16.0	5.0	3.400
CO KA 212-G $\frac{3}{8}$ N	334.2560.060	35	19	38.0	16.0	5.0	4.300

d=Rohraussen- \emptyset
LW=Rohrinnen- \emptyset
e=kleinste Bohrung

d= \emptyset extérieur du tube
LW= \emptyset intérieur du tube
e= \emptyset -min. de passage

d=tube outside diameter
LW=tube inside diameter
e=minimum bore

Kuppler mit Aussengewinde

absperrend

Coupleur avec filetage

obturant

Coupler with male thread

shut-off

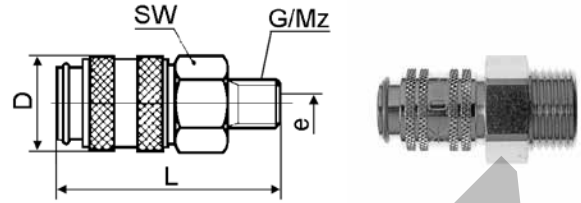

CO KA 213

Type -G / -Mz	Mat.-Nr.	bar	SW	L	D	e	kg/100
G=Rohrgewinde (zylindrisch)							
Mz=metrisches Gewinde (zylindrisch)							
CO KA 213-G $\frac{1}{8}$ N	334.2580.020	35	14	36.0	16.0	5.0	2.700
CO KA 213-G $\frac{1}{4}$ N	334.2580.040	35	17	38.0	16.0	5.0	3.600
CO KA 213-G $\frac{3}{8}$ N	334.2580.060	35	19	38.0	16.0	7.5	4.300
CO KA 213-M10x1 N	334.2590.150	35	14	36.0	16.0	4.5	2.800
CO KA 213-M12x1 N	334.2590.190	35	17	38.0	16.0	5.0	2.900

Teile können mit einer PVC-Dichtscheibe ausgestattet sein.

Les pièces peuvent être équipées d'une rondelle d'étanchéité en PVC.

Parts may be equipped with a PVC sealing washer.

Kuppler mit SERTO-Anschluss

absperrend

Coupleur avec connexion SERTO

obturant

Coupler with SERTO connection

shut-off

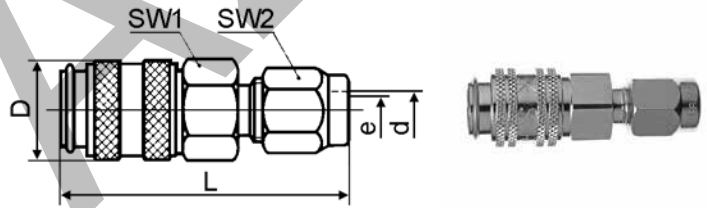

CO KA 214

Type -d	Mat.-Nr.	bar	SW1	SW2	L	D	e	kg/100
CO KA 214-6 N	334.2610.060	35	14	12	46.0	16.0	4.5	3.700
CO KA 214-8 N	334.2610.080	35	14	14	47.0	16.0	5.0	4.000

 d=Rohraussen- \emptyset
 LW=Rohrinnen- \emptyset
 e=kleinste Bohrung

 d= \emptyset extérieur du tube
 LW= \emptyset intérieur du tube
 e= \emptyset -min. de passage

 d=tube outside diameter
 LW=tube inside diameter
 e=minimum bore

Kuppler in Schottausführung mit SERTO-Anschluss

absperrend

Coupleur traversée de cloison avec connexion SERTO

obturant

Panel mount coupler with SERTO connection

shut-off

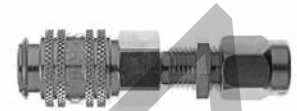
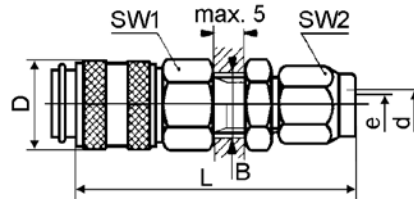

CO KA 215

Type-d	Mat.-Nr.	bar	SW1	SW2	L	D	B	e	kg/100
CO KA 215-6 N	334.2640.060	35	14	12	54.0	16.0	10.5	4.5	4.100
CO KA 215-8 N	334.2640.080	35	14	14	55.0	16.0	12.5	5.0	4.700

Stecker mit Schlauchtülle

nicht absperrend

Embout avec douille cannelée pour tuyau

non-obturant

Nipple with hose nozzle

no shut-off

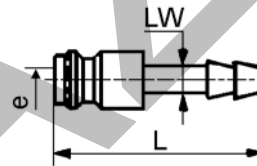

COT 211

Type-LW	Mat.-Nr.	bar	L	e	kg/100
COT 211-LW 4 N	334.2750.040	35	32.0	2.0	0.800
COT 211-LW 6 N	334.2750.060	35	32.0	4.0	0.850
COT 211-LW 8 N	334.2750.080	35	32.0	5.0	0.950
COT 211-LW 9 N	334.2750.090	35	32.0	5.0	0.950
COT 211-LW10 N	334.2750.100	35	32.0	5.0	1.000

Stecker mit Innengewinde

nicht absperrend

Embout avec taraudage

non-obturant

Nipple with female thread

no shut-off

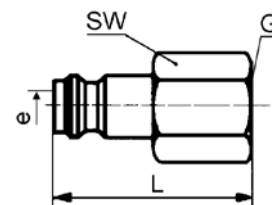

COT 212

Type-G	Mat.-Nr.	bar	SW	L	e	kg/100
G=Rohrgewinde (zylindrisch)	G=Filetage-gaz BSP (cylindrique)	G=BSP thread (parallel)				
COT 212-G $\frac{1}{8}$ N	334.2760.020	35	14	25.0	5.0	1.300
COT 212-G $\frac{1}{4}$ N	334.2760.040	35	17	25.0	5.0	1.900
COT 212-G $\frac{3}{8}$ N	334.2760.060	35	19	27.0	5.0	2.000

Stecker mit Aussengewinde

nicht absperrend

Embout avec filetage

non-obturant

Nipple with male thread

no shut-off

COT 213

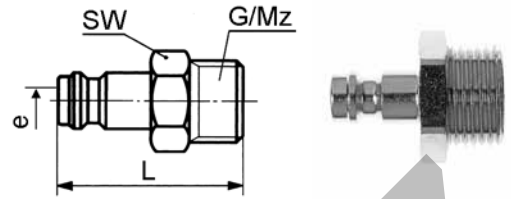

Type -G / -Mz	Mat.-Nr.	bar	SW	L	e	kg/100
G=Rohrgewinde (zylindrisch)			G=Filetage-gaz BSP (cylindrique)		G=BSP thread (parallel)	
Mz=metrisches Gewinde (zylindrisch)			Mz=Filetage métrique (cylindrique)		Mz=Metric thread (parallel)	
COT 213-G $\frac{1}{8}$ N	334.2780.020	35	14	25.0	5.0	1.250
COT 213-G $\frac{1}{4}$ N	334.2780.040	35	17	28.0	5.0	1.800
COT 213-G $\frac{3}{8}$ N	334.2780.060	35	19	28.0	5.0	2.600
COT 213-M10x1 N	334.2790.150	35	14	28.0	4.5	1.300
COT 213-M12x1 N	334.2790.190	35	17	28.0	5.0	1.300

Teile können mit einer PVC-Dichtscheibe ausgestattet sein.

Les pièces peuvent être équipées d'une rondelle d'étanchéité en PVC.

Parts may be equipped with a PVC sealing washer.

Stecker mit SERTO-Anschluss

nicht absperrend

Embout avec connexion SERTO

non-obturant

Nipple with SERTO connection

no shut-off

COT 214

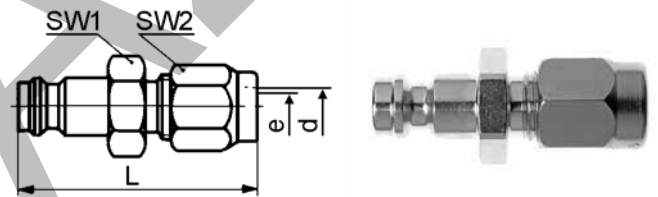

Type -d	Mat.-Nr.	bar	SW1	SW2	L	e	kg/100
COT 214-6 N	334.2810.060	35	14	12	34.0	4.5	2.150
COT 214-8 N	334.2810.080	35	14	14	35.0	5.0	2.500

Stecker mit Schlauchtülle

absperrend

Embout avec douille cannelée pour tuyau

obturant

Nipple with hose nozzle

shut-off

CO TA 211

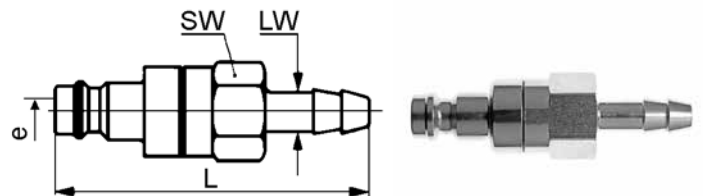

Type -LW	Mat.-Nr.	bar	SW	L	e	kg/100
CO TA 211-LW 4 N	334.2850.040	35	14	50.0	2.0	2.300
CO TA 211-LW 6 N	334.2850.060	35	14	50.0	4.0	2.300

 d=Rohraussen- \emptyset
 LW=Rohrinnen- \emptyset
 e=kleinste Bohrung

 d= \emptyset extérieur du tube
 LW= \emptyset intérieur du tube
 e= \emptyset -min. de passage

 d=tube outside diameter
 LW=tube inside diameter
 e=minimum bore

Stecker mit Innengewinde

absperrend

Embout avec taraudage

obturant

Nipple with female thread

shut-off

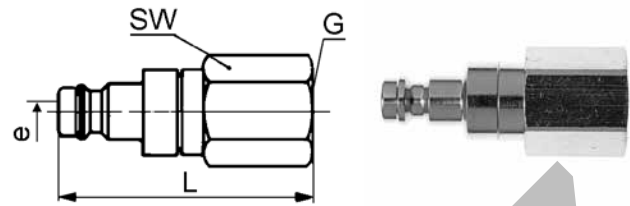

COTA 212

Type -G	Mat.-Nr.	bar	SW	L	e	kg/100
G=Rohrgewinde (zylindrisch)			G=Filetage-gaz BSP (cylindrique)		G=BSP thread (parallel)	
CO TA 212-G $\frac{1}{8}$ N	334.2870.020	35	14	40.0	5.0	3.800
CO TA 212-G $\frac{1}{4}$ N	334.2870.040	35	17	42.0	5.0	4.300

Teile können mit einer PVC-Dichtscheibe ausgestattet sein.

Les pièces peuvent être équipées d'une rondelle d'étanchéité en PVC.

Parts may be equipped with a PVC sealing washer.

Stecker mit Aussengewinde

absperrend

Embout avec filetage

obturant

Nipple with male thread

shut-off

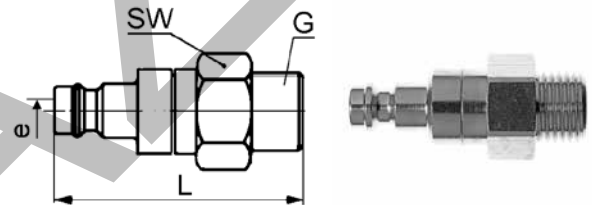

COTA 213

Type -G	Mat.-Nr.	bar	SW	L	e	kg/100
G=Rohrgewinde (zylindrisch)			G=Filetage-gaz BSP (cylindrique)		G=BSP thread (parallel)	
CO TA 213-G $\frac{1}{8}$ N	334.2890.020	35	14	40.0	5.0	1.200
CO TA 213-G $\frac{1}{4}$ N	334.2890.040	35	17	42.0	5.0	1.500

Kupplungen MS Serie 22

Coupleurs laiton série 22

Couplings brass series 22

Materialien Serie 22

- Kuppler: Messing vernickelt
- Stecker, Entriegelungshülse: Stahl gehärtet und vernickelt
- Feder: Inox 1.4310
- Kugeln: Inox 1.4034
- Dichtungen: NBR

Nennweite

5.5 = 25 mm²

Betriebstemperatur

-20°C bis +100°C
(abhängig vom Durchflussmedium)

Betriebsdruck

35 bar bei +23°C
maximaler statischer Betriebsdruck (ohne Pulsation) bei min. 4-facher statischer Sicherheit

Kupplungsfunktionen

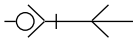

einseitig absperrend
Kuppler absperrend <CO KA...>
Stecker nicht absperrend <CO T...>

Eigenschaften

- hohe Durchflussleistung durch neue Technologie
- Einhandbedienung
- austauschbar mit den gebräuchlichsten Wettbewerbsfabrikaten

Merkmale

- Funktion: Industriekupplung
- Einsatz: für gasförmige Medien in der Industrie, Pneumatik

Durchflussleistung

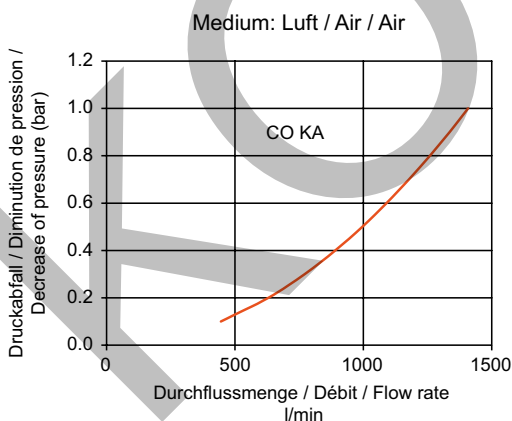

Matériaux séries 22

- Coupleur: laiton nickelé
- Élément connecteur et manchon de déverrouillage: acier trempé et nickelé
- Ressort: inox 1.4310
- Billes: inox 1.4034
- Joints: NBR

Largeur nominale

5.5 = 25 mm²

Plage de température

-20°C à +100°C
(en fonction du fluide d'écoulement)

Pression de service

35 bar à +23°C
pression de service statique max. (sans pulsation) avec un facteur de sécurité statique min. de 4

Fonctions d'accouplement

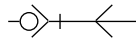

obturant dans un sens
coupleur obturant <CO KA...>
embout non-obturant <CO T...>

Propriétés

- grande capacité d'écoulement grâce à une nouvelle technologie
- utilisation à une seule main
- interchangeable avec les produits concurrents les plus courants

Caractéristiques

- Fonction: accouplement industriel
- Application: pour les fluides gazeux dans l'industrie, pneumatique

Débit

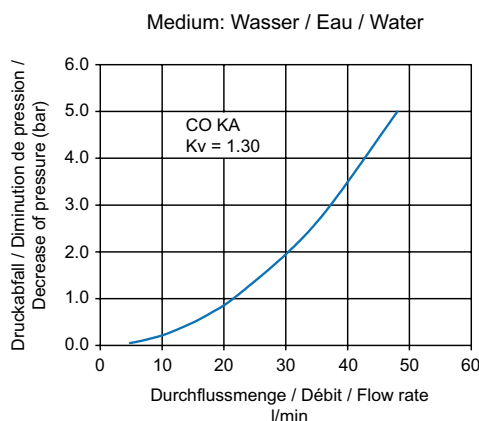

Materials series 22

- Coupler: brass nickel plated
- Nipple and disconnect sleeve: hardened and nickel-plated steel
- Springs: inox 1.4310
- Balls: inox 1.4034
- Seals: NBR

Nominal bore

5.5 = 25 mm²

Temperature range

-20°C to +100°C
(depending on medium used)

Working pressure

35 bar at +23°C
maximum static operating pressure (without pulsation) at min. static safety of 4

Coupling functions

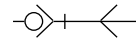

one-sided shut-off
coupler shut-off <CO KA...>
nipple no shut-off <CO T...>

Properties

- high flow rate due to new technology
- one-handed operation
- compatible with conventional competitive brands

Characteristics

- Function: industrial coupling
- Uses: for gaseous media in industry, pneumatic systems

Flow capacity



Kuppler mit Schlauchtülle

absperrend

Coupleur avec douille cannelée pour tuyau

obturant

Coupler with hose nozzle

shut-off

CO KA 221

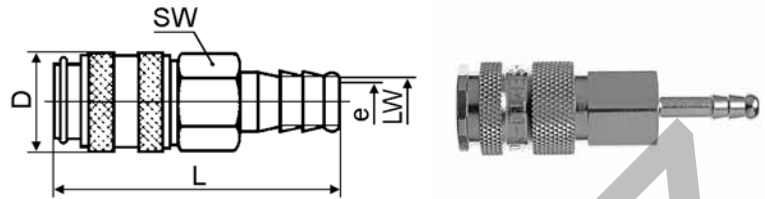

Type -LW	Mat.-Nr.	bar	SW	L	D	e	kg/100
CO KA 221-LW 6 N	334.3040.060	35	19	74.0	23.0	5.0	8.200
CO KA 221-LW 8 N	334.3040.080	35	19	74.0	23.0	5.5	8.400
CO KA 221-LW10 N	334.3040.100	35	19	74.0	23.0	5.5	8.500

14

Kuppler mit Innengewinde

absperrend

Coupleur avec taraudage

obturant

Coupler with female thread

shut-off

CO KA 222

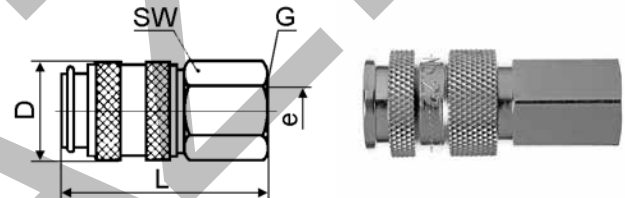

Type -G	Mat.-Nr.	bar	SW	L	D	e	kg/100
G=Rohrgewinde (zylindrisch)	G=Filetage-gaz BSP (cylindrique)	G=BSP thread (parallel)					
CO KA 222-G $\frac{1}{4}$ N	334.3060.040	35	19	56.0	23.0	5.5	9.400
CO KA 222-G $\frac{3}{8}$ N	334.3060.060	35	19	55.0	23.0	5.5	8.600
CO KA 222-G $\frac{1}{2}$ N	334.3060.080	35	24	58.0	23.0	5.5	11.800

Kuppler mit Aussengewinde

absperrend

Coupleur avec filetage

obturant

Coupler with male thread

shut-off

CO KA 223

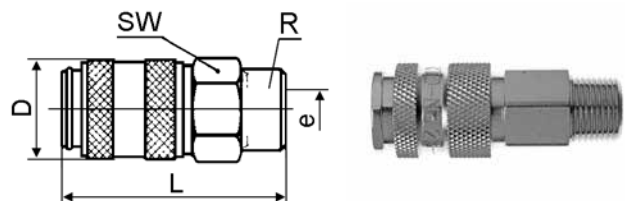

Type -R	Mat.-Nr.	bar	SW	L	D	e	kg/100
R=Rohrgewinde (kegelig)	R=Filetage-gaz BSP (conique)	R=BSP thread (tapered)					
CO KA 223-R $\frac{1}{4}$ N	334.3080.040	35	19	61.0	23.0	5.5	9.000
CO KA 223-R $\frac{3}{8}$ N	334.3080.060	35	19	61.0	23.0	5.5	9.200
CO KA 223-R $\frac{1}{2}$ N	334.3080.080	35	22	66.0	23.0	5.5	11.700

Stecker mit Schlauchtülle

nicht absperrend

Embout avec douille cannelée pour tuyau

non-obturant

Nipple with hose nozzle

no shut-off

COT 221

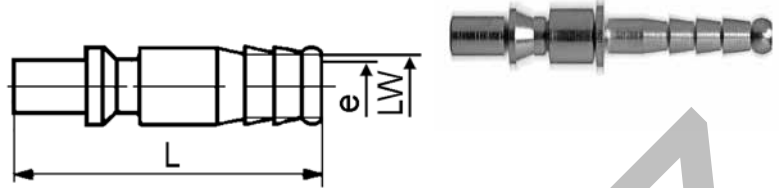

Type -LW	Mat.-Nr.	bar	L	e	kg/100
COT 221-LW 6 S	336.3250.060	35	48.5	5.0	1.300
COT 221-LW 8 S	336.3250.080	35	48.5	5.5	1.500
COT 221-LW10 S	336.3250.100	35	48.5	5.5	1.600

Stecker mit Innengewinde

nicht absperrend

Embout avec taraudage

non-obturant

Nipple with female thread

no shut-off

COT 222

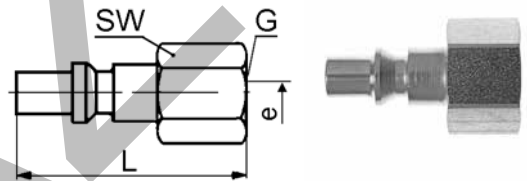

Type -G	Mat.-Nr.	bar	SW	L	e	kg/100
G=Rohrgewinde (zylindrisch)	G=Filetage-gaz BSP (cylindrique)				G=BSP thread (parallel)	
COT 222-G $\frac{1}{4}$ S	336.3260.040	35	17	35.0	5.5	2.400
COT 222-G $\frac{3}{8}$ S	336.3260.060	35	19	35.0	5.5	2.500
COT 222-G $\frac{1}{2}$ S	336.3260.080	35	24	39.0	5.5	3.800

Stecker mit Aussengewinde

nicht absperrend

Embout avec filetage

non-obturant

Nipple with male thread

no shut-off

COT 223

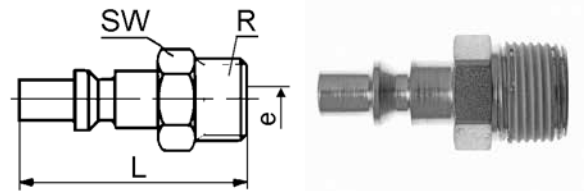

Type -R	Mat.-Nr.	bar	SW	L	e	kg/100
R=Rohrgewinde (kegelig)	R=Filetage-gaz BSP (conique)				R=BSP thread (tapered)	
COT 223-R $\frac{1}{4}$ S	336.3280.040	35	14	41.0	5.5	2.300
COT 223-R $\frac{3}{8}$ S	336.3280.060	35	17	41.0	5.5	2.600
COT 223-R $\frac{1}{2}$ S	336.3280.080	35	22	47.0	5.5	4.300

Schnellkupplung mechanisch und farblich codiert
Accouplement rapide avec codage mécanique et couleur
Quick coupling with mechanical and color coding

SERTO Safety
Serie 50

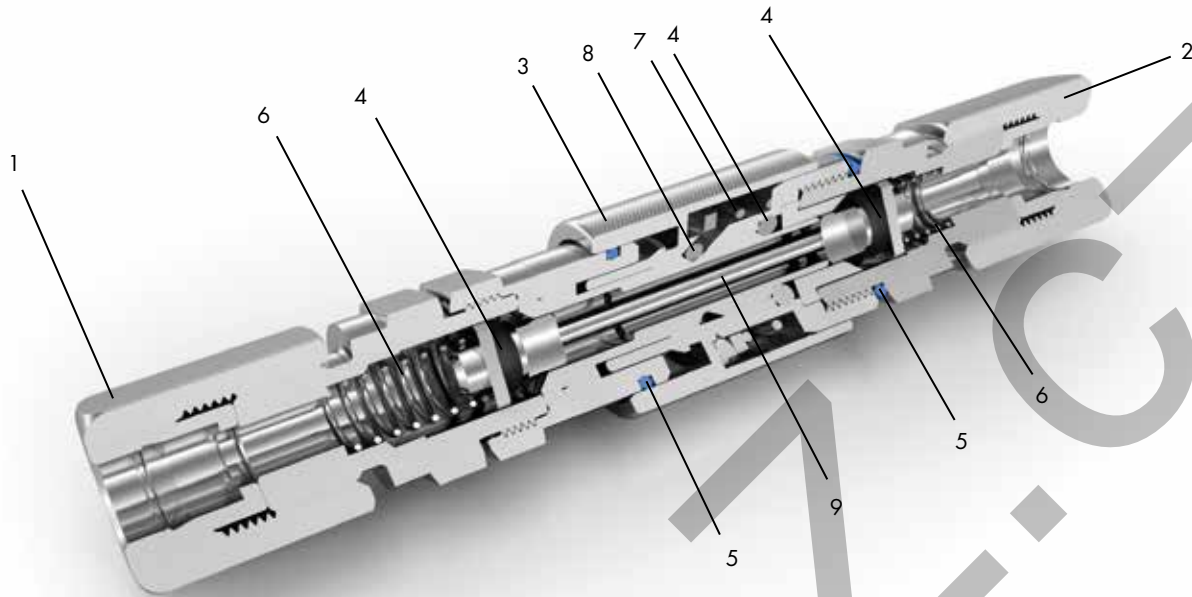

14

Nr. No. No.	Bezeichnung Désignation Description	Material Matériau Material	Nr. No. No.	Bezeichnung Désignation Description	Material Matériau Material	Nr. No. No.	Bezeichnung Désignation Description	Material Matériau Material
1	Stecker Embout Nipple	Inox 1.4571	4*	Dichtung Joint Seal	FKM (FDA)	7	Rückstellfeder Ressort de rappel Return spring	Inox 1.4310
2	Kuppler Coupleur Coupler	Inox 1.4571	5*	Farbcodierung Codage couleur Color coding	FKM	8	Walze Rouleau Roller	Inox 1.4305
3	Schiebehülse Bague coulissante Sliding sleeve	Inox 1.4571	6	Druckfeder Ressort de compression Compression spring	Inox 1.4310	9	Ventil (Variante) Soupape (option) Valve (option)	Inox 1.4571

Spezifikationen

Betriebsdruck (PN): 200 bar
 Temperatur: -20°C bis +120°C
 Sterilisierbar: ja
 Sicherheitsfaktor: 1.5-fach

Merkmale

Die farbcodierte Ausführung, wahlweise in blau, grün, gelb oder rot, bietet wesentliche Vorteile in Bezug auf die **Sicherheit** im Einsatz. Korrektes Kuppeln wird optisch durch die Farbringe und mechanisch durch die Geometrie der Teile gewährleistet. Dank dem innovativen Design lassen sich die Farben untereinander nicht kuppeln.

*** Optionen erhältlich**

- 4 - Dichtung: andere Materialien auf Anfrage
- 5 - Codierung: Farben blau, rot, grün, gelb
- Reinigen / Schmieren: OX (für Verwendung mit Sauerstoff) und SI (silikonfrei)

Spécifications

Pression de service (PN): 200 bar
 Température: -20°C à +120°C
 Stérilisable: oui
 Facteur de sécurité: 1.5 fois

Caractéristiques

Le modèle avec codage couleur, disponible en bleu, vert, jaune ou rouge, offre d'importants avantages en termes de **sécurité**. Les couleurs et les profils garantissent de toujours effectuer un raccordement correct et évitent toute confusion. Grâce à la conception innovante, il n'est pas possible de raccorder différentes couleurs ensemble.

*** Options disponible**

- 4 - Joint: autres joints sur demande
- 5 - Codage: couleurs bleu, rouge, vert, jaune
- Nettoyage / lubrification: OX (pour usage avec de l'oxygène) et SI (sans silicone)

Specifications

Working pressure (PN): 200 bar
 Temperature: -20°C to +120°C
 Sterilizable: yes
 Safety factor: 1.5 times

Characteristics

The color coded version provides significant advantages in respect of **safety in use** and is available in blue, green, yellow and red. Correct coupling is guaranteed visually with the different colored options and mechanically with the geometry of the parts - differing colors will not interconnect.

*** Options available**

- 4 - Seal: other materials on request
- 5 - Coding: colors blue, red, green, yellow
- Cleaning / lubricating: OX (for use with oxygen) and SI (silicone-free)

Druckauswertungsgrad in % des PN

Coefficient de pression en % de PN

Pressure coefficient in % of PN

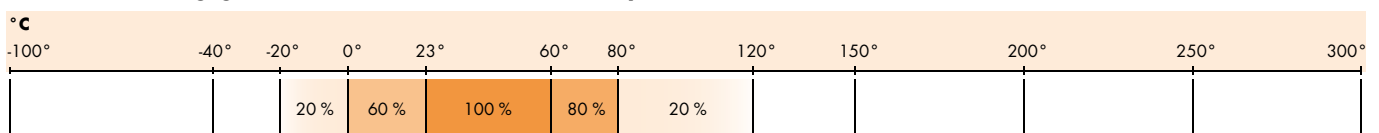

Druckverlustkurve Wasser

Courbe de perte de charge eau

Pressure loss curve for water

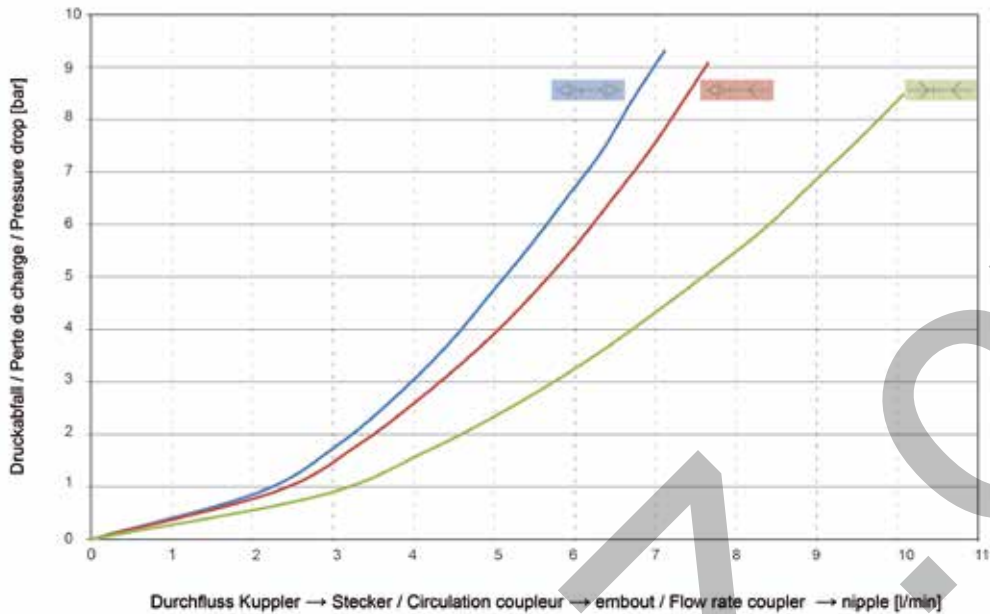

Kupplungsfunktionen

beidseitig absperrend
Kuppler absperrend Q50 C..V
Stecker absperrend Q50 N..V

einseitig absperrend
Kuppler absperrend Q50 C..V
Stecker nicht absperrend Q50 N..P

nicht absperrend
Kuppler nicht absperrend Q50 C..P
Stecker nicht absperrend Q50 N..P

Fonctions d'accouplement

obturant dans les deux sens
coupleur obturant Q50 C..V
embout obturant Q50 N..V

obturant dans un sens
coupleur obturant Q50 C..V
embout non-obturant Q50 N..P

non-obturant
coupleur non-obturant Q50 C..P
embout non-obturant Q50 N..P

Coupling functions

double-sided shut-off
coupler shut-off Q50 C..V
nipple shut-off Q50 N..V

one-sided shut-off
coupler shut-off Q50 C..V
nipple no shut-off Q50 N..P

no shut-off
coupler no shut-off Q50 C..P
nipple no shut-off Q50 N..P

Bestellhinweis Materialbezeichnung

Bsp.: Q50 C04VS-6 B

Codification pour commande

Exemple: Q50 C04VS-6 B

Order information material description

Example: Q50 C04VS-6 B

Q	Kupplung SERTO	Accouplement SERTO	Coupling SERTO
5	Material (Edelstahl)	Matériau (acier inoxydable)	Material (stainless steel)
0	Serie	Série	Series
C	C Kuppler (Coupler) N Stecker (Nipple)	C coupleur (Coupler) N embout (Nipple)	C Coupler N Nipple
04	DN 04	DN 04	DN 04
V	V absperrend (Valve) P nicht absperrend (Plain)	V obturant (Valve) P non-obturant (Plain)	V shut-off (Valve) P no shut-off (Plain)
S	S SERTO-Anschluss P Schottausführung m. SERTO-Anschluss M Aussengewinde (zylindrisch)	S connexion SERTO P traversée de cloison avec connex. SERTO M filetage (cylindrique)	S SERTO connection P panel mount with SERTO connection M male thread (parallel)
-6	Grösse - Rohraussen-Durchmesser - oder Gewinde	Dimension - diamètre extérieur du tube - ou filetage	Size - tube outside diameter - or thread
B	Farbe - B blau - R rot - G grün - Y gelb	Couleur - B bleu - R rouge - G vert - Y jaune	Color - B blue - R red - G green - Y yellow

Kuppler codiert mit SERTO-Anschluss

nicht absperrend

Coupleur codé avec connexion SERTO

non-obturant

Coupler coded with SERTO connection

no shut-off

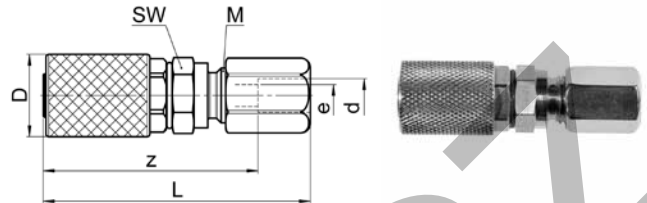

Q50 C..PS

Type-d	Mat.-Nr.	bar	Col	M	SW	L	D	z	e	kg/100
Q50 C04PS-6 B	298.1100.060	200	blue	10x1.0	12	45.0	15.0	37.0	4.0	3.400
Q50 C04PS-6 R	298.1110.060	200	red	10x1.0	12	45.0	15.0	37.0	4.0	3.400
Q50 C04PS-6 G	298.1120.060	200	green	10x1.0	12	45.0	15.0	37.0	4.0	3.400
Q50 C04PS-6 Y	298.1130.060	200	yellow	10x1.0	12	45.0	15.0	37.0	4.0	3.400

Kuppler codiert mit SERTO-Anschluss

absperrend

Coupleur codé avec connexion SERTO

obturant

Coupler coded with SERTO connection

shut-off

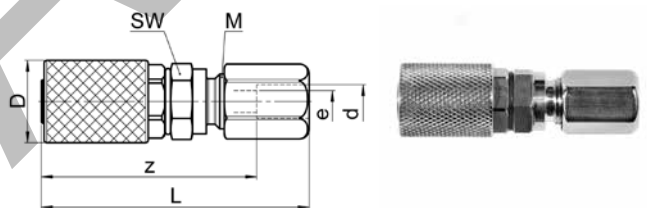

Q50 C..VS

Type-d	Mat.-Nr.	bar	Col	M	SW	L	D	z	e	kg/100
Q50 C04VS-6 B	298.2100.060	200	blue	10x1.0	12	47.0	15.0	39.0	4.0	3.700
Q50 C04VS-6 R	298.2110.060	200	red	10x1.0	12	47.0	15.0	39.0	4.0	3.700
Q50 C04VS-6 G	298.2120.060	200	green	10x1.0	12	47.0	15.0	39.0	4.0	3.700
Q50 C04VS-6 Y	298.2130.060	200	yellow	10x1.0	12	47.0	15.0	39.0	4.0	3.700

Kuppler codiert in Schottausführung mit SERTO-Anschluss

nicht absperrend

Coupleur traversée de cloison codé avec connexion SERTO

non-obturant

Panel mount coupler coded with SERTO connection

no shut-off

Q50 C..PP

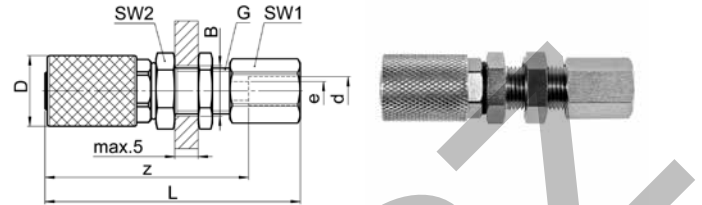

Type-d	Mat.-Nr.	bar	Col	G	SW1	SW2	L	D	B	z	e	kg/100
Q50 C04PP-6 B	298.1200.060	200	blue	1/8	12	14	54.0	15.0	10.0	46.0	4.0	3.500
Q50 C04PP-6 R	298.1210.060	200	red	1/8	12	14	54.0	15.0	10.0	46.0	4.0	3.500
Q50 C04PP-6 G	298.1220.060	200	green	1/8	12	14	54.0	15.0	10.0	46.0	4.0	3.500
Q50 C04PP-6 Y	298.1230.060	200	yellow	1/8	12	14	54.0	15.0	10.0	46.0	4.0	3.500

Kuppler codiert in Schottausführung mit SERTO-Anschluss

absperrend

Coupleur traversée de cloison codé avec connexion SERTO

obturant

Panel mount coupler coded with SERTO connection

shut-off

Q50 C..VP

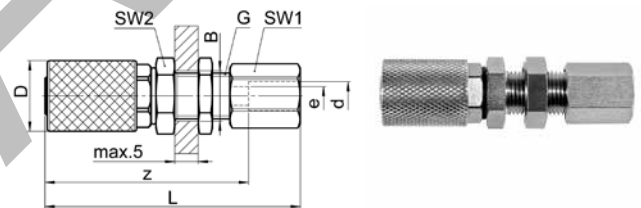

Type-d	Mat.-Nr.	bar	Col	G	SW1	SW2	L	D	B	z	e	kg/100
Q50 C04VP-6 B	298.2200.060	200	blue	1/8	12	14	54.0	15.0	10.0	46.0	4.0	3.800
Q50 C04VP-6 R	298.2210.060	200	red	1/8	12	14	54.0	15.0	10.0	46.0	4.0	3.800
Q50 C04VP-6 G	298.2220.060	200	green	1/8	12	14	54.0	15.0	10.0	46.0	4.0	3.800
Q50 C04VP-6 Y	298.2230.060	200	yellow	1/8	12	14	54.0	15.0	10.0	46.0	4.0	3.800

Kuppler codiert in Schottausführung mit Aussengewinde

absperrend

Coupleur traversée de cloison codé avec filetage

obturant

Panel mount coupler coded with male thread

shut-off

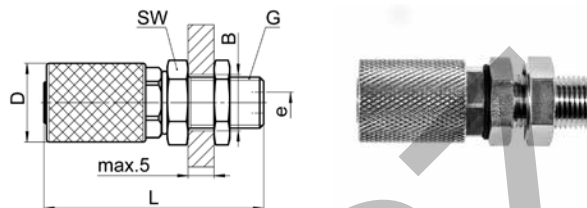

Q50 C..VM

Type -G	Mat.-Nr.	bar	Col	SW	L	D	B	e	kg/100
G=Rohrgewinde (zylindrisch)	G=Filetage-gaz BSP (cylindrique)								

Stecker codiert mit SERTO-Anschluss

nicht absperrend

Embout codé avec connexion SERTO

non-obturant

Nipple coded with SERTO connection

no shut-off

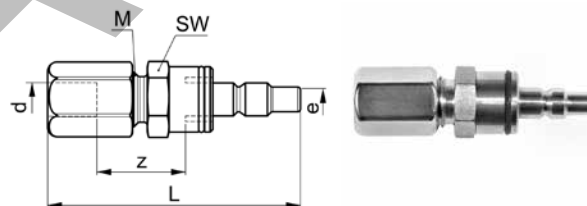

Q50 N..PS

Type -d	Mat.-Nr.	bar	Col	M	SW	L	z	e	kg/100
Q50 N04PS-6 B	298.4100.060	200	blue	10x1.0	12	44.5	16.0	3.5	2.400
Q50 N04PS-6 R	298.4110.060	200	red	10x1.0	12	44.5	16.0	3.5	2.400
Q50 N04PS-6 G	298.4120.060	200	green	10x1.0	12	44.5	16.0	3.5	2.400
Q50 N04PS-6 Y	298.4130.060	200	yellow	10x1.0	12	44.5	16.0	3.5	2.400

Stecker codiert mit SERTO-Anschluss

absperrend

Embout codé avec connexion SERTO

obturant

Nipple coded with SERTO connection

shut-off

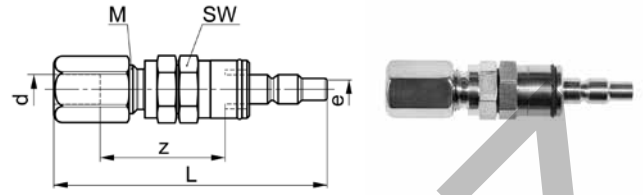

Q50 N..VS

Type-d	Mat.-Nr.	bar	Col	M	SW	L	z	e	kg/100
Q50 N04VS-6 B	298.5100.060	200	blue	10x1.0	12	54.5	26.5	3.5	3.000
Q50 N04VS-6 R	298.5110.060	200	red	10x1.0	12	54.5	26.5	3.5	3.000
Q50 N04VS-6 G	298.5120.060	200	green	10x1.0	12	54.5	26.5	3.5	3.000
Q50 N04VS-6 Y	298.5130.060	200	yellow	10x1.0	12	54.5	26.5	3.5	3.000

Stecker codiert mit Aussengewinde

nicht absperrend

Embout codé avec filetage

non-obturant

Nipple coded with male thread

no shut-off

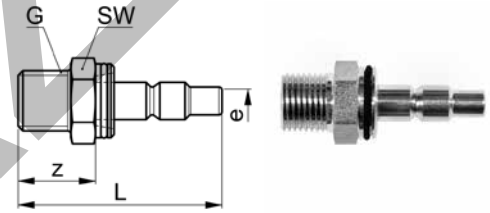

Q50 N..PM

Type-G	Mat.-Nr.	bar	Col	SW	L	z	e	kg/100
G=Rohrgewinde (zylindrisch)	G=Filetage-gaz BSP (cylindrique)							
Q50 N04PM-1/8 B	298.4400.060	200	blue	12	33.0	12.5	3.5	1.100

Schnellkupplung – kompakt und hoher Durchfluss
Accouplement rapide – compact et haut débit
Quick coupling – compact and high flow rate

**SERTO Flow
Serie 51**

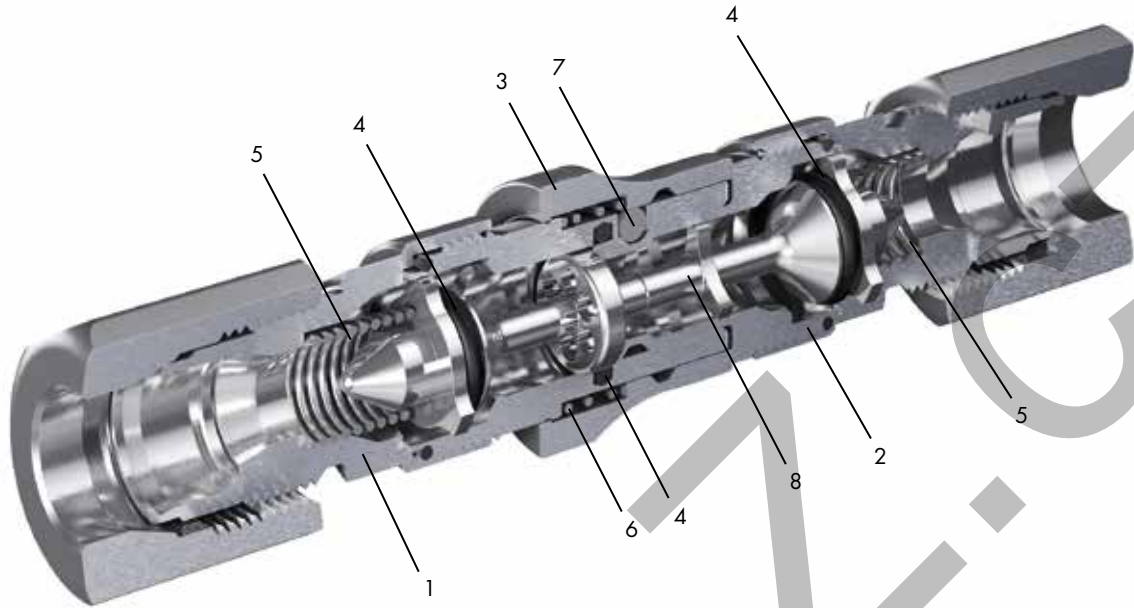

14

Nr. No. No.	Bezeichnung Désignation Description	Material Matériau Material	Nr. No. No.	Bezeichnung Désignation Description	Material Matériau Material	Nr. No. No.	Bezeichnung Désignation Description	Material Matériau Material
1	Stecker Embout Nipple	Inox 1.4571	4*	Dichtung Joint Seal	FKM (FDA)	7	Kugeln Billes Balls	Inox 1.4404
2	Kuppler Coupleur Coupler	Inox 1.4571	5	Druckfeder Ressort de compression Compression spring	Inox 1.4571/1.4404	8	Ventil (Variante) Soupape (option) Valve (option)	Inox 1.4571
3	Schiebehülse Bague coulissante Sliding sleeve	Inox 1.4571	6	Rückstellfeder Ressort de rappel Return spring	Inox 1.4571/1.4404			

Spezifikationen

Betriebsdruck (PN): 65 bis 200 bar
 Temperatur: -15°C bis +200°C
 Sterilisierbar: ja
 Sicherheitsfaktor: 1.5-fach

Merkmale

- überdurchschnittlich hoher Durchfluss bei geringem Druckabfall
- ergonomisches Design
- Einhandbedienung für effizientes Kuppeln und entkuppeln
- glatte Oberfläche, einfaches Reinigen, geringe Schmutzanansammlung

*** Optionen erhältlich**

- 4 - Dichtung: andere Materialien auf Anfrage (EPDM, FFKM, VMQ, NBR)
- Reinigen / Schmieren: OX (für Verwendung mit Sauerstoff) und SI (silikonfrei)

Spécifications

Pression de service (PN): 65 à 200 bar
 Température: -15°C à +200°C
 Stérilisable: oui
 Facteur de sécurité: 1.5 fois

Caractéristiques

- débit supérieur à la moyenne avec une faible perte de pression
- conception ergonomique
- utilisation d'une seule main pour couplage et découplage efficace et pratique
- surface lisse, nettoyage simplifié, faible accumulation de saletés

*** Options disponible**

- 4 - Joint: autres matériaux sur demande (EPDM, FFKM, VMQ, NBR)
- Nettoyage / lubrification: OX (pour usage avec de l'oxygène) et SI (sans silicone)

Specifications

Working pressure (PN): 65 to 200 bar
 Temperature: -15°C to +200°C
 Sterilizable: yes
 Safety factor: 1.5 times

Characteristics

- higher-than-average flow rate with low pressure drop
- ergonomic design
- one-hand operation for efficient and convenient coupling and decoupling
- smooth surface, easy cleaning, low dirt accumulation

*** Options available**

- 4 - Seal: other materials on request (EPDM, FFKM, VMQ, NBR)
- Cleaning / lubricating: OX (for use with oxygen) and SI (silicone-free)

Druckauswertungsgrad in % des PN

Coefficient de pression en % de PN

Pressure coefficient in % of PN

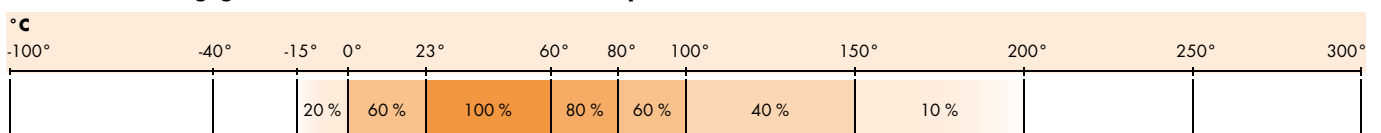

Druckverlustkurve Wasser

Courbe de perte de charge eau

Pressure loss curve for water

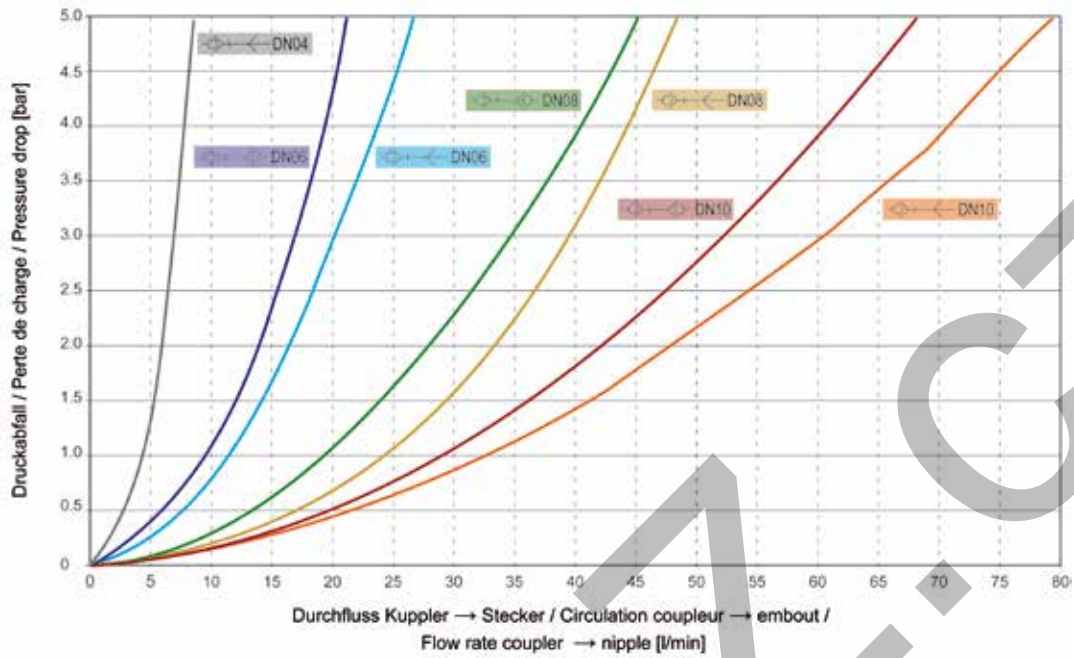

Kupplungsfunktionen

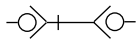

beidseitig absperrend
Kuppler absperrend Q51 C..V
Stecker absperrend Q51 N..V

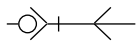

einseitig absperrend
Kuppler absperrend Q51 C..V
Stecker nicht absperrend Q51 N..P

Fonctions d'accouplement

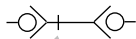

obturant dans les deux sens
coupleur obturant Q51 C..V
embout obturant Q51 N..V



obturant dans un sens
coupleur obturant Q51 C..V
embout non-obturant Q51 N..P

Coupling functions

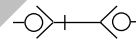

double-sided shut-off
coupler shut-off Q51 C..V
nipple shut-off Q51 N..V

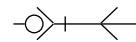

one-sided shut-off
coupler shut-off Q51 C..V
nipple no shut-off Q51 N..P

Bestellhinweis Materialbezeichnung

Bsp.: Q51 C04VS-6

Codification pour commande

Exemple: Q51 C04VS-6

Order information material description

Example: Q51 C04VS-6

Q	Kupplung SERTO	Accouplement SERTO	Coupling SERTO
5	Material (Edelstahl)	Matériau (acier inoxydable)	Material (stainless steel)
1	Serie	Série	Series
C	C Kuppler (C oupler) N Stecker (N ipple)	C coupleur (C oupler) N embout (N ipple)	C C oupler N N ipple
04	DN 04 06 08 10	DN 04 06 08 10	DN 04 06 08 10
V	V absperrend (V alve) P nicht absperrend (P lain)	V obturant (V alve) P non-obturant (P lain)	V shut-off (V alve) P no shut-off (P lain)
S	S SERTO-Anschluss P Schottausführung m. SERTO-Anschluss M Aussengewinde (zylindrisch) F Innengewinde (zylindrisch) N Schlauchtülle	S connexion SERTO P traversée de cloison avec connex. SERTO M filetage (cylindrique) F taraudage (cylindrique) N douille cannelée	S SERTO connection P panel mount with SERTO connection M male thread (parallel) F female thread (parallel) N hose nozzle
-6	Grösse - Rohraussen-Durchmesser - oder Gewinde	Dimension - diamètre extérieur du tube - ou filetage	Size - tube outside diameter - or thread

Kuppler mit SERTO-Anschluss

absperrend

Coupleur avec connexion SERTO

obturant

Coupler with SERTO connection

shut-off

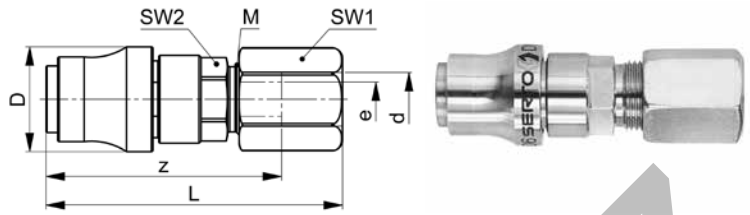

Q51 C..VS

Type -DN -d	Mat.-Nr.	bar	DN	M	SW1	SW2	L	D	z	e	kg/100
* Q51 C04VS-4	C58.2151.040	200	04	10x1.0	12	11	37.5	14.0	29.5	3.0	2.060
* Q51 C04VS-5	C58.2151.050	200	04	10x1.0	12	11	37.5	14.0	29.5	3.0	2.050
Q51 C04VS-6	C58.2151.060	200	04	10x1.0	12	11	37.5	14.0	29.5	3.0	2.360
* Q51 C06VS-8	C58.2152.080	100	06	14x1.0	17	14	56.0	20.0	44.5	6.0	5.770
Q51 C06VS-10	C58.2152.100	100	06	14x1.0	17	14	56.0	20.0	44.5	6.0	6.700
Q51 C08VS-12	C58.2153.120	65	08	16x1.0	19	19	65.5	25.0	51.0	8.0	11.900
Q51 C10VS-15	C58.2154.150	65	10	20x1.5	24	24	78.0	30.0	63.5	10.0	22.500

Nur Typen mit dem gleichen DN (Nennweite) lassen sich miteinander koppeln.

Seuls les types ayant le même DN (diamètre nominal) peuvent être couplés entre eux.

Only types with the same DN (nominal diameter) can be coupled together.

Kuppler in Schottausführung mit SERTO-Anschluss

absperrend

Coupleur traversée de cloison avec connexion SERTO

obturant

Panel mount coupler with SERTO connection

shut-off

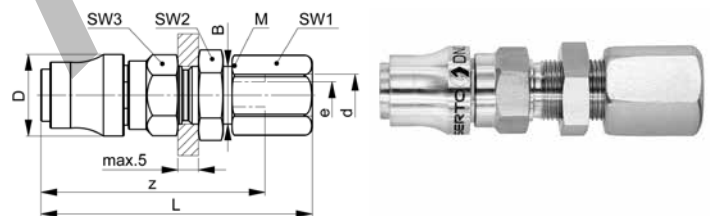

Q51 C..VP

Type -DN -d	Mat.-Nr.	bar	DN	M	SW1	SW2	SW3	L	D	B	z	e	kg/100
* Q51 C04VP-4	C58.2251.040	200	04	10x1.0	12	14	13	47.5	14.0	10.5	39.5	3.0	3.030
* Q51 C04VP-5	C58.2251.050	200	04	10x1.0	12	14	13	47.5	14.0	10.5	39.5	3.0	3.020
Q51 C04VP-6	C58.2251.060	200	04	10x1.0	12	14	13	47.5	14.0	10.5	39.5	3.0	3.330
* Q51 C06VP-8	C58.2252.080	100	06	14x1.0	17	19	17	66.0	20.0	14.5	54.5	6.0	7.690
Q51 C06VP-10	C58.2252.100	100	06	14x1.0	17	19	17	66.0	20.0	14.5	54.5	6.0	8.620
Q51 C08VP-12	C58.2253.120	65	08	16x1.0	19	22	22	75.5	25.0	16.5	61.7	8.0	14.600
Q51 C10VP-15	C58.2254.150	65	10	20x1.5	24	27	27	88.0	30.0	20.5	73.5	10.0	26.200

Nur Typen mit dem gleichen DN (Nennweite) lassen sich miteinander koppeln.

Seuls les types ayant le même DN (diamètre nominal) peuvent être couplés entre eux.

Only types with the same DN (nominal diameter) can be coupled together.

d=Rohrassen-ø
LW=Rohrinnen-ø
e=kleinste Bohrung
*=mit reduziertem Klemmring

d=ø extérieur du tube
LW=ø intérieur du tube
e=ø-min. de passage
*=avec bague de serrage de réduction

d=tube outside diameter
LW=tube inside diameter
e=minimum bore
*=with reduction compression ferrule

Kuppler mit Aussengewinde

mit Conovor O-Ringabdichtung (FKM), absperrend

Coupleur avec filetage

avec joint torique système Conovor (FKM), obturant

Coupler with male thread

with Conovor O-ring seal (FKM), shut-off

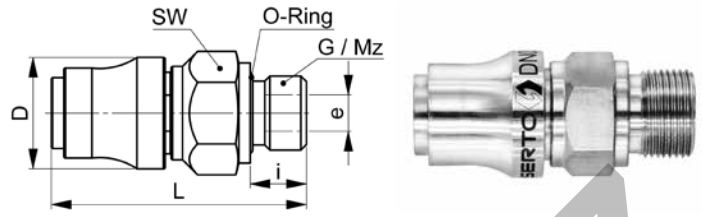

Q51 C..VM

Type -DN -G / -Mz	Mat.-Nr.	bar	DN	SW	L	D	i	O-Ring	e	kg/100
G=Rohrgewinde (zylindrisch)				G=Filetage-gaz BSP (cylindrique)			G=BSP thread (parallel)			
Mz=metrisches Gewinde (zylindrisch)				Mz=Filetage métrique (cylindrique)			Mz=Metric thread (parallel)			
Q51 C04VM-1/8 OR	C58.2451.100	200	04	12	21.5	14.0	8.0	8.73x1.78	3.0	1.740
Q51 C04VM-M5	C58.2451.155	200	04	11	33.0	14.0	3.5	-	2.5	1.200
Q51 C06VM-1/4 OR	C58.2452.270	100	06	19	45.5	20.0	10.0	11.1x1.78	6.0	5.520
Q51 C08VM-3/8 OR	C58.2453.390	65	08	22	52.0	25.0	10.0	14.0x1.78	8.0	9.900
Q51 C10VM-1/2 OR	C58.2454.534	65	10	27	63.0	30.0	12.0	18.72x2.62	10.0	17.900

Grösse M5 mit POM-Dichtscheibe.

Taille M5 avec joint en POM.

Size M5 with POM sealing washer.

Nur Typen mit dem gleichen DN (Nennweite) lassen sich miteinander koppeln.

Seuls les types ayant le même DN (diamètre nominal) peuvent être couplés entre eux.

Only types with the same DN (nominal diameter) can be coupled together.

Kuppler mit Innengewinde

absperrend

Coupleur avec taraudage

obturant

Coupler with female thread

shut-off

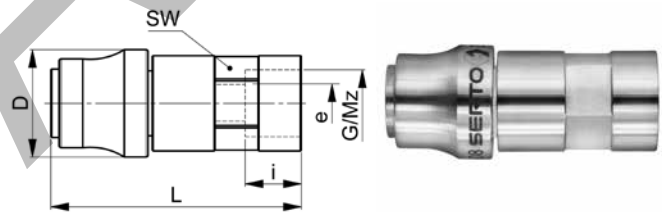

Q51 C..VF

Type -DN -G / -Mz	Mat.-Nr.	bar	DN	SW	L	D	i	e	kg/100	
G=Rohrgewinde (zylindrisch)				G=Filetage-gaz BSP (cylindrique)			G=BSP thread (parallel)			
Mz=metrisches Gewinde (zylindrisch)				Mz=Filetage métrique (cylindrique)			Mz=Metric thread (parallel)			
Q51 C04VF-1/8	C58.2751.100	200	04	12	38.5	14.0	10.0	3.0	2.400	
Q51 C04VF-M5	C58.2751.155	200	04	9	34.0	14.0	5.0	3.0	1.800	
Q51 C06VF-1/4	C58.2752.270	100	06	14	52.0	20.0	13.0	6.0	5.600	
Q51 C08VF-3/8	C58.2753.390	65	08	19	58.0	25.0	13.0	8.0	11.200	
Q51 C10VF-1/2	C58.2754.534	65	10	24	71.0	30.0	16.0	10.0	20.300	

Nur Typen mit dem gleichen DN (Nennweite) lassen sich miteinander koppeln.

Seuls les types ayant le même DN (diamètre nominal) peuvent être couplés entre eux.

Only types with the same DN (nominal diameter) can be coupled together.

d=Rohrassen-ø
LW=Rohrinnen-ø
e=kleinste Bohrung
*=mit reduziertem Klemmring

d=ø extérieur du tube
LW=ø intérieur du tube
e=ø-min. de passage
*=avec bague de serrage de réduction

d=tube outside diameter
LW=tube inside diameter
e=minimum bore
*=with reduction compression ferrule

Stecker mit SERTO-Anschluss

nicht absperrend

Embout avec connexion SERTO

non-obturant

Nipple with SERTO connection

no shut-off

Q51 N..PS

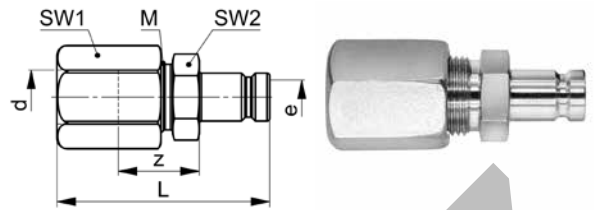

Type -DN -d	Mat.-Nr.	bar	DN	M	SW1	SW2	L	z	e	kg/100
* Q51 N04PS-4	C58.4151.040	200	04	10x1.0	12	11	28.0	11.5	3.0	1.200
* Q51 N04PS-5	C58.4151.050	200	04	10x1.0	12	11	28.0	11.5	3.0	1.190
Q51 N04PS-6	C58.4151.060	200	04	10x1.0	12	11	28.0	11.5	3.0	1.500
* Q51 N06PS-8	C58.4152.080	100	06	14x1.0	17	14	40.0	15.0	6.0	2.740
Q51 N06PS-10	C58.4152.100	100	06	14x1.0	17	14	40.0	15.0	6.0	4.170
Q51 N08PS-12	C58.4153.120	65	08	16x1.0	19	19	45.0	16.0	8.0	5.300
Q51 N10PS-15	C58.4154.150	65	10	20x1.5	24	24	52.5	21.0	10.0	10.300

Nur Typen mit dem gleichen DN (Nennweite) lassen sich miteinander kuppeln.

Seuls les types ayant le même DN (diamètre nominal) peuvent être couplés entre eux.

Only types with the same DN (nominal diameter) can be coupled together.

Stecker mit SERTO-Anschluss

absperrend

Embout avec connexion SERTO

obturant

Nipple with SERTO connection

shut-off

Q51 N..VS

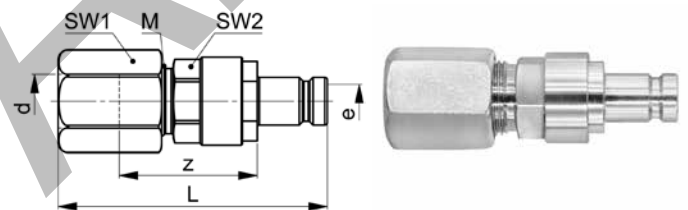

Type -DN -d	Mat.-Nr.	bar	DN	M	SW1	SW2	L	z	e	kg/100
* Q51 N06VS-8	C58.5152.080	100	06	14x1.0	17	14	51.0	26.0	6.0	3.790
Q51 N06VS-10	C58.5152.100	100	06	14x1.0	17	14	51.0	26.0	6.0	4.720
Q51 N08VS-12	C58.5153.120	65	08	16x1.0	19	19	60.5	32.0	8.0	8.300
Q51 N10VS-15	C58.5154.150	65	10	20x1.5	24	24	70.5	38.0	10.0	16.500

Nur Typen mit dem gleichen DN (Nennweite) lassen sich miteinander kuppeln.

Seuls les types ayant le même DN (diamètre nominal) peuvent être couplés entre eux.

Only types with the same DN (nominal diameter) can be coupled together.

d=Rohrassen- \emptyset
 LW=Rohrinnen- \emptyset
 e=kleinste Bohrung
 *=mit reduziertem Klemmring

d= \emptyset extérieur du tube
 LW= \emptyset intérieur du tube
 e= \emptyset -min. de passage
 *=avec bague de serrage de réduction

d=tube outside diameter
 LW=tube inside diameter
 e=minimum bore
 *=with reduction compression ferrule

Stecker mit Aussengewinde

mit Conovor O-Ringabdichtung (FKM), nicht absperrend

Embout avec filetage

avec joint torique système Conovor (FKM), non-obturant

Nipple with male thread

with Conovor O-ring seal (FKM), no shut-off

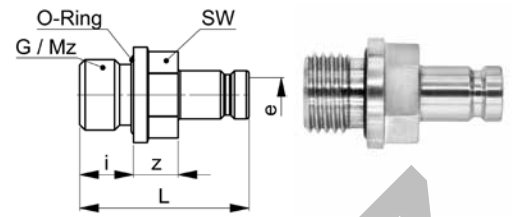

Q51 N..PM

Type -DN -G / -Mz	Mat.-Nr.	bar	DN	SW	L	i	z	O-Ring	e	kg/100
G=Rohrgewinde (zylindrisch)										
Mz=metrisches Gewinde (zylindrisch)										
Q51 N04PM-1/8 OR	C58.4451.100	200	04	12	21.0	8.0	5.0	8.73x1.78	3.0	0.840
Q51 N04PM-M5	C58.4451.155	200	04	9	16.0	4.5	3.0	-	2.5	0.300
Q51 N06PM-1/4 OR	C58.4452.270	100	06	14	31.5	10.0	8.0	11.1x1.78	6.0	1.900
Q51 N08PM-3/8 OR	C58.4453.390	65	08	19	32.0	10.0	7.0	14.0x1.78	8.0	2.600
Q51 N10PM-1/2 OR	C58.4454.534	65	10	24	41.0	12.0	11.0	18.72x2.62	10.0	6.000

Grösse M5 mit POM-Dichtscheibe.

Taille M5 avec joint en POM.

Size M5 with POM sealing washer.

Nur Typen mit dem gleichen DN (Nennweite) lassen sich miteinander koppeln.

Seuls les types ayant le même DN (diamètre nominal) peuvent être couplés entre eux.

Only types with the same DN (nominal diameter) can be coupled together.

Stecker mit Aussengewinde

mit Conovor O-Ringabdichtung (FKM), absperrend

Embout avec filetage

avec joint torique système Conovor (FKM), obturant

Nipple with male thread

with Conovor O-ring seal (FKM), shut-off

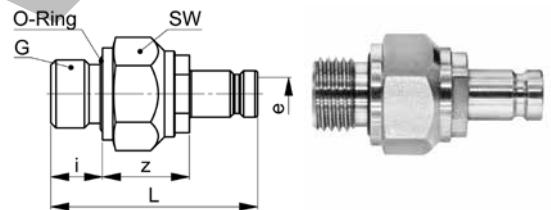

Q51 N..VM

Type -DN -G	Mat.-Nr.	bar	DN	SW	L	i	z	O-Ring	e	kg/100
G=Rohrgewinde (zylindrisch)										
Q51 N06VM-1/4 OR	C58.5452.270	100	06	19	40.0	10.0	17.0	11.1x1.78	6.0	3.520
Q51 N08VM-3/8 OR	C58.5453.390	65	08	22	47.0	10.0	22.0	14.0x1.78	8.0	6.200
Q51 N10VM-1/2 OR	C58.5454.534	65	10	27	56.0	12.0	26.0	18.72x2.62	10.0	11.900

Nur Typen mit dem gleichen DN (Nennweite) lassen sich miteinander koppeln.

Seuls les types ayant le même DN (diamètre nominal) peuvent être couplés entre eux.

Only types with the same DN (nominal diameter) can be coupled together.

d=Rohrassen-ø
LW=Rohrinnen-ø
e=kleinste Bohrung
*=mit reduziertem Klemmring

d=ø extérieur du tube
LW=ø intérieur du tube
e=ø-min. de passage
*=avec bague de serrage de réduction

d=tube outside diameter
LW=tube inside diameter
e=minimum bore
*=with reduction compression ferrule

Stecker mit Innengewinde

nicht absperrend

Embout avec taraudage

non-obturant

Nipple with female thread

no shut-off

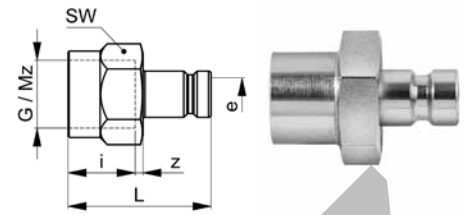

Q51 N..PF

Type -DN -G / -Mz	Mat.-Nr.	bar	DN	SW	L	i	z	e	kg/100
G=Rohrgewinde (zylindrisch)	G=Filetage-gaz BSP (cylindrique)			G=BSP thread (parallel)					
Mz=metrisches Gewinde (zylindrisch)	Mz=Filetage métrique (cylindrique)			Mz=Metric thread (parallel)					
Q51 N04PF-1/8	C56.4751.100	200	04	12	20.0	10.0	8.5	3.0	0.900
Q51 N04PF-M5	C56.4751.155	200	04	11	17.0	5.0	8.5	3.0	0.500
Q51 N06PF-1/4	C56.4752.270	100	06	17	28.0	13.0	1.5	6.0	1.800
Q51 N08PF-3/8	C56.4753.390	65	08	19	30.0	13.0	2.0	8.0	2.500
Q51 N10PF-1/2	C56.4754.534	65	10	24	37.0	16.0	3.0	10.0	4.800

Nur Typen mit dem gleichen DN (Nennweite) lassen sich miteinander koppeln.

Seuls les types ayant le même DN (diamètre nominal) peuvent être couplés entre eux.

Only types with the same DN (nominal diameter) can be coupled together.

Stecker mit Innengewinde

absperrend

Embout avec taraudage

obturant

Nipple with female thread

shut-off

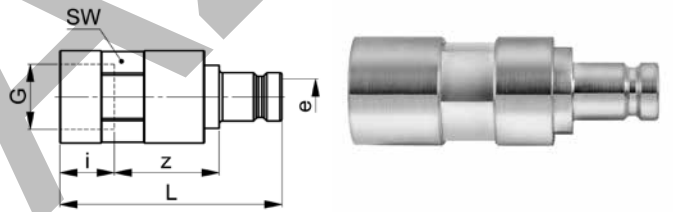

Q51 N..VF

Type -DN -G	Mat.-Nr.	bar	DN	SW	L	i	z	e	kg/100
G=Rohrgewinde (zylindrisch)	G=Filetage-gaz BSP (cylindrique)			G=BSP thread (parallel)					
Q51 N06VF-1/4	C58.5752.270	100	06	14	47.0	13.0	21.0	6.0	3.700
Q51 N08VF-3/8	C58.5753.390	65	08	19	53.0	13.0	25.0	8.0	7.400
Q51 N10VF-1/2	C58.5754.534	65	10	24	63.5	16.0	29.5	10.0	14.200

Nur Typen mit dem gleichen DN (Nennweite) lassen sich miteinander koppeln.

Seuls les types ayant le même DN (diamètre nominal) peuvent être couplés entre eux.

Only types with the same DN (nominal diameter) can be coupled together.

d=Rohrassen-ø
LW=Rohrinnen-ø
e=kleinste Bohrung
*=mit reduziertem Klemmring

d=ø extérieur du tube
LW=ø intérieur du tube
e=ø-min. de passage
*=avec bague de serrage de réduction

d=tube outside diameter
LW=tube inside diameter
e=minimum bore
*=with reduction compression ferrule

Stecker mit Schlauchtülle

nicht absperrend

Embout avec douille cannelée pour tuyau

non-obturant

Nipple with hose nozzle

no shut-off

Q51 N..PN

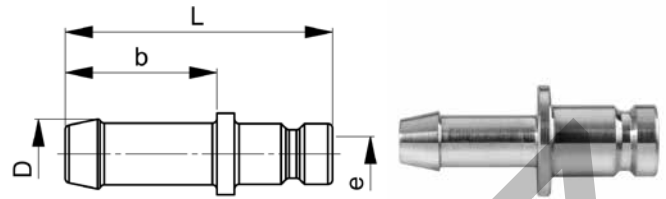

Type -DN -LW	Mat.-Nr.	bar	DN	L	D	b	e	kg/100
Q51 N04PN-LW4 (6/4)	C56.4651.040	200	04	21.0	5.0	11.0	3.0	0.190
Q51 N04PN-LW5 (8/5)	C56.4651.050	200	04	23.0	6.0	13.0	3.0	0.230
Q51 N06PN-LW6 (8/6)	C56.4652.060	100	06	32.0	7.5	17.0	4.0	0.760
Q51 N06PN-LW8 (10/8)	C56.4652.080	100	06	32.0	9.5	17.0	6.4	0.780
Q51 N08PN-LW8 (10/8)	C56.4653.080	65	08	34.0	9.5	17.0	6.0	1.300
Q51 N08PN-LW10 (12/10)	C56.4653.100	65	08	36.0	11.5	19.0	8.5	1.300

Nur Typen mit dem gleichen DN (Nennweite) lassen sich miteinander koppeln.

Seuls les types ayant le même DN (diamètre nominal) peuvent être couplés entre eux.

Only types with the same DN (nominal diameter) can be coupled together.

d=Rohrassen-ø
LW=Rohrinnen-ø
e=kleinste Bohrung
*=mit reduziertem Klemmring

d=ø extérieur du tube
LW=ø intérieur du tube
e=ø-min. de passage
*=avec bague de serrage de réduction

d=tube outside diameter
LW=tube inside diameter
e=minimum bore
*=with reduction compression ferrule

Kupplungen Inox Serie H

Materialien Serie H

- Kuppler und Stecker: Edelstahl 1.4401
- Dichtungen: FKM (Standard)
andere auf Anfrage

Nennweite

1/4" - 1 1/2"; DN6 - DN40

Betriebstemperatur

FKM: -20°C bis +200°C

Betriebsdruck

105 bis 690 bar bei +23°C

Kupplungsfunktionen

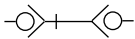

beidseitig absperrend
Kuppler absperrend S-VHC
Stecker absperrend S-VHN

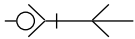

einseitig absperrend
Kuppler absperrend S-VHC
Stecker nicht absperrend S-PHN

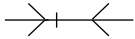

nicht absperrend
Kuppler nicht absperrend S-PHC
Stecker nicht absperrend S-PHN

Eigenschaften

- schnelle und einfache Bedienung
- spezielles "Jet-Stream" Ventil sorgt für geringen Strömungswiderstand
- gleichmässiger Durchfluss
- sehr niedriger Druckverlust

Merkmale

- Einsatz: Hydraulik, Pneumatik
- Medien: Flüssigkeiten, Gase

Durchflussleistung

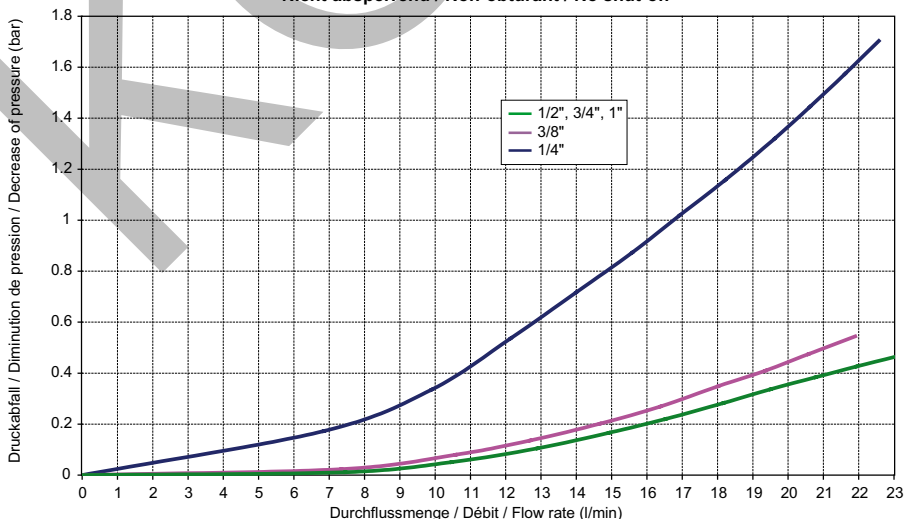

Coupleurs inox série H

Matériaux séries H

- Coupleur et embout: acier inoxydable 1.4401
- Joints: KFM (standard)
autres sur demande

Largeur nominale

1/4" - 1 1/2"; DN6 - DN40

Plage de température

FKM: -20°C à +200°C

Pression de service

105 à 690 bar à +23°C

Fonctions d'accouplement

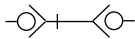

obturant dans les deux sens
coupleur obturant S-VHC
embout obturant S-VHN

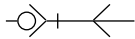

obturant dans un sens
coupleur obturant S-VHC
embout non-obturant S-PHN

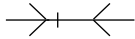

non-obturant
coupleur non-obturant S-PHC
embout non-obturant S-PHN

Propriétés

- utilisation simple et rapide
- soupape spécial "jet-stream" assure une faible résistance à l'écoulement
- débit constant
- très peu de pertes de pression

Caractéristiques

- Application: hydraulique, pneumatique
- Médium: fluides, gaz

Débit

Couplings inox series H

Materials series H

- Coupler and nipple: stainless steel 1.4401
- Seals: FKM (standard)
others on request

Nominal bore

1/4" - 1 1/2"; DN6 - DN40

Temperature range

FKM: -20°C to +200°C

Working pressure

105 to 690 bar at +23°C

Coupling functions

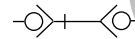

double-sided shut-off
coupler shut-off S-VHC
nipple shut-off S-VHN

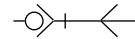

one-sided shut-off
coupler shut-off S-VHC
nipple no shut-off S-PHN

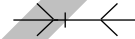

no shut-off
coupler no shut-off S-PHC
nipple no shut-off S-PHN

Properties

- fast and easy to use
- special "jet stream" valve for low flow resistance
- steady flow
- very little pressure loss

Characteristics

- Uses: hydraulic and pneumatic systems
- Media: fluids, gases

Flow capacity



Einseitig absperrend / Obturant dans un sens / One-sided shut-off

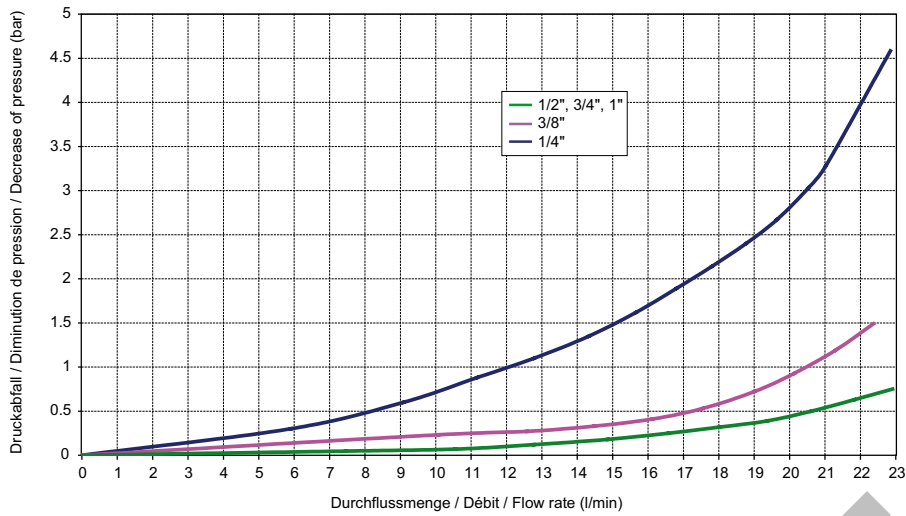

Beidseitig absperrend / Obturant dans les deux sens / Double-sided shut-off

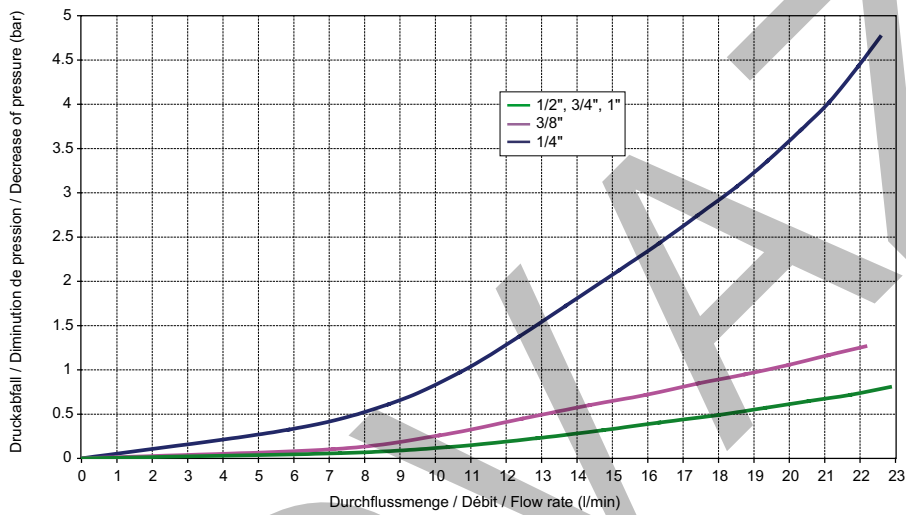

Lieferhinweis

Kupplungen können aus Sechskantmaterial oder aus Rundmaterial mit zwei gefrästen Flächen hergestellt sein.

Note à la livraison

Les accouplements peuvent être réalisés en matériau hexagonal ou en matériau rond avec deux surfaces fraisées.

Note on delivery

Couplings can be made of hexagonal material or of round material with two milled sides.

Kuppler mit Innengewinde

nicht absperrend

Coupleur avec taraudage

non-obturant

Coupler with female thread

no shut-off

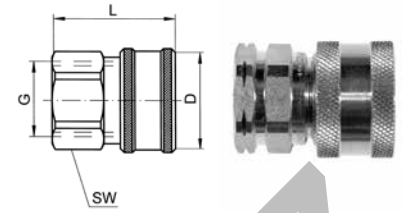

S-PHC

Type -G	Mat.-Nr.	bar	SW	L	D	kg/100
G=Rohrgewinde (zylindrisch)	G=Filetage-gaz BSP (cylindrique)			G=BSP thread (parallel)		
S-PHC4-G $\frac{1}{4}$ i-FKM	YBD.OH51.1042	690	22	34.0	25.4	7.700
S-PHC6-G $\frac{3}{8}$ i-FKM	YBD.OH51.1062	555	25	38.1	30.2	11.500
S-PHC8-G $\frac{1}{2}$ i-FKM	YBD.OH51.1082	555	30	41.2	35.3	15.500
S-PHC12-G $\frac{3}{4}$ i-FKM	YBD.OH51.1092	485	38	48.5	41.4	25.000
S-PHC16-G1 i-FKM	YBD.OH51.1102	280	47	52.6	50.8	41.800
S-PHC24-G1 $\frac{1}{2}$ i-FKM	YBD.OH51.1182	210	63	65.3	69.9	99.000

14

Kuppler mit Innengewinde

absperrend

Coupleur avec taraudage

obturant

Coupler with female thread

shut-off

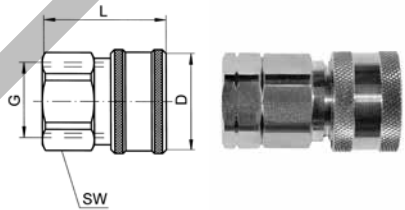

S-VHC

Type -G	Mat.-Nr.	bar	SW	L	D	kg/100
G=Rohrgewinde (zylindrisch)	G=Filetage-gaz BSP (cylindrique)			G=BSP thread (parallel)		
S-VHC4-G $\frac{1}{4}$ i-FKM	YBD.OH52.1042	345	22	41.9	25.4	10.000
S-VHC6-G $\frac{3}{8}$ i-FKM	YBD.OH52.1062	280	25	48.3	30.2	14.800
S-VHC8-G $\frac{1}{2}$ i-FKM	YBD.OH52.1082	260	30	53.1	35.3	20.500
S-VHC12-G $\frac{3}{4}$ i-FKM	YBD.OH52.1092	140	38	61.5	41.4	33.800
S-VHC16-G1 i-FKM	YBD.OH52.1102	140	47	67.8	50.8	53.600
S-VHC20-G1 $\frac{1}{4}$ i-FKM	YBD.OH52.1142	105	50	89.9	57.2	72.500

Stecker mit Innengewinde

nicht absperrend

Embout avec taraudage

non-obturant

Nipple with female thread

no shut-off

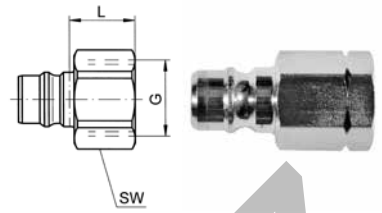

S-PHN

Type -G	Mat.-Nr.	bar	SW	L	kg/100
G=Rohrgewinde (zylindrisch)	G=Filetage-gaz BSP (cylindrique)			G=BSP thread (parallel)	
S-PHN4-G $\frac{1}{4}$ i	YBD.OH53.1040	690	16	18.5	2.100
S-PHN6-G $\frac{3}{8}$ i	YBD.OH53.1060	555	20	20.3	3.500
S-PHN8-G $\frac{1}{2}$ i	YBD.OH53.1080	555	25	25.4	7.100
S-PHN12-G $\frac{3}{4}$ i	YBD.OH53.1090	485	30	26.1	9.300
S-PHN16-G1 i	YBD.OH53.1100	280	38	30.2	16.500
S-PHN20-G1 $\frac{1}{4}$ i	YBD.OH53.1140	210	47	33.0	28.000
S-PHN24-G1 $\frac{1}{2}$ i	YBD.OH53.1180	210	54	34.3	40.500

Stecker mit Innengewinde

absperrend

Embout avec taraudage

obturant

Nipple with female thread

shut-off

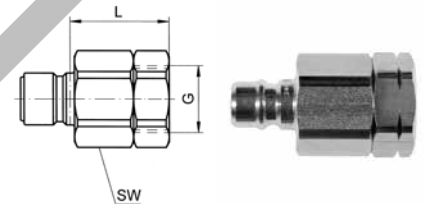

S-VHN

Type -G	Mat.-Nr.	bar	SW	L	kg/100
G=Rohrgewinde (zylindrisch)	G=Filetage-gaz BSP (cylindrique)			G=BSP thread (parallel)	
S-VHN4-G $\frac{1}{4}$ i-FKM	YBD.OH54.1042	345	22	25.4	6.900
S-VHN6-G $\frac{3}{8}$ i-FKM	YBD.OH54.1062	280	25	28.4	8.900
S-VHN8-G $\frac{1}{2}$ i-FKM	YBD.OH54.1082	260	30	32.0	13.700
S-VHN12-G $\frac{3}{4}$ i-FKM	YBD.OH54.1092	140	38	35.6	23.200
S-VHN16-G1 i-FKM	YBD.OH54.1102	140	47	41.7	32.000
S-VHN20-G1 $\frac{1}{4}$ i-FKM	YBD.OH54.1142	105	50	63.2	50.000

Kupplungen Inox Serie 25

Coupleurs inox série 25

Couplings inox series 25

Materialien Serie 25

- Kuppler und Stecker: Edelstahl 1.4401
- Dichtungen:
Kuppler: KEL-F
Stecker: PTFE

Nennweite

1/4" - 1/2"; DN6 - DN12

Betriebstemperatur

entkuppelt: -73°C bis +150°C
gekuppelt: -240°C bis +150°C

Betriebsdruck

70 bar bei +23°C

Kupplungsfunktionen

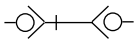

beidseitig absperrend
Kuppler absperrend S-V25C
Stecker absperrend S-V25N

Eigenschaften

- minimaler Druckabfall
- zuverlässige Kugelabsper-Armatur
- röhrenförmige Ventilkonstruktion

Merkmale

- Einsatz: Chemie
- Medien: stark ätzende Stoffe, Kohlenwasserstoffe, Ester, Ether, Ketone

Durchflussleistung

Matériaux séries 25

- Coupleur et embout: acier inoxydable 1.4401
- Joints:
- Coupleur: KEL-F
- Embout: PTFE

Largeur nominale

1/4" - 1/2"; DN6 - DN12

Plage de température

découplé: -73°C à +150°C
accouplé: -240°C à +150°C

Pression de service

70 bar à +23°C

Fonctions d'accouplement

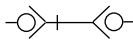

obturant dans les deux sens
coupleur obturant S-V25C
embout obturant S-V25N

Propriétés

- perte de pression minimale
- fiable raccord à bille d'arrêt
- construction tubulaire du soupape

Caractéristiques

- Application: industrie chimique
- Médium: substances très corrosifs, hydrocarbures, esters, éthers, cétones

Débit

Materials series 25

- Coupler and nipple: stainless steel 1.4401
- Seal:
- Coupler: KEL-F
- Nipple: PTFE

Nominal bore

1/4" - 1/2"; DN6 - DN12

Temperature range

uncoupled: -73°C to +150°C
coupled: -240°C to +150°C

Working pressure

70 bar at +23°C

Coupling functions

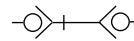

double-sided shut-off
coupler shut-off S-V25C
nipple shut-off S-V25N

Properties

- minimum pressure drop
- reliable shut-off ball fitting
- tubular valve construction

Characteristics

- Uses: chemical industry
- Media: highly corrosive substances, hydrocarbons, esters, ethers, ketones

Flow capacity

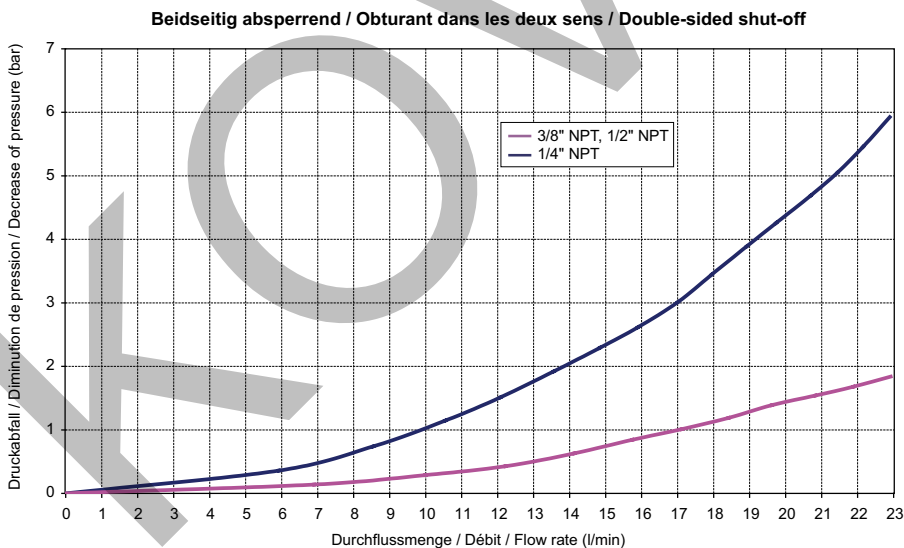

Kuppler mit Innengewinde NPT

absperrend

Coupleur avec taraudage NPT

obturant

Coupler with female thread NPT

shut-off

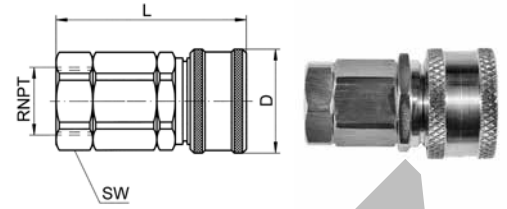

S-V25C-NPT

Type -RNPT	Mat.-Nr.	bar	SW	L	D	kg/100
RNPT=NPT Gewinde	RNPT=Filetage NPT			RNPT=NPT thread		
S-V25C4-1/4 NPSi-KEL-F	YBD.2552.2046	70	22	51.0	30.2	25.000
S-V25C8-3/8 NPSi-KEL-F RED	YBD.2552.2066	70	30	63.5	35.0	25.800
S-V25C8-1/2 NPSi-KEL-F	YBD.2552.2086	70	30	63.5	35.0	25.600

Stecker mit Innengewinde NPT

absperrend

Embout avec taraudage NPT

obturant

Nipple with female thread NPT

shut-off

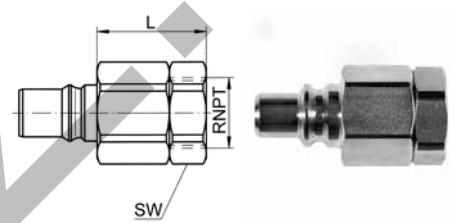

S-V25N-NPT

Type -RNPT	Mat.-Nr.	bar	SW	L	kg/100
RNPT=NPT Gewinde	RNPT=Filetage NPT			RNPT=NPT thread	
S-V25N4-1/4 NPSi-PTFE	YBD.2554.2045	70	22	25.0	7.900
S-V25N8-3/8 NPSi-PTFE RED	YBD.2554.2065	70	30	35.0	15.000
S-V25N8-1/2 NPSi-PTFE	YBD.2554.2085	70	30	35.0	15.700

Schutzkappe / Schutzstecker

für Schnellkupplungen Serien EA/E, H, 72, 25

Capuchon de protection / embout

pour coupleurs rapides séries EA/E, H, 72, 25

Protection cap / plug

for quick couplings series EA/E, H, 72, 25



PDCP

Type -d	Mat.-Nr.	kg/100
PDCP-4 (1/4)	YBD.OH99.0040	1.070
PDCP-6 (3/8)	YBD.OH99.0060	1.430
PDCP-8 (1/2)	YBD.OH99.0080	1.730
PDCP-12 (3/4)	YBD.OH99.0090	3.080
PDCP-16 (1)	YBD.OH99.0100	4.310

14

Dichtungsset

für Schnellkupplungen Serie H

Set de joint

pour coupleurs rapides série H

Gasket set

for quick couplings series H



H...-56-9

Type	Mat.-Nr.	kg/100
H 4-56-9 NBR O-Ring + Backup Ring (1/4)	YBD.OH07.0040	0.124
H 6-56-9 NBR O-Ring + Backup Ring (3/8)	YBD.OH07.0060	0.130
H 8-56-9 NBR O-Ring + Backup Ring (1/2)	YBD.OH07.0080	0.195
H 12-56-9 NBR O-Ring + Backup Ring (3/4)	YBD.OH07.0090	0.245
H 16-56-9 NBR O-Ring + Backup Ring (1)	YBD.OH07.0100	0.300

Kompakt und hoher Durchfluss – Edelstahl Schnellkupplung SERTO Flow Serie 51

Die Kupplung **SERTO Flow Serie 51** ist aus Edelstahl 1.4571 gefertigt und mit FDA-konformen FKM-Dichtungen ausgerüstet. Durch das edle und ergonomische Design liegt sie optimal in der Hand womit Fehlbedienungen praktisch ausgeschlossen sind. Dank der neuen, innovativen Ventilkonstruktion wird eine hohe Durchflussrate bei geringem Druckabfall erreicht.

Compact et haut débit – les coupleurs rapides en acier inoxydable SERTO Flow série 51

Le coupleur **SERTO Flow série 51** est en acier inoxydable 1.4571 et équipé de joints FKM conformes à la FDA. Son design élégant et ergonomique tient parfaitement dans la main, rendant les erreurs de manipulation pratiquement impossibles. Grâce à la nouvelle conception innovante de la soupape, un débit élevé est obtenu avec une faible perte de charge.

Compact and high flow rate – the stainless steel quick coupling SERTO Flow Series 51

The **SERTO Flow Series 51** coupling is made of stainless steel 1.4571 and equipped with FDA-compliant FKM seals. Its elegant and ergonomic design fits perfectly in the hand, making operating errors practically impossible. Thanks to the new, innovative valve design, a high flow rate is achieved with low pressure drop.



Sortiment:

- Kuppler mit SERTO-Anschluss, absperrend
- Kuppler in Schottausführung mit SERTO-Anschluss, absperrend
- Kuppler mit Aussengewinde, absperrend
- Kuppler mit Innengewinde, absperrend
- Stecker mit SERTO-Anschluss, absperrend/nicht absperrend
- Stecker mit Aussengewinde, absperrend/nicht absperrend
- Stecker mit Innengewinde, absperrend/nicht absperrend
- Stecker mit Schlauchtülle, nicht absperrend

Weitere Informationen finden Sie ab Seite 609.

Gamme de produits:

- Coupleur avec raccord SERTO, obturant
- Coupleur passage de cloison avec raccord SERTO, obturant
- Coupleur avec filetage, obturant
- Coupleur avec taraudage, obturant
- Embout avec connexion SERTO, obturant/non-obturant
- Embout avec filetage, obturant/non-obturant
- Embout avec taraudage, obturant/non-obturant
- Embout avec douille cannelée pour tuyau, non-obturant

Vous trouvez plus d'information à partir de la page 609.

Range of products:

- Coupler with SERTO connection, shut-off
- Panel mount coupler with SERTO connection, shut-off
- Coupler with male thread, shut-off
- Coupler with female thread, shut-off
- Nipple with SERTO connection, shut-off/no shut-off
- Nipple with male adaptor thread, shut-off/no shut-off
- Nipple with female adaptor thread, shut-off/no shut-off
- Nipple with hose nozzle, no shut-off

You find all information starting from page 609.

Stecktüllen

Messing CV, PVDF

Douilles cannelées

Laiton CV, PVDF

Hose nipples

Brass CV, PVDF



Seite/Page/Page

Seite/Page/Page

Seite/Page/Page

Stecktüllen Messing CV
Douilles cannelées laiton CV
Hose nipples brass CV

Kreuz-Tülle
 Douille en croix
 Cross hose nozzle

657



LO CV 4000

Stecktüllen PVDF
Douilles cannelées PVDF
Hose nipples PVDF

Gerade Tülle
 Douille droite double
 Straight hose nozzle

654



LO CV 1000

Sonderausführungen auf Anfrage
Exécution en option sur demande
Optional services on request



Spezialreinigung - entfettet
 Traitement spécial - dégraissé
 Special treatment - degreased

Gerade Tülle reduziert
 Douille droite double réduite
 Straight hose nozzle reduced

654



LO CV 1000 RED

Tülle mit Schottbefestigung
 Douille traversée de cloison
 Panel mount hose nozzle

654



LO CV 1500

Tülle mit Schottbefestigung reduziert
 Douille traversée de cloison réduite
 Panel mount hose nozzle reduced

655



LO CV 1500 RED

Einschraubtülle
 Douille cannelée à visser
 Male adaptor hose nozzle

655-656



LO CV 1100

Winkelverteiler 60°
 Distributeur 60°
 Distributor 60°

656



LO CV 3000 60

T-Tülle
 Douille en té
 Tee hose nozzle

657



LO CV 3000 T

Gerade Tülle
 Douille droite double
 Straight hose nozzle

658



LO PVDF 1000

Gerade Tülle reduziert
 Douille droite double réduite
 Straight hose nozzle reduced

658



LO PVDF 1000 RED

Winkel-Tülle
 Douille coudé
 Elbow hose nozzle

658



LO PVDF 2000

T-Tülle
 Douille en té
 Tee hose nozzle

658



LO PVDF 3000

Winkel-Tülle 60°
 Douille coudé 60°
 Y hose nozzle

659



LO PVDF 3000 Y

Stecktüllen

Eigenschaften, Besonderheiten

- einfache und schnelle Montage
- platzsparend
- grosse Sortimentsvielfalt:
 - leichte Kunststoffausführung
 - durchflussoptimierte Messingausführung
- preisgünstig

Anwendung

Zur Verbindung von Schläuchen z.B. in Mess- und Regeltechnik, Labor, Apparatebau, etc.

Rohre

Geeignet sind Rohre und Schläuche deren Werkstoffe genügend Elastizität aufweisen, um die Aufweitung auf Dauer schadlos zu vertragen, z.B. Polyurethan, Polyamid, PVC, Gummi.

Werkstoff

- Messing vernickelt
- Kunststoff PVDF

Betriebsdruck PN

Zulässiger Betriebsdruck bis PN 6 nach DIN EN 1333. Die anwendbaren Betriebsdrücke hängen von den verwendeten Schläuchen ab. Bei höheren Belastungen oder ungenügender Spannkraft des Schlauches sind zusätzliche Befestigungen erforderlich, z.B. Schlauchschellen (siehe Kapitel 21).

Douilles cannelées

Propriétés, spécificités

- connexions simples et vites
- peu encombrants
- grande diversité de l'assortiment :
 - exécution ténue en plastique
 - exécution en laiton avec coefficient de débit optimisé
- avantageux

Application

Pour connexion des tubes dans des systèmes de mesure et de réglage, dans des laboratoires et dans la construction d'appareils, etc.

Tubes

Utilisables sont des tuyaux à condition que le matériau présente une élasticité suffisante pour pouvoir supporter l'élargissement sans dommage, p.ex. des tubes en polyamide, polyuréthane, PVC, caoutchouc.

Matériaux

- laiton nickélé
- plastique PVDF

Pression de service PN

Pression de service admissible jusqu'à PN 6 bars selon DIN EN 1333. Les pressions de service dépendent du type de tube utilisé. Lorsque les sollicitations sont élevées ou si le tuyau ne présente pas une élasticité suffisante, il est nécessaire de prévoir un dispositif de fixation supplémentaire, p.ex. des colliers de fixation (voir chapitre 21).

Hose nipples

Characteristics, specialities

- simple and fast connections
- space-saving
- large product line:
 - lightweight plastics
 - brass, flow-optimized
- inexpensive

Application

For tube connection in gauging and regulating systems, laboratories, apparatus manufacturing, etc.

Tubing

Suitable are tubes where the material is sufficiently elastic to stretch for an adequate length of time without suffering damage, i.e. polyurethan, polyamide, PVC, rubber.

Material

- nickel plated brass
- plastic PVDF

Working pressure PN

Admissible working pressure up to PN 6 acc. to DIN EN 1333. The applicable operating pressure will depend on the tube used. Under high load conditions or where the natural elasticity of the tube is insufficient, additional fixtures, e.g. hose clips, may be necessary (see chapter 21).

Gerade Tülle

Douille droite double

Straight hose nozzle

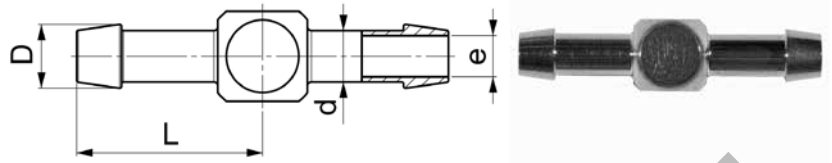

LO CV 1000

Type-d	Mat.-Nr.	L	D	e	kg/100
LO CV 1000-1,5	366.1000.015	8.0	2.0	1.0	0.060
LO CV 1000-2	366.1000.020	9.0	2.5	1.4	0.070
LO CV 1000-2,5	366.1000.025	10.5	3.0	1.9	0.120
LO CV 1000-3	366.1000.030	12.0	3.7	2.3	0.060
LO CV 1000-4	366.1000.040	14.5	5.0	3.2	0.325

Gerade Tülle reduziert

Douille droite double réduite

Straight hose nozzle reduced

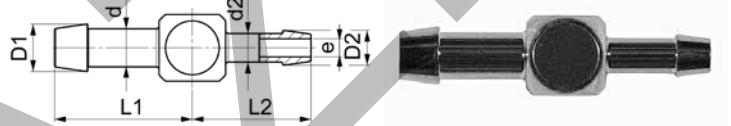

LO CV 1000 RED

Type-d-d2	Mat.-Nr.	L1	L2	D1	D2	e	kg/100
LO CV 1000-2-1,5	366.1004.013	9.0	8.0	2.5	2.0	1.0	0.060
LO CV 1000-2,5-1,5	366.1004.010	10.5	8.5	3.0	2.0	1.0	0.110
LO CV 1000-2,5-2	366.1004.012	10.5	9.5	3.0	2.5	1.4	0.110
LO CV 1000-3-1,5	366.1004.014	12.0	9.0	3.7	2.0	1.0	0.180
LO CV 1000-3-2	366.1004.020	12.0	10.0	3.7	2.5	1.4	0.180
LO CV 1000-4-1,5	366.1004.028	14.5	9.5	5.0	2.0	1.0	0.290
LO CV 1000-4-2	366.1004.030	14.5	10.5	5.0	2.5	1.4	0.300
LO CV 1000-4-2,5	366.1004.035	14.5	11.5	5.0	3.0	1.9	0.310
LO CV 1000-4-3	366.1004.040	14.5	12.5	5.0	3.7	2.3	0.320

Tülle mit Schottbefestigung

Douille traversée de cloison

Panel mount hose nozzle

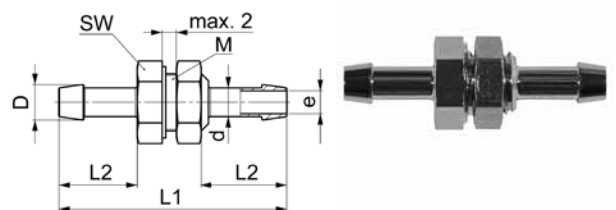

LO CV 1500

Type-d	Mat.-Nr.	M	SW	L1	L2	D	e	kg/100
LO CV 1500-1,5	366.1500.006	M5	7	20.0	6.0	2.0	1.0	0.240
LO CV 1500-2	366.1500.020	M5	7	22.0	7.0	2.5	1.4	0.240
LO CV 1500-2,5	366.1500.030	M5	7	24.0	8.0	3.0	1.9	0.250
LO CV 1500-3	366.1500.050	M5	7	26.0	9.0	3.7	2.3	0.260
LO CV 1500-4	366.1500.090	M8x1	10	32.0	11.0	5.0	3.2	0.670
LO CV 1500-4 (G 1/8)	366.1501.060	G 1/8	12	34.0	11.0	5.0	3.2	1.060

Tülle mit Schottbefestigung reduziert

Douille traversée de cloison réduite

Panel mount hose nozzle reduced

LO CV 1500 RED

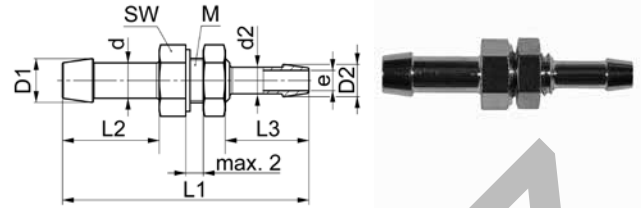

Type - d - d2	Mat.-Nr.	M	SW	L1	L2	L3	D1	D2	e	kg/100
LO CV 1500-2-1,5	366.1504.013	M5	7	21.0	7.0	6.0	2.5	2.0	1.0	0.240
LO CV 1500-3-1,5	366.1504.014	M5	7	23.0	9.0	6.0	3.7	2.0	1.0	0.240
LO CV 1500-4-1,5	366.1504.028	M5	7	25.0	11.0	6.0	5.0	2.0	1.0	0.250
LO CV 1500-4-2	366.1504.030	M5	7	26.0	11.0	7.0	5.0	2.5	1.4	0.260
LO CV 1500-4-2,5	366.1504.035	M5	7	27.0	11.0	8.0	5.0	3.0	1.9	0.270
LO CV 1500-4-3	366.1504.040	M5	7	28.0	11.0	9.0	5.0	3.7	2.3	0.290

Einschraubtülle

Douille cannelée à visser

Male adaptor hose nozzle

LO CV 1100

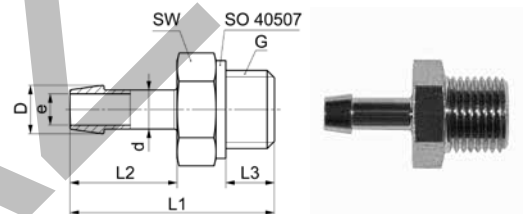

Type - d - G	Mat.-Nr.	SW	L1	L2	L3	D	e	kg/100
G=Rohrgewinde (zylindrisch)	G=Filetage-gaz BSP (cylindrique)	G=BSP thread (parallel)						
LO CV 1100-1,5-1/8	366.1141.009	12	18.0	6.0	8.0	2.0	1.0	0.640
LO CV 1100-2-1/8	366.1141.020	12	19.0	7.0	8.0	2.5	1.4	0.840
LO CV 1100-2,5-1/8	366.1141.030	12	20.0	8.0	8.0	3.0	1.9	0.775
LO CV 1100-3-1/8	366.1141.040	12	23.0	9.0	8.0	3.7	2.3	0.825
LO CV 1100-4-1/8	366.1141.060	12	23.0	11.0	8.0	5.0	3.2	0.810

Die entsprechende Dichtung SO 40507 ist separat zu bestellen.

Le joint correspondant SO 40507 doit être commandé séparément.

The relevant washer SO 40507 must be ordered separately.

Einschraubtülle METR

Douille cannelée à visser METR

Male adaptor hose nozzle METR

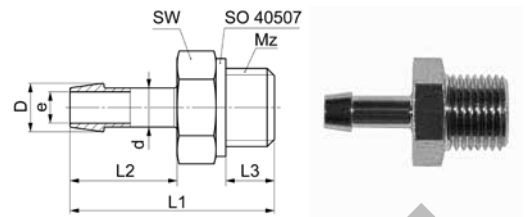

LO CV 1100 METR

Type -d -Mz	Mat.-Nr.	SW	L1	L2	L3	D	e	kg/100
Mz=metrisches Gewinde (zylindrisch)		Mz=Filetage métrique (cylindrique)			Mz=Metric thread (parallel)			
LO CV 1100-1,5-M5	366.1143.006	7	14.0	6.0	4.5	2.0	1.0	0.170
LO CV 1100-2-M5	366.1143.020	7	15.0	7.0	4.5	2.5	1.4	0.190
LO CV 1100-2,5-M5	366.1143.030	7	16.0	8.0	4.5	3.0	1.9	0.185
LO CV 1100-3-M5	366.1143.050	7	17.0	9.0	4.5	3.7	2.3	0.200
LO CV 1100-4-M5	366.1143.080	7	19.0	11.0	4.5	5.0	2.5	0.210
LO CV 1100-1,5-M8x1	366.1143.011	10	16.0	6.0	6.0	2.0	1.0	0.490
LO CV 1100-2-M8x1	366.1143.035	10	17.0	7.0	6.0	2.5	1.4	0.480
LO CV 1100-2,5-M8x1	366.1143.043	10	18.0	8.0	6.0	3.0	1.9	0.440
LO CV 1100-3-M8x1	366.1143.060	10	19.0	9.0	6.0	3.7	2.3	0.500
LO CV 1100-4-M8x1	366.1143.090	10	21.0	11.0	6.0	5.0	3.2	0.460

Die entsprechende Dichtung SO 40507 ist separat zu bestellen.

Le joint correspondant SO 40507 doit être commandé séparément.

The relevant washer SO 40507 must be ordered separately.

Winkelverteiler 60°

Distributeur 60°

Distributor 60°

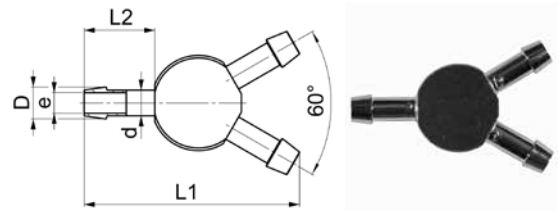

LO CV 3000 60

Type -d	Mat.-Nr.	L1	L2	D	e	kg/100
LO CV 3000-1,5-Y60°	366.5000.015	16.0	5.5	2.0	1.0	0.080
LO CV 3000-2-Y60°	366.5000.020	19.5	7.0	2.5	1.4	0.120
LO CV 3000-2,5-Y60°	366.5000.025	23.5	8.0	3.0	1.9	0.260
LO CV 3000-3-Y60°	366.5000.030	27.5	9.0	3.7	2.3	0.350
LO CV 3000-4-Y60°	366.5000.040	34.0	11.0	5.0	3.2	0.660

T-Tülle

Douille en té

Tee hose nozzle

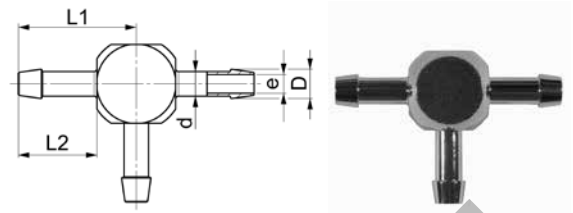

LO CV 3000 T

Type -d	Mat.-Nr.	L1	L2	D	e	kg/100
LO CV 3000-1,5	366.3000.015	8.0	6.0	2.0	1.0	0.060
LO CV 3000-2	366.3000.020	9.0	7.0	2.5	1.4	0.092
LO CV 3000-2,5	366.3000.025	11.0	8.0	3.0	1.9	0.150
LO CV 3000-3	366.3000.030	12.0	9.0	3.7	2.3	0.235
LO CV 3000-4	366.3000.040	14.5	11.0	5.0	3.2	0.375

Kreuz-Tülle

Douille en croix

Cross hose nozzle

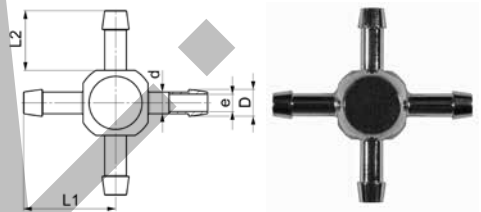

LO CV 4000

Type -d	Mat.-Nr.	L1	L2	D	e	kg/100
LO CV 4000-1.5	366.4000.015	8.0	6.0	2.0	1.0	0.070
LO CV 4000-2	366.4000.020	9.0	7.0	2.5	1.4	0.085
LO CV 4000-2,5	366.4000.025	10.5	8.0	3.0	1.9	0.175
LO CV 4000-3	366.4000.030	12.0	9.0	3.7	2.3	0.280
LO CV 4000-4	366.4000.040	14.5	11.0	5.0	3.2	0.435

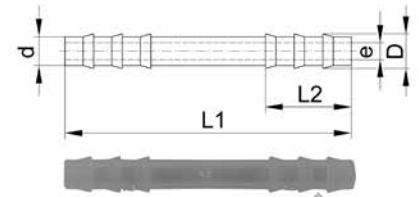
Gerade Tülle
Douille droite double
Straight hose nozzle

LO PVDF 1000

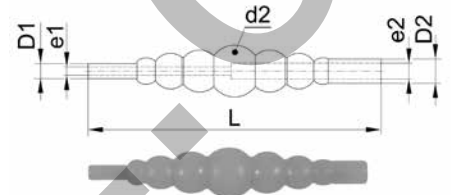
Type-d	Mat.-Nr.	L1	L2	D	e
LO PVDF 1000-4	366.1001.040	40.0	12.0	4.8	2.4
LO PVDF 1000-6	366.1001.060	49.0	12.0	6.8	3.9

Gerade Tülle reduziert
Douille droite double réduite
Straight hose nozzle reduced

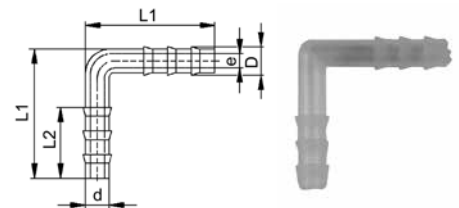
LO PVDF 1000 RED

Type-d-d2	Mat.-Nr.	L	D1	D2	e1	e2
LO PVDF 1000-4-17	366.1005.047	96.5	5.0	8.0	2.8	5.2

Winkel-Tülle
Douille coude
Elbow hose nozzle

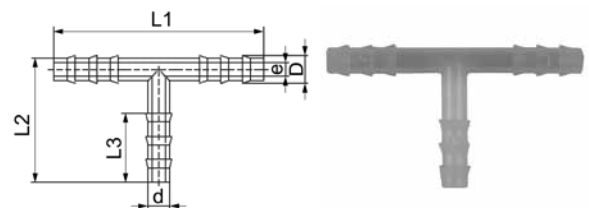
LO PVDF 2000

Type-d	Mat.-Nr.	L1	L2	D	e
LO PVDF 2000-4	366.2001.040	21.5	10.5	4.8	2.7
LO PVDF 2000-6	366.2001.060	28.0	14.0	6.8	3.9

T-Tülle
Douille en té
Tee hose nozzle

LO PVDF 3000

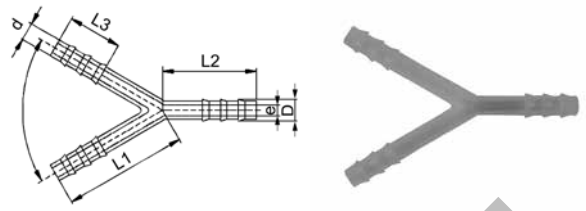
Type-d	Mat.-Nr.	L1	L2	L3	D	e
LO PVDF 3000-4	366.3001.040	39.0	21.5	10.5	4.8	2.7
LO PVDF 3000-6	366.3001.060	50.0	30.0	14.0	6.8	3.9

Winkel-Tülle 60°
Douille coudé 60°
Y hose nozzle



LO PVDF 3000 Y

Type -d	Mat.-Nr.	L1	L2	L3	D	e
LO PVDF 3000-4-Y60°	366.5001.040	28.0	21.0	10.5	4.8	2.7
LO PVDF 3000-6-Y60°	366.5001.060	31.5	25.0	14.0	6.8	3.9

KOLVANZIC

Unsere Unterstützung bei Ihrer Montage

Wenn Sie zum ersten Mal SERTO-Verschraubungen montieren wollen, dann sind Montageschulungen genau das Richtige für Sie. Einer unserer Aussendienstmitarbeiter wird Ihnen in Ihrem Hause zeigen, wie SERTO Verschraubungen richtig montiert werden. Danach verpressen Sie Klemmringe in Messing oder Edelstahl manuell und mit maschineller Unterstützung. Sie lernen, worauf Sie bei der Montage achten sollten, und erfahren einige Kniffe und Tricks, die die Montage noch effizienter und sicherer machen. Das gibt Ihnen Sicherheit im Umgang mit unseren Verschraubungen. Nach der Schulung erhalten Sie ein Handout zum Nachschlagen und ein Zertifikat.

Natürlich können Sie auch gern zu uns nach Frauenfeld kommen. Im Rahmen einer Produkteschulung oder speziell für eine Montageschulung.

Kontaktieren Sie uns einfach!

Assistance au montage

Si vous souhaitez utiliser pour la première fois des raccords SERTO, les formations au montage sont exactement ce dont vous avez besoin. L'un de nos formateurs vous montrera sur site comment monter de façon optimale nos raccords, manuellement ou bien avec un outillage. Vous apprendrez les astuces et points importants afin de réaliser un montage de qualité. A l'issue de la formation vous vous verrez remettre un manuel d'application des raccords SERTO ainsi qu'un certificat de formation.

Cette formation peut aussi avoir lieu chez nous à Frauenfeld, que ce soit dans le cadre d'une formation produit ou uniquement pour une formation au montage.

N'hésitez pas à nous contacter!

Support for your assembly

If you are assembling SERTO unions for the first time, our assembly training is just the thing for you. One of our sales employees will show you how to correctly assemble SERTO unions on your premises. After that you can process brass or stainless steel compression ferrules manually or with the aid of machinery. You will learn what to pay attention to during assembly and will be shown tricks and hints to make assembly even safer and more efficient. This gives you confidence in the use of our unions. After the training you will receive a handout for reference and a certificate.

Of course, you are welcome to come to us in Frauenfeld for a product training or an assembly training.

Just contact us!



Adapter

Messing, Edelstahl,
PVDF, PA

Adaptateurs



















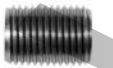

Laiton, acier inoxydable,
PVDF, PA

Adaptors

Brass, stainless steel,
PVDF, PA



	Seite/Page/Page		Seite/Page/Page		Seite/Page/Page
Adapter Messing M Adaptateurs laiton M Adaptors brass M		Aufschraub-T Té femelle Female threaded tee	674		Adapter Messing G Adaptateurs laiton G Adaptors brass G
				AD FT 40	
Doppelnippel Mamelon double Male threaded adaptor	666-667	Einschraubtülle Douille cannelée à visser Male adaptor hose nozzle	675		678-679
				AD HN 40	SO 01020
Übergangsmuffe Adaptateur femelle - femelle Female adaptor	667-668	Adapter Messing CV Adaptateurs laiton CV Adaptors brass CV			680
				AD FA 40	SO 01200
Übergangsnippel Adaptateur femelle - mâle Adaptor female - male	668-670	Übergangsmuffe Adaptateur femelle - femelle Female adaptor	676		680
				AD A 40	SO 01500
Sechskantmuffe Manchon hexagonal Hexagonal threaded socket	670	Übergangsnippel Adaptateur femelle - mâle Adaptor female - male	676-677		681-682
				AD HC 40	SO 02000
Rohrkappe Capuchon Hexagonal cap	671	Verschlusschraube Bouchon fileté Screw plug	677		682
				AD HCP 40	SO 03000
Verschlusschraube Bouchon fileté Screw plug	671-674	Einschraubtülle Douille cannelée à visser Male adaptor hose nozzle	677		Sonderausführungen auf Anfrage Exécution en option sur demande Optional services on request
				AD HP 40	
					Spezialreinigung - entfettet Traitement spécial - dégraissé Special treatment - degreased
Aufschraub-Winkel Coude femelle Female threaded elbow	674				
				AD FE 40	Vorbeschichtete Gewinde PTFE-Band umwickelt Filetages pré enduits avec ruban en PTFE Pre-coated threads with PTFE-tape
					Vorbeschichtete Gewinde mit Loctite 5061 Filetages pré enduits avec Loctite 5061 Pre-coated threads with Loctite 5061
					Chemisch vernickelt Nickelage chimique Chemical nickel-plated

Seite/Page/Page		Seite/Page/Page		Seite/Page/Page	
	<p>Adapter Edelstahl Adaptateurs acier inoxydable Adaptors stainless steel</p>				
		<p>Muffe kurz Manchon court Threaded socket short</p>	<p>691</p>  <p>AD CS 50</p>	<p>697</p> <p>Aufschraub-T Té femelle Female threaded tee</p>  <p>AD FT 51</p>	
<p>Doppelnippel Mamelon double Male threaded adaptor</p>	<p>684-685</p>  <p>AD HN 50</p>	<p>Hochdruckanschweissmuffe Manchon à souder pour haute pression High-pressure weld-on socket</p>	<p>691</p>  <p>AD FCW 50 NPT</p>	<p>698-699</p> <p>Einschraubtülle Douille cannelée à visser Male adaptor hose nozzle</p>  <p>SO 50511</p>	
<p>Sechskantnippel Adaptateur hexagonal Hexagonal nipple</p>	<p>686</p>  <p>ADH A 50</p>	<p>Sechskantmuffe Manchon hexagonal Hexagonal threaded socket</p>	<p>691-692</p>  <p>AD HC 50</p>	<p>Sonderausführungen auf Anfrage Exécution en option sur demande Optional services on request</p> <p> Spezialreinigung - entfettet Traitement spécial - dégraissé Special treatment - degreased</p> <p> Vorbeschichtete Gewinde mit Loctite 5061 Filetages pré enduits avec Loctite 5061 Pre-coated threads with Loctite 5061</p>	
<p>Rohrdoppelnippel Mamelon double tubulaire Tube double threaded nipple</p>	<p>686</p>  <p>AD CN 50</p>	<p>Rohrkappe Capuchon Hexagonal cap</p>	<p>692</p>  <p>AD HCP 50</p>	<p>Bestätigungen auf www.serto.com Confirmations sur www.serto.com Confirmations on www.serto.com</p> <p></p>	
<p>Rohrnippel Mamelon tubulaire Tube nipple</p>	<p>687</p>  <p>AD CNS 50</p>	<p>Verschlusschraube Bouchon fileté Screw plug</p>	<p>692-695</p>  <p>AD HP 50</p>		
<p>Rohranschweissnippel Embout fileté à souder Weld-on nipple</p>	<p>687</p>  <p>AD CNW 50</p>	<p>Sechskant-Kontermutter Contre-écrou à six pans Hexagonal counter nut</p>	<p>696</p>  <p>AD HCN 50</p>	<p>700</p> <p>Einschraubtülle Douille cannelée à visser Male adaptor hose nozzle</p>  <p>SO 10511 OR</p>	
<p>Übergangsnippel Adaptateur femelle - mâle Adaptor female - male</p>	<p>688-690</p>  <p>AD A 50</p>	<p>Aufschraub-Winkel Coude femelle Female threaded elbow</p>	<p>696</p>  <p>AD FE 51</p>		
<p>Muffe lang Manchon long Threaded socket long</p>	<p>690</p>  <p>AD C 50</p>	<p>Einschraub-/Aufschraub-Winkel Coude mâle - femelle Male/female threaded elbow</p>	<p>697</p>  <p>AD SE 51</p>		

Seite/Page/Page

Seite/Page/Page

Seite/Page/Page

Adapter PVDF
Adaptateurs PVDF
Adaptors PVDF

Adapter PA
Adaptateurs PA
Adaptors PA

Diverses
Divers
Various

Übergangsmuffe
 Adaptateur femelle - femelle
 Female adaptor



702
SO 20031

Einschraubtülle
 Douille cannelée à visser
 Male adaptor hose nozzle



705
SO 30511

Rohrkompenzierverbindung
 Compensateur de tube
 Tube compensator



708
RK 51900

Übergangsnippel
 Adaptateur femelle - mâle
 Adaptor female - male



702-703
SO 20041

Sonderausführungen auf Anfrage
Exécution en option sur demande
Optional services on request



Vorbeschichtete Gewinde mit Loctite 5061
 Filetages pré enduits avec Loctite 5061
 Pre-coated threads with Loctite 5061

Verschlusschraube
 Bouchon fileté
 Screw plug



703
SO 20371

Einschraubtülle
 Douille cannelée à visser
 Male adaptor hose nozzle



703
SO 20511

Doppelnippel
 Mamelon double
 Male threaded adaptor



704
SO 21109

Bestätigungen auf www.serto.com
Confirmations sur www.serto.com
Confirmations on www.serto.com



Adapter Messing

Eigenschaften, Besonderheiten

- einfache Verbindungselemente mit Innen- und Aussengewinden, Tüllen und Abschlusselementen
- zahlreiche Bauformen
- viele Kombinationsmöglichkeiten

Betriebsdruck

niedrige bis mittlere Drücke

Werkstoff

Messing CW 617N (CuZn40Pb2), Oberfläche gebeizt.
Detailangaben chemische Vernickelung siehe Kapitel 2.

Herstellung

Messing M und CV:

- gerade Verbinder: gefertigt aus Vollmaterial
- Typen AD FE/FT: Druckguss

Messing G:

gefertigt aus Vollmaterial

Gewinde

G = Rohrgewinde BSP (zylindrisch) ISO 228
R = Rohrgewinde (kegelig) EN 10226-1
NPT = Rohrgewinde (kegelig) ANSI B 1.20.1

Adaptateurs laiton

Propriétés, spécificités

- éléments simples d'assemblage avec des filetages intérieurs et extérieurs, des douilles et des éléments de fermeture
- grand nombre de formes de construction
- nombreuses possibilités de combinaison

Pression de service

pression faible à moyenne

Matériaux

Laiton CW 617N (CuZn40Pb2), la surface est décapée.
Détails du nickelage chimique voir chapitre 2.

Fabrication

Laiton M et CV:

- connecteurs droits: fabriqués de matériel plein
- types AD FE/FT: moulage sous pression

Laiton G:

fabriqués de matériel plein

Filetages

G = filetage gas BSP (cylindrique) ISO 228
R = filetage gas BSP (conique) EN 10226-1
NPT = filetage NPT (conique) ANSI B 1.20.1

Adaptors brass

Characteristics, specialities

- simple connecting pieces with internal and external threads, hose nozzles and end elements
- large number of design types
- many possible combinations

Working pressure

low to medium pressure

Material

Brass CW 617N (CuZn40Pb2), the surface is pickled.
Details for nickel-plated brass see chapter 2.

Manufacture

Brass M and CV:

- straight connectors: made of solid material
- types AD FE/FT: die casting

Brass G:

made of solid material

Threads

G = BSP pipe thread (parallel) ISO 228
R = BSP pipe thread (tapered) EN 10226-1
NPT = NPT pipe thread (tapered) ANSI B 1.20.1

Doppelnippel R-R

Mamelon double R-R

Male threaded adaptor R-R

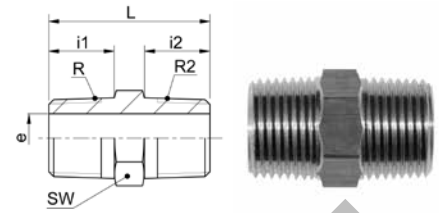

AD HN 40 R

Type -R-R2	Mat.-Nr.	SW	L	i1	i2	e	kg/100
R=Rohrgewinde (kegelig)		R=Filetage-gaz BSP (conique)				R=BSP thread (tapered)	
R2=Rohrgewinde (kegelig)		R2=Filetage-gaz BSP (conique)				R2=BSP thread (tapered)	
AD HN 40-1/8 -1/8	TAD.4110.042	10	21.0	8.0	8.0	6.0	0.760
AD HN 40-1/8 -1/4	TAD.4110.044	14	26.0	8.0	12.0	6.0	1.200
AD HN 40-1/4 -1/4	TAD.4110.104	14	30.0	12.0	12.0	8.0	1.610
AD HN 40-1/4 -3/8	TAD.4110.106	17	31.0	12.0	12.0	8.0	2.010
AD HN 40-1/4 -1/2	TAD.4110.108	22	34.0	12.0	14.0	8.0	2.980
AD HN 40-3/8 -3/8	TAD.4110.166	17	30.0	12.0	12.0	10.5	3.240
AD HN 40-3/8 -1/2	TAD.4110.168	22	34.0	12.0	14.0	10.0	4.930
AD HN 40-1/2 -1/2	TAD.4110.228	22	36.0	14.0	14.0	14.0	5.420
AD HN 40-1/2 -3/4	TAD.4110.232	27	39.0	14.0	16.0	14.0	8.360
AD HN 40-1/2 -1	TAD.4110.236	36	43.0	14.0	18.0	14.0	15.240
AD HN 40-3/4 -3/4	TAD.4110.292	27	41.0	16.0	16.0	18.0	9.410
AD HN 40-1 -1	TAD.4110.414	36	51.0	18.0	18.0	24.0	17.760

Doppelnippel R-NPT

Mamelon double R-NPT

Male threaded adaptor R-NPT

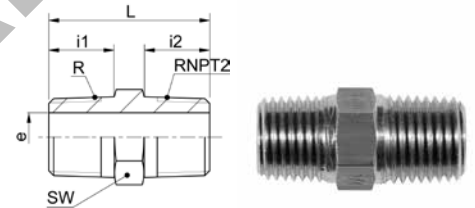

AD HN 40 R-NPT

Type -R-RNPT2	Mat.-Nr.	SW	L	i1	i2	e	kg/100
R=Rohrgewinde (kegelig)		R=Filetage-gaz BSP (conique)				R=BSP thread (tapered)	
RNPT2=NPT Gewinde		RNPT2=Filetage NPT				RNPT2=NPT thread	
AD HN 40-1/8-1/8 NPT	TAD.4114.042	12	24.5	10.0	10.0	6.0	1.240
AD HN 40-1/4-1/4 NPT	TAD.4114.104	14	32.0	12.0	14.0	8.0	1.700
AD HN 40-3/8-3/8 NPT	TAD.4114.166	17	34.0	14.0	14.0	10.5	4.370
AD HN 40-1/2-1/2 NPT	TAD.4114.228	22	45.0	19.0	19.0	13.0	8.260
AD HN 40-1-1 NPT	TAD.4114.414	36	60.0	25.0	25.0	23.0	23.550

Doppelnippel NPT-NPT

Mamelon double NPT-NPT

Male threaded adaptor NPT-NPT

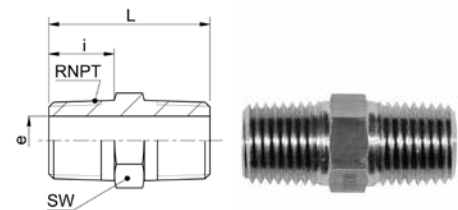

AD HN 40 NPT-NPT

Type -RNPT	Mat.-Nr.	SW	L	i	e	kg/100
RNPT=NPT Gewinde		RNPT=Filetage NPT				
AD HN 40-1/8 NPT-1/8 NPT	TAD.4111.042	12	24.5	10.0	6.0	1.150
AD HN 40-1/4 NPT-1/4 NPT	TAD.4111.104	14	34.0	14.0	8.0	2.720
AD HN 40-3/8 NPT-3/8 NPT	TAD.4111.166	17	34.0	14.0	10.5	3.950
AD HN 40-1/2 NPT-1/2 NPT	TAD.4111.228	22	45.0	19.0	13.0	8.240

Doppelnippel G

60°-Innenkonus

Mamelon double G

cône intérieur 60°

Male threaded adaptor G

60° inner cone

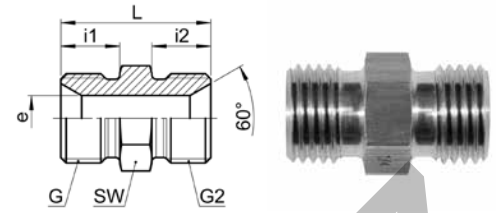

ADH HNC 40

Type -G -G2	Mat.-Nr.	SW	L	i1	i2	e	kg/100
G=Rohrgewinde (zylindrisch)							
G2=Rohrgewinde (zylindrisch)							
ADH HNC 40-1/4-1/4	496.4100.104	14	26.0	10.0	10.0	7.5	1.690
ADH HNC 40-1/4-3/8	496.4100.106	14	27.0	10.0	11.0	7.5	2.330
ADH HNC 40-3/8-3/8	496.4100.166	17	28.0	11.0	11.0	8.5	3.160

Übergangsmuffe G-G

Adaptateur femelle G - femelle G

Female adaptor G-G

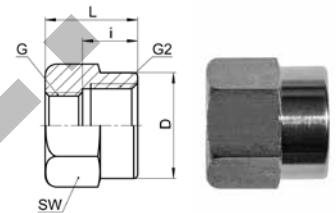

AD FA 40

Type -G -G2	Mat.-Nr.	SW	L	D	i	kg/100
G=Rohrgewinde (zylindrisch)						
G2=Rohrgewinde (zylindrisch)						
AD FA 40-1/8-1/8	016.0311.042	14	16.0	13.8	8.0	1.240
AD FA 40-1/8-1/4	016.0311.044	17	19.0	16.8	9.0	2.170
AD FA 40-1/8-3/8	016.0311.046	22	20.0	21.8	9.5	4.160
AD FA 40-1/8-1/2	016.0311.048	27	22.0	26.8	11.5	6.940
AD FA 40-1/4-1/4	016.0311.104	17	18.0	16.8	9.0	1.710
AD FA 40-1/4-3/8	016.0311.106	22	21.0	21.8	9.5	4.060
AD FA 40-1/4-1/2	016.0311.108	27	23.0	26.8	11.5	6.900
AD FA 40-3/8-3/8	016.0311.166	22	19.0	21.8	9.5	3.090
AD FA 40-3/8-1/2	016.0311.168	27	23.5	26.8	11.5	6.520
AD FA 40-1/2-1/2	016.0311.228	27	23.0	26.8	11.5	5.450
AD FA 40-3/4-3/8	016.0311.286	32	26.5	31.8	9.5	7.830
AD FA 40-3/4-1/2	016.0311.288	32	28.5	31.8	11.5	9.870
AD FA 40-3/4-3/4	016.0311.292	32	28.0	31.8	14.0	7.580

Übergangsmuffe G-NPT

Adaptateur femelle G - femelle NPT

Female adaptor G-NPT

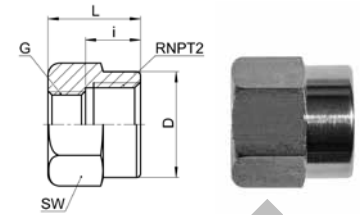

AD FA 40 NPT

Type -G -RNPT2	Mat.-Nr.	SW	L	D	i	kg/100
G=Rohrgewinde (zylindrisch)	G=Filetage-gaz BSP (cylindrique)			G=BSP thread (parallel)		
RNPT2=NPT Gewinde	RNPT2=Filetage NPT			RNPT2=NPT thread		
AD FA 40-1/8-1/8 NPT	016.0312.042	14	20.0	13.8	10.0	1.340
AD FA 40-1/8-1/4 NPT	016.0312.044	19	22.0	18.8	14.0	3.970
AD FA 40-1/8-3/8 NPT	016.0312.046	22	22.0	21.8	14.0	4.260
AD FA 40-1/4-1/8 NPT	016.0312.102	17	18.5	16.8	7.5	2.710
AD FA 40-1/4-1/4 NPT	016.0312.104	19	25.0	18.8	14.0	4.300
AD FA 40-1/4-3/8 NPT	016.0312.106	22	23.0	21.8	14.0	4.060
AD FA 40-3/8-1/4 NPT	016.0312.164	22	21.0	21.8	9.0	3.670
AD FA 40-3/8-3/8 NPT	016.0312.166	22	26.0	21.8	14.0	4.270
AD FA 40-3/8-1/2 NPT	016.0312.168	27	28.0	26.8	18.0	6.870
AD FA 40-1/2-1/4 NPT	016.0312.224	27	23.0	19.8	9.0	6.030
AD FA 40-1/2-3/8 NPT	016.0312.226	27	24.0	26.8	10.0	6.520
AD FA 40-1/2-1/2 NPT	016.0312.228	27	32.0	26.8	18.0	6.850

Übergangsnippel G-R

Adaptateur femelle G - mâle R

Adaptor female G - male R

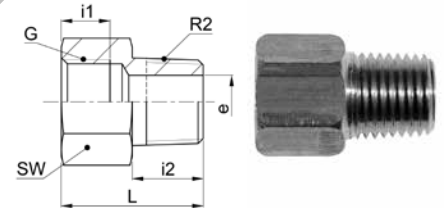

AD A 40 G-R

Type -G -R2	Mat.-Nr.	SW	L	i1	i2	e	kg/100
G=Rohrgewinde (zylindrisch)	G=Filetage-gaz BSP (cylindrique)			G=BSP thread (parallel)			
R2=Rohrgewinde (kegelig)	R2=Filetage-gaz BSP (conique)			R2=BSP thread (tapered)			
AD A 40-1/8-1/8	016.0411.042	14	21.0	8.0	8.0	5.0	2.100
AD A 40-1/8-1/4	016.0411.044	14	17.5	8.0	12.0	8.6	1.060
AD A 40-1/8-3/8	016.0411.046	17	18.0	8.0	12.0	8.6	2.280
AD A 40-1/8-1/2	016.0411.048	22	23.0	9.6	16.0	14.0	3.970
AD A 40-1/4-1/8	016.0411.102	17	21.0	9.0	8.0	5.0	1.630
AD A 40-1/4-1/4	016.0411.104	17	26.0	9.0	12.0	8.5	2.600
AD A 40-1/4-3/8	016.0411.106	17	20.0	9.0	12.0	11.4	1.690
AD A 40-1/4-1/2	016.0411.108	22	23.0	9.7	16.0	14.0	3.590
AD A 40-1/4-3/4	016.0411.110	27	25.5	11.2	16.5	19.0	9.050
AD A 40-3/8-1/8	016.0411.162	22	24.0	9.5	8.0	5.0	3.490
AD A 40-3/8-1/4	016.0411.164	22	27.0	9.5	12.0	8.5	3.180
AD A 40-3/8-3/8	016.0411.166	22	27.0	9.5	12.0	10.5	4.500
AD A 40-3/8-1/2	016.0411.168	22	26.0	9.5	16.0	15.0	2.740
AD A 40-3/8-3/4	016.0411.170	27	25.5	9.5	16.5	14.8	7.510
AD A 40-1/2-1/4	016.0411.224	27	29.0	11.5	12.0	8.5	5.852
AD A 40-1/2-3/8	016.0411.226	27	29.0	11.5	12.0	10.5	5.720
AD A 40-1/2-1/2	016.0411.228	27	32.0	11.5	14.0	13.0	8.200
AD A 40-1/2-3/4	016.0411.232	27	27.5	11.5	16.5	18.6	5.133
AD A 40-1/2-1	016.0411.236	36	31.0	12.5	18.5	24.0	13.100
AD A 40-3/4-3/8	016.0411.286	32	33.5	14.0	12.0	10.5	8.900
AD A 40-3/4-1/2	016.0411.288	32	37.5	14.0	16.0	14.0	11.000
AD A 40-3/4-3/4	016.0411.292	32	38.0	14.0	16.5	19.0	9.400
AD A 40-3/4-1	016.0411.296	36	34.0	14.0	20.0	24.1	13.900

Übergangsnippel G-NPT

Adaptateur femelle G - mâle NPT

Adaptor female G - male NPT

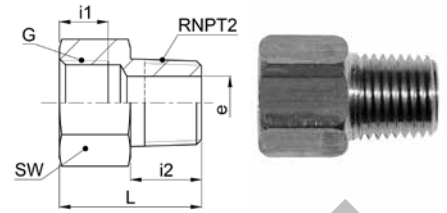

AD A 40 G-NPT

Type -G -RNPT2	Mat.-Nr.	SW	L	i1	i2	e	kg/100
G=Rohrgewinde (zylindrisch)	G=Filetage-gaz BSP (cylindrique)		G=BSP thread (parallel)				
RNPT2=NPT Gewinde	RNPT2=Filetage NPT		RNPT2=NPT thread				
AD A 40-1/8-1/8 NPT	016.0412.042	14	23.0	8.0	10.0	6.0	2.300
AD A 40-1/8-1/4 NPT	016.0412.044	14	20.0	8.0	14.0	8.6	1.200
AD A 40-1/4-1/8 NPT	016.0412.102	17	24.5	9.0	10.0	6.0	3.000
AD A 40-1/4-1/4 NPT	016.0412.104	17	26.5	9.0	14.0	8.5	3.900
AD A 40-1/4-3/8 NPT	016.0412.106	17	21.0	9.0	14.0	10.5	2.800
AD A 40-1/4-1/2 NPT	016.0412.108	22	27.0	9.0	19.0	11.4	7.700
AD A 40-3/8-1/4 NPT	016.0412.164	22	29.5	9.5	14.0	8.5	5.900
AD A 40-3/8-3/8 NPT	016.0412.166	22	29.5	9.5	14.0	10.5	6.800
AD A 40-3/8-1/2 NPT	016.0412.168	22	27.0	9.5	19.0	14.0	5.400
AD A 40-3/8-3/4 NPT	016.0412.170	27	29.0	9.5	20.0	15.0	12.800
AD A 40-1/2-1/4 NPT	016.0412.224	27	32.0	11.5	14.0	8.5	6.900
AD A 40-1/2-3/8 NPT	016.0412.226	27	32.0	11.5	14.0	10.5	7.100
AD A 40-1/2-1/2 NPT	016.0412.228	27	37.5	11.5	19.0	14.0	11.100
AD A 40-1/2-3/4 NPT	016.0412.232	27	31.0	11.5	20.0	18.6	8.900
AD A 40-3/4-3/4 NPT	016.0412.292	32	41.5	14.0	20.0	19.0	17.200
AD A 40-3/4-1 NPT	016.0412.296	36	33.0	14.0	25.0	24.1	16.500
AD A 40-1-1 NPT	016.0412.414	41	45.0	17.0	25.0	23.0	21.600

Übergangsnippel NPT-R

Adaptateur femelle NPT - mâle R

Adaptor female NPT - male R

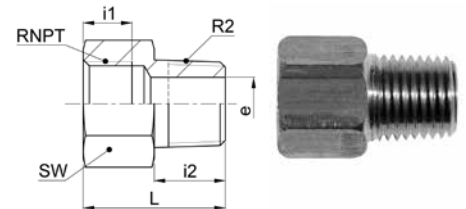

AD A 40 NPT-R

Type -RNPT -R2	Mat.-Nr.	SW	L	i1	i2	e	kg/100
RNPT=NPT Gewinde	RNPT=Filetage NPT		RNPT=NPT thread				
R2=Rohrgewinde (kegelig)	R2=Filetage-gaz BSP (conique)		R2=BSP thread (tapered)				
AD A 40-1/8 NPT-1/8	016.0414.042	14	21.0	10.0	8.0	6.0	1.470
AD A 40-1/8 NPT-1/4	016.0414.044	14	18.0	10.0	12.0	8.1	1.130
AD A 40-1/4 NPT-1/4	016.0414.104	17	29.0	14.0	12.0	8.5	2.740
AD A 40-1/4 NPT-3/8	016.0414.106	17	22.0	14.0	12.0	10.5	1.650
AD A 40-1/2 NPT-1/2	016.0414.228	27	38.0	18.0	16.0	14.0	8.310

Übergangsnippel NPT-NPT

Adaptateur femelle NPT - mâle NPT

Adaptor female NPT - male NPT

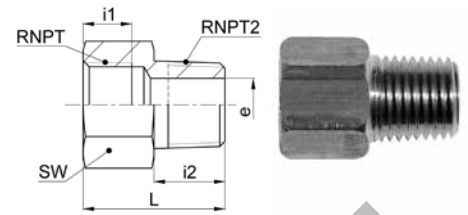

AD A 40 NPT-NPT

Type -RNPT -RNPT2	Mat.-Nr.	SW	L	i1	i2	e	kg/100
RNPT=NPT Gewinde RNPT2=NPT Gewinde		RNPT=Filetage NPT RNPT2=Filetage NPT				RNPT=NPT thread RNPT2=NPT thread	
AD A 40-1/4 NPT-1/8 NPT	016.0415.102	17	27.5	14.0	10.0	4.5	2.450
AD A 40-1/4 NPT-1/4 NPT	016.0415.104	17	31.5	14.0	14.0	8.5	2.600
AD A 40-1/4 NPT-1/2 NPT	016.0415.108	22	27.0	10.0	19.0	14.0	5.200
AD A 40-1/2 NPT-1/4 NPT	016.0415.224	27	37.0	13.5	14.0	8.5	8.600
AD A 40-1/2 NPT-3/8 NPT	016.0415.226	27	37.0	13.5	14.0	10.5	9.200

Sechskantmuffe

Manchon hexagonal

Hexagonal threaded socket

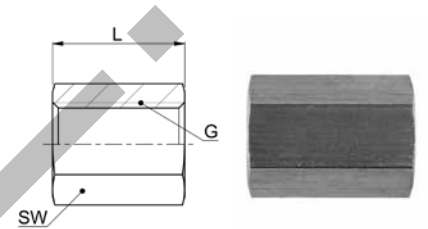

AD HC 40

Type -G	Mat.-Nr.	SW	L	kg/100
G=Rohrgewinde (zylindrisch)		G=Filetage-gaz BSP (cylindrique)		G=BSP thread (parallel)
AD HC 40-1/8	TAD.4100.042	14	22.0	1.240
AD HC 40-1/4	TAD.4100.104	17	26.0	1.710
AD HC 40-3/8	TAD.4100.166	22	26.0	3.090
AD HC 40-1/2	TAD.4100.228	27	30.0	7.800
AD HC 40-3/4	TAD.4100.292	32	36.0	11.170
AD HC 40-1	TAD.4100.414	41	36.0	21.400

Sechskantmuffe reduziert

Manchon hexagonal réduit

Hexagonal threaded socket reduced

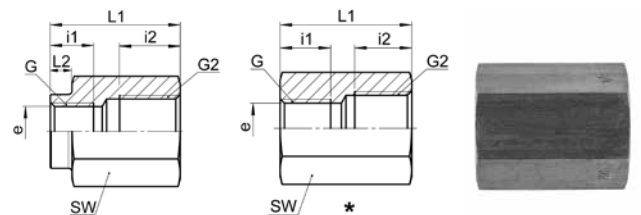

AD HRC 40

Type -G -G2	Mat.-Nr.	SW	L1	L2	i1	i2	e	kg/100
G=Rohrgewinde (zylindrisch) G2=Rohrgewinde (zylindrisch)		G=Filetage-gaz BSP (cylindrique) G2=Filetage-gaz BSP (cylindrique)					G=BSP thread (parallel) G2=BSP thread (parallel)	
AD HRC 40-1/8 -1/4 *	TAD.4100.044	22	25.0	0.0	8.0	12.0	8.5	7.060
AD HRC 40-1/8 -3/8	TAD.4100.046	22	20.0	4.0	8.0	10.5	8.5	4.160
AD HRC 40-1/4 -3/8 *	TAD.4100.106	22	30.0	0.0	12.0	12.0	11.4	7.050
AD HRC 40-1/4 -1/2	TAD.4100.108	27	24.0	7.0	10.0	11.5	11.4	6.900
AD HRC 40-1/4 -3/4	TAD.4100.110	32	26.0	5.0	9.0	14.0	11.4	7.580
AD HRC 40-3/8 -1/2 *	TAD.4100.168	27	34.0	0.0	12.0	14.0	14.9	11.550
AD HRC 40-1/2 -3/4 *	TAD.4100.232	32	28.5	0.0	11.5	14.0	18.6	10.700
AD HRC 40-1/2 -1 *	TAD.4100.236	41	31.5	0.0	11.5	17.0	18.6	21.400

Rohrkappe G

mit EPDM-Dichtung

Capuchon G

avec joint EPDM

Hexagonal cap G

with EPDM sealing

AD HCP 40

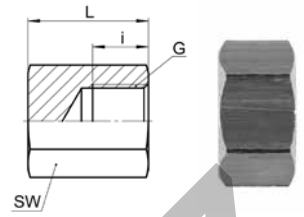

Type -G	Mat.-Nr.	SW	L	i	kg/100
G=Rohrgewinde (zylindrisch)		G=Filetage-gaz BSP (cylindrique)		G=BSP thread (parallel)	
AD HCP 40-1/8	TAD.4000.020	14	10.0	8.0	0.980
AD HCP 40-1/4	TAD.4000.040	17	10.0	8.0	1.170
AD HCP 40-3/8	TAD.4000.060	19	10.0	8.0	3.460
AD HCP 40-1/2	TAD.4000.080	23	12.0	10.0	6.490
AD HCP 40-3/4	TAD.4000.120	30	14.5	12.0	11.490
AD HCP 40-1	TAD.4000.160	36	14.5	12.0	23.760

Verschlusschraube R

mit Aussen-6kt.

Bouchon fileté R

à six pans

Screw plug R

with hex-nut

AD HP 40 R

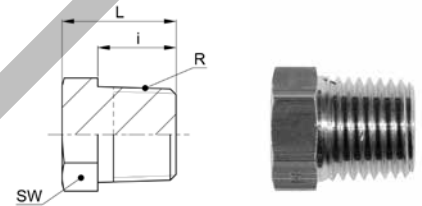

Type -R	Mat.-Nr.	SW	L	i	kg/100
R=Rohrgewinde (kegelig)		R=Filetage-gaz BSP (conique)		R=BSP thread (tapered)	
AD HP 40-1/8	TAD.4020.020	12	13.0	8.0	0.970
AD HP 40-1/4	TAD.4020.040	14	18.0	12.0	2.060
AD HP 40-3/8	TAD.4020.060	17	19.0	12.0	3.460
AD HP 40-1/2	TAD.4020.080	22	22.0	14.0	6.490
AD HP 40-3/4	TAD.4020.120	27	25.0	16.0	11.490
AD HP 40-1	TAD.4020.160	36	31.0	20.0	23.760

Verschlusschraube NPT

mit Aussen-6kt.

Bouchon fileté NPT

à six pans

Screw plug NPT

with hex-nut

AD HP 40 NPT

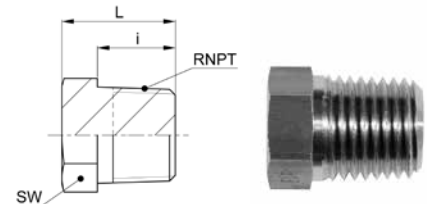

Type -RNPT	Mat.-Nr.	SW	L	i	kg/100
RNPT=NPT Gewinde		RNPT=Filetage NPT		RNPT=NPT thread	
AD HP 40-1/8 NPT	TAD.4021.020	12	15.0	10.0	1.130
AD HP 40-1/4 NPT	TAD.4021.040	14	20.0	14.0	2.320
AD HP 40-3/8 NPT	TAD.4021.060	17	22.0	14.0	4.400
AD HP 40-1/2 NPT	TAD.4021.080	22	27.0	19.0	7.720
AD HP 40-3/4 NPT	TAD.4021.120	27	29.0	20.0	13.600

Verschlusschraube R

mit Innen-6kt.

Bouchon fileté R

avec six pans creux

Screw plug R

locked with Allen key

AD SP 40

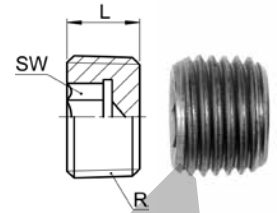

Type -R	Mat.-Nr.	SW	L	kg/100
R=Rohrgewinde (kegelig)	R=Filetage-gaz BSP (conique)		R=BSP thread (tapered)	
AD SP 40-1/8	016.0711.020	5	8.0	0.340
AD SP 40-1/4	016.0711.040	7	10.0	0.750
AD SP 40-3/8	016.0711.060	8	10.0	1.320
AD SP 40-1/2	016.0711.080	10	10.0	1.940
AD SP 40-3/4	016.0711.120	12	12.0	4.110

Verschlusschraube G

mit Aussen-6kt.

Bouchon fileté G

à six pans

Screw plug G

with hex-nut

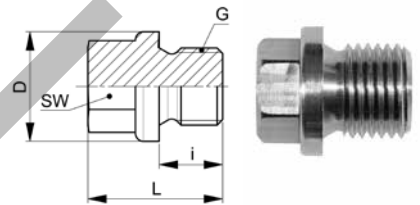

AD HPS 40

Type -G	Mat.-Nr.	SW	L	D	i	kg/100
G=Rohrgewinde (zylindrisch)	G=Filetage-gaz BSP (cylindrique)			G=BSP thread (parallel)		
AD HPS 40-1/8	TAD.4030.020	10	17.0	14.0	8.0	0.610
AD HPS 40-1/4	TAD.4030.040	13	21.0	18.0	12.0	1.430
AD HPS 40-3/8	TAD.4030.060	17	21.0	22.0	12.0	2.240
AD HPS 40-1/2	TAD.4030.080	19	26.0	26.0	14.0	4.250
AD HPS 40-3/4	TAD.4030.120	24	30.0	32.0	16.0	7.410

Einschraubgewinde nach DIN 3852-2 Form A.
Beim Einbau empfiehlt sich die Verwendung einer Dichtscheibe (z.B. SO 40007).
Die Dichtung muss bei Bedarf separat bestellt werden.

Filetage mâle selon DIN 3852-2 Forme A.
L'utilisation d'un joint (par exemple SO 40007) est recommandée pour l'installation.
Si nécessaire, le joint correspondant doit être commandé séparément.

Male adaptor thread according to DIN 3852-2 Form A.
The use of a sealing washer (e.g. SO 40007) is recommended for installation.
If required, the corresponding washer must be ordered separately.

Verschlusschraube G

mit Aussen-6kt. und Conovor O-Ringabdichtung (NBR)

Bouchon fileté G

à six pans, avec joint torique système Conovor (NBR)

Screw plug G

with hex-nut and Conovor O-ring seal (NBR)

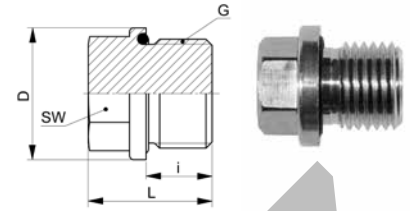

AD HPO 40

Type -G	Mat.-Nr.	SW	L	D	i	O-Ring	kg/100
G=Rohrgewinde (zylindrisch)		G=Filetage-gaz BSP (cylindrique)			G=BSP thread (parallel)		
AD HPO 40-1/8	TAD.4040.020	10	17.0	14.0	8.0	8.73x1.78	1.200
AD HPO 40-1/4	TAD.4040.040	13	21.0	18.0	12.0	11.1x1.78	2.460
AD HPO 40-3/8	TAD.4040.060	17	21.0	22.0	12.0	14.0x1.78	4.800
AD HPO 40-1/2	TAD.4040.080	19	26.0	26.0	14.0	18.72x2.62	7.180
AD HPO 40-3/4	TAD.4040.120	24	30.0	32.0	16.0	23.47x2.62	13.040

Verschlusschraube G

mit Innen-6kt.

Bouchon fileté G

avec six pans creux

Screw plug G

locked with Allen key

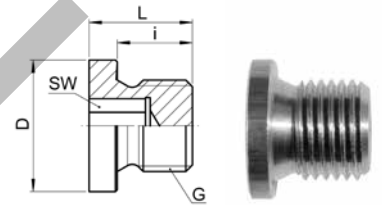

AD HSP 40

Type -G	Mat.-Nr.	SW	L	D	i	kg/100
G=Rohrgewinde (zylindrisch)		G=Filetage-gaz BSP (cylindrique)			G=BSP thread (parallel)	
AD HSP 40-1/8	TAD.4070.020	5	11.0	14.0	8.0	0.610
AD HSP 40-1/4	TAD.4070.040	6	15.0	18.0	12.0	1.430
AD HSP 40-3/8	TAD.4070.060	8	15.0	22.0	12.0	2.240
AD HSP 40-1/2	TAD.4070.080	10	18.0	26.0	14.0	4.250
AD HSP 40-3/4	TAD.4070.120	12	20.0	32.0	16.0	7.410
AD HSP 40-1	TAD.4070.160	17	21.0	39.0	16.0	11.000

Einschraubgewinde nach DIN 3852-2 Form A.
Beim Einbau empfiehlt sich die Verwendung einer Dichtscheibe (z.B. SO 40007).
Die Dichtung muss bei Bedarf separat bestellt werden.

Filetage mâle selon DIN 3852-2 Forme A.
L'utilisation d'un joint (par exemple SO 40007) est recommandée pour l'installation.
Si nécessaire, le joint correspondant doit être commandé séparément.

Male adaptor thread according to DIN 3852-2 Form A.
The use of a sealing washer (e.g. SO 40007) is recommended for installation.
If required, the corresponding washer must be ordered separately.

Verschlusschraube G

mit Innen-6kt. und Conovor O-Ringabdichtung (NBR)

Bouchon fileté G

avec six pans creux et joint torique système Conovor (NBR)

Screw plug G

locked with Allen key and Conovor O-ring seal (NBR)

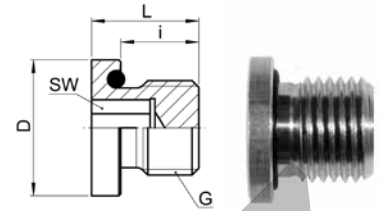

AD HSPO 40

Type -G	Mat.-Nr.	SW	L	D	i	O-Ring	kg/100
G=Rohrgewinde (zylindrisch)		G=Filetage-gaz BSP (cylindrique)			G=BSP thread (parallel)		
AD HSPO 40-1/8	TAD.4050.020	5	11.0	14.0	8.0	8.73x1.78	0.610
AD HSPO 40-1/4	TAD.4050.040	6	15.0	18.0	12.0	11.1x1.78	1.430
AD HSPO 40-3/8	TAD.4050.060	8	15.0	22.0	12.0	14.0x1.78	2.240
AD HSPO 40-1/2	TAD.4050.080	10	18.0	26.0	14.0	18.72x2.62	4.250
AD HSPO 40-3/4	TAD.4050.120	12	20.0	32.0	16.0	23.47x2.62	7.410

Aufschraub-Winkel G

Coude femelle G

Female threaded elbow G

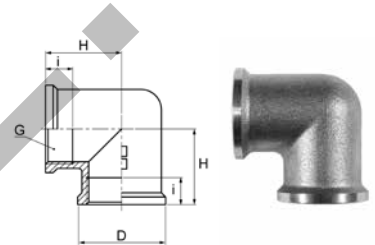

AD FE 40

Type -G	Mat.-Nr.	D	H	i	kg/100
G=Rohrgewinde (zylindrisch)		G=Filetage-gaz BSP (cylindrique)		G=BSP thread (parallel)	
AD FE 40-1/8-1/8	TAD.4300.042	15.0	15.0	8.0	2.000
AD FE 40-1/4-1/4	TAD.4300.104	20.0	19.0	10.0	4.380
AD FE 40-3/8-3/8	TAD.4300.166	23.0	23.0	11.0	5.930
AD FE 40-1/2-1/2	TAD.4300.228	30.0	25.0	12.0	7.430
AD FE 40-3/4-3/4	TAD.4300.292	36.0	30.0	15.0	12.090
AD FE 40-1-1	TAD.4300.414	42.0	35.0	16.0	21.100

Aufschraub-T G

Té femelle G

Female threaded tee G

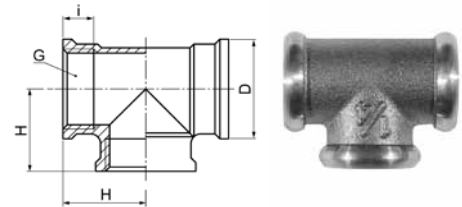

AD FT 40

Type -G	Mat.-Nr.	D	H	i	kg/100
G=Rohrgewinde (zylindrisch)		G=Filetage-gaz BSP (cylindrique)		G=BSP thread (parallel)	
AD FT 40-1/8-1/8-1/8	TAD.4400.060	15.0	14.0	8.0	2.610
AD FT 40-1/4-1/4-1/4	TAD.4400.160	21.0	17.5	10.0	5.680
AD FT 40-3/8-3/8-3/8	TAD.4400.350	23.0	21.5	11.0	9.360
AD FT 40-1/2-1/2-1/2	TAD.4400.450	30.0	24.0	12.0	9.700
AD FT 40-3/4-3/4-3/4	TAD.4400.520	36.0	30.0	15.0	16.760
AD FT 40-1-1-1	TAD.4400.650	42.0	34.0	16.0	25.850

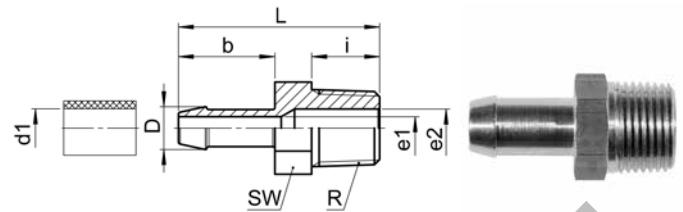
Einschraubtülle R
Douille cannelée à visser R
Male adaptor hose nozzle R

SO 40511

Type-d1-R	Mat.-Nr.	SW	L	D	i	b	e1	e2	kg/100
R=Rohrgewinde (kegelig)	R=Filetage-gaz BSP (conique)	R=BSP thread (tapered)							
SO 40511-4-1/8	016.0511.060	10	23.0	5.0	8.0	11.0	3.0	6.0	0.750
SO 40511-6-1/8	016.0511.100	10	29.0	7.5	8.0	17.0	4.0	6.0	0.730
SO 40511-6-1/4	016.0511.110	14	34.5	7.5	12.0	17.0	4.0	8.5	1.920
SO 40511-8-1/8	016.0511.160	10	29.0	9.5	8.0	17.0	6.0	6.0	0.780
SO 40511-8-1/4	016.0511.170	14	34.5	9.5	12.0	17.0	6.0	8.5	1.690
SO 40511-8-3/8	016.0511.180	17	35.0	9.5	12.0	17.0	6.0	10.5	2.580
SO 40511-8-1/2	016.0511.185	22	40.0	9.5	16.0	17.0	6.0	13.0	4.530
SO 40511-10-1/8	016.0511.265	12	31.0	11.5	8.0	19.0	8.0	6.0	1.150
SO 40511-10-1/4	016.0511.270	14	36.5	11.5	12.0	19.0	8.0	8.0	1.640
SO 40511-10-3/8	016.0511.280	17	37.0	11.5	12.0	19.0	8.0	10.5	2.710
SO 40511-10-1/2	016.0511.285	22	42.0	11.5	16.0	19.0	8.0	13.0	4.900
SO 40511-13-3/8	016.0511.450	17	39.0	15.0	12.0	21.0	11.0	11.0	2.910
SO 40511-13-1/2	016.0511.454	22	44.0	15.0	16.0	21.0	11.0	13.0	5.340
SO 40511-16-1/2	016.0511.566	22	49.0	18.0	16.0	26.0	13.0	13.0	5.410
SO 40511-19-1/2	016.0511.676	22	49.0	21.5	16.0	26.0	16.0	13.0	5.800
SO 40511-19-3/4	016.0511.678	27	51.0	21.5	16.5	26.0	16.0	19.0	8.280

d1 = Schlauchinnendurchmesser

d1 = diamètre intérieur du tuyau

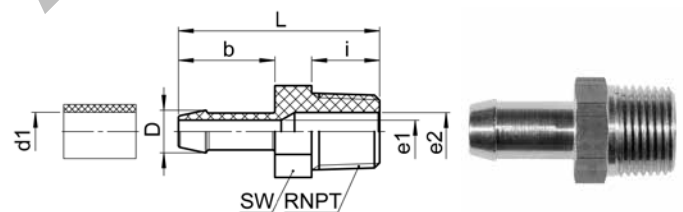
d1 = hose inside diameter

Einschraubtülle NPT
Douille cannelée à visser NPT
Male adaptor hose nozzle NPT

SO 40511 NPT

Type-d1-RNPT	Mat.-Nr.	SW	L	D	i	b	e1	e2	kg/100
RNPT=NPT Gewinde	RNPT=Filetage NPT	RNPT=NPT thread							
SO 40511-6-1/4 NPT	016.0512.110	14	36.5	7.5	14.0	17.0	4.0	8.5	1.900
SO 40511-6-3/8 NPT	016.0512.120	17	37.0	7.5	14.0	17.0	4.0	10.5	2.870
SO 40511-8-1/8 NPT	016.0512.160	12	31.5	9.5	10.0	17.0	6.0	6.0	1.190

d1 = Schlauchinnendurchmesser

d1 = diamètre intérieur du tuyau

d1 = hose inside diameter

Übergangsmuffe G-G

Adaptateur femelle G - femelle G

Female adaptor G-G

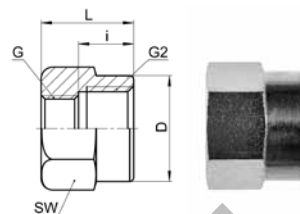

AD FA 80

Type -G -G2	Mat.-Nr.	SW	L	D	i	kg/100
G=Rohrgewinde (zylindrisch)	G=Filetage-gaz BSP (cylindrique)			G=BSP thread (parallel)		
G2=Rohrgewinde (zylindrisch)	G2=Filetage-gaz BSP (cylindrique)			G2=BSP thread (parallel)		
AD FA 80-1/8-1/8	036.0311.042	14	16.0	13.8	8.0	1.240
AD FA 80-1/8-1/4	036.0311.044	17	19.0	16.8	9.0	2.170
AD FA 80-1/4-1/4	036.0311.104	17	18.0	16.8	9.0	1.710
AD FA 80-1/4-3/8	036.0311.106	22	21.0	21.8	9.5	4.060
AD FA 80-1/4-1/2	036.0311.108	27	23.0	26.8	11.5	6.900
AD FA 80-3/8-3/8	036.0311.166	22	19.0	21.8	9.5	3.090
AD FA 80-3/8-1/2	036.0311.168	27	23.5	26.8	11.5	6.520
AD FA 80-1/2-1/2	036.0311.228	27	23.0	26.8	11.5	5.450
AD FA 80-3/4-1/2	036.0311.288	32	28.5	31.8	11.5	9.870

Übergangsnippel G-R

Adaptateur femelle G - mâle R

Adaptor female G - male R

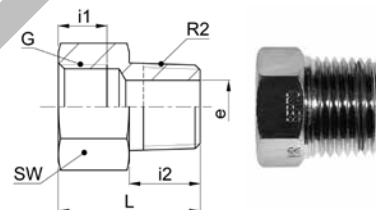

AD A 80 G-R

Type -G -R2	Mat.-Nr.	SW	L	i1	i2	e	kg/100
G=Rohrgewinde (zylindrisch)	G=Filetage-gaz BSP (cylindrique)			G=BSP thread (parallel)			
R2=Rohrgewinde (kegelig)	R2=Filetage-gaz BSP (conique)			R2=BSP thread (tapered)			
AD A 80-1/8-1/8	036.0411.042	14	21.0	8.0	8.0	5.0	2.100
AD A 80-1/8-1/4	036.0411.044	14	17.5	8.0	12.0	8.5	1.060
AD A 80-1/8-1/2	036.0411.048	22	23.0	9.6	16.0	14.0	3.970
AD A 80-1/4-1/8	036.0411.102	17	22.0	9.0	8.0	5.0	1.630
AD A 80-1/4-3/8	036.0411.106	17	20.0	9.0	12.0	11.4	1.690
AD A 80-1/4-1/2	036.0411.108	22	23.0	9.7	16.0	14.0	3.590
AD A 80-3/8-1/2	036.0411.168	22	23.0	9.5	16.0	14.9	2.740
AD A 80-1/2-3/4	036.0411.232	27	27.5	11.5	16.5	18.6	5.133

Übergangsnippel NPT-R

Adaptateur femelle NPT - mâle R

Adaptor female NPT - male R

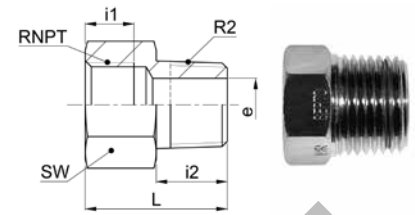

AD A 80 NPT-R

Type -RNPT -R2	Mat.-Nr.	SW	L	i1	i2	e	kg/100
RNPT=NPT Gewinde R2=Rohrgewinde (kegelig)	RNPT=Filetage NPT R2=Filetage-gaz BSP (conique)						
AD A 80-1/8 NPT-1/8	036.0414.042	14	21.0	10.0	8.0	6.0	1.470
AD A 80-1/8 NPT-1/4	036.0414.044	14	18.0	10.0	12.0	8.1	1.130
AD A 80-1/4 NPT-1/4	036.0414.104	17	29.0	14.0	12.0	8.5	2.740
AD A 80-1/4 NPT-3/8	036.0414.106	17	22.0	14.0	12.0	10.5	1.650
AD A 80-1/2 NPT-1/2	036.0414.228	27	38.0	18.0	16.0	14.0	8.310

Verschlusschraube R

mit Innen-6kt.

Bouchon fileté R

avec six pans creux

Screw plug R

locked with Allen key

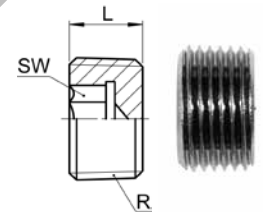

AD SP 80

Type -R	Mat.-Nr.	SW	L	kg/100
R=Rohrgewinde (kegelig)	R=Filetage-gaz BSP (conique)			
AD SP 80-1/8	036.0711.020	5	8.0	0.340
AD SP 80-1/4	036.0711.040	7	10.0	0.750
AD SP 80-3/8	036.0711.060	8	10.0	1.320
AD SP 80-1/2	036.0711.080	10	10.0	1.940

Einschraubtülle R

Douille cannelée à visser R

Male adaptor hose nozzle R

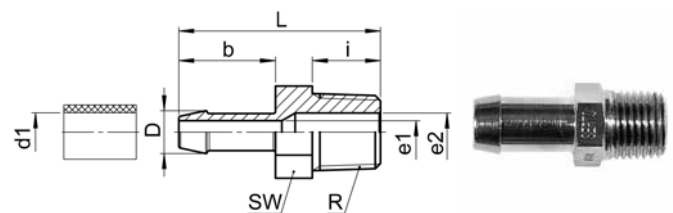

SO 80511

Type -d1 -R	Mat.-Nr.	SW	L	D	i	b	e1	e2	kg/100
R=Rohrgewinde (kegelig)	R=Filetage-gaz BSP (conique)								
SO 80511-6-1/8	036.0511.100	10	29.0	7.5	8.0	17.0	4.0	6.0	0.730
SO 80511-6-1/4	036.0511.110	14	34.5	7.5	12.0	17.0	4.0	8.5	1.920
SO 80511-8-1/4	036.0511.170	14	34.5	9.5	12.0	17.0	6.0	8.5	1.690
SO 80511-10-1/4	036.0511.270	14	36.5	11.5	12.0	19.0	8.0	8.0	1.640
SO 80511-13-3/8	036.0511.450	17	39.0	15.0	12.0	21.0	11.0	11.0	2.710

d1 = Schlauchinnendurchmesser

d1 = diamètre intérieur du tuyau

d1 = hose inside diameter

Doppelnippel G-G
Mamelon double G-G
Male threaded adaptor G-G

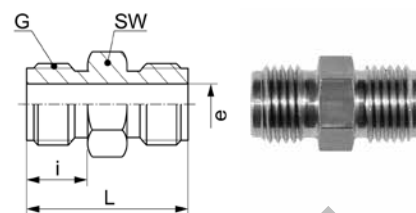

SO 01020

Type -G	Mat.-Nr.	bar	SW	L	i	e	kg/100
G=Rohrgewinde (zylindrisch)	G=Filetage-gaz BSP (cylindrique)				G=BSP thread (parallel)		
SO 01020-1/8-1/8	246.1020.060	125	12	26.0	10.0	4.5	1.420
SO 01020-1/4-1/4	246.1020.080	125	14	28.0	11.0	6.5	2.150
SO 01020-3/8-3/8	246.1020.100	100	17	30.0	11.5	8.5	3.800
SO 01020-1/2-1/2	246.1020.140	64	22	36.0	14.0	12.0	6.450

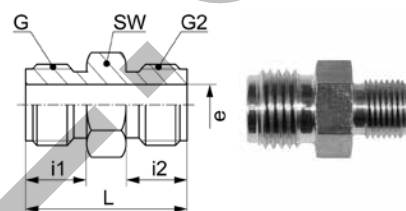
Doppelnippel G-G reduziert
Mamelon double G-G réduit
Reducing male threaded adaptor G-G

SO 01020 RED

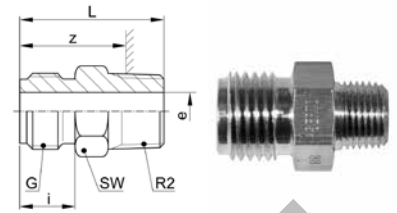
Type -G -G2	Mat.-Nr.	bar	SW	L	i1	i2	e	kg/100
G=Rohrgewinde (zylindrisch)	G=Filetage-gaz BSP (cylindrique)				G=BSP thread (parallel)			
G2=Rohrgewinde (zylindrisch)	G2=Filetage-gaz BSP (cylindrique)				G2=BSP thread (parallel)			
SO 01020-1/4-1/8	246.1024.140	125	14	27.0	11.0	10.0	4.5	2.100
SO 01020-3/8-1/4	246.1024.190	100	17	29.5	11.5	11.0	6.5	3.450
SO 01020-1/2-3/8	246.1024.240	64	22	33.5	14.0	11.5	8.5	6.200

Doppelnippel G-R
Mamelon double G-R
Male threaded adaptor G-R

SO 01100

Type -G-R2	Mat.-Nr.	bar	SW	L	i	z	e	kg/100
G=Rohrgewinde (zylindrisch)	G=Filetage-gaz BSP (cylindrique)		G=BSP thread (parallel)					
R2=Rohrgewinde (kegelig)	R2=Filetage-gaz BSP (conique)		R2=BSP thread (tapered)					
SO 01100-1/8 z-1/8 k	246.1101.100	125	10	22.0	10.0	18.0	4.0	1.310
SO 01100-1/8 z-1/4 k	246.1101.110	125	14	28.0	10.0	22.0	4.0	2.010
SO 01100-1/8 z-3/8 k	246.1101.120	125	17	28.0	10.0	21.6	4.0	2.810
SO 01100-1/4 z-1/8 k	246.1101.160	125	14	25.0	11.0	21.0	5.0	2.010
SO 01100-1/4 z-1/4 k	246.1101.170	125	14	29.0	11.0	23.0	6.5	2.410
SO 01100-1/4 z-3/8 k	246.1101.180	125	17	29.0	11.0	22.6	6.5	3.210
SO 01100-1/4 z-1/2 k	246.1101.185	125	22	34.0	11.0	25.8	6.5	4.910
SO 01100-3/8 z-1/4 k	246.1101.270	100	17	29.5	11.5	23.5	8.5	2.970
SO 01100-3/8 z-3/8 k	246.1101.280	100	17	29.5	11.5	23.1	8.5	3.570
SO 01100-3/8 z-1/2 k	246.1101.285	100	22	34.5	11.5	26.3	8.5	5.270
SO 01100-1/2 z-1/4 k	246.1101.380	64	22	33.0	14.0	27.0	8.0	5.970
SO 01100-1/2 z-3/8 k	246.1101.390	64	22	33.0	14.0	26.6	10.0	5.770
SO 01100-1/2 z-1/2 k	246.1101.504	64	22	37.0	14.0	28.8	12.0	6.260
SO 01100-1/2 z-3/4 k	246.1101.506	64	27	39.0	14.0	29.5	12.0	8.860
SO 01100-3/4 z-1/2 k	246.1101.596	64	27	40.0	15.0	31.8	14.0	9.190
SO 01100-3/4 z-3/4 k	246.1101.598	64	27	40.0	15.0	30.5	15.0	10.190

Doppelnippel G-G

mit Dichtkante

Mamelon double G-G

avec arête d'étanchéité

Male threaded adaptor G-G

with edge seal

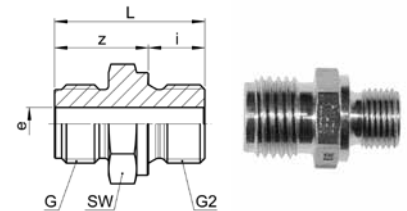

SO 01104

Type -G-G2	Mat.-Nr.	bar	SW	L	i	z	e	kg/100
G=Rohrgewinde (zylindrisch)	G=Filetage-gaz BSP (cylindrique)		G=BSP thread (parallel)					
G2=Rohrgewinde (zylindrisch)	G2=Filetage-gaz BSP (cylindrique)		G2=BSP thread (parallel)					
SO 01104-1/8-1/8	246.1141.100	125	14	23.5	8.0	15.5	4.0	1.410
SO 01104-1/8-1/4	246.1141.110	125	19	29.0	12.0	17.0	4.0	3.010
SO 01104-1/4-1/8	246.1141.160	125	14	24.5	8.0	16.5	5.0	1.710
SO 01104-1/4-1/4	246.1141.170	125	19	30.0	12.0	18.0	6.0	3.110
SO 01104-1/4-3/8	246.1141.180	125	22	31.5	12.0	19.5	6.0	4.010
SO 01104-3/8-1/4	246.1141.270	100	19	30.5	12.0	18.5	7.0	3.570
SO 01104-3/8-3/8	246.1141.280	100	22	32.0	12.0	20.0	7.0	5.470
SO 01104-1/2-1/4	246.1141.380	64	22	34.5	12.0	22.5	7.0	6.600
SO 01104-1/2-3/8	246.1141.390	64	22	34.5	12.0	22.5	9.0	6.270
SO 01104-1/2-1/2	246.1141.504	64	27	38.0	14.0	24.0	12.0	9.490

Übergangsnippel G-G

Adaptateur mâle G - femelle G

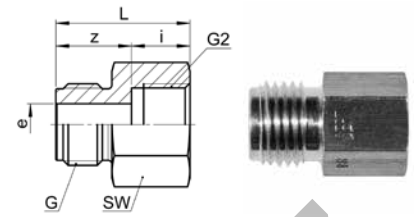
Adaptor male G - female G

SO 01200

Type -G -G2	Mat.-Nr.	bar	SW	L	i	z	e	kg/100
G=Rohrgewinde (zylindrisch)								
G2=Rohrgewinde (zylindrisch)								
G=Filetage-gaz BSP (cylindrique)								
G2=Filetage-gaz BSP (cylindrique)								
G=BSP thread (parallel)								
G2=BSP thread (parallel)								
SO 01200-1/8α-1/8i	246.1201.100	125	14	23.0	10.0	13.0	4.5	1.610
SO 01200-1/8α-1/4i	246.1201.110	125	17	25.0	11.0	14.0	4.5	2.310
SO 01200-1/8α-3/8i	246.1201.120	125	22	26.0	12.0	14.0	4.5	4.010
SO 01200-1/4α-1/8i	246.1201.160	125	14	24.0	10.0	14.0	6.5	2.010
SO 01200-1/4α-1/4i	246.1201.170	125	17	26.0	11.0	15.0	6.5	2.610
SO 01200-1/4α-3/8i	246.1201.180	125	22	27.0	12.0	15.0	6.5	4.010
SO 01200-1/4α-1/2i	246.1201.185	125	27	29.0	14.0	15.0	6.5	6.710
SO 01200-3/8α-1/4i	246.1201.270	100	17	26.5	11.0	15.5	8.5	2.970
SO 01200-3/8α-3/8i	246.1201.280	100	22	27.5	12.0	15.5	8.5	4.370
SO 01200-3/8α-1/2i	246.1201.285	100	27	30.0	14.0	16.0	8.5	6.970
SO 01200-3/8α-3/4i	246.1201.290	100	32	33.0	17.0	16.0	8.5	9.970
SO 01200-1/2α-3/8i	246.1201.390	64	22	30.0	12.0	18.0	10.5	5.370
SO 01200-1/2α-1/2i	246.1201.504	64	27	32.5	14.0	18.5	12.5	7.860
SO 01200-1/2α-3/4i	246.1201.506	64	32	35.5	17.0	18.5	12.5	11.060
SO 01200-3/4α-1/2i	246.1201.596	64	27	35.5	14.0	19.5	14.5	11.060
SO 01200-3/4α-3/4i	246.1201.598	64	32	36.5	17.0	19.5	15.5	11.060

Schott-Doppelnippel

Mamelon double traversée de cloison

Panel mount male threaded adaptor

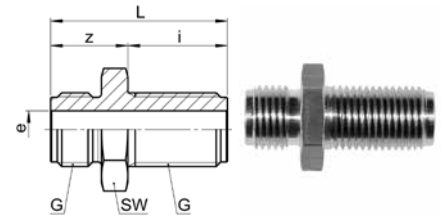
SO 01500

Type -G	Mat.-Nr.	bar	SW	L	i	z	e	kg/100
G=Rohrgewinde (zylindrisch)								
G=Filetage-gaz BSP (cylindrique)								
G=BSP thread (parallel)								
SO 01500-1/8-1/8	246.1500.060	125	14	35.0	20.0	15.0	4.0	1.900
SO 01500-1/4-1/4	246.1500.080	125	19	38.0	22.0	16.0	6.5	3.400
SO 01500-3/8-3/8	246.1500.100	100	24	40.0	22.5	17.5	8.5	6.100
SO 01500-1/2-1/2	246.1500.120	100	30	47.0	26.0	21.0	12.0	11.900

Schott-Doppelnippel lang

Mamelon double traversée de cloison long

Panel mount male threaded adaptor long

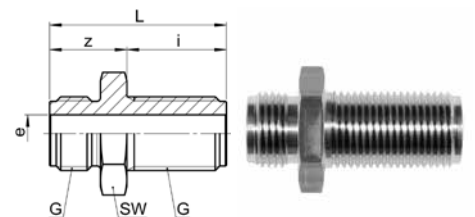
SO 01504

Type -G	Mat.-Nr.	bar	SW	L	i	z	e	kg/100
G=Rohrgewinde (zylindrisch)								
G=Filetage-gaz BSP (cylindrique)								
G=BSP thread (parallel)								
SO 01504-1/2-1/2	246.1540.140	100	30	58.0	37.0	21.0	12.0	11.800

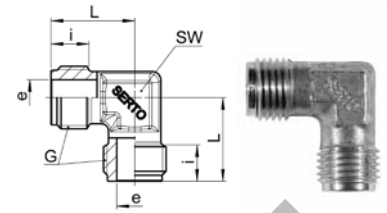
**Winkel G
Coude G
Elbow G**

SO 02000

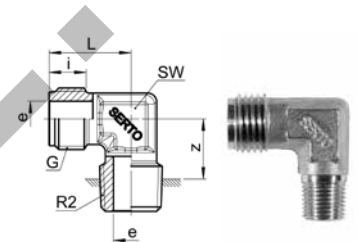
Type-G	Mat.-Nr.	bar	SW	L	i	e	kg/100
G=Rohrgewinde (zylindrisch)	G=Filetage-gaz BSP (cylindrique)		G=BSP thread (parallel)				
SO 02000-1/8-1/8	246.2000.060	125	10	19.0	8.5	4.0	1.620
SO 02000-1/4-1/4	246.2000.080	125	11	21.0	8.5	6.0	2.520
SO 02000-3/8-3/8	246.2000.100	100	14	22.0	9.5	8.5	3.740
SO 02000-1/2-1/2 (8+10+12)	246.2000.120	64	17	26.5	9.5	10.0	6.730
SO 02000-1/2-1/2 (14+15)	246.2000.140	64	19	28.0	12.5	12.0	6.640
SO 02000-3/4-3/4	246.2000.170	64	22	30.0	12.5	15.0	11.580

**Winkel G-R
Coude G-R
Elbow G-R**

SO 02400

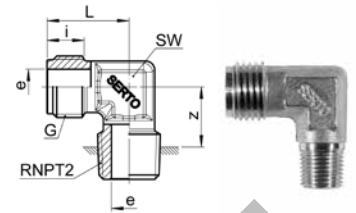
Type-G-R2	Mat.-Nr.	bar	SW	L	i	z	e	kg/100
G=Rohrgewinde (zylindrisch)	G=Filetage-gaz BSP (cylindrique)		G=BSP thread (parallel)					
R2=Rohrgewinde (kegelig)	R2=Filetage-gaz BSP (conique)		R2=BSP thread (tapered)					
SO 02400-1/8 z-1/8 k	246.2401.100	125	10	19.0	8.5	13.5	4.0	1.700
SO 02400-1/8 z-1/4 k	246.2401.110	125	11	21.0	8.5	15.0	4.0	2.600
SO 02400-1/4 z-1/8 k	246.2401.160	125	11	21.0	8.5	13.5	5.0	2.300
SO 02400-1/4 z-1/4 k	246.2401.170	125	11	21.0	8.5	15.0	6.0	2.800
SO 02400-1/4 z-3/8 k	246.2401.180	125	14	22.0	8.5	16.0	6.0	4.200
SO 02400-3/8 z-1/4 k	246.2401.270	100	14	22.0	9.5	15.0	8.5	3.700
SO 02400-3/8 z-3/8 k	246.2401.280	100	14	22.0	9.5	16.0	8.5	4.300
SO 02400-3/8 z-1/2 k	246.2401.285	100	19	28.0	10.0	19.0	8.0	6.700
SO 02400-1/2 z-1/4 k	246.2401.380	64	17	25.0	11.5	16.0	7.0	5.900
SO 02400-1/2 z-3/8 k	246.2401.390	64	17	25.0	11.5	16.0	10.0	5.900
SO 02400-1/2 z-1/2 k	246.2401.504	64	19	28.0	13.0	19.0	12.0	7.900
SO 02400-1/2 z-3/4 k	246.2401.506	64	22	30.0	13.0	20.0	12.0	8.300
SO 02400-3/4 z-1/2 k	246.2401.596	64	22	30.0	12.0	19.0	14.0	10.600
SO 02400-3/4 z-3/4 k	246.2401.598	64	22	30.0	12.0	20.0	15.0	12.700

Winkel G-NPT
Coude G-NPT
Elbow G-NPT



SO 02400 NPT

Type -G -RNPT2	Mat.-Nr.	bar	SW	L	i	z	e	kg/100
G=Rohrgewinde (zylindrisch)	G=Filetage-gaz BSP (cylindrique)		G=BSP thread (parallel)					
RNPT2=NPT Gewinde	RNPT2=Filetage NPT		RNPT2=NPT thread					
SO 02400-1/8 z-3/8 NPT	246.2402.120	125	14	21.0	8.5	16.0	4.0	3.900
SO 02400-1/4 z-3/8 NPT	246.2402.180	125	14	22.0	9.5	16.0	6.0	4.200

T-Stück G
Pièce Té G
T-piece G

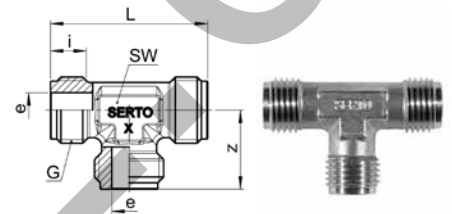

SO 03000

Type -G	Mat.-Nr.	bar	SW	L	i	z	e	kg/100
G=Rohrgewinde (zylindrisch)	G=Filetage-gaz BSP (cylindrique)		G=BSP thread (parallel)					
SO 03000-1/8-1/8-1/8	246.3000.060	125	10	38.0	8.5	19.0	4.0	2.200
SO 03000-1/4-1/4-1/4	246.3000.080	125	11	42.0	9.0	21.0	6.0	3.600
SO 03000-3/8-3/8-3/8	246.3000.100	100	14	44.0	9.5	22.0	8.0	5.200
SO 03000-1/2-1/2-1/2	246.3000.120	100	19	50.0	11.0	25.0	11.0	9.300
SO 03000-3/4-3/4-3/4	246.3000.170	64	27	64.0	13.0	32.0	15.0	15.700

Adapter Edelstahl

Adaptateurs inox

Adaptors stainless steel

Eigenschaften, Besonderheiten

- einfache Verbindungselemente mit Innen- und Aussengewinden, Tüllen und Abschlusselementen
- zahlreiche Bauformen
- viele Kombinationsmöglichkeiten

Betriebsdruck

niedrige bis mittlere Drücke

Werkstoff

- Typ 50 = 1.4571 (~ AISI 316 Ti)
- Typ 51 = 1.4401 (AISI 316)

Herstellung

- gerade Verbinder: gefertigt aus Vollmaterial
- Winkel und T-Stücke: Druckguss

Gewinde

G = Rohrgewinde BSP (zylindrisch) ISO 228
 R = Rohrgewinde (kegelig) EN 10226-1
 NPT = Rohrgewinde (kegelig) ANSI B 1.20.1

Bestätigungen

FDA für FKM-O-Ringe

Propriétés, spécificités

- éléments simples d'assemblage avec des filetages intérieurs et extérieurs, des douilles et des éléments de fermeture
- grand nombre de formes de construction
- nombreuses possibilités de combinaison

Pression de service

pression faible à moyenne

Matériaux

- type 50 = 1.4571 (~ AISI 316 Ti)
- type 51 = 1.4401 (AISI 316)

Fabrication

- connecteurs droits: fabriqués de matériel plein
- coudes et Tés: moulage sous pression

Filetages

G = filetage gas BSP (cylindrique) ISO 228
 R = filetage gas BSP (conique) EN 10226-1
 NPT = filetage NPT (conique) ANSI B 1.20.1

Confirmations

FDA pour les joints toriques FKM

Characteristics, specialities

- simple connecting pieces with internal and external threads, hose nozzles and end elements
- large number of design types
- many possible combinations

Working pressure

low to medium pressure

Materials

- type 50 = 1.4571 (~ AISI 316 Ti)
- type 51 = 1.4401 (AISI 316)

Manufacture

- straight connectors: made of solid material
- elbows and Tees: die casting

Threads

G = BSP pipe thread (straight) ISO 228
 R = BSP pipe thread (tapered) EN 10226-1
 NPT = NPT pipe thread (tapered) ANSI B 1.20.1

Confirmations

FDA for FKM O-rings

Doppelnippel R-R

Mamelon double R-R

Male threaded adaptor R-R

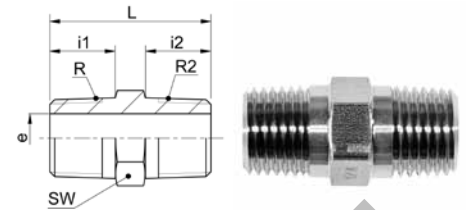

AD HN 50 R

Type -R-R2	Mat.-Nr.	bar	SW	L	i1	i2	e	kg/100
R=Rohrgewinde (kegelig)		R=Filetage-gaz BSP (conique)				R=BSP thread (tapered)		
R2=Rohrgewinde (kegelig)		R2=Filetage-gaz BSP (conique)				R2=BSP thread (tapered)		
AD HN 50-1/8-1/8	TAD.5110.042	400	12	25.0	9.5	9.5	6.0	1.050
AD HN 50-1/8-1/4	TAD.5110.044	400	14	28.0	9.5	12.5	6.0	1.910
AD HN 50-1/8-3/8	TAD.5110.046	400	17	30.0	9.5	12.5	6.0	3.340
AD HN 50-1/8-1/2	TAD.5110.048	400	22	35.0	9.5	17.5	6.0	6.640
AD HN 50-1/4-1/4	TAD.5110.104	400	14	31.0	12.5	12.5	8.0	2.070
AD HN 50-1/4-3/8	TAD.5110.106	400	17	33.0	12.5	12.5	8.0	3.460
AD HN 50-1/4-1/2	TAD.5110.108	400	22	38.0	12.5	17.5	8.0	6.680
AD HN 50-3/8-3/8	TAD.5110.166	400	17	33.0	12.5	12.5	10.5	3.330
AD HN 50-3/8-1/2	TAD.5110.168	400	22	38.0	12.5	17.5	10.5	6.390
AD HN 50-1/2-1/2	TAD.5110.228	400	22	43.0	17.5	17.5	13.0	7.060
AD HN 50-1/2-3/4	TAD.5110.232	200	27	46.5	17.5	19.0	13.0	12.090
AD HN 50-1/2-1	TAD.5110.236	100	36	48.5	17.5	21.0	13.0	21.120
AD HN 50-3/4-3/4	TAD.5110.292	200	27	48.0	19.0	19.0	21.0	7.620
AD HN 50-3/4-1	TAD.5110.296	100	36	50.0	19.0	21.0	21.0	16.340
AD HN 50-1-1	TAD.5110.414	100	36	52.0	21.0	21.0	26.0	14.470

Doppelnippel R-NPT

Mamelon double R-NPT

Male threaded adaptor R-NPT

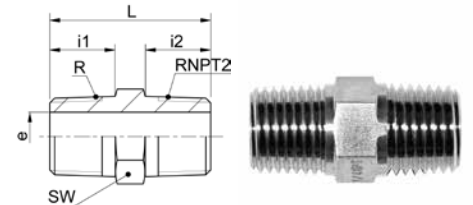

AD HN 50 R-NPT

Type -R-RNPT2	Mat.-Nr.	bar	SW	L	i1	i2	e	kg/100
R=Rohrgewinde (kegelig)		R=Filetage-gaz BSP (conique)				R=BSP thread (tapered)		
RNPT2=NPT Gewinde		RNPT2=Filetage NPT				RNPT2=NPT thread		
AD HN 50-1/8-1/8 NPT	TAD.5114.042	400	12	25.0	9.5	9.5	6.0	1.060
AD HN 50-1/4-1/4 NPT	TAD.5114.104	400	14	31.0	12.5	12.5	8.0	2.060
AD HN 50-3/8-3/8 NPT	TAD.5114.166	330	17	33.0	12.5	12.5	10.5	3.260
AD HN 50-1/2-1/2 NPT	TAD.5114.228	330	22	43.0	17.5	17.5	13.0	6.850
AD HN 50-3/4-3/4 NPT	TAD.5114.292	200	27	48.0	19.0	19.0	21.0	7.370
AD HN 50-1-1 NPT	TAD.5114.414	200	36	52.0	21.0	21.0	26.0	13.760

Doppelnippel NPT-NPT

Mamelon double NPT-NPT

Male threaded adaptor NPT-NPT

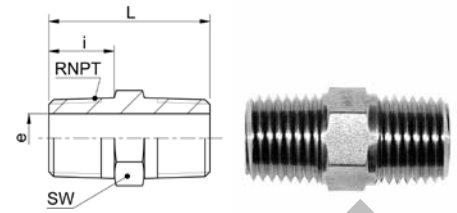

AD HN 50 NPT-NPT

Type -RNPT	Mat.-Nr.	bar	SW	L	i	e	kg/100
RNPT=NPT Gewinde	RNPT=Filetage NPT				RNPT=NPT thread		
AD HN 50-1/8 NPT-1/8 NPT	TAD.5111.042	400	12	25.0	9.5	6.0	1.110
AD HN 50-1/4 NPT-1/4 NPT	TAD.5111.104	400	14	31.0	12.5	8.0	2.140
AD HN 50-3/8 NPT-3/8 NPT	TAD.5111.166	330	17	33.0	12.5	10.5	3.340
AD HN 50-1/2 NPT-1/2 NPT	TAD.5111.228	330	22	43.0	17.5	13.0	6.940
AD HN 50-3/4 NPT-3/4 NPT	TAD.5111.292	330	27	48.0	19.0	21.0	7.450
AD HN 50-1 NPT-1 NPT	TAD.5111.414	200	36	52.0	21.0	26.0	13.690

Doppelnippel G-G

60°-Innenkonus

Mamelon double G-G

cône intérieur 60°

Male threaded adaptor G-G

60° inner cone

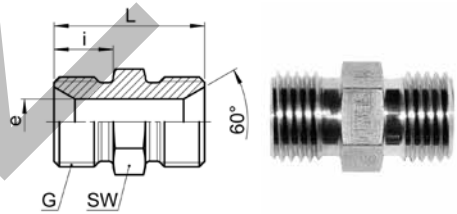

ADH HNC 50

Type -G	Mat.-Nr.	bar	SW	L	i	e	kg/100
G=Rohrgewinde (zylindrisch)	G=Filetage-gaz BSP (cylindrique)				G=BSP thread (parallel)		
ADH HNC 50-1/4 -1/4	496.5100.104	400	14	26.0	10.0	7.5	1.490
ADH HNC 50-3/8 -3/8	496.5100.166	400	17	28.0	11.0	8.5	2.560

Doppelnippel G-R

60° Innenkonus / kegeliges Aussengewinde

Mamelon double G-R

cône intérieur 60° / filetage conique

Male threaded adaptor G-R

60° inner cone / tapered male thread

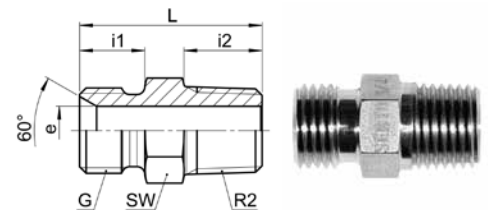

ADH HNIC 50

Type -G-R2	Mat.-Nr.	bar	SW	L	i1	i2	e	kg/100
G=Rohrgewinde (zylindrisch)	G=Filetage-gaz BSP (cylindrique)				G=BSP thread (parallel)			
R2=Rohrgewinde (kegelig)	R2=Filetage-gaz BSP (conique)				R2=BSP thread (tapered)			
ADH HNIC 50-1/8 -1/8	496.5210.042	400	10	22.0	9.0	8.0	4.0	0.760
ADH HNIC 50-1/4 -1/4	496.5210.104	400	14	28.0	11.0	12.0	7.5	1.120
ADH HNIC 50-3/8 -3/8	496.5210.166	400	17	30.0	11.5	12.0	10.0	3.280
ADH HNIC 50-1/2 -1/2	496.5210.228	400	22	34.0	12.0	14.0	12.0	5.480
ADH HNIC 50-3/4 -3/4	496.5210.292	200	27	38.0	13.0	16.0	17.0	9.000

Sechskantnippel G-G

60° Innenkonus / Innengewinde

Adaptateur hexagonal G-G

cône intérieure 60° / taraudage

Hexagonal nipple G-G

60° inner cone / female thread

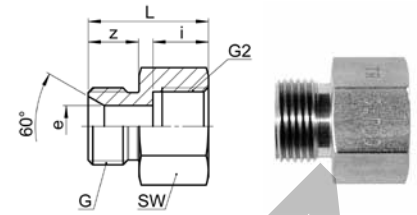

ADH A 50

Type -G -G2	Mat.-Nr.	bar	SW	L	i	z	e	kg/100
G=Rohrgewinde (zylindrisch)								
G2=Rohrgewinde (zylindrisch)								
ADH A 50- $\frac{3}{8}$ - $\frac{3}{8}$	496.5320.166	200	22	26.0	12.0	11.0	9.0	3.870
ADH A 50- $\frac{1}{2}$ - $\frac{1}{2}$	496.5320.228	200	27	29.0	14.0	12.0	12.0	6.110

Rohrdoppelnippel R

Mamelon double tubulaire R

Tube double threaded nipple R

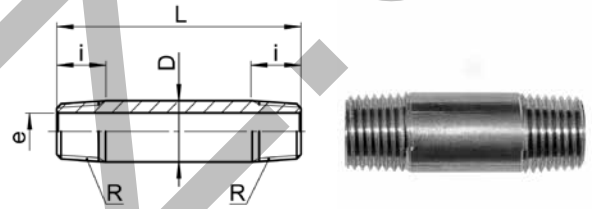

AD CN 50

Type -R xL	Mat.-Nr.	bar	L	D	i	e	kg/100
R=Rohrgewinde (kegelig)							
AD CN 50- $\frac{1}{8}$ x40	TAD.5150.021	400	40.0	10.0	8.0	6.0	1.400
AD CN 50- $\frac{1}{8}$ x60	TAD.5150.023	400	60.0	10.0	8.0	7.5	2.200
AD CN 50- $\frac{1}{4}$ x40	TAD.5150.042	400	40.0	14.0	9.0	9.0	2.400
AD CN 50- $\frac{1}{4}$ x60	TAD.5150.045	400	60.0	14.0	9.0	9.0	2.860
AD CN 50- $\frac{1}{4}$ x80	TAD.5150.049	400	80.0	14.0	9.0	9.0	5.700
AD CN 50- $\frac{1}{4}$ x100	TAD.5150.053	400	100.0	14.0	9.0	9.0	7.100
AD CN 50- $\frac{1}{4}$ x150	TAD.5150.058	400	150.0	14.0	9.0	9.0	8.000
AD CN 50- $\frac{3}{8}$ x60	TAD.5150.060	400	60.0	17.0	12.0	12.0	4.000
AD CN 50- $\frac{1}{2}$ x40	TAD.5150.082	400	40.0	21.0	13.0	16.0	3.600
AD CN 50- $\frac{1}{2}$ x60	TAD.5150.084	400	60.0	21.0	13.0	16.0	5.970
AD CN 50- $\frac{1}{2}$ x80	TAD.5150.086	400	80.0	21.0	13.0	16.0	8.100
AD CN 50- $\frac{1}{2}$ x100	TAD.5150.088	400	100.0	21.0	13.0	16.0	11.050
AD CN 50- $\frac{1}{2}$ x150	TAD.5150.093	400	150.0	21.0	13.0	16.0	15.900
AD CN 50- $\frac{3}{4}$ x80	TAD.5150.126	200	80.0	27.0	17.0	22.0	10.850
AD CN 50- $\frac{3}{4}$ x100	TAD.5150.128	200	100.0	27.0	17.0	20.0	12.800
AD CN 50- $\frac{3}{4}$ x150	TAD.5150.134	200	150.0	27.0	17.0	22.0	20.300
AD CN 50-1 x60	TAD.5150.162	100	60.0	34.0	17.0	28.0	11.600
AD CN 50-1 x80	TAD.5150.164	100	80.0	34.0	17.0	28.0	13.300
AD CN 50-1 x100	TAD.5150.166	100	100.0	34.0	17.0	28.0	14.900
AD CN 50-1 x150	TAD.5150.171	100	150.0	34.0	17.0	28.0	32.200
AD CN 50-1 x180	TAD.5150.174	100	180.0	34.0	17.0	28.0	38.600
AD CN 50-1 x200	TAD.5150.176	100	200.0	34.0	17.0	28.0	43.700

Rohrnippel G

Mamelon tubulaire G

Tube nipple G

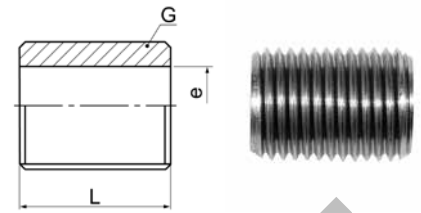

AD CNS 50

Type -G	Mat.-Nr.	bar	L	e	kg/100
G=Rohrgewinde (zylindrisch)	G=Filetage-gaz BSP (cylindrique)			G=BSP thread (parallel)	
AD CNS 50-1/4	TAD.5180.104	400	18.0	9.0	0.600
AD CNS 50-3/8	TAD.5180.166	400	22.0	12.0	1.070
AD CNS 50-1/2	TAD.5180.228	400	25.0	16.0	1.440
AD CNS 50-3/4	TAD.5180.292	200	30.0	22.0	2.650

Rohranschweissnippel R

Embout fileté à souder R

Weld-on nipple R

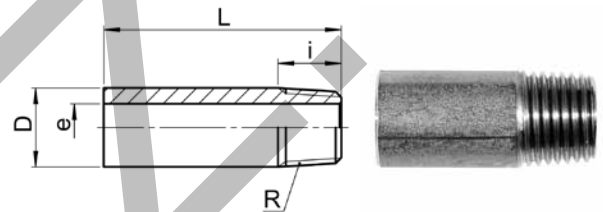

AD CNW 50

Type -R	Mat.-Nr.	bar	L	D	i	e	kg/100
R=Rohrgewinde (kegelig)	R=Filetage-gaz BSP (conique)					R=BSP thread (tapered)	
AD CNW 50-1/8	TAD.5170.020	400	30.0	10.0	8.0	6.0	0.900
AD CNW 50-1/4	TAD.5170.040	400	30.0	13.5	9.0	9.0	1.100
AD CNW 50-3/8	TAD.5170.060	400	30.0	17.0	12.0	12.0	1.760
AD CNW 50-1/2	TAD.5170.080	400	35.0	21.0	13.0	16.5	3.600
AD CNW 50-3/4	TAD.5170.120	200	40.0	27.0	15.0	21.5	5.200
AD CNW 50-1	TAD.5170.160	100	40.0	34.0	17.0	28.0	5.250

Rohranschweissnippel NPT

Embout fileté à souder NPT

Weld-on nipple NPT

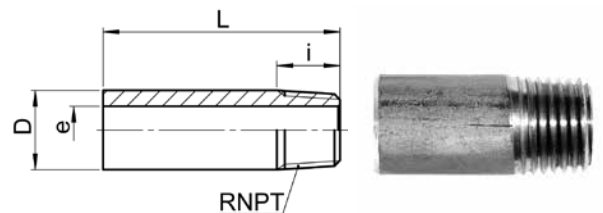

AD CNW 50 NPT

Type -RNPT	Mat.-Nr.	bar	L	D	i	e	kg/100
RNPT=NPT Gewinde	RNPT=Filetage NPT					RNPT=NPT thread	
AD CNW 50-1/8 NPT	TAD.5171.020	400	30.0	10.0	8.5	6.0	0.720
AD CNW 50-1/4 NPT	TAD.5171.040	400	30.0	13.5	12.5	8.8	1.140
AD CNW 50-3/8 NPT	TAD.5171.060	330	30.0	17.0	12.0	12.0	2.100
AD CNW 50-1/2 NPT	TAD.5171.080	330	35.0	21.0	13.0	16.5	2.400
AD CNW 50-3/4 NPT	TAD.5171.120	330	40.0	27.0	17.5	22.0	3.320
AD CNW 50-1 NPT	TAD.5171.160	200	40.0	33.5	21.0	27.5	5.010

Übergangsnippel G-R

Adaptateur femelle G - mâle R

Adaptor female G - male R

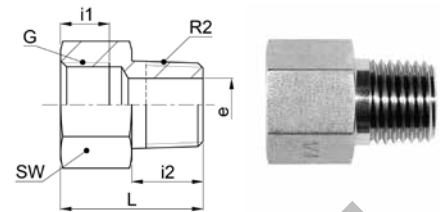

AD A 50 G-R

Type -G-R2	Mat.-Nr.	bar	SW	L	i1	i2	e	kg/100
G=Rohrgewinde (zylindrisch)	G=Filetage-gaz BSP (cylindrique)			G=BSP thread (parallel)				
R2=Rohrgewinde (kegelig)	R2=Filetage-gaz BSP (conique)			R2=BSP thread (tapered)				
AD A 50-1/8-1/8	TAD.5120.042	400	14	21.0	8.0	9.5	6.0	1.230
AD A 50-1/8-1/4	TAD.5130.044	400	14	18.5	8.0	12.0	8.7	1.140
AD A 50-1/8-3/8	TAD.5130.046	400	17	20.5	8.0	12.0	8.7	2.460
AD A 50-1/8-1/2	TAD.5130.048	400	22	25.5	8.0	14.0	8.7	5.510
AD A 50-1/4-1/8	TAD.5120.102	400	17	23.0	9.0	9.5	6.0	1.780
AD A 50-1/4-1/4	TAD.5120.104	400	17	26.0	9.0	12.5	8.0	2.200
AD A 50-1/4-3/8	TAD.5130.106	400	17	20.5	9.0	12.0	11.6	1.800
AD A 50-1/4-1/2	TAD.5130.108	400	22	25.5	9.0	14.0	11.6	4.700
AD A 50-1/4-3/4	TAD.5130.110	400	27	29.0	9.0	16.0	11.6	9.580
AD A 50-3/8-1/4	TAD.5120.164	400	22	28.0	9.5	12.5	8.0	3.590
AD A 50-3/8-3/8	TAD.5120.166	400	22	27.0	9.5	12.5	10.5	3.700
AD A 50-3/8-1/2	TAD.5130.168	400	22	25.5	9.5	14.0	15.2	3.940
AD A 50-3/8-3/4	TAD.5130.170	160	27	29.0	9.5	16.0	15.2	7.650
AD A 50-3/8-1	TAD.5130.172	100	36	31.0	9.5	18.0	15.2	16.640
AD A 50-1/2-1/4	TAD.5120.224	400	27	31.0	11.5	12.5	8.0	5.820
AD A 50-1/2-3/8	TAD.5120.226	400	27	30.0	11.5	12.5	10.5	5.790
AD A 50-1/2-1/2	TAD.5120.228	400	27	35.0	11.5	17.5	13.0	7.190
AD A 50-1/2-3/4	TAD.5130.232	160	27	29.0	11.5	16.0	19.0	6.080
AD A 50-1/2-1	TAD.5130.236	100	36	31.0	14.0	20.0	19.0	14.500
AD A 50-3/4-1/2	TAD.5120.288	200	32	39.0	14.0	17.5	13.0	9.670
AD A 50-3/4-3/4	TAD.5120.292	160	32	40.0	14.0	19.0	21.0	9.170
AD A 50-3/4-1	TAD.5130.296	100	36	31.0	14.0	18.0	24.5	10.490
AD A 50-1-1/2	TAD.5120.408	200	41	45.0	17.0	17.5	13.0	18.790
AD A 50-1-3/4	TAD.5120.412	160	41	45.0	17.0	19.0	21.0	17.130
AD A 50-1-1	TAD.5120.414	100	41	45.0	17.0	21.0	26.0	17.530

Übergangsnippel G-NPT

Adaptateur femelle G - mâle NPT

Adaptor female G - male NPT

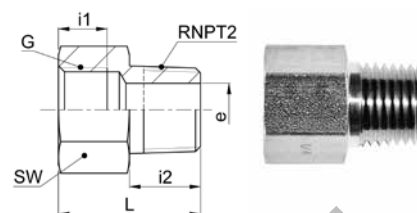

AD A 50 G-NPT

Type -G -RNPT2	Mat.-Nr.	bar	SW	L	i1	i2	e	kg/100
G=Rohrgewinde (zylindrisch)	G=Filetage-gaz BSP (cylindrique)		G=BSP thread (parallel)					
RNPT2=NPT Gewinde	RNPT2=Filetage NPT		RNPT2=NPT thread					
AD A 50-1/8-1/8 NPT	TAD.5124.042	400	14	21.0	8.0	9.5	6.0	1.280
AD A 50-1/8-1/4 NPT	TAD.5134.044	400	14	18.5	8.0	12.5	8.7	1.220
AD A 50-1/8-3/8 NPT	TAD.5134.046	400	17	20.5	8.0	12.5	8.7	2.670
AD A 50-1/8-1/2 NPT	TAD.5134.048	400	22	25.5	8.0	17.5	8.7	5.900
AD A 50-1/4-1/8 NPT	TAD.5124.102	400	17	23.0	9.0	9.5	6.0	1.830
AD A 50-1/4-1/4 NPT	TAD.5124.104	400	17	26.0	9.0	12.5	8.0	2.280
AD A 50-1/4-3/8 NPT	TAD.5134.106	400	17	20.5	9.0	12.5	11.6	1.880
AD A 50-1/4-1/2 NPT	TAD.5134.108	400	22	25.5	9.0	17.5	11.6	5.050
AD A 50-1/4-3/4 NPT	TAD.5134.110	400	27	29.0	9.0	19.0	11.6	10.200
AD A 50-3/8-1/4 NPT	TAD.5124.164	400	22	28.0	9.5	12.5	8.0	3.670
AD A 50-3/8-3/8 NPT	TAD.5124.166	400	22	27.0	9.5	12.5	10.5	3.790
AD A 50-3/8-1/2 NPT	TAD.5134.168	400	22	25.5	9.5	17.5	15.2	3.490
AD A 50-1/2-1/4 NPT	TAD.5124.224	400	27	31.0	11.5	12.5	8.0	6.150
AD A 50-1/2-3/8 NPT	TAD.5124.226	400	27	30.0	11.5	12.5	10.5	6.130
AD A 50-1/2-1/2 NPT	TAD.5124.228	400	27	35.0	11.5	17.5	13.0	7.280
AD A 50-1/2-3/4 NPT	TAD.5134.232	400	27	29.0	11.5	19.0	19.0	6.170
AD A 50-3/4-1/2 NPT	TAD.5124.288	200	32	39.0	14.0	17.5	13.0	10.180
AD A 50-3/4-3/4 NPT	TAD.5124.292	200	32	40.0	14.0	19.0	21.0	9.650
AD A 50-3/4-1 NPT	TAD.5134.296	200	36	31.0	14.0	21.0	24.5	10.780
AD A 50-1-3/4 NPT	TAD.5124.412	200	41	45.0	17.0	19.0	21.0	18.180
AD A 50-1-1 NPT	TAD.5124.414	200	41	45.0	17.0	21.0	26.0	18.470

Übergangsnippel NPT-R

Adaptateur femelle NPT - mâle R

Adaptor female NPT - male R

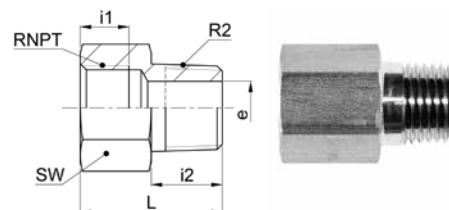

AD A 50 NPT-R

Type -RNPT -R2	Mat.-Nr.	bar	SW	L	i1	i2	e	kg/100
RNPT=NPT Gewinde	RNPT=Filetage NPT		RNPT=NPT thread					
R2=Rohrgewinde (kegelig)	R2=Filetage-gaz BSP (conique)		R2=BSP thread (tapered)					
AD A 50-1/8 NPT-1/8	TAD.5125.042	400	14	21.0	6.7	9.5	6.0	1.240
AD A 50-1/8 NPT-1/4	TAD.5135.044	400	14	18.5	6.7	12.5	8.4	1.150
AD A 50-1/4 NPT-1/4	TAD.5125.104	400	17	29.0	10.2	12.5	8.0	2.430
AD A 50-1/4 NPT-3/8	TAD.5135.106	400	17	20.5	10.2	12.5	10.8	1.870
AD A 50-1/4 NPT-1/2	TAD.5135.108	400	22	25.5	10.2	17.5	10.8	5.110
AD A 50-3/8 NPT-3/8	TAD.5125.166	400	22	29.0	10.3	12.5	10.5	4.050
AD A 50-1/2 NPT-1/2	TAD.5125.228	400	27	38.0	13.5	17.5	13.0	8.600
AD A 50-1/2 NPT-3/4	TAD.5135.232	160	27	29.0	13.5	19.0	17.7	6.830
AD A 50-3/4 NPT-3/4	TAD.5125.292	160	32	43.0	13.8	19.0	21.0	11.000
AD A 50-1 NPT-1	TAD.5125.414	160	36	45.0	17.4	21.0	26.0	12.830

Übergangsnippel NPT-NPT

Adaptateur femelle NPT - mâle NPT

Adaptor female NPT - male NPT

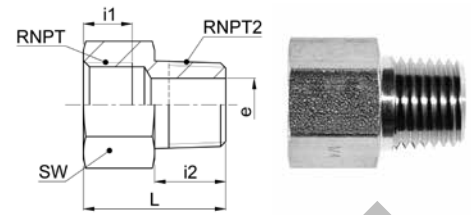

AD A 50 NPT-NPT

Type -RNPT -RNPT2	Mat.-Nr.	bar	SW	L	i1	i2	e	kg/100
RNPT=NPT Gewinde								
RNPT2=NPT Gewinde								
AD A 50-1/8 NPT -1/4 NPT	TAD.5131.044	400	14	18.5	6.7	12.5	8.4	1.280
AD A 50-1/8 NPT -3/8 NPT	TAD.5131.046	400	17	20.5	6.7	12.5	8.4	2.660
AD A 50-1/4 NPT -1/8 NPT	TAD.5121.102	400	17	26.0	10.2	9.5	6.0	2.150
AD A 50-1/4 NPT -3/8 NPT	TAD.5131.106	400	17	20.5	10.2	12.5	10.8	2.070
AD A 50-1/4 NPT -1/2 NPT	TAD.5131.108	400	22	25.5	10.2	17.5	10.8	5.150
AD A 50-3/8 NPT -1/4 NPT	TAD.5121.164	400	22	30.0	10.3	12.5	8.0	3.920
AD A 50-3/8 NPT -1/2 NPT	TAD.5131.168	400	22	25.5	10.3	17.5	13.9	3.980
AD A 50-1/2 NPT -1/4 NPT	TAD.5121.224	400	27	35.0	13.5	12.5	8.0	7.510
AD A 50-1/2 NPT -3/8 NPT	TAD.5121.226	400	27	35.0	13.5	12.5	10.5	8.030
AD A 50-1/2 NPT -3/4 NPT	TAD.5131.232	400	27	29.0	13.5	19.0	17.7	6.820
AD A 50-1/2 NPT -1 NPT	TAD.5131.236	200	36	31.0	13.5	21.0	17.7	15.880
AD A 50-3/4 NPT -1/2 NPT	TAD.5121.288	400	32	43.0	13.8	17.5	13.0	12.030
AD A 50-3/4 NPT -1 NPT	TAD.5131.296	200	36	31.0	13.8	21.0	22.5	11.920
AD A 50-1 NPT -1/2 NPT	TAD.5121.408	200	36	48.0	17.4	17.5	13.0	14.540
AD A 50-1 NPT -3/4 NPT	TAD.5121.412	200	36	48.0	17.4	19.0	21.0	13.110

Muffe lang G

Manchon long G

Threaded socket long G

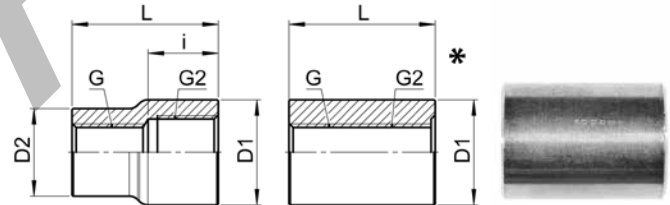

AD C 50

Type -G -G2	Mat.-Nr.	bar	L	D1	D2	i	kg/100
G=Rohrgewinde (zylindrisch)							
G2=Rohrgewinde (zylindrisch)							
AD C 50-1/8-1/8 *	TAD.5140.042	400	17.0	14.0	0.0	0.0	1.150
AD C 50-1/8-1/4	TAD.5140.044	400	25.0	18.0	15.0	17.0	2.540
AD C 50-1/4-1/4	TAD.5140.104	400	25.0	18.0	0.0	0.0	2.150
AD C 50-1/4-3/8	TAD.5140.106	400	30.0	22.5	17.5	16.0	5.140
AD C 50-1/4-1/2	TAD.5140.108	400	37.0	28.0	18.0	17.0	8.600
AD C 50-3/8-3/8 *	TAD.5140.166	400	27.0	22.0	0.0	0.0	3.600
AD C 50-3/8-1/2	TAD.5140.168	400	34.0	28.0	22.0	20.0	7.660
AD C 50-1/2-1/2	TAD.5140.228	400	34.0	27.0	0.0	0.0	5.760
AD C 50-1/2-3/4	TAD.5140.232	200	39.0	33.0	27.0	18.0	13.860
AD C 50-3/4-3/4 *	TAD.5140.292	200	36.0	33.0	0.0	0.0	8.600
AD C 50-3/4-1	TAD.5140.296	200	45.0	40.0	33.0	21.0	26.340
AD C 50-3/4-1 1/4	TAD.5140.298	200	50.0	50.0	33.0	22.0	29.310
AD C 50-1-1 *	TAD.5140.414	200	43.0	40.0	0.0	0.0	15.250
AD C 50-1-1 1/4	TAD.5140.418	200	50.0	50.0	40.0	30.0	34.420

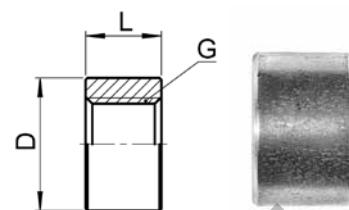
Muffe kurz G
Manchon court G
Threaded socket short G

AD CS 50

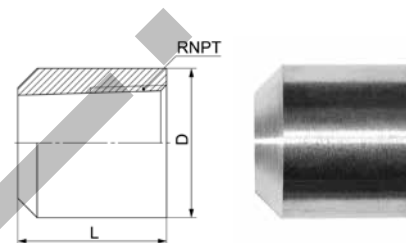
Type -G	Mat.-Nr.	bar	L	D	kg/100
G=Rohrgewinde (zylindrisch)	G=Filetage-gaz BSP (cylindrique)			G=BSP thread (parallel)	
AD CS 50-1/8	TAD.5200.042	400	8.0	14.0	0.500
AD CS 50-1/4	TAD.5200.104	400	11.0	17.0	0.900
AD CS 50-3/8	TAD.5200.166	400	12.0	22.0	1.550
AD CS 50-1/2	TAD.5200.228	400	15.0	27.0	2.600
AD CS 50-3/4	TAD.5200.292	200	17.0	32.0	3.670
AD CS 50-1	TAD.5200.414	200	19.0	40.0	6.100

Hochdruckanschweissmuffe NPT
Manchon à souder pour haute pression NPT
High-pressure weld-on socket NPT

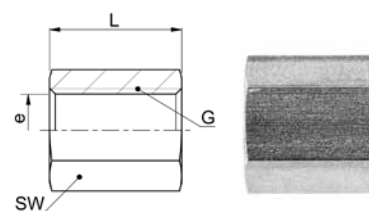
AD FCW 50 NPT

Type -RNPT	Mat.-Nr.	bar	L	D	kg/100
RNPT=NPT Gewinde	RNPT=Filetage NPT			RNPT=NPT thread	
AD FCW 50-1/8 NPT	TAD.5161.042	400	21.0	20.0	3.700
AD FCW 50-1/4 NPT	TAD.5161.104	400	25.0	25.0	6.900
AD FCW 50-3/8 NPT	TAD.5161.166	400	30.0	25.0	7.100
AD FCW 50-1/2 NPT	TAD.5161.228	400	30.0	32.0	11.600
AD FCW 50-1 NPT	TAD.5161.414	200	50.0	50.0	39.500

Sechskantmuffe G
Manchon hexagonal G
Hexagonal threaded socket G

AD HC 50

Type -G	Mat.-Nr.	bar	SW	L	e	kg/100
G=Rohrgewinde (zylindrisch)	G=Filetage-gaz BSP (cylindrique)				G=BSP thread (parallel)	
AD HC 50-1/8	TAD.5100.042	400	17	17.0	8.6	2.280
AD HC 50-1/4	TAD.5100.104	400	22	25.0	11.4	5.500
AD HC 50-3/8	TAD.5100.166	400	22	26.0	15.0	4.400
AD HC 50-1/2	TAD.5100.228	400	27	34.0	18.6	8.430
AD HC 50-3/4	TAD.5100.292	200	32	36.0	24.1	10.690
AD HC 50-1	TAD.5100.414	200	46	43.0	30.3	33.200

Sechskantmuffe G reduziert

Manchon hexagonal G réduit

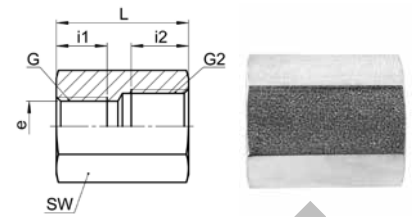
Hexagonal threaded socket G reduced



AD HRC 50

Type -G-G2	Mat.-Nr.	bar	SW	L	i1	i2	e	kg/100
G=Rohrgewinde (zylindrisch)								
G2=Rohrgewinde (zylindrisch)								
AD HRC 50-1/8-1/4	TAD.5100.044	400	22	25.0	8.0	9.0	8.6	5.940
AD HRC 50-1/8-3/8	TAD.5100.046	400	22	30.0	8.0	9.5	8.6	6.500
AD HRC 50-1/8-1/2	TAD.5100.048	400	27	41.0	8.0	11.5	8.6	14.100
AD HRC 50-1/4-3/8	TAD.5100.106	400	22	29.0	9.0	9.5	11.4	5.750
AD HRC 50-1/4-1/2	TAD.5100.108	400	27	40.0	9.0	11.5	11.4	12.950
AD HRC 50-3/8-1/2	TAD.5100.168	400	27	38.0	9.5	11.5	15.0	10.060
AD HRC 50-1/2-3/4	TAD.5100.232	200	32	41.0	11.5	14.0	18.6	15.200
AD HRC 50-1/2-1	TAD.5100.236	200	46	51.0	11.5	17.0	18.6	48.710

Rohrkappe G

Capuchon G

Hexagonal cap G

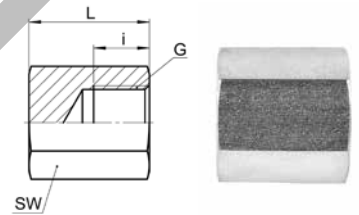

AD HCP 50

Type -G	Mat.-Nr.	bar	SW	L	i	kg/100
G=Rohrgewinde (zylindrisch)						
G=Filetage-gaz BSP (cylindrique)						
G=BSP thread (parallel)						
AD HCP 50-1/8	TAD.5000.020	400	17	19.0	8.0	2.760
AD HCP 50-1/4	TAD.5000.040	400	22	24.0	9.0	5.940
AD HCP 50-3/8	TAD.5000.060	400	22	27.0	9.5	5.880
AD HCP 50-1/2	TAD.5000.080	400	27	37.0	11.5	12.700
AD HCP 50-3/4	TAD.5000.120	200	32	38.0	14.0	16.370
AD HCP 50-1	TAD.5000.160	200	46	44.0	17.0	43.200

Verschlusschraube R

mit Aussen-6kt.

Bouchon fileté R

à six pans

Screw plug R

with hex-nut

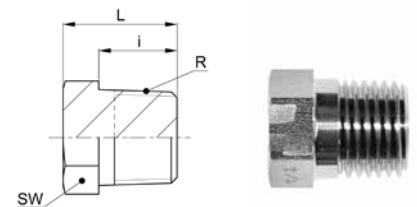

AD HP 50 R

Type -R	Mat.-Nr.	bar	SW	L	i	kg/100
R=Rohrgewinde (kegelig)						
R=Filetage-gaz BSP (conique)						
R=BSP thread (tapered)						
AD HP 50-1/8	TAD.5020.020	400	12	12.5	8.0	1.020
AD HP 50-1/4	TAD.5020.040	400	14	17.5	12.0	1.900
AD HP 50-3/8	TAD.5020.060	400	17	18.0	12.0	3.290
AD HP 50-1/2	TAD.5020.080	400	22	21.0	14.0	6.550
AD HP 50-3/4	TAD.5020.120	160	27	24.0	16.0	11.680
AD HP 50-1	TAD.5020.160	160	36	28.0	18.0	20.540

Verschlusschraube NPT

mit Aussen-6kt.

Bouchon fileté NPT

à six pans

Screw plug NPT

with hex-nut

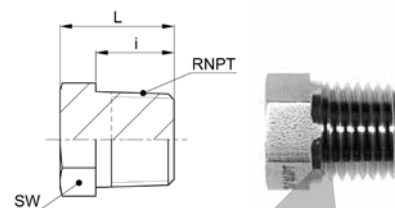

AD HP 50 NPT

Type -RNPT	Mat.-Nr.	bar	SW	L	i	kg/100
RNPT=NPT Gewinde	RNPT=Filetage NPT				RNPT=NPT thread	
AD HP 50-1/8 NPT	TAD.5021.020	400	12	15.5	9.5	1.070
AD HP 50-1/4 NPT	TAD.5021.040	400	14	18.5	12.5	1.973
AD HP 50-3/8 NPT	TAD.5021.060	400	17	20.5	12.5	3.370
AD HP 50-1/2 NPT	TAD.5021.080	400	22	25.5	17.5	6.647
AD HP 50-3/4 NPT	TAD.5021.120	200	27	29.0	19.0	11.756
AD HP 50-1 NPT	TAD.5021.160	200	36	31.0	21.0	20.472

Verschlusschraube R

mit Innen-6kt.

Bouchon fileté R

avec six pans creux

Screw plug R

locked with Allen key

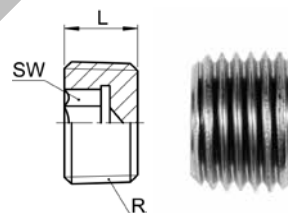

AD SP 50

Type -R	Mat.-Nr.	bar	SW	L	kg/100
R=Rohrgewinde (kegelig)	R=Filetage-gaz BSP (conique)				R=BSP thread (tapered)
AD SP 50-1/8	TAD.5010.020	400	5	8.0	0.340
AD SP 50-1/4	TAD.5010.040	400	7	10.0	0.740
AD SP 50-3/8	TAD.5010.060	400	8	10.0	1.250
AD SP 50-1/2	TAD.5010.080	400	10	10.0	1.940
AD SP 50-3/4	TAD.5010.110	160	12	12.0	3.800
AD SP 50-1	TAD.5010.160	160	17	12.0	5.760

Verschlusschraube G

mit Aussen-6kt.

Bouchon fileté G

à six pans

Screw plug G

with hex-nut

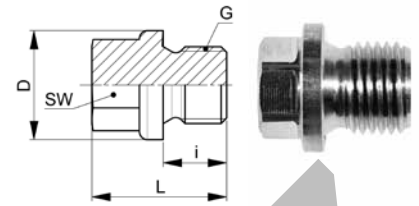

AD HPS 50

Type -G	Mat.-Nr.	bar	SW	L	D	i	kg/100
G=Rohrgewinde (zylindrisch)	G=Filetage-gaz BSP (cylindrique)		G=BSP thread (parallel)				
AD HPS 50-1/8	TAD.5030.020	400	10	17.0	14.0	8.0	1.160
AD HPS 50-1/4	TAD.5030.040	400	13	21.0	18.0	12.0	2.600
AD HPS 50-3/8	TAD.5030.060	400	17	21.0	22.0	12.0	3.960
AD HPS 50-1/2	TAD.5030.080	400	19	26.0	26.0	14.0	6.960
AD HPS 50-3/4	TAD.5030.120	200	24	30.0	32.0	16.0	12.620
AD HPS 50-1	TAD.5030.160	200	27	32.0	39.0	16.0	19.900

Einschraubgewinde nach DIN 3852-2 Form A. Beim Einbau empfiehlt sich die Verwendung einer Dichtscheibe (z.B. SO 40007). Die Dichtung muss bei Bedarf separat bestellt werden.

Filetage mâle selon DIN 3852-2 Forme A. L'utilisation d'un joint (par exemple SO 40007) est recommandée pour l'installation. Si nécessaire, le joint correspondant doit être commandé séparément.

Male adaptor thread according to DIN 3852-2 Form A. The use of a sealing washer (e.g. SO 40007) is recommended for installation. If required, the corresponding washer must be ordered separately.

Verschlusschraube G

mit Aussen-6kt. und Conovor O-Ringabdichtung (FKM)

Bouchon fileté G

à six pans, avec joint torique système Conovor (FKM)

Screw plug G

with hex-nut and Conovor O-ring seal (FKM)

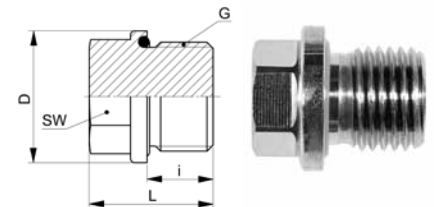

AD HPO 50

Type -G	Mat.-Nr.	bar	SW	L	D	i	O-Ring	kg/100
G=Rohrgewinde (zylindrisch)	G=Filetage-gaz BSP (cylindrique)		G=BSP thread (parallel)					
AD HPO 50-1/8	TAD.5040.020	400	10	17.0	14.0	8.0	8.73x1.78	1.180
AD HPO 50-1/4	TAD.5040.040	400	13	21.0	18.0	12.0	11.1x1.78	2.280
AD HPO 50-3/8	TAD.5040.060	400	17	21.0	22.0	12.0	14.0x1.78	3.780
AD HPO 50-1/2	TAD.5040.080	400	19	26.0	26.0	14.0	18.72x2.62	7.000

Verschlusschraube G

mit Innen-6kt.

Bouchon fileté G

avec six pans creux

Screw plug G

locked with Allen key

AD HSP 50

Type -G	Mat.-Nr.	bar	SW	L	D	i	kg/100
G=Rohrgewinde (zylindrisch)	G=Filetage-gaz BSP (cylindrique)		G=BSP thread (parallel)				
AD HSP 50-1/8	TAD.5070.020	400	5	11.0	14.0	8.0	0.650
AD HSP 50-1/4	TAD.5070.040	400	6	15.0	18.0	12.0	1.470
AD HSP 50-3/8	TAD.5070.060	400	8	15.0	22.0	12.0	2.320
AD HSP 50-1/2	TAD.5070.080	400	10	18.0	26.0	14.0	4.350
AD HSP 50-3/4	TAD.5070.120	200	12	20.0	32.0	16.0	7.700
AD HSP 50-1	TAD.5070.160	200	17	21.0	39.0	16.0	12.000

Einschraubgewinde nach DIN 3852-2 Form A. Beim Einbau empfiehlt sich die Verwendung einer Dichtscheibe (z.B. SO 40007). Die Dichtung muss bei Bedarf separat bestellt werden.

Filetage mâle selon DIN 3852-2 Forme A. L'utilisation d'un joint (par exemple SO 40007) est recommandée pour l'installation. Si nécessaire, le joint correspondant doit être commandé séparément.

Male adaptor thread according to DIN 3852-2 Form A. The use of a sealing washer (e.g. SO 40007) is recommended for installation. If required, the corresponding washer must be ordered separately.

Verschlusschraube G

mit Innen-6kt. und Conovor O-Ringabdichtung (FKM)

Bouchon fileté G

avec six pans creux et joint torique système Conovor (FKM)

Screw plug G

locked with Allen key and Conovor O-ring seal (FKM)

AD HSPO 50

Type -G	Mat.-Nr.	bar	SW	L	D	i	O-Ring	kg/100
G=Rohrgewinde (zylindrisch)	G=Filetage-gaz BSP (cylindrique)		G=BSP thread (parallel)					
AD HSPO 50-1/8	TAD.5050.020	400	5	11.0	14.0	8.0	8.73x1.78	0.610
AD HSPO 50-1/4	TAD.5050.040	400	6	15.0	18.0	12.0	11.1x1.78	1.410
AD HSPO 50-3/8	TAD.5050.060	400	8	15.0	22.0	12.0	14.0x1.78	2.200
AD HSPO 50-1/2	TAD.5050.080	400	10	18.0	26.0	14.0	18.72x2.62	4.130
AD HSPO 50-3/4	TAD.5050.120	200	12	20.0	32.0	16.0	23.47x2.62	7.380

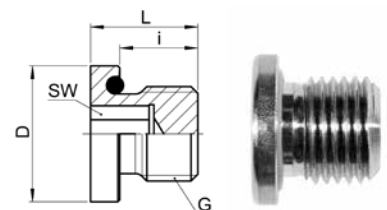
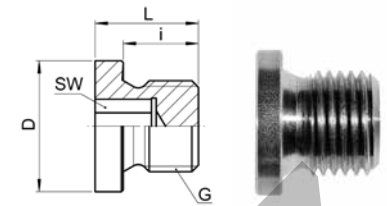

Sechskant-Kontermutter

Contre-écrou à six pans

Hexagonal counter nut

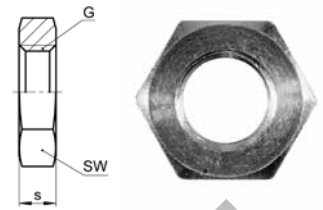

AD HCN 50

Type -G	Mat.-Nr.	SW	s	kg/100
G=Rohrgewinde (zylindrisch)	G=Filetage-gaz BSP (cylindrique)		G=BSP thread (parallel)	
AD HCN 50-1/8	TAD.5900.042	19	6.00	1.200
AD HCN 50-1/4	TAD.5900.104	22	6.00	1.430
AD HCN 50-3/8	TAD.5900.166	27	7.00	2.370
AD HCN 50-1/2	TAD.5900.228	32	8.00	3.000
AD HCN 50-3/4	TAD.5900.292	36	9.00	4.260

Aufschraub-Winkel G

Coude femelle G

Female threaded elbow G

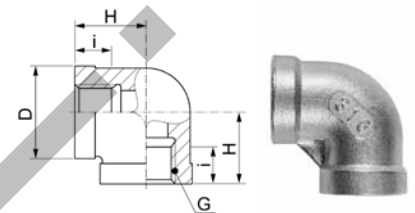

AD FE 51

Type -G	Mat.-Nr.	bar	D	H	i	kg/100
G=Rohrgewinde (zylindrisch)	G=Filetage-gaz BSP (cylindrique)			G=BSP thread (parallel)		
AD FE 51-1/8-1/8	TAD.5300.042	10	14.5	17.0	6.0	3.700
AD FE 51-1/4-1/4	TAD.5300.104	10	17.5	19.0	8.0	5.100
AD FE 51-3/8-3/8	TAD.5300.166	10	20.0	23.0	9.0	6.600
AD FE 51-1/2-1/2	TAD.5300.228	10	27.5	27.0	9.5	9.000
AD FE 51-3/4-3/4	TAD.5300.292	10	31.5	31.5	11.5	19.100
AD FE 51-1-1	TAD.5300.414	10	39.0	36.5	14.0	27.800

Alle Angaben verstehen sich als unverbindliche Richtwerte. Für nicht schriftlich bestätigte Datenauswahl übernehmen wir keine Haftung.

Toutes les spécifications sont des valeurs indicatives sans engagement. Nous déclinons toute responsabilité pour la sélection des données non confirmée par écrit.

All specifications are non-binding standard values. We assume no liability for data selection not confirmed in writing.

Einschraub-/Aufschraub-Winkel G-R

Coude mâle - femelle G-R

Male/female threaded elbow G-R

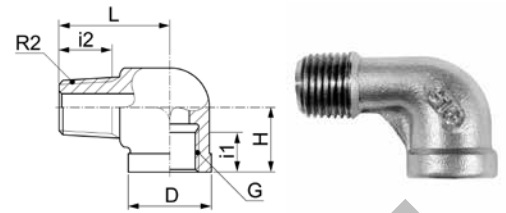

AD SE 51

Type -G-R2	Mat.-Nr.	bar	L	D	H	i1	i2	kg/100
G=Rohrgewinde (zylindrisch)								
R2=Rohrgewinde (kegelig)								

Alle Angaben verstehen sich als unverbindliche Richtwerte. Für nicht schriftlich bestätigte Datenauswahl übernehmen wir keine Haftung.

Toutes les spécifications sont des valeurs indicatives sans engagement. Nous déclinons toute responsabilité pour la sélection des données non confirmée par écrit.

All specifications are non-binding standard values. We assume no liability for data selection not confirmed in writing.

Aufschraub-T G

Té femelle G

Female threaded tee G

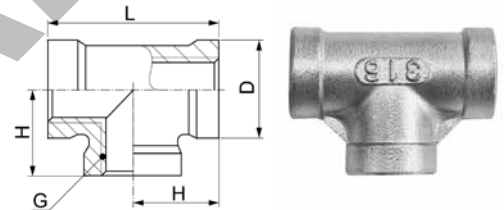

AD FT 51

Type -G	Mat.-Nr.	bar	L	D	H	kg/100
G=Rohrgewinde (zylindrisch)						

Alle Angaben verstehen sich als unverbindliche Richtwerte. Für nicht schriftlich bestätigte Datenauswahl übernehmen wir keine Haftung.

Toutes les spécifications sont des valeurs indicatives sans engagement. Nous déclinons toute responsabilité pour la sélection des données non confirmée par écrit.

All specifications are non-binding standard values. We assume no liability for data selection not confirmed in writing.

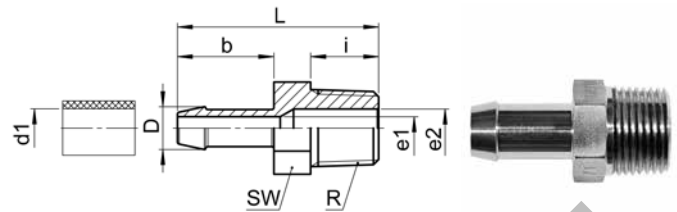
Einschraubtülle R
Douille cannelée à visser R
Male adaptor hose nozzle R

SO 50511

Type -d1 -R	Mat.-Nr.	SW	L	D	i	b	e1	e2	kg/100
R=Rohrgewinde (kegelig)	R=Filetage-gaz BSP (conique)	R=BSP thread (tapered)							
SO 50511-4-1/8	056.0511.060	10	23.0	5.0	8.0	11.0	3.0	6.0	0.560
SO 50511-4-1/4	056.0511.065	14	28.5	5.0	12.0	11.0	3.0	8.5	1.370
SO 50511-6-1/8	056.0511.100	10	29.0	7.5	8.0	17.0	4.0	6.0	0.760
SO 50511-6-1/4	056.0511.110	14	34.5	7.5	12.0	17.0	5.0	8.5	1.460
SO 50511-6-3/8	056.0511.120	17	35.0	7.5	12.0	17.0	5.0	10.5	2.290
SO 50511-6-1/2	056.0511.125	22	40.0	7.5	16.0	17.0	5.0	13.0	4.630
SO 50511-8-1/8	056.0511.160	10	29.0	9.5	8.0	17.0	6.0	6.0	0.850
SO 50511-8-1/4	056.0511.170	14	34.5	9.5	12.0	17.0	6.0	8.5	1.640
SO 50511-8-3/8	056.0511.180	17	35.0	9.5	12.0	17.0	6.0	10.5	2.470
SO 50511-8-1/2	056.0511.185	22	40.0	9.5	16.0	17.0	6.0	13.0	4.800
SO 50511-10-1/4	056.0511.270	14	36.5	11.5	12.0	19.0	8.0	8.0	1.820
SO 50511-10-3/8	056.0511.280	17	37.0	11.5	12.0	19.0	8.0	10.5	2.550
SO 50511-10-1/2	056.0511.285	22	42.0	11.5	16.0	19.0	8.0	13.0	4.910
SO 50511-12,7-1/4	056.0511.380	17	52.0	15.0	12.0	33.0	8.0	8.0	4.260
SO 50511-13-3/8	056.0511.450	17	39.0	15.0	12.0	21.0	11.0	11.0	2.640
SO 50511-13-1/2	056.0511.454	22	44.0	15.0	16.0	21.0	11.0	11.0	5.590
SO 50511-16-1/2	056.0511.566	22	49.0	18.0	16.0	26.0	13.0	13.0	5.720
SO 50511-19-1/2	056.0511.676	22	49.0	21.5	16.0	26.0	16.0	16.0	4.930
SO 50511-19-3/4	056.0511.678	27	51.0	21.5	16.5	26.0	16.0	16.0	9.170
SO 50511-25-1	056.0511.810	36	59.0	27.5	20.0	29.0	22.0	22.0	16.000

d1 = Schlauchinnendurchmesser

d1 = diamètre intérieur du tuyau

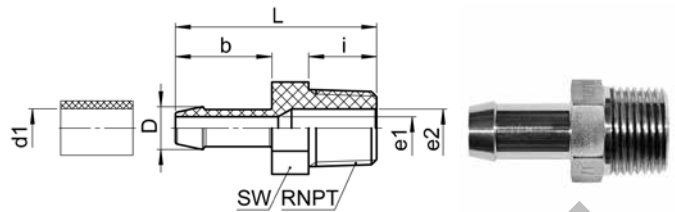
d1 = hose inside diameter

Einschraubtülle NPT
Douille cannelée à visser NPT
Male adaptor hose nozzle NPT

SO 50511 NPT

Type -d1 -RNPT	Mat.-Nr.	SW	L	D	i	b	e1	e2	kg/100
RNPT=NPT Gewinde	RNPT=Filetage NPT			RNPT=NPT thread					
SO 50511-4-1/8 NPT	056.0512.060	12	25.5	5.0	10.0	11.0	3.0	3.0	1.040
SO 50511-4-1/4 NPT	056.0512.065	14	30.5	5.0	14.0	11.0	3.0	6.5	1.900
SO 50511-6-1/8 NPT	056.0512.100	12	31.5	7.5	10.0	17.0	5.0	5.0	1.020
SO 50511-6-1/4 NPT	056.0512.110	14	36.5	7.5	14.0	17.0	5.0	6.5	1.990
SO 50511-8-1/8 NPT	056.0512.160	12	31.5	9.5	10.0	17.0	6.0	6.0	1.120
SO 50511-8-1/4 NPT	056.0512.170	14	36.5	9.5	14.0	17.0	6.0	6.0	2.230
SO 50511-10-1/4 NPT	056.0512.270	14	38.5	11.5	14.0	19.0	8.0	8.0	2.050
SO 50511-10-3/8 NPT	056.0512.280	17	39.0	11.5	14.0	19.0	8.0	8.0	3.350
SO 50511-10-1/2 NPT	056.0512.285	22	45.0	11.5	19.0	19.0	8.0	14.0	5.120
SO 50511-13-3/8 NPT	056.0512.450	17	41.0	15.0	14.0	21.0	11.0	11.0	2.930
SO 50511-13-1/2 NPT	056.0512.454	22	47.0	15.0	19.0	21.0	11.0	14.0	5.300
SO 50511-16-1/2 NPT	056.0512.566	22	52.0	18.0	19.0	26.0	13.0	13.0	6.370
SO 50511-19-1/2 NPT	056.0512.676	22	52.0	21.5	19.0	26.0	16.0	16.0	5.420
SO 50511-19-3/4 NPT	056.0512.678	30	55.0	21.5	20.0	26.0	16.0	16.0	11.440
SO 50511-25-3/4 NPT	056.0512.805	30	59.0	27.5	20.0	29.0	19.0	19.0	12.410
SO 50511-25-1 NPT	056.0512.810	36	63.0	27.5	25.0	29.0	22.0	22.0	17.430

d1 = Schlauchinnendurchmesser

d1 = diamètre intérieur du tuyau

d1 = hose inside diameter

Einschraubtülle G

mit Conovor O-Ringabdichtung (FKM)

Douille cannelée à visser G

avec joint torique système Conovor (FKM)

Male adaptor hose nozzle G

with Conovor O-ring seal (FKM)

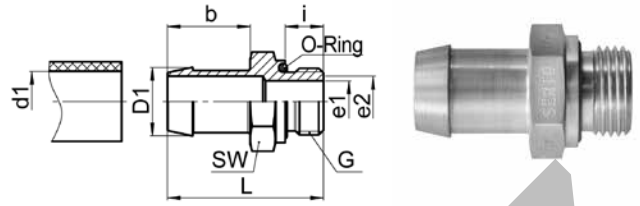

SO 10511 OR

Type -d1 -G	Mat.-Nr.	SW	L	D1	D2	i	b	t	O-Ring	e1	e2	kg/100
SO 10511-19-1/2 OR	118.0511.676	27	49.0	21.5	27.0	12.0	26.0	2.5	18.72x2.62	13.0	16.0	2.600

Einbauempfehlung:

Conseil de montage:

Recommendation for installation:

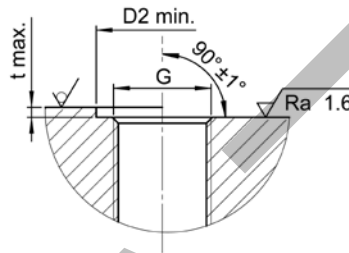

Einsatztemperaturbereich: -20 °C bis +120 °C

Die Vorteile dieser O-Ringabdichtung:

- keine Dichtmittelreste in Geräten
- einwandfreie Abdichtung
- keine Beschädigung von Geräten durch konische Gewinde
- schnelle Montage

Conovor patentierte O-Ring Abdichtung

d1 = Schlauchinnendurchmesser

Plage de température de service: -20 °C à +120 °C

Les avantages de cette étanchéité à joint torique:

- aucun reste de scellant dans les équipements
- une étanchéité parfaite
- aucun endommagement de l'équipement par le filetage conique
- facilité d'installation

Etanchéité à joint torique brevetée Conovor

d1 = diamètre intérieur du tuyau

Operating temperature range: -20 °C to +120 °C

Advantages of this O-ring seal:

- no sealing residues in devices
- perfect seal
- no damage to devices due to tapered thread
- rapid assembly

Conovor patented O-ring seal

d1 = hose inside diameter

Adapter Kunststoff

Eigenschaften, Besonderheiten

- einfache Verbindungselemente mit Innen- und Aussengewinden, Tüllen und Abschlusselementen
- zahlreiche Bauformen
- viele Kombinationsmöglichkeiten

Betriebsdruck PN

10 bar bei +23 °C (3-fache Sicherheit), höhere Drücke in Kombination mit SERTO Kunststoffrohren auf Anfrage (bar+).

Werkstoff

- PVDF (Polyvinylidenfluorid)
- PA (Polyamid 6.6)

FDA-Konformität

Polyvinylidenfluorid (PVDF) entspricht der CFR* 21, § 177.2510 der FDA (Food and Drug Administration, USA) und kann für den Einsatz im Kontakt mit Lebensmittel verwendet werden. FKM-O-Ringe sind ebenfalls FDA-konform.

*Code of Federal Regulations

Herstellung

Spritzguss

Gewinde

G = Rohrgewinde BSP (zylindrisch) ISO 228
R = Rohrgewinde (kegelig) EN 10226-1

Adaptateurs plastique

Propriétés, spécificités

- éléments simples d'assemblage avec des filetages intérieurs et extérieurs, des douilles et des éléments de fermeture
- grand nombre de formes de construction
- nombreuses possibilités de combinaison

Pression de service PN

10 bar à +23 °C (facteur de sécurité 3), pressions plus élevées en combinaison avec les tubes plastiques SERTO sur demande (bar+).

Matériaux

- PVDF (fluorure de polyvinylidène)
- PA (polyamide 6.6)

Conformité FDA

Fluorure de polyvinylidène (PVDF) est en conformité avec le CFR* 21, § 177.2510 de la FDA (Food and Drug Administration, USA) et peut être utilisé en contact avec aliments. Les joints toriques sont aussi conformes à la FDA.

*Code of Federal Regulations

Fabrication

moulage par injection

Filetages

G = filetage gas BSPP (cylindrique) ISO 228
R = filetage gas BSP (conique) EN 10226-1

Adaptors plastic

Characteristics, specialities

- simple connecting pieces with internal and external threads, hose nozzles and end elements
- large number of design types
- many possible combinations

Working pressure PN

10 bar at +23 °C (safety factor of 3), higher pressures in combination with SERTO plastic tubes on request (bar+).

Materials

- PVDF (polyvinylidene fluoride)
- PA (polyamide 6.6)

FDA-Compliance

Polyvinylidene fluoride complies with the CFR* 21, § 177.2510 of FDA (Food and Drug Administration, USA) and can be used in contact with food. FKM-O-rings are also FDA-compliant.

*Code of Federal Regulations

Manufacture

injection moulding

Threads

G = BSP pipe thread (straight) ISO 228
R = BSP pipe thread (tapered) EN 10226-1

Übergangsmuffe G-G

Adaptateur femelle G - femelle G

Female adaptor G-G

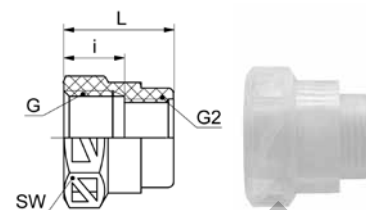

SO 20031

Type -G -G2	Mat.-Nr.	bar +	SW	L	i	kg/100
G=Rohrgewinde (zylindrisch)		G=Filetage-gaz BSP (cylindrique)		G=BSP thread (parallel)		
G2=Rohrgewinde (zylindrisch)		G2=Filetage-gaz BSP (cylindrique)		G2=BSP thread (parallel)		
SO 20031-1/8-1/8	126.0311.042	10	14	16.0	8.0	0.190
SO 20031-1/4-1/8	126.0311.044	10	17	17.0	10.0	0.310
SO 20031-3/8-1/8	126.0311.046	10	22	18.0	11.0	0.530
SO 20031-1/2-1/8	126.0311.048	10	27	21.0	14.0	1.070
SO 20031-1/4-1/4	126.0311.104	10	17	17.5	9.0	0.320
SO 20031-3/8-1/4	126.0311.106	10	22	19.0	11.0	0.550
SO 20031-1/2-1/4	126.0311.108	10	27	22.0	14.0	1.010
SO 20031-3/8-3/8	126.0311.166	10	22	19.0	9.5	0.540
SO 20031-1/2-3/8	126.0311.168	10	27	22.5	14.0	1.050

Übergangsnippel G-R

Adaptateur femelle G - mâle R

Adaptor female G- male R

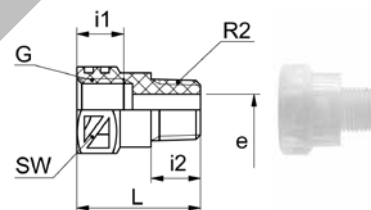

SO 20041

Type -G -R2	Mat.-Nr.	bar +	SW	L	i1	i2	e	kg/100
G=Rohrgewinde (zylindrisch)		G=Filetage-gaz BSP (cylindrique)		G=BSP thread (parallel)				
R2=Rohrgewinde (kegelig)		R2=Filetage-gaz BSP (conique)		R2=BSP thread (tapered)				
SO 20041-1/8-1/8	126.0411.042	10	14	20.0	7.0	8.0	6.0	0.220
SO 20041-1/8-1/4	126.0411.044	10	14	24.0	7.0	12.0	8.6	0.310
SO 20041-1/8-3/8	126.0411.046	10	17	25.0	7.0	12.0	8.6	0.650
SO 20041-1/8-1/2	126.0411.048	10	22	30.0	7.0	16.0	8.6	1.130
SO 20041-1/4-1/8	126.0411.102	10	17	21.0	8.0	8.0	6.0	0.340
SO 20041-1/4-1/4	126.0411.104	10	17	25.0	8.0	12.0	6.5	0.480
SO 20041-1/4-3/8	126.0411.106	10	17	25.0	8.0	12.0	11.5	0.470
SO 20041-1/4-1/2	126.0411.108	10	22	30.0	8.0	16.0	11.5	1.030
SO 20041-3/8-1/4	126.0411.164	10	22	26.0	8.5	12.0	6.7	0.690
SO 20041-3/8-3/8	126.0411.166	10	22	26.0	8.5	12.0	8.0	0.810
SO 20041-3/8-1/2	126.0411.168	10	22	30.0	8.5	16.0	15.0	0.860

Übergangsnippel G-G

mit O-Ringabdichtung (FKM)

Adaptateur femelle G - mâle G

avec joint torique (FKM)

Adaptor female G - male G

with O-ring seal (FKM)

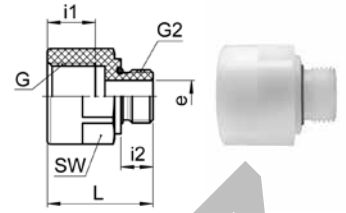

SO 20041 OR

Type -G -G2	Mat.-Nr.	bar +	SW	L	i1	i2	O-Ring	e	kg/100
G=Rohrgewinde (zylindrisch)									
G2=Rohrgewinde (zylindrisch)									
SO 20041-1/2-3/8 OR	128.0471.001	10	27	33.0	15.0	10.0	14.0x1.78	10.0	1.830

Verschlusschraube R

mit Aussen-6kt.

Bouchon fileté R

à six pans

Screw plug R

with hex-nut

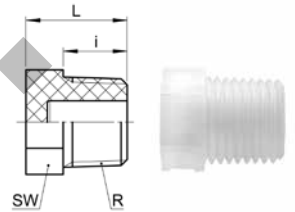

SO 20371

Type -R	Mat.-Nr.	SW	L	i	kg/100
R=Rohrgewinde (kegelig)					
SO 20371-1/8	126.0721.020	12	13.0	8.0	0.170
SO 20371-1/4	126.0721.040	14	18.5	12.0	0.370
SO 20371-3/8	126.0721.060	17	19.0	12.0	0.610
SO 20371-1/2	126.0721.080	22	24.0	16.0	1.150

Einschraubtülle R

Douille cannelée à visser R

Male adaptor hose nozzle R

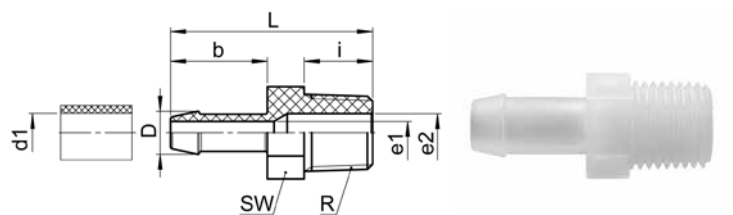

SO 20511

Type -d1 -R	Mat.-Nr.	bar +	SW	L	D	i	b	e1	e2	kg/100
R=Rohrgewinde (kegelig)										
SO 20511-4-1/8	126.0511.060	10	12	24.0	5.0	8.0	11.0	3.0	5.1	0.190
SO 20511-6-1/8	126.0511.100	10	12	30.5	7.5	8.0	17.0	4.0	5.1	0.230
SO 20511-6-1/4	126.0511.110	10	14	35.5	7.5	12.0	17.0	4.0	6.7	0.430
SO 20511-8-1/4	126.0511.170	10	14	35.5	9.5	12.0	17.0	6.0	6.7	0.440
SO 20511-10-3/8	126.0511.280	10	17	38.0	11.5	12.0	19.0	7.0	8.0	0.750
SO 20511-12-3/8	126.0511.390	10	17	38.0	13.5	12.0	19.0	10.0	10.0	0.650
SO 20511-12-1/2	126.0511.400	10	22	43.0	13.5	16.0	19.0	10.0	12.0	1.260

d1 = Schlauchinnendurchmesser

d1 = diamètre intérieur du tuyau

d1 = hose inside diameter

Doppelnippel R
Mamelon double R
Male threaded adaptor R

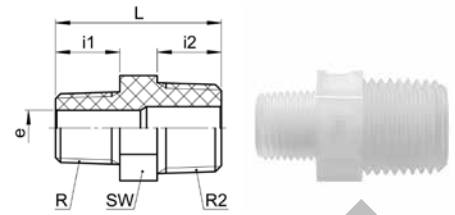
SO 21109

Type -R -R2	Mat.-Nr.	bar +	SW	L	i1	i2	e	kg/100
R=Rohrgewinde (kegelig)	R=Filetage-gaz BSP (conique)							
R2=Rohrgewinde (kegelig)	R2=Filetage-gaz BSP (conique)							
SO 21109-1/8-1/8	126.0641.042	10	12	21.0	8.0	8.0	5.1	0.230
SO 21109-1/8-1/4	126.0641.044	10	14	26.5	8.0	12.0	5.1	0.420
SO 21109-1/4-1/4	126.0641.104	10	14	30.5	12.0	12.0	6.7	0.540
SO 21109-1/4-3/8	126.0641.106	10	17	31.0	12.0	12.0	6.7	0.770
SO 21109-1/4-1/2	126.0641.108	10	22	36.0	12.0	16.0	6.7	1.310
SO 21109-3/8-3/8	126.0641.166	10	17	31.0	12.0	12.0	8.0	0.880
SO 21109-3/8-1/2	126.0641.168	10	22	36.0	12.0	16.0	8.0	1.410
SO 21109-1/2-1/2	126.0641.228	10	22	40.0	16.0	16.0	12.0	1.620
SO 21109-1/2-3/4	126.0641.232	10	27	41.5	16.0	16.5	12.0	2.210

Einschraubtülle R
Douille cannelée à visser R
Male adaptor hose nozzle R

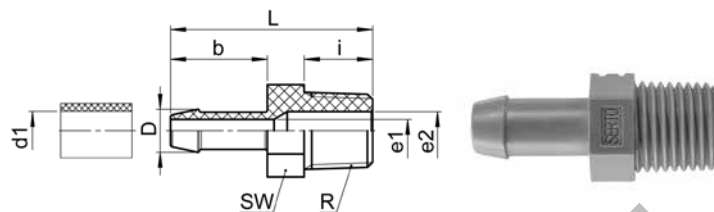

SO 30511

Type -d1 -R	Mat.-Nr.	bar +	SW	L	D	i	b	e1	e2	kg/100
R=Rohrgewinde (kegelig)	R=Filetage-gaz BSP (conique)	R=BSP thread (tapered)								
SO 30511-6-1/8	166.0511.100	10	12	30.0	7.5	8.0	17.0	4.0	5.1	0.170
SO 30511-6-1/4	166.0511.110	10	14	35.5	7.5	12.0	17.0	4.0	6.7	0.270
SO 30511-8-1/4	166.0511.170	10	14	36.0	9.5	12.0	17.5	6.0	6.7	0.340
SO 30511-10-3/8	166.0511.280	10	17	38.0	11.5	12.0	19.0	7.0	8.0	0.470
SO 30511-12-3/8	166.0511.390	10	17	38.0	13.5	12.0	19.0	10.0	10.0	0.400
SO 30511-12-1/2	166.0511.400	10	22	43.0	13.5	16.0	19.0	10.0	12.0	0.780

d1 = Schlauchinnendurchmesser

d1 = diamètre intérieur du tuyau

d1 = hose inside diameter

Rohrkompensierverbindung

Compensateur de tube

Tube compensator

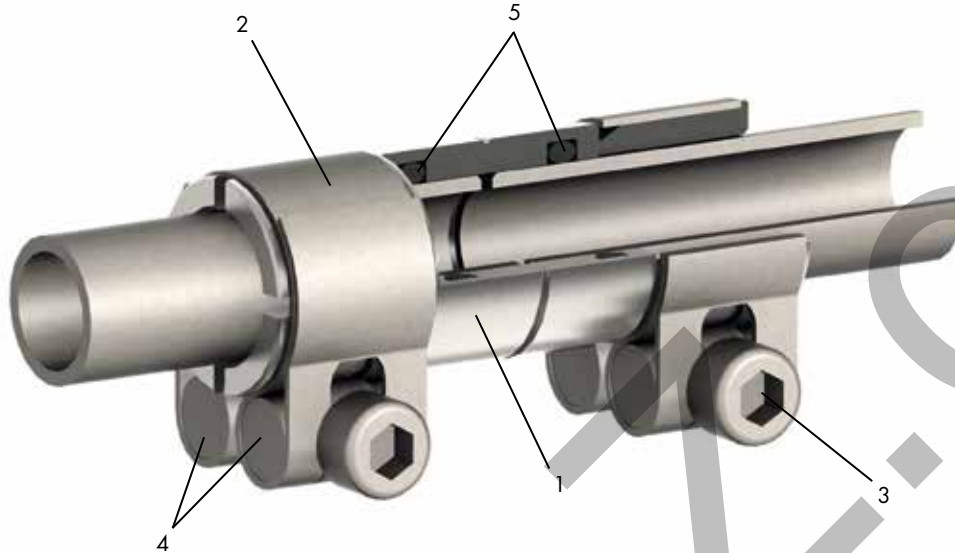
RK 51900

Nr. No. No.	Bezeichnung Désignation Description	Material Matériau Material	Nr. No. No.	Bezeichnung Désignation Description	Material Matériau Material	Nr. No. No.	Bezeichnung Désignation Description	Material Matériau Material
1	Schiebekörper Corps Body	Inox 1.4305	3	Innensechskantschraube Vis à six-pans creux Hexagon socket screw	Inox 1.4301	5*	Dichtung Joint Seal	VMQ
2	Gelenkbolzenschelle Collier articulé Hinge bolt clamp	Inox 1.4301	4	Querbolzen Boulon transversal Cross bolt	Messing CV Laiton CV Brass CV			

Spezifikationen

Betriebsdruck (PN): 5 bis 40 bar
 Temperatur: -60°C bis +250°C
 Sicherheitsfaktor: 3-fach

Merkmale

Mit der Rohrkompensierverbindung können zwei Rohre einfach miteinander verbunden werden.

* Optionen erhältlich

No. 5 - Dichtung: andere Materialien auf Anfrage

Spécifications

Pression de service (PN): 5 à 40 bar
 Température: -60°C à +250°C
 Facteur de sécurité: 3 fois

Caractéristiques

Avec le compensateur de tube, deux tubes peuvent être interconnectés d'une manière simple.

* Options disponible

No. 5 - Joint: autres joints sur demande

Specifications

Working pressure (PN): 5 to 40 bar
 Temperature: -60°C to +250°
 Safety factor: 3 times

Characteristics

With the tube compensator, two tubes can be interconnected in a simple way.

* Options available

No. 5 - Seal: other materials on request

Betriebsdruck
Pression de service
Working pressure

Der Versuchsaufbau zur Bestimmung der min. Nenndruckwerte bestand aus zwei mit einer Rohrkompensierverbindung RK 51900 verbundenen und seitlich nicht fixierten Rohrabschnitten. Daraus resultieren die angegebenen Werte mit Berücksichtigung der 3-fachen Sicherheit.

L'installation expérimentale pour déterminer les valeurs min. de pression nominale consistait en deux sections de tube non fixées sur les côtés et raccordées par un compensateur de tube RK 51900. Les valeurs indiquées ont ainsi été relevées en tenant compte de la triple sécurité.

The test setup for the determination of the min. working pressure values consisted of two tube sections, not fastened at the sides, connected to a tube compensator RK 51900. The values stated are the result of this test and in consideration of a safety factor of 3.



Versuchsaufbau / installation expérimentale / test setup

In der Praxis sind in einem geschlossenen Rohrsystem die Rohrabschnitte immer durch Rohrschellen, Wanddurchführungen, Bögen in der Leitung oder andere Befestigungen fixiert, was ein Ausgleiten aus der Rohrkompensierverbindung verhindert.

En pratique, les sections de tube dans un système de tubes fermé sont toujours fixées à l'aide de colliers de serrage, de traversées murales, de coudes dans la conduite ou d'autres fixations, ce qui les empêche de glisser hors du compensateur de tube.

Typically, the tube sections of a closed system are always fixed by tube clamps, wall ducts, bends in the tube or other fastenings, which prevent the sliding of the tube out of the compensator.

Abhängig von Anzahl, Qualität und Materialauswahl der Sicherungselemente sind deutlich höhere Betriebsdrücke als die hier angegebenen möglich. Werden die in der Praxis empfohlenen Maße für freie Rohrabschnitte eingehalten, sind Drücke von 10 bar (Personenverkehr) bis 16 bar (Güterverkehr) problemlos erreichbar.

En fonction du nombre, de la qualité et du choix des matériaux des éléments de sécurité, des pressions de service nettement plus élevées que celles indiquées ici sont possibles. Si les dimensions conseillées pour les sections de tube libres sont respectées dans la pratique, des pressions de 10 bars (transport de passagers) à 16 bars (transport de marchandises) peuvent être atteintes sans problème.

Depending on the number, quality and material of the securing elements, significantly higher operating pressures than those specified are possible. If the usually recommended measures for not-fixed tube sections are followed, pressures from 10 bar (passenger transportation) up to 16 bar (freight transportation) can easily be reached.

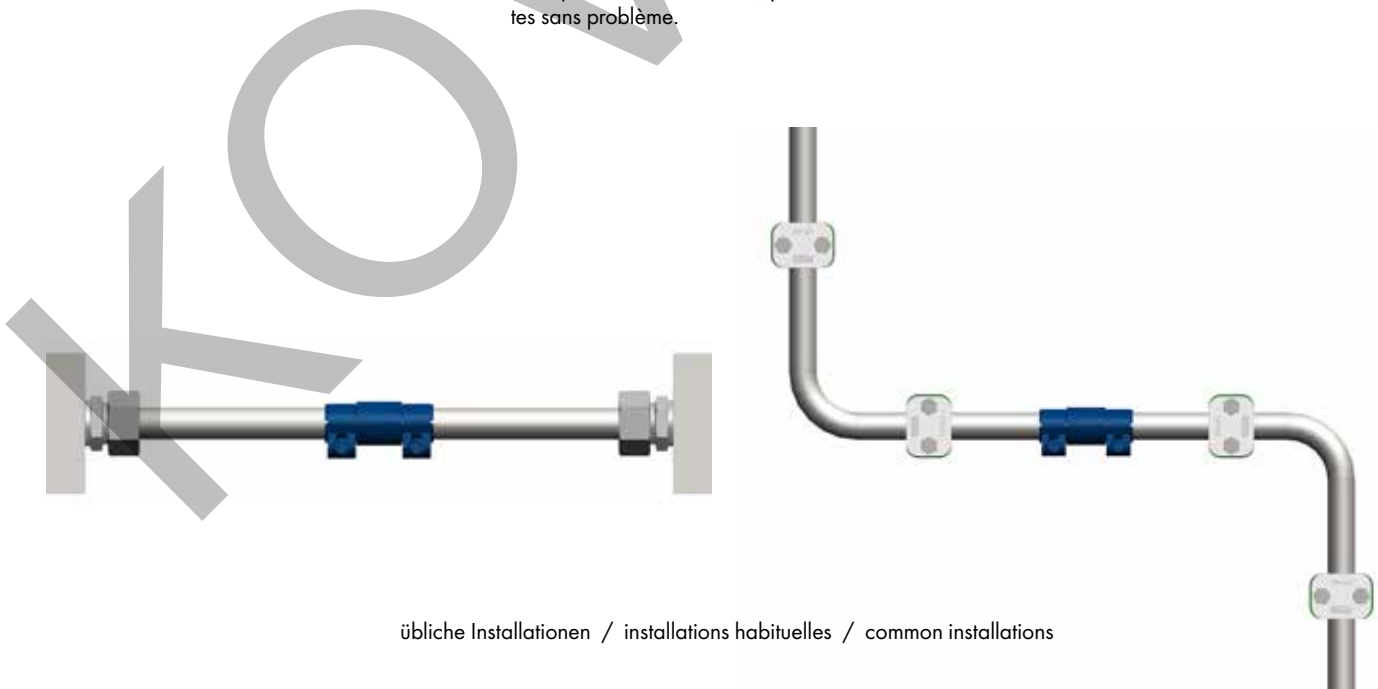

übliche Installationen / installations habituelles / common installations

Rohrkompensierverbindung

Compensateur de tube

Tube compensator

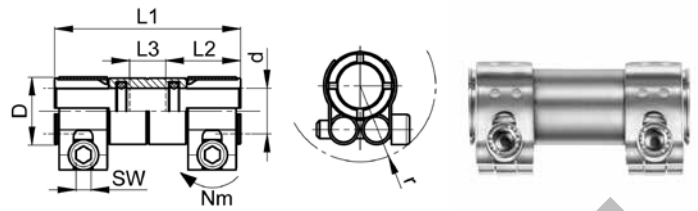

RK 51900 VMQ

Type -d	Mat.-Nr.	bar	SW	L1	L2	L3	D	Nm	r	kg/100
RK 51900-10 VMQ	YEA.510.0710	40	3	48.0	18.5	11.0	18.0	3	17	4.800
RK 51900-15 VMQ	YEA.510.0711	30	5	62.0	24.0	14.0	22.0	8	26	12.000
RK 51900-18 VMQ	YEA.510.0712	20	5	62.0	24.0	14.0	25.0	8	26	11.000
RK 51900-22 VMQ	YEA.510.0713	10	5	64.0	25.0	14.0	30.0	8	28	13.200
RK 51900-28 VMQ	YEA.510.0714	5	5	64.0	25.0	14.0	38.0	12	32	20.700
RK 51900-35 VMQ	YEA.510.0735	5	5	70.0	25.0	20.0	45.8	12	69	26.500
RK 51900-42 VMQ	YEA.510.0736	5	5	70.0	25.0	20.0	52.0	15	75	30.500

L2 = min. Einstecktiefe
 L3 = max. Rohrabstand
 Nm = Anzugsdrehmoment

L2 = profondeur d'insertion min.
 L3 = distance de tube max.
 Nm = couple de serrage

L2 = min. insertion depth
 L3 = max. tube distance
 Nm = tightening torque

Verteilerleisten

Messing, PVDF

Distributeurs

Laiton, PVDF

Manifolds

Brass, PVDF

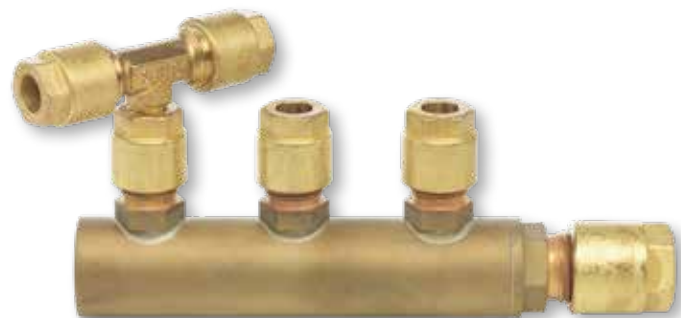

Seite/Page/Page

Verteilerleiste Messing
 Distributeur laiton
 Manifolds brass

711-718



MF ES

Verteilerleiste PVDF
 Collecteur-distributeur PVDF
 Manifolds PVDF

719-720



MF 21

KOLVANZ.COM

Verteilerleisten werden **individuell nach Ihren Angaben** gefertigt und zeichnen sich durch die vielfältigen Anschlussmöglichkeiten aus. Lieferbar sind Ausführungen mit verschiedenen Einspeisungen und vier Abgangstypen, in unterschiedlichen Längen und Ausführungen nach Kundenspezifikation.

Les éléments de distribution sont fabriqués **individuellement** conformément **à vos indications** et se distinguent par les multiples possibilités de raccordement. Sont déjà disponibles les modèles avec diverses alimentations et quatre possibilités de sorties, dans différentes longueurs et conceptions selon les spécifications du client.

Manifolds are manufactured **according to your specifications** and feature multiple connection options. Versions are available with diverse types of feed and four outlet possibilities in a variety of lengths and customised versions.



Spezifikationen

- Material
Rohre: Messing
Abgänge/Einspeisungen: Messing chemisch vernickelt siehe Kapitel 2
- Temperaturbereich -40°C bis $+180^{\circ}\text{C}$
- Standardausführung glasperlengestrahlt oder chemisch vernickelt
- Anzuschliessende Rohre siehe Kapitel i

Merkmale

- Anwendungen: Luft- und Flüssigkeitsverteiler, Einsatz sowohl im Bereich der pneumatischen Steuerungsanlagen als auch in der chemischen Industrie
- Rundprofil
- Abgänge/Einspeisungen gelötet
- beliebig kombinierbar mit Ventilen, Verschraubungen und Adaptern aus dem SERTO-Programm

Varianten

- Standardteilung der Abgänge gemäss Katalog, andere Teilungen auf Anfrage
- Kombination verschiedener Abgänge frei wählbar (abhängig von Baugrösse)
- Anordnung der Abgänge in vier Reihen à 90° möglich
- Kombination verschiedener Einspeisungen beidseitig möglich
- Befestigungsfüsse lose erhältlich

Zubehör

- Befestigungsfüsse siehe MF AC 09900
- Anbauteile siehe Kapitel Messing M, Messing G oder Messing CV
- Eckventile siehe Kapitel Ventile Metall

Spécifications

- Matériau
tube: laiton
sorties/alimentations: laiton nickelé chimique voir chapitre 2
- Plage de température -40°C à $+180^{\circ}\text{C}$
- Modèle standard grenailé aux billes de verre ou nickelé chimique
- Pour les tubes à raccorder, voir chapitre i

Caractéristiques

- Applications: distributeur d'air et de fluide, utilisation aussi bien dans le domaine des installations de commande pneumatiques que dans l'industrie chimique
- Profil rond
- Sorties/alimentations brasées
- Combinable à volonté avec les soupapes, les raccords filetés et les adaptateurs provenant du programme SERTO

Variantes

- Configuration standard des sorties conformément au catalogue, autres configurations sur demande
- Combinaison de diverses sorties possible (en fonction de la dimension)
- Agencement des sorties en quatre rangées à 90° possible
- Combinaison de diverses alimentations de chaque côté possible
- Supports disponibles séparément

Accessories

- Supports voir MF AC 09900
- Pièces de montage voir chapitre Laiton M, Laiton G ou Laiton CV
- Vannes d'équerre voir chapitre Vannes en métal

Specifications

- Material
tubes: brass
outlet/inlet: brass
chemically nickel-plated see chapter 2
- Temperature range -40°C to $+180^{\circ}\text{C}$
- Standard version glass bead blasted or chemically nickel-plated
- Connecting tubes see chapter i

Characteristics

- Applications: air and fluid distribution, for use in pneumatic control systems as well as in the chemical industry
- Round profile
- Outlets/inlets soldered
- Can be combined as desired with valves, unions and adaptors from the SERTO programme

Versions

- Standard outlet arrangement according to catalog, other arrangements on request
- Combination of outlets, freely selectable (depends on dimensions)
- Arrangement of outlets in four 90° rows possible
- Combination of various inlets possible on both sides
- Mounting brackets available separately

Accessories

- Mounting brackets see MF AC 09900
- Add-on components see chapter Brass M, Brass G or Brass CV
- Elbow valves see chapter Valves in metal

Einspeisungen
Alimentations
Inlets

Abgänge
Sorties
Outlets

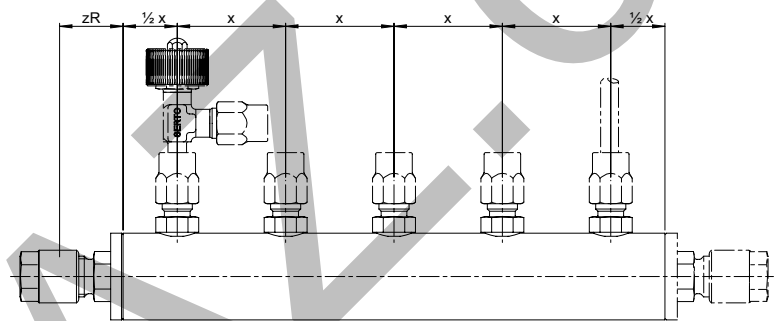
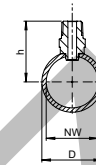
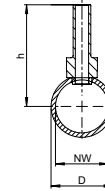
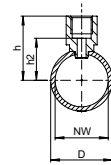
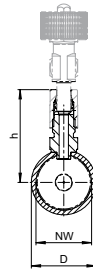
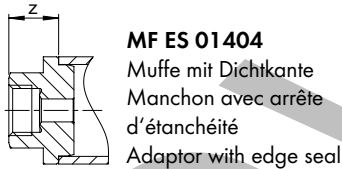
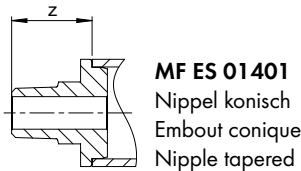
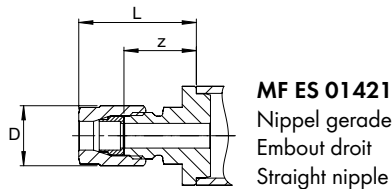
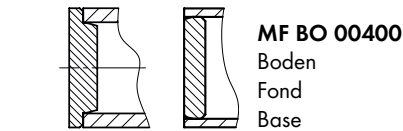

Type	Standard (x)		Non-standard		Specification	
	GP	CV	GP	CV	PN	D
NW	Mat.-Nr.		Mat.-Nr.			
13	189.4413.006	189.8413.006	189.4413.000	189.8413.000	125	17
24	-	-	189.4424.000		100	28
38	-	-	189.4438.000		64	42

GP = glasperlengestrahlt / grenailé aux billes de verre / glass bead blasted
CV = chemisch vernickelt / nickelé chimique / chemically nickel-plated

Type	Mat.-Nr.	x	h			h2		
			NW 13	NW 24	NW 38	NW 13	NW 24	NW 38
SO 01421-6-6	248.1400.100	35	25	37	44	-	-	-
SO 01421-8-9	248.1400.140	35	28	40	47	-	-	-
SO 01421-10-12	248.1400.185	40	31	43.5	50.5	-	-	-
SO 01421-12-14	248.1400.200	40	-	48	55	-	-	-
SO 01401-1/8	246.1401.020	35	25	29	36	15	19	26
SO 01401-1/4	246.1401.040	35	27	31	38	16	20	27
SO 01401-3/8	246.1401.060	40	27.5	32	39	15.5	20	27
SO 01401-1/2	246.1401.080	45	-	34.5	41.5	-	20.5	27.5
SO 01401-3/4	246.1401.120	50	-	37.5	44.5	-	20.5	27.5
SO 01402-6-A6	246.1402.060	35	38	42	49	-	-	-
SO 01402-9-A8	246.1402.080	35	42	46	53	-	-	-
SO 01402-12-A10	246.1402.100	40	43.5	48	55	-	-	-
SO 01402-14-A12	246.1402.120	45	-	51	58	-	-	-
SO 01402-14-A14	246.1402.140	50	-	54	61	-	-	-
SO 01403-1/8k	246.1403.100	35	24	28	35	-	-	-
SO 01403-1/4k	246.1403.140	35	30	34	41	-	-	-
SO 01403-3/8k	246.1403.185	40	29.5	34	41	-	-	-
SO 01403-1/2k	246.1403.200	45	-	37	44	-	-	-

Verschraubung gerade

mit Einlötnippel

Union droit

avec embout à braser

Straight union

with soldering nipple

MF ES 01421

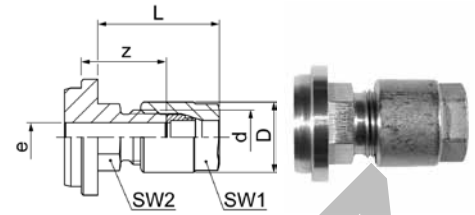

Type -NW -d	Mat.-Nr.	SW1	SW2	D	z	L	e	NW 13	NW 24	NW 38
MF ES 01421-13-6	248.1410.101	12	12	11.8	18.5	27.7	5.0	✓		
MF ES 01421-13-8	248.1410.102	14	14	17.0	19.5	30.0	7.0	✓		
MF ES 01421-13-10	248.1410.103	17	17	21.0	20.5	33.4	10.5	✓		
MF ES 01421-13-12	248.1410.104	19	22	26.0	24.0	38.5	10.0	✓		
MF ES 01421-24-6	248.1420.101	12	12	11.8	18.5	27.6	5.0		✓	
MF ES 01421-24-8	248.1420.102	14	14	17.0	20.5	31.0	7.0		✓	
MF ES 01421-24-10	248.1420.103	17	17	21.0	21.5	34.4	10.5		✓	
MF ES 01421-24-12	248.1420.104	19	22	26.0	24.0	38.5	13.0		✓	
MF ES 01421-38-8	248.1430.102	14	14	17.0	20.5	31.0	7.0			✓
MF ES 01421-38-10	248.1430.103	17	17	21.0	21.5	34.4	10.5			✓
MF ES 01421-38-12	248.1430.104	19	22	26.0	24.0	38.5	13.0			✓

für Einspeisung links / rechts

pour alimentation gauche / droite

for inlet left / right

Einlötnippel konisch

Embout à braser conique

Soldering nipple tapered

MF ES 01401

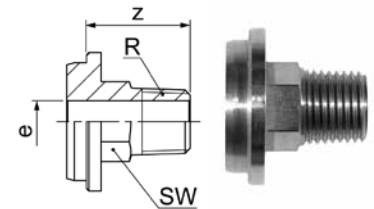

Type -NW -R	Mat.-Nr.	SW	z	e	NW 13	NW 24	NW 38
R=Rohrgewinde (kegelig)	R=Filetage-gaz BSP (conique)	R=BSP thread (tapered)					
MF ES 01401-13-1/8 K	245.1413.101	12	15.0	6.0	✓		
MF ES 01401-13-1/4 K	245.1413.102	14	21.0	8.5	✓		
MF ES 01401-13-3/8 K	245.1413.103	17	21.0	10.5	✓		
MF ES 01401-13-1/2 k	245.1413.104	22	24.0	10.0	✓		
MF ES 01401-24-1/8 K	245.1423.101	12	15.0	6.0		✓	
MF ES 01401-24-1/4 K	245.1423.102	14	21.0	8.5		✓	
MF ES 01401-24-3/8 K	245.1423.103	17	21.0	10.5		✓	
MF ES 01401-24-1/2 K	245.1423.104	22	24.0	13.0		✓	
MF ES 01401-38-1/4 K	245.1433.102	14	21.0	8.5			✓
MF ES 01401-38-3/8 K	245.1433.103	17	21.0	10.5			✓
MF ES 01401-38-1/2 K	245.1433.104	22	24.0	13.0			✓

für Einspeisung links / rechts

pour alimentation gauche / droite

for inlet left / right

d=Rohrassen- \emptyset
 e=kleinste Bohrung
 L=Mass in montiertem Zustand
 NW=Nennweite

d= \emptyset extérieur du tube
 e= \emptyset -min. de passage
 L=après montage
 NW=largeur nominale

d=tube outside diameter
 e=minimum bore
 L=installed length
 NW=nominal bore

Einlötmuffe Manchon à braser Soldering female adaptor

MF ES 01403

Type -NW -G	Mat.-Nr.	SW	b	z	e	NW 13	NW 24	NW 38
G=Rohrgewinde (zylindrisch)	G=Filetage-gaz BSP (cylindrique)		G=BSP thread (parallel)					
MF ES 01403-13-1/8	245.1411.101	14	10.0	13.0	4.0	✓		
MF ES 01403-13-1/4	245.1411.102	17	11.0	15.0	6.0	✓		
MF ES 01403-13-3/8	245.1411.103	22	12.0	19.0	8.0	✓		
MF ES 01403-13-1/2	245.1411.104	27	14.0	21.5	8.5	✓		
MF ES 01403-24-1/8	245.1421.101	14	10.0	11.0	4.0		✓	
MF ES 01403-24-1/4	245.1421.102	17	11.0	13.0	6.0		✓	
MF ES 01403-24-3/8	245.1421.103	22	12.0	14.0	8.0		✓	
MF ES 01403-24-1/2	245.1421.104	30	14.0	21.0	10.0		✓	
MF ES 01403-38-1/4	245.1431.102	17	11.0	13.0	6.0			✓
MF ES 01403-38-3/8	245.1431.103	22	12.0	14.0	8.0			✓
MF ES 01403-38-1/2	245.1431.104	27	14.0	21.0	10.0			✓

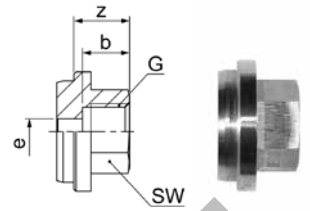

für Einspeisung links / rechts
passende Cu-Dichtung SO 40005

pour alimentation gauche / droite
joint Cu correspondant SO 40005

for inlet left / right
suitable Cu-seal SO 40005

Einlötmuffe mit Dichtkante Manchon à braser avec arrête d'étanchéité

Soldering female adaptor with edge seal

MF ES 01404

Type -NW -G	Mat.-Nr.	SW	b	z	e	NW 13	NW 24	NW 38
G=Rohrgewinde (zylindrisch)	G=Filetage-gaz BSP (cylindrique)		G=BSP thread (parallel)					
MF ES 01404-13-1/8	245.1414.101	14	7.5	10.5	4.0	✓		
MF ES 01404-13-1/4	245.1414.102	17	8.0	12.0	6.0	✓		
MF ES 01404-13-3/8	245.1414.103	22	8.5	15.5	8.0	✓		
MF ES 01404-13-1/2	245.1414.104	27	10.5	18.0	8.5	✓		
MF ES 01404-24-1/8	245.1424.101	14	7.5	11.0	4.0		✓	
MF ES 01404-24-1/4	245.1424.102	17	8.0	13.0	6.0		✓	
MF ES 01404-24-3/8	245.1424.103	22	8.5	14.0	8.0		✓	
MF ES 01404-24-1/2	245.1424.104	30	10.5	21.0	10.0		✓	
MF ES 01404-38-1/4	245.1434.102	17	8.0	13.0	6.0			✓
MF ES 01404-38-3/8	245.1434.103	22	8.5	14.0	8.0			✓
MF ES 01404-38-1/2	245.1434.104	27	10.5	21.0	8.5			✓

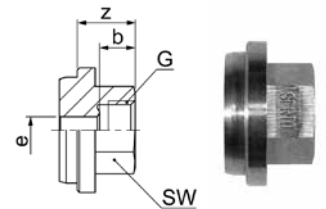

für Einspeisung links / rechts

pour alimentation gauche / droite

for inlet left / right

Fortsetzung nächste Seite

Suite à la prochaine page

Continued on next page

e=kleinste Bohrung
L=Mass in montiertem Zustand
NW=Nennweite

e=ø-min. de passage
L=après montage
NW=largeur nominale

e=minimum bore
L=installed length
NW=nominal bore

Anwendungsbeispiele:

In die Einlötmuffe MF ES 01404 kann jedes SERTO-Formteil mit dem passenden zylindrischen Gewinde eingeschraubt werden.

Dichtungsprinzip:

Bei der Montage drückt sich die Dichtkante der Übergangsmuffe in das SERTO-Formteil ein, dadurch entsteht eine einwandfreie metallische Dichtung.

Wir empfehlen, das Gewinde mit einem geeigneten Flüssigklebstoff gegen unbeabsichtigtes Lösen zu sichern.

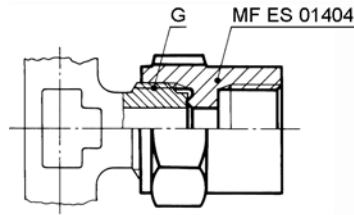
Exemples d'utilisation:

Le manchon à braser MF ES 01404 peut être vissé à toute pièce moulée SERTO avec filetage cylindrique approprié.

Principe d'étanchéité:

Lors de l'assemblage, l'arête d'étanchéité du manchon appuie sur la pièce moulée SERTO, créant ainsi une étanchéité métallique parfaite.

Nous recommandons de fixer le filetage avec une colle liquide appropriée contre le desserrage involontaire.

Sample combinations:

Any SERTO union with a suitable parallel thread can be screwed into the soldering female adaptor MF ES 01404.

Sealing principle:

During installation, the sealing edge of the female adaptor presses into the SERTO moulded part to produce a perfect metal-to-metal seal.

We recommend that the thread is secured against accidental unscrewing by means of a suitable liquid adhesive.

KONVANT

Verschraubung mit Einlötnippel

Union avec embout à braser

Adaptor union with soldering nipple

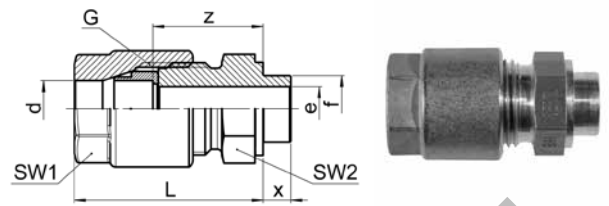
SO 01421

Type -d	Mat.-Nr.	G	SW1	SW2	L	f	z	e	NW 13	NW 24	NW 38
SO 01421-6	248.1400.100	1/8	12	12	24.0	6.0	17.0	4.0	✓	✓	✓
SO 01421-8	248.1400.140	1/4	14	14	27.0	9.0	19.0	6.0	✓	✓	✓
SO 01421-10	248.1400.185	3/8	17	17	30.5	12.0	20.0	8.0	✓	✓	✓
SO 01421-12	248.1400.200	1/2	19	22	35.0	14.0	23.5	10.0	✓	✓	✓

für Abgänge Reihen A - D

pour les sorties A - D

for outlets rows A - D

Einlötmuffe

Manchon à braser

Soldering female adaptor

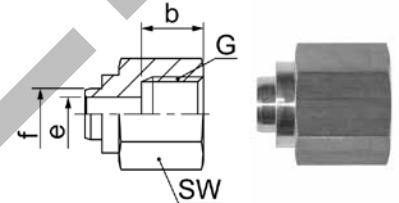
SO 01401

Type -f-G	Mat.-Nr.	SW	b	e	NW 13	NW 24	NW 38
G=Rohrgewinde (zylindrisch)	G=Filetage-gaz BSP (cylindrique)	G=BSP thread (parallel)					
SO 01401-6-1/8	246.1401.020	14	10.0	4.0	✓	✓	✓
SO 01401-9-1/4	246.1401.040	17	11.0	6.0	✓	✓	✓
SO 01401-12-3/8	246.1401.060	22	12.0	8.0	✓	✓	✓
SO 01401-14-1/2	246.1401.080	27	14.0	10.0		✓	✓
SO 01401-14-3/4	246.1401.120	32	17.0	10.0		✓	✓

 für Abgänge Reihen A - D
 passende Cu-Dichtung SO 40005

 pour les sorties A - D
 joint Cu appropriée SO 40005

 for outlets rows A - D
 suitable Cu-seal SO 40005

d=Rohraussen- \emptyset
 e=kleinste Bohrung
 L=Mass in montiertem Zustand
 NW=Nennweite

d= \emptyset extérieur du tube
 e= \emptyset -min. de passage
 L=après montage
 NW=largeur nominale

d=tube outside diameter
 e=minimum bore
 L=installed length
 NW=nominal bore

Einlötstutzen

Embout lisse à braser

Soldering stud cylindrical

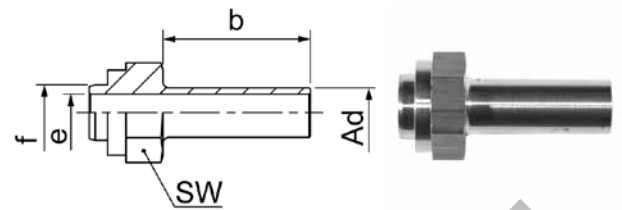

SO 01402

Type f-Ad	Mat.-Nr.	SW	b	e	NW 13	NW 24	NW 38
SO 01402-6-A6	246.1402.060	12	22.0	4.0	✓	✓	✓
SO 01402-9-A8	246.1402.080	14	24.0	6.0	✓	✓	✓
SO 01402-12-A10	246.1402.100	17	26.0	8.0	✓	✓	✓
SO 01402-14-A12	246.1402.120	22	28.0	9.0		✓	✓
SO 01402-14-A14	246.1402.140	27	30.0	11.0		✓	✓

für Abgänge Reihen A - D

pour les sorties A - D

for outlets rows A - D

Einlötnippel konisch

Embout à braser conique

Soldering nipple tapered

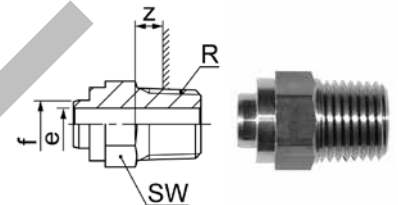

SO 01403

Type f-R	Mat.-Nr.	SW	z	e	NW 13	NW 24	NW 38
R=Rohrgewinde (kegelig)							
SO 01403-6-1/8k	246.1403.100	12	4.0	4.0	✓	✓	✓
SO 01403-9-1/4k	246.1403.140	14	6.0	6.0	✓	✓	✓
SO 01403-12-3/8k	246.1403.185	17	6.0	8.0	✓	✓	✓
SO 01403-14-1/2k	246.1403.200	22	6.0	10.0		✓	✓

für Abgänge Reihen A - D

pour les sorties A - D

for outlets rows A - D

Ad=Aussen- ϕ der Andrehung
 e=kleinste Bohrung
 L=Mass in montiertem Zustand
 NW=Nennweite

Ad= ϕ extérieur de la portée cylindrique
 e= ϕ -min. de passage
 L=après montage
 NW=largeur nominale

Ad=outside diameter of cyl. stub
 e=minimum bore
 L=installed length
 NW=nominal bore

Befestigungsfuss

Support de fixation

Mounting bracket

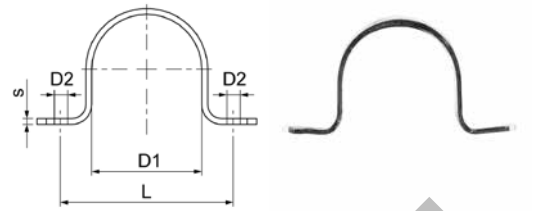

MF AC 09900

Type -NW	Mat.-Nr.	D1	D2	L	s	NW 13	NW 24	NW 38
MF AC 09900-13	185.0013.000	17.0	4.2	32.0	1.50	✓		
MF AC 09900-24	185.0024.000	28.0	5.5	44.0	1.50		✓	
MF AC 09900-38	185.0038.000	42.0	6.0	62.0	1.50			✓

KOLVANZ

Verteilerleisten PVDF

Eigenschaften, Besonderheiten

- kann mit sämtlichen PVDF Verschraubungen, Ventilen und Adaptern aus unserem Programm kombiniert werden
- nicht verwendete Abgänge können mit der Verschlusschraube verschlossen werden
- Standard mit 5, 8 und 12 Abgängen
- weitere Ausführungen auf Anfrage

Anwendung

- Luft- und Flüssigkeitsverteiler
- Einsatz sowohl im Bereich der pneumatischen Steuerungsanlagen als auch in der chemischen Industrie

Werkstoff

PVDF (Polyvinylidenfluorid)

Distributeurs PVDF

Propriétés, spécificités

- peut être combiné avec tous les raccords, robinets et adaptateurs de notre gamme PVDF
- départs qui ne sont pas utilisés peuvent être fermés avec le bouchon fileté
- standard avec 5, 8 et 12 sorties
- autres versions sur demande

Application

- distributeur d'air et de fluide
- application dans le domaine des installations de commande pneumatiques et dans l'industrie chimique

Matériau

PVDF (fluorure de polyvinylidène)

Manifolds PVDF

Characteristics, specialities

- can be combined with all unions, valves and adaptors from our PVDF program
- outlets which are not needed can be closed with the screw plug
- standard with 5, 8 and 12 outlets
- other versions on request

Application

- air and fluid distribution
- for use in pneumatic control systems and in the chemical industry

Material

PVDF (polyvinylidene fluoride)

KONVANTON

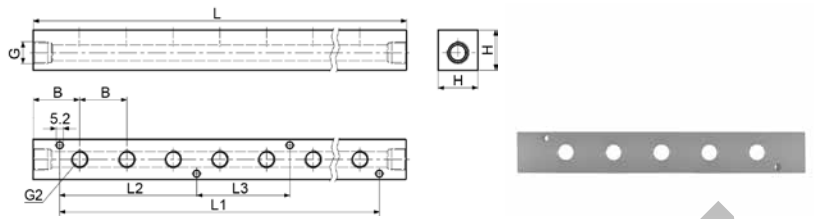
Verteilerleiste PVDF
Collecteur-distributeur PVDF
Manifolds PVDF
MF 21

Type -G -G2 -A	Mat.-Nr.	B	L	L1	L2	L3	H	kg/100
MF 21- $\frac{3}{8}$ - $\frac{1}{4}$ -5	186.2132.050	35.0	210.0	170.0			30.0	25.600
MF 21- $\frac{3}{8}$ - $\frac{1}{4}$ -8	186.2132.080	35.0	315.0	275.0	102.5	70.0	30.0	41.000
MF 21- $\frac{3}{8}$ - $\frac{1}{4}$ -12	186.2132.120	35.0	455.0	415.0	137.5	140.0	30.0	61.500

A = Abgänge

A = sorties

A = outlets

Rohre, Schläuche

**Kunststoff, Edelstahl,
Jacoflon**

Tubes, Tuyaux

**Plastique, acier inoxydable,
Jacoflon**

Tubes, Hoses

**Plastics, stainless steel,
Jacoflon**



Seite/Page/Page

Seite/Page/Page

Polyamid-Rohr (PA)
 Tube en polyamide (PA)
 Polyamide tube (PA)

724-725



Rohre aus Edelstahl 1.4301
 Tubes en acier inoxydable 1.4301
 Stainless steel tubes 1.4301

734



Polyethylen-Rohr (LD-PE)
 Tube en polyéthylène (LD-PE)
 Polyethylene tube (LD-PE)

726-727



Rohre aus Edelstahl 1.4571
 Tubes en acier inoxydable 1.4571
 Stainless steel tubes 1.4571

735



Polyurethan-Rohr (PU)
 Tube en polyuréthane (PU)
 Polyurethane tube (PU)

728



Jacoflon PTFE-Schläuche
 Jacoflon tuyau en PTFE
 Jacoflon PTFE hoses

740-741



Polytetrafluorethylen-Rohr (PTFE)
 Tube en polytétrafluorure d'éthylène (PTFE)
 Polytetrafluorethylene tube (PTFE)

729



Jacoflon Armaturen
 Jacoflon raccords
 Jacoflon fittings

742-748



Polyvinylidenfluorid-Rohr (PVDF)
 Tube en polyfluorure de vinylidène (PVDF)
 Polyvinylide fluoride tube (PVDF)

730

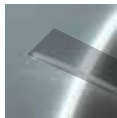

Perfluorethylenpropylen-Rohr (FEP)
 Tube en fluoréthylène propylène (FEP)
 Fluorinated ethylene propylene tube (FEP)

731



Perfluoralkoxy-Rohr (PFA)
 Tube en perfluoralkoxy (PFA)
 Perfluoroalkoxy tube (PFA)

732



SERTOflex-Rohr
 Tube SERTOflex
 SERTOflex tube

733



Eigenschaften, Besonderheiten

- speziell auf SERTO-Verbindungen abgestimmt
- Rohre und Schläuche für spezielle Anwendungen
- verschiedene Materialien

Kunststoffrohre

Speziell für Niederdruck- und Niedertemperaturbereich geeignet.

- Ablängen

Kombizangen, Scheren usw. können Rohrenden quetschen, was später oft zu Rissbildungen führt. Mit dem «Schlauch-Cutty» AC 835 von SERTO lassen sich Kunststoffrohre einwandfrei zuschneiden (siehe Kapitel 21).

- Wärmedehnung

Bei Montage zu beachten:
Grosse Wärmeausdehnung, bzw. Kontraktion bei Kälte führen zu Längenänderungen.

- Licht- und temperaturstabilisiert

Kunststoffrohre sollten in der Regel nicht direkter Sonnenbestrahlung ausgesetzt werden und nicht in Berührung mit heißen Teilen kommen bzw. nicht im Bereich von Wärmestauungen installiert werden. Ggf. schwarze Rohre verwenden. Sie sind lichtbeständig und gegen Wärmealterung unempfindlich.

Edelstahlrohre

- Werkstoff

1.4571 (≈ AISI 316Ti) und 1.4301 (= AISI 304)

- Ausführung

nahtlos, kalt gefertigt, blankgeglüht, Lieferzustand CFA, nach EN 10305-1 / EN 10216-5 / ISO 1127

- Toleranzen

EN 10305-1, Option 10 (Aussen-Ø nach Tabelle 5) und ISO 1127 (Toleranzklassen D4/T4)

Propriétés, spécificités

- spécialement adaptés aux raccords SERTO
- tubes et tuyaux pour des applications spéciales
- en matériaux différents

Tubes en matière plastique

S'utilisent essentiellement dans les domaines des faibles pressions et températures.

- Mise en longueur

Les pinces, les ciseaux etc. peuvent déformer les extrémités des tubes et être la cause de fissures ultérieures. Le «Tube-Cutty» AC 835 permet une coupe parfaite (voir chapitre 21).

- Dilatation thermique

A considérer lors du montage:
Les fortes dilatations à la chaleur resp. les contractions sous l'action du froid provoquent des changements de longueur.

- Stabilisation à la lumière et à la chaleur

Les matières plastiques ne devraient généralement pas être exposées directement aux rayons du soleil, ne pas entrer en contact avec des éléments chauds et ne pas être installées à proximité de zones chaudes. Si cela devait tout de même être le cas, utiliser des tubes en matière plastique noire qui ont été rendus insensibles à la chaleur et à la lumière.

Tubes en acier inoxydable

- Matériau

1.4571 (≈ AISI 316Ti) et 1.4301 (= AISI 304)

- Exécution

sans soudure, fabriqué à froid, recuit blanc, état de livraison CFA, selon EN 10305-1 / EN 10216-5 / ISO 1127

- Tolérances

EN 10305-1, option 10 (Ø extérieur selon table 5) et ISO 1127 (classement de tolérance D4/T4)

Characteristics, specialities

- fits the special requirements of the SERTO unions
- tubes and hoses for special applications
- different materials available

Plastic tubes

Especially suitable for low pressure and low temperature ranges.

- Cutting to length

Combination shears, scissors etc. can crush the tube ends and are often the cause for later splitting. The «Hose-Cutty» AC 835 is the ideal tool for the clean cutting (see chapter 21).

- Thermal expansion

Plastic tubing has a high thermal expansion – or contraction. Proper installation entails the consideration of the temperature-dependent dimensional changes.

- Light and temperature stabilized

Plastics should generally not be exposed to direct sunlight, should not come into contact with hot components nor installed in hot areas. Black plastic tubing should be used preferably (light and temperature stabilized).

Stainless steel tubes

- Material

1.4571 (≈ AISI 316Ti) and 1.4301 (= AISI 304)

- Type

seamless, cold finished, bright, annealed, state of delivery CFA, according to EN 10305-1 / EN 10216-5 / ISO 1127

- Tolerances

EN 10305-1, option 10 (outer Ø according to table 5) and ISO 1127 (tolerance classes D4/T4)

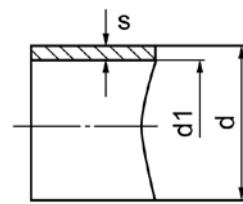
Polyamid-Rohr (PA)
Tube en polyamide (PA)
Polyamide tube (PA)

PA-ROHRE

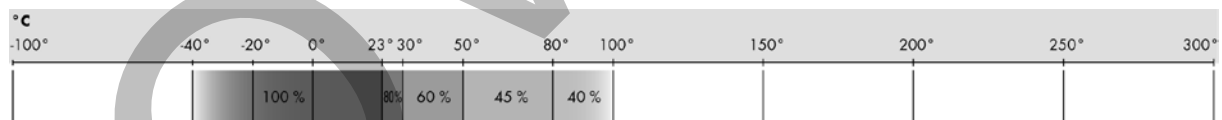
Type d / d1 x s (1)	Mat.-Nr.	bar	d	d1	s	Tol. d	B.Radius	kg/100m
PAW 4/2x1 W, 100m	421.1100.105	44	4.00	2.00	1.00	±0.10	15	0.970
PAW 5/3x1 W, 100m	421.1150.105	33	5.00	3.00	1.00	±0.10	30	1.140
PAW 6/4x1 W, 100m	421.1200.105	27	6.00	4.00	1.00	±0.10	35	1.620
PAW 6/4x1 S, 100m	421.1200.205	27	6.00	4.00	1.00	±0.10	35	1.620
PAW 6/4x1 S, 500m	421.1200.208	27	6.00	4.00	1.00	±0.10	35	1.620
PAW 6/4x1 B, 100m	421.1200.305	27	6.00	4.00	1.00	±0.10	35	1.620
PAW 6/4x1 R, 100m	421.1200.405	27	6.00	4.00	1.00	±0.10	35	1.620
PAW 6/4x1 Y, 100m	421.1200.505	27	6.00	4.00	1.00	±0.10	35	1.620
PAW 6/4x1 G, 100m	421.1200.605	27	6.00	4.00	1.00	±0.10	35	1.620
PAW 8/6x1 W, 100m	421.1300.105	19	8.00	6.00	1.00	±0.10	40	2.270
PAW 8/6x1 S, 100m	421.1300.205	19	8.00	6.00	1.00	±0.10	40	2.270
PAW 8/6x1 B, 100m	421.1300.305	19	8.00	6.00	1.00	±0.10	40	2.270
PAW 8/6x1 R, 100m	421.1300.405	19	8.00	6.00	1.00	±0.10	40	2.270
PAW 8/6x1 G, 100m	421.1300.605	19	8.00	6.00	1.00	±0.10	40	2.270
PAW 10/8x1 W, 50m	421.1350.105	15	10.00	8.00	1.00	±0.10	60	2.910
PAW 10/8x1 S, 50m	421.1350.205	15	10.00	8.00	1.00	±0.10	60	2.910
PAW 10/8x1 B, 50m	421.1350.305	15	10.00	8.00	1.00	±0.10	60	2.910
PAW 10/7x1,5 W, 50m	421.1355.105	24	10.00	7.00	1.50	±0.10	45	3.540
PAW 12/10x1 W, 50m	421.1400.105	12	12.00	10.00	1.00	±0.15	85	4.000
PAW 12/10x1 S, 50m	421.1400.205	12	12.00	10.00	1.00	±0.15	85	4.000
PAW 12/9x1.5 W, 50m	421.1405.105	19	12.00	9.00	1.50	±0.15	70	5.100
PAW 12/9x1.5 S, 50m	421.1405.205	19	12.00	9.00	1.50	±0.15	70	5.100
PAW 15/12x1.5 W, 50m	421.1555.103	15	15.00	12.00	1.50	±0.15	100	6.570

Druckauswertungsgrad in % des PN
Coefficient de pression en % de PN
Pressure coefficient in % of PN

Spezifikationen:

Werkstoff: Polyamid PA 12/PA10.12 weich
 Temperaturbereich: -40°C bis +100°C (kurzfristig: +125°C)
 Brandverhalten: gem. UL 94 HB
 Härte: Shore D65
 Berstdruck: 3-facher Betriebsdruck
 (1) Farben: W = weiss, S = schwarz, B = blau, R = rot, Y = gelb, G = grün
 Alle technischen Daten basieren auf den Herstellerangaben.

Spécifications:

Matériau: Polyamide PA 12/PA10.12 souple
 Plage de température: -40°C à +100°C (à courte terme: +125°C)
 Inflammabilité: selon UL 94 HB
 Dureté: Shore D65
 Pression d'éclatement: 3 x pression de service
 (1) Couleurs: W = blanc, S = noir, B = bleu, R = rouge, Y = jaune, G = vert
 Tous les données techniques reposent sur les indications du fabricant.

Specifications:

Material: Polyamide PA 12/PA10.12 soft
 Temperature range: -40°C to +100°C (short-term: +125°C)
 Flammability: acc. to UL 94 HB
 Hardness: Shore D65
 Burst pressure: 3 x working pressure
 (1) Colors: W = white, S = black, B = blue, R = red, Y = yellow, G = green
 All technical data are based on manufacturer's specifications.

Fortsetzung nächste Seite

Suite à la prochaine page

Continued on next page

bar=Arbeitsdruck bei +23°C
 B.Radius=min. Biegeradius
 d=Rohraussen-ø
 d1=Rohrinnen-ø
 s=Wandstärke

bar=pression de service à +23°C
 B.Radius=rayon de courbure min.
 d=ø extérieur du tube
 d1=ø intérieur du tube
 s=épaisseur de la paroi

bar=operation pressure at +23°C
 B.Radius=min. bending radius
 d=tube outside diameter
 d1=tube inside diameter
 s=wall thickness

Rohre, Schläuche

Tubes, Tuyaux

Tubes, Hoses

Merkmale:

- breiter Temperatur- und Einsatzbereich
- Farbe schwarz, UV-beständig
- silikonfrei, halogenfrei
- druckbeständig, schlag- und kerbschlagzäh
- glatte und undurchlässige Oberfläche
- Beständigkeitsliste siehe Anhang
- Anwendungen: Druckluft, Hydraulik, Unterdruck, Kühlleitungen, Kraftstoff- und Schmierleitungen

Caractéristiques:

- large plage de température et d'application
- couleur noir, compatible aux UV
- sans silicone, sans halogène
- résistance mécanique aux coups et entailles
- surface lisse
- liste des résistances chimique, voir annexe
- utilisations: conduites d'air comprimé, hydrauliques, de vide, de refroidissement, de carburant et de lubrifiant

Characteristics:

- wide temperature and application range
- colour black, UV resistant
- silicone free, halogen free
- pressure and impact resistant
- smooth surface and impermeable
- chemical resistance list see appendix.
- applications: compressed air, hydraulics, negative pressure, cooling lines, fuel and lubricating lines

KROVAVANZ

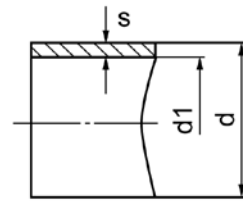
Polyethylen-Rohr (LD-PE)
Tube en polyéthylène (LD-PE)
Polyethylene tube (LD-PE)

LDPE-ROHRE

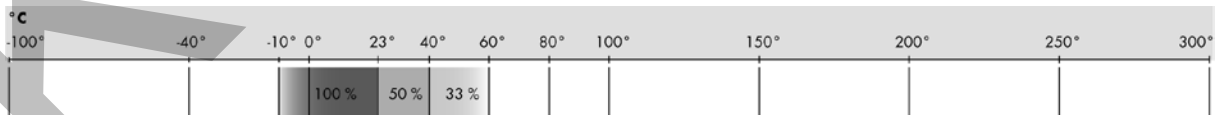
Type d / d1 x s (1)	Mat.-Nr.	bar	d	d1	s	Tol. d	B.Radius	kg/100m
LDPE 4/2x1 W, 100m	420.0100.105	21	4.00	2.00	1.00	±0.20	18	1.180
LDPE 4/2x1 S, 100m	420.0100.205	21	4.00	2.00	1.00	±0.20	18	1.180
LDPE 5/3x1 W, 100m	420.0150.105	14	5.00	3.00	1.00	±0.20	20	1.470
LDPE 5/3x1 S, 100m	420.0150.205	14	5.00	3.00	1.00	±0.20	20	1.470
LDPE 6/4x1 W, 100m	420.0200.105	13	6.00	4.00	1.00	±0.20	30	1.540
LDPE 6/4x1 W, 250m	420.0200.115	13	6.00	4.00	1.00	±0.20	30	1.540
LDPE 6/4x1 S, 100m	420.0200.205	13	6.00	4.00	1.00	±0.20	30	1.540
LDPE 6/4x1 S, 250m	420.0200.215	13	6.00	4.00	1.00	±0.20	30	1.540
LDPE 6/4x1 B, 100m	420.0200.305	13	6.00	4.00	1.00	±0.20	30	1.540
LDPE 6/4x1 B, 250m	420.0200.315	13	6.00	4.00	1.00	±0.20	30	1.540
LDPE 6/4x1 R, 100m	420.0200.405	13	6.00	4.00	1.00	±0.20	30	1.540
LDPE 6/4x1 R, 250m	420.0200.415	13	6.00	4.00	1.00	±0.20	30	1.540
LDPE 6/4x1 Y, 100m	420.0200.505	13	6.00	4.00	1.00	±0.20	30	1.540
LDPE 6/4x1 G, 100m	420.0200.605	13	6.00	4.00	1.00	±0.20	30	1.540
LDPE 6,35/4,35x1 W, 100m	420.0210.105	10	6.35	4.35	1.00	±0.20	30	2.050
LDPE 8/6x1 W, 100m	420.0300.105	9	8.00	6.00	1.00	±0.20	40	2.640
LDPE 8/6x1 S, 100m	420.0300.205	9	8.00	6.00	1.00	±0.20	40	2.640
LDPE 8/6x1 B, 100m	420.0300.305	9	8.00	6.00	1.00	±0.20	40	2.640
LDPE 8/6x1 R, 100m	420.0300.405	9	8.00	6.00	1.00	±0.20	40	2.640
LDPE 8/6x1 Y, 100m	420.0300.505	9	8.00	6.00	1.00	±0.20	40	2.640
LDPE 8/6x1 G, 100m	420.0300.605	9	8.00	6.00	1.00	±0.20	40	2.640
LDPE 9.52/6.52x1.5 W, 100m	420.0315.105	10	9.52	6.52	1.50	±0.20	40	3.000
LDPE 10/8x1 W, 50m	420.0350.105	7	10.00	8.00	1.00	±0.20	60	3.230
LDPE 10/8x1 S, 50m	420.0350.205	7	10.00	8.00	1.00	±0.20	60	3.230
LDPE 10/8x1 B, 50m	420.0350.305	7	10.00	8.00	1.00	±0.20	60	3.230
LDPE 10/8x1 R, 50m	420.0350.405	7	10.00	8.00	1.00	±0.20	60	3.230
LDPE 10/7x1.5 W, 50m	420.0355.105	11	10.00	7.00	1.50	±0.20	40	3.740
LDPE 10/7x1.5 S, 50m	420.0355.205	11	10.00	7.00	1.50	±0.20	40	3.740
LDPE 12/10x1 W, 50m	420.0400.105	6	12.00	10.00	1.00	±0.30	80	4.620
LDPE 12/10x1 S, 50m	420.0400.205	6	12.00	10.00	1.00	±0.30	80	4.620
LDPE 12/9x1.5 W, 50m	420.0405.105	9	12.00	9.00	1.50	±0.30	65	4.620
LDPE 12/9x1.5 S, 50m	420.0405.205	9	12.00	9.00	1.50	±0.30	65	4.620
LDPE 16/13x1.5 W, 50m	420.0500.105	6	16.00	13.00	1.50	±0.20	80	7.000

Druckauswertungsgrad in % des PN
Coefficient de pression en % de PN
Pressure coefficient in % of PN

Fortsetzung nächste Seite

Suite à la prochaine page

Continued on next page

bar=Arbeitsdruck bei +23 °C
 B.Radius=min. Biegeradius
 d=Rohraussen-ø
 d1=Rohrinnen-ø
 s=Wandstärke

bar=pression de service à +23 °C
 B.Radius=rayon de courbure min.
 d=ø extérieur du tube
 d1=ø intérieur du tube
 s=épaisseur de la paroi

bar=operation pressure at +23 °C
 B.Radius=min. bending radius
 d=tube outside diameter
 d1=tube inside diameter
 s=wall thickness

Spezifikationen:

Werkstoff: Polyethylen LD (niedrige Dichte)
 Temperaturbereich: -10°C bis +60°C (kurzfristig: +80°C)
 Brandverhalten: gem. UL 94 HB
 Härte: Shore D45
 Berstdruck: 3-facher Betriebsdruck
 (1) Farben: W = weiss, S = schwarz, B = blau, R = rot, Y = gelb, G = grün
 Alle technischen Daten basieren auf den Herstellerangaben.

Spécifications:

Matériau: Polyéthylène LD (basse densité)
 Plage de température: -10°C à +60°C (à courte terme: +80°C)
 Inflammabilité: selon UL 94 HB
 Dureté: Shore D45
 Pression d'éclatement: 3 x pression de service
 (1) Couleurs: W = blanc, S = noir, B = bleu, R = rouge, Y = jaune, G = vert
 Tous les données techniques reposent sur les indications du fabricant.

Specifications:

Material: Polyethylene LD (low density)
 Temperature range: -10°C to +60°C (short-term: +80°C)
 Flammability: acc. to UL 94 HB
 Hardness: Shore D45
 Burst pressure: 3 x working pressure
 (1) Colours: W = white, S = black, B = blue, R = red, Y = yellow, G = green
 All technical data are based on manufacturer's specifications.

Merkmale:

- gute Flexibilität, schlagfest
- Farbe schwarz UV-beständig
- silikonfrei, halogenfrei
- physiologisch unbedenklich
- Beständigkeitsliste siehe Anhang
- Anwendungen: Druckluftleitungen für Regeltechnik, Probenahmeleitungen, flexible Pneumatikleitungen im unteren Druckbereich, Umgebungen mit hohem Feuchtigkeitsgrad

Caractéristiques:

- bonne flexibilité, résistant aux coups
- couleur noire compatible UV
- sans silicone, sans halogène
- physiologiquement sans risques
- liste des résistances chimiques, voir annexe
- utilisations: tuyauteries pour air comprimé en applications de régulations, conduits de prélèvements pour tests, flexibles pneumatiques pour basses pressions, environnements à hygrométrie élevée

Characteristics:

- good flexibility, impact resistant
- colour black UV-resistant
- silicone free, halogen free
- non-toxic
- chemical resistance list see appendix
- applications: compressed air for control technology, sampling lines, flexible pneumatic lines in low pressure range, environments with high humidity

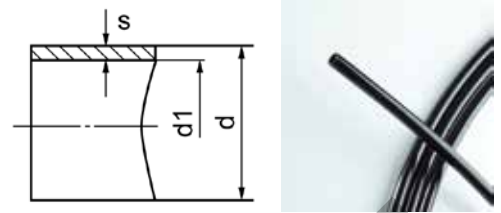
Polyurethan-Rohr (PU)
Tube en polyuréthane (PU)
Polyurethane tube (PU)

PU-ROHRE

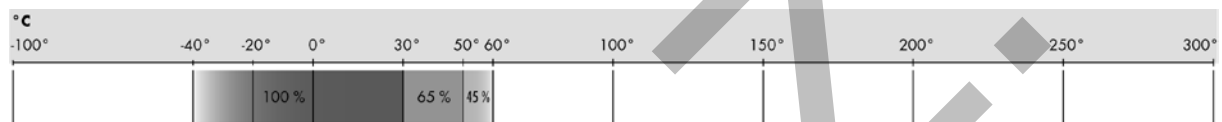
Type d / d1 x s (1)	Mat.-Nr.	bar	d	d1	s	Tol. d	B.Radius	kg/100m
PU 6/4x1 S, 100m	424.0200.205	13	6.00	4.00	1.00	±0.10	20	2.000
PU 6/4x1 B, 100m	424.0200.305	13	6.00	4.00	1.00	±0.10	20	2.000
PU 8/6x1 S, 100m	424.0300.205	10	8.00	6.00	1.00	±0.10	25	3.400
PU 8/6x1 B, 100m	424.0300.305	10	8.00	6.00	1.00	±0.10	25	3.400
PU 10/8x1 S, 100m	424.0350.205	7	10.00	8.00	1.00	±0.15	35	5.200
PU 10/8x1 B, 100m	424.0350.305	7	10.00	8.00	1.00	±0.15	35	5.200

Druckauswertungsgrad in % des PN
Coefficient de pression en % de PN
Pressure coefficient in % of PN

Spezifikationen:

Werkstoff: Polyurethan
 Temperaturbereich: -40°C bis +60°C (kurzfristig: +80°C)
 Brandverhalten: gem. UL 94 HB
 Härte: Shore D52
 Berstdruck: 3-facher Betriebsdruck
 (1) Farben: S = schwarz, B = blau
 Alle technischen Daten basieren auf den Herstellerangaben.

Spécifications:

Matériau: Polyuréthane
 Plage de température: -40°C à +60°C (à courte terme: +80°C)
 Inflammabilité: selon UL 94 HB
 Dureté: Shore D52
 Pression d'éclatement: 3 x pression de service
 (1) Couleurs: S = noir, B = bleu
 Tous les données techniques reposent sur les indications du fabricant.

Specifications:

Material: Polyurethane
 Temperature range: -40°C to +60°C (short-term: +80°C)
 Flammability: acc. to UL 94 HB
 Hardness: Shore D52
 Burst pressure: 3 x working pressure
 (1) Colors: S = black, B = blue
 All technical data are based on manufacturer's specifications.

Merkmale:

- hervorragende Biegefähigkeit, hohe Kälteflexibilität
- geringe Verformung auch bei Langzeitbelastung
- silikonfrei, halogenfrei
- abriebfest
- Farbe schwarz UV-beständig
- Beständigkeitsliste siehe Anhang
- Anwendungen: Mess- und Regeltechnik, Pneumatik, Hydraulik, Maschinen- und Motorenbau, Kraftstoff- und Schmierleitungen

Caractéristiques:

- très flexible, haute flexibilité à froid
- faible déformation même en cas de charge de longue durée
- sans silicone, sans halogène
- résiste au frottement
- couleur noir résistant aux UV
- liste des résistances chimiques, voir annexe
- utilisations: appareillage de mesures et de régulation, pneumatique, hydraulique, construction de machines et de moteurs, conduites de carburant et de lubrification

Characteristics:

- excellent bending, high cold flexibility
- little deformation even with long-term stress
- silicone free, halogen free
- abrasion resistant
- colour black UV-resistant
- chemical resistance list see appendix
- applications: measurement and control technology, pneumatics, hydraulics, machine and motor engineering, fuel and lubricating lines

bar=Arbeitsdruck bei +23°C
 B.Radius=min. Biegeradius
 d=Rohraussen-ø
 d1=Rohrinnen-ø
 s=Wandstärke

bar=pression de service à +23°C
 B.Radius=rayon de courbure min.
 d=ø extérieur du tube
 d1=ø intérieur du tube
 s=épaisseur de la paroi

bar=operation pressure at +23°C
 B.Radius=min. bending radius
 d=tube outside diameter
 d1=tube inside diameter
 s=wall thickness

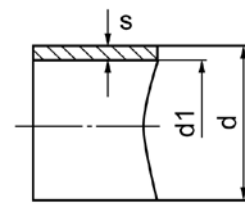
Polytetrafluorethylen-Rohr (PTFE)
Tube en polytétrafluorure d'éthylène (PTFE)
Polytetrafluorethylene tube (PTFE)

PTFE-ROHRE

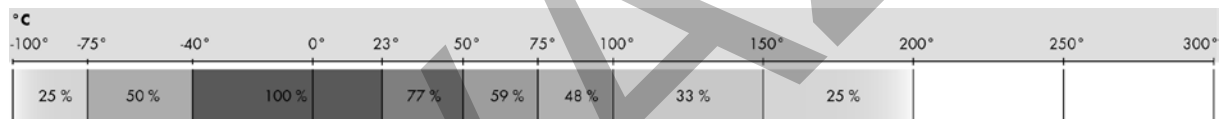
Type d / d1 x s	Mat.-Nr.	bar	d	d1	s	Tol. d	B.Radius	kg/100m
PTFE 2/1x0,5, 50m	431.0040.000	46	2.00	1.00	0.50	±0.10	8	1.200
PTFE 3/2x0,5, 50m	431.0050.000	23	3.00	2.00	0.50	±0.10	12	1.520
PTFE 4/2x1, 50m	431.0100.000	46	4.00	2.00	1.00	±0.10	12	2.100
PTFE 5/3x1, 50m	431.0150.000	31	5.00	3.00	1.00	±0.15	15	2.900
PTFE 6/4x1, 50m	431.0200.000	23	6.00	4.00	1.00	±0.15	20	3.700
PTFE 6/4x1, 100m	431.0200.010	23	6.00	4.00	1.00	±0.15	20	3.700
PTFE 8/6x1, 50m	431.0300.000	15	8.00	6.00	1.00	±0.15	40	5.120
PTFE 8/6x1, 100m	431.0300.010	15	8.00	6.00	1.00	±0.15	40	5.120
PTFE 10/8x1, 50m	431.0350.000	11	10.00	8.00	1.00	±0.20	55	5.760
PTFE 10/7x1,5, 50m	431.0355.000	20	10.00	7.00	1.50	±0.20	50	8.800
PTFE 12/10x1, 50m	431.0400.000	9	12.00	10.00	1.00	±0.20	90	7.360
PTFE 12/9x1,5, 50m	431.0405.000	15	12.00	9.00	1.50	±0.20	60	11.040
PTFE 16/13x1,5, 50m	431.0605.000	10	16.00	13.00	1.50	±0.25	100	14.700

Druckauswertungsgrad in % des PN
Coefficient de pression en % de PN
Pressure coefficient in % of PN

Spezifikationen:

Werkstoff: Polytetrafluorethylen, FDA-konform
 Temperaturbereich: -200°C bis +200°C
 (kurzfristig: +260°C)
 Brandverhalten: gem. UL 94 V0
 Härte: Shore D55
 Berstdruck: 3-facher Betriebsdruck
 Farbe: natur
 Alle technischen Daten basieren auf den Herstellerangaben.

Spécifications:

Matériau: Polytétrafluorure d'éthylène, conformité FDA
 Plage de température: -200°C à +200°C (à courte terme: +260°C)
 Inflammabilité: selon UL 94 V0
 Dureté: Shore D55
 Pression d'éclatement: 3 x pression de service
 Couleur: naturelle
 Tous les données techniques reposent sur les indications du fabricant.

Specifications:

Material: Polytetrafluoroethylene, FDA approved
 Temperature range: -200°C to +200°C (short-term: +260°C)
 Flammability: acc. to UL 94 V0
 Hardness: Shore D55
 Burst pressure: 3 x working pressure
 Colour: natural
 All technical data are based on manufacturer's specifications.

Merkmale:

- gute Temperaturbeständigkeit
- physiologisch unbedenklich
- nicht leitfähig
- hohe Festigkeit, Steifheit, Zähigkeit, sehr flexibel
- UV- und witterungsbeständig, silikonfrei
- ausgezeichnete Antihafteigenschaften
- nicht geeignet für Druckpulsation
- Empfehlung: FEP, PFA oder Jacoflon verwenden
- universelle chemische Beständigkeit; Beständigkeitsliste siehe Anhang
- Anwendungen: Labor, Medizin, Chemie, Analysetechnik, Vakuum

Caractéristiques:

- bonne résistance à la température
- physiologiquement neutre
- non conducteur
- résistance mécanique, rigidité et ténacité élevées, grande flexibilité
- résistance aux intempéries et UV, sans silicone
- excellentes propriétés antiadhésives
- ne convient pas pour les pulsations de pression
- recommandation: utiliser FEP, PFA ou Jacoflon
- résistance chimiques universelle; list des résistances chimiques voir annexe
- utilisations: laboratoire, medical, chimie, techniques d'analyses, vide

Characteristics:

- good temperature resistance
- non-toxic
- non-conductive
- high strength, rigidity, toughness and very good flexibility
- UV and weather resistant, silicone free
- outstanding non-stick properties
- not suitable for pressure pulsation
- recommendation: use FEP, PFA or Jacoflon
- universal chemical resistance; chemical resistance list see appendix
- applications: laboratory, medicine, chemical engineering, analysis technology, vacuum

bar=Arbeitsdruck bei +23°C
 B.Radius=min. Biegeradius
 d=Rohraussen-ø
 d1=Rohrinnen-ø
 s=Wandstärke

bar=pression de service à +23°C
 B.Radius=rayon de courbure min.
 d=ø extérieur du tube
 d1=ø intérieur du tube
 s=épaisseur de la paroi

bar=operation pressure at +23°C
 B.Radius=min. bending radius
 d=tube outside diameter
 d1=tube inside diameter
 s=wall thickness

Polyvinylidenfluorid-Rohr (PVDF)

Tube en polyfluorure de vinylidène (PVDF)

Polyvinylide fluoride tube (PVDF)

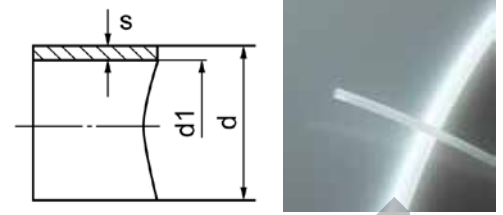

PVDF-ROHRE

Type d / d1 x s	Mat.-Nr.	bar	d	d1	s	Tol. d	B.Radius	kg/100m
PVDF 6/4x1, 50m FDA	430.0200.003	36	6.00	4.00	1.00	±0.10	70	2.800
PVDF 8/6x1, 50m FDA	430.0300.003	24	8.00	6.00	1.00	±0.12	130	3.850
PVDF 10/8x1, 50m FDA	430.0350.003	18	10.00	8.00	1.00	±0.15	200	5.000
PVDF 12/10x1, 50m FDA	430.0400.003	15	12.00	10.00	1.00	±0.20	293	6.000
PVDF 12/9x1.5, 50m FDA	430.0405.003	24	12.00	9.00	1.50	±0.20	200	8.200
PVDF 16/13x1.5, 50m FDA	430.0605.003	16	16.00	13.00	1.50	±0.25	375	9.500

Druckauswertungsgrad in % des PN

Coefficient de pression en % de PN

Pressure coefficient in % of PN

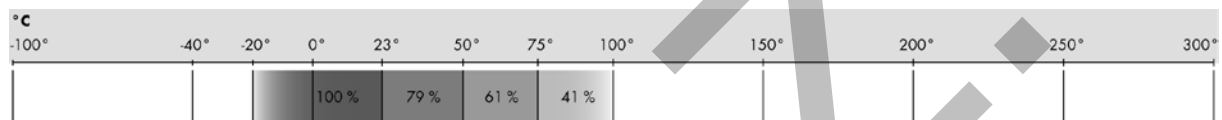

Spezifikationen:

Werkstoff: Polyvinylidenfluorid, FDA-konform
 Temperaturbereich: -20°C bis +100°C (kurzfristig: +130°C)
 Brandverhalten: gem. UL 94 V0
 Härte: Shore D78
 Berstdruck: 3-facher Betriebsdruck
 Farbe: natur
 Alle technischen Daten basieren auf den Herstellerangaben.

Spécifications:

Matériau: Polyfluorure de vinylidène, conformité FDA
 Plage de température: -20°C à +100°C (à courte terme: +130°C)
 Inflammabilité: selon UL 94 V0
 Dureté: Shore D78
 Pression d'éclatement: 3 x pression de service
 Couleur: naturelle
 Tous les données techniques reposent sur les indications du fabricant.

Specifications:

Material: Polyvinylide fluoride, FDA approved
 Temperature range: -20°C to +100°C (short-term: +130°C)
 Flammability: acc. to UL 94 V0
 Hardness: Shore D78
 Burst pressure: 3 x working pressure
 Colour: natural
 All technical data are based on manufacturer's specifications.

Merkmale:

- molekularer, teilkristalliner Thermoplast
- hervorragende Kombination von Festigkeit, Zähigkeit, Abriebfestigkeit
- enorme Spannungsris- und Chemikalienbeständigkeit
- physiologisch unbedenklich, sterilisierbar
- silikonfrei
- UV- und witterungsbeständig
- verschweißbar
- Beständigkeitsliste siehe Anhang
- Anwendungen: Medizin, Chemie, Analysetechnik, Nahrungsmittelindustrie

Caractéristiques:

- thermoplastique à structure moléculaire cristalline partielle
- combinaison avantageuse de flexibilité, de solidité, de résistance au frottement et à l'arrachement
- remarquable résistance au fendilles par contrainte et chimique
- physiologiquement neutre, stérilisable
- sans silicone
- résistance aux intempéries et UV
- soudable
- liste des résistances chimiques, voir annexe
- utilisations: médical, chimie, techniques d'analyses, industrie alimentaire

Characteristics:

- molecular, partially crystalline thermoplastic
- excellent combination of stability, strength, abrasion resistance
- excellent stress crack and chemical resistance
- non-toxic, sterilisable
- silicone free
- UV and weather resistant
- weldable
- chemical resistance list see appendix
- applications: medicine, chemical engineering, analysis technology, food industry

bar=Arbeitsdruck bei +23°C
 B.Radius=min. Biegeradius
 d=Rohraussen-ø
 d1=Rohrinnen-ø
 s=Wandstärke

bar=pression de service à +23°C
 B.Radius=rayon de courbure min.
 d=ø extérieur du tube
 d1=ø intérieur du tube
 s=épaisseur de la paroi

bar=operation pressure at +23°C
 B.Radius=min. bending radius
 d=tube outside diameter
 d1=tube inside diameter
 s=wall thickness

Perfluorethylenpropylen-Rohr (FEP)

Tube en fluoréthylène propylène (FEP)

Fluorinated ethylene propylene tube (FEP)

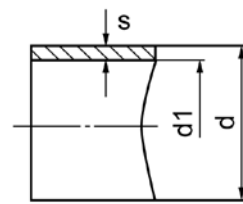

FEP-ROHRE

Type d / d1 x s	Mat.-Nr.	bar	d	d1	s	Tol. d	B.Radius	kg/100m
FEP 4/2.5x0.75, 50m	432.0095.005	22	4.00	2.50	0.75	±0.10	20	1.700
FEP 4/2x1, 50m	432.0100.003	37	4.00	2.00	1.00	±0.10	15	2.100
FEP 6/4x1, 50m	432.0200.003	18	6.00	4.00	1.00	±0.15	30	3.550
FEP 6/3x1.5, 50m	432.0205.003	37	6.00	3.00	1.50	±0.15	25	4.600
FEP 8/6x1, 50m	432.0300.003	12	8.00	6.00	1.00	±0.15	55	4.850
FEP 10/8x1, 50m	432.0350.003	9	10.00	8.00	1.00	±0.20	90	5.800
FEP 12/10x1, 50m	432.0400.003	8	12.00	10.00	1.00	±0.20	135	7.430
FEP 12/9x1,5, 50m	432.0405.003	13	12.00	9.00	1.50	±0.20	95	10.640

Druckauswertungsgrad in % des PN

Coefficient de pression en % de PN

Pressure coefficient in % of PN

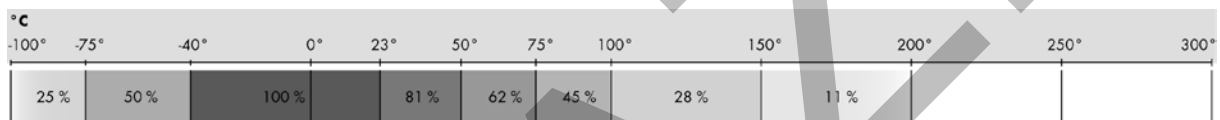

Spezifikationen:

Werkstoff: Perfluorethylenpropylen, FDA-konform
 Temperaturbereich: -200°C bis +200°C
 Brandverhalten: gem. UL 94 V0
 Härte: Shore D55
 Berstdruck: 3-facher Betriebsdruck
 Farbe: natur
 Alle technischen Daten basieren auf den Herstellerangaben.

Spécifications:

Matériau: Perfluorethylenpropylen, conformité FDA
 Plage de température: -200°C à +200°C
 Inflammabilité: selon UL 94 V0
 Dureté: Shore D55
 Pression d'éclatement: 3 x pression de service
 Couleur: naturelle
 Tous les données techniques reposent sur les indications du fabricant.

Specifications:

Material: Fluorinated ethylene propylene, FDA approved
 Temperature range: -200°C to +200°C
 Flammability: acc. to UL 94 V0
 Hardness: Shore D55
 Burst pressure: 3 x working pressure
 Colour: natural
 All technical data are based on manufacturer's specifications.

Merkmale:

- gute Temperaturbeständigkeit
- gute Antihafteigenschaften, silikonfrei, sterilisierbar
- elastischer als PTFE
- geringe Permeabilität
- dielektrische Eigenschaften, nicht leitfähig
- UV- und witterungsbeständig
- beständig gegen Sauerstoff und Ozon; Beständigkeitsliste siehe Anhang
- Anwendungen: Pharma, Labor, Medizin, Lebensmittelindustrie, Halbleitertechnik

Caractéristiques:

- bonne résistance à la température
- bonnes propriétés antiadhésives, sans silicone, stérilisable
- plus élastique que le PTFE
- faible perméabilité
- propriétés diélectriques, non conducteur
- résistance aux intempéries et UV
- résistant à l'oxygène et à l'ozone; liste des résistances chimiques, voir annexe
- utilisations: pharmacie, laboratoire, médecine, industrie alimentaire, technologie des semi-conducteurs

Characteristics:

- good temperature resistance
- good non-stick properties, silicone-free, sterilisable
- higher elasticity than PTFE
- low permeability
- dielectric properties, non-conductive
- UV and weather resistant
- resistant to oxygen and ozone; chemical resistance list see appendix
- applications: pharmaceuticals, laboratory, medicine, food industry, semiconductor technology

bar=Arbeitsdruck bei +23°C
 B.Radius=min. Biegeradius
 d=Rohraussen-ø
 d1=Rohrinnen-ø
 s=Wandstärke

bar=pression de service à +23°C
 B.Radius=rayon de courbure min.
 d=ø extérieur du tube
 d1=ø intérieur du tube
 s=épaisseur de la paroi

bar=operation pressure at +23°C
 B.Radius=min. bending radius
 d=tube outside diameter
 d1=tube inside diameter
 s=wall thickness

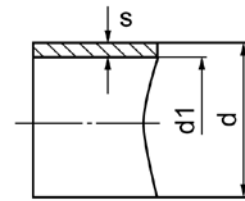
Perfluoralkoxy-Rohr (PFA)
Tube en perfluoralkoxy (PFA)
Perfluoroalkoxy tube (PFA)

PFA-ROHRE

Type d / d1 x s	Mat.-Nr.	bar	d	d1	s	Tol. d	B.Radius	kg/100m
PFA 6/4x1, 100m	436.0200.003	23	6.00	4.00	1.00	± 0.15	30	3.370
PFA 6/3x1.5, 100m	436.0205.003	46	6.00	3.00	1.50	± 0.15	25	4.680
PFA 8/6x1, 100m	436.0300.003	15	8.00	6.00	1.00	± 0.15	55	4.730

Druckauswertungsgrad in % des PN
Coefficient de pression en % de PN
Pressure coefficient in % of PN

°C												
-100°	-75°	-40°	0°	23°	50°	75°	100°	150°	200°	250°	300°	
25 %	50 %	100 %	86 %	61 %	50 %	36 %	25 %					

Spezifikationen:

Werkstoff: Perfluoralkoxy, FDA-konform
 Temperaturbereich: -200°C bis +200°C
 (kurzfristig: bis +260°C)
 Brandverhalten: gem. UL 94 V0
 Härte: Shore D60
 Berstdruck: 3-facher Betriebsdruck
 Farbe: natur
 Alle technischen Daten basieren auf den
 Herstellerangaben.

Spécifications:

Matériau: Perfluoralkoxy, conformité FDA
 Plage de température: -200°C à +200°C
 (à courte terme: +260°C)
 Inflammabilité: selon UL 94 V0
 Dureté: Shore D60
 Pression d'éclatement: 3 x pression de service
 Couleur: naturelle
 Tous les données techniques reposent sur les
 indications du fabricant.

Specifications:

Material: Perfluoroalkoxy, FDA approved
 Temperature range: -200°C to +200°C
 (short term: +260°C)
 Flammability: acc. to UL 94 V0
 Hardness: Shore D60
 Burst pressure: 3 x working pressure
 Colour: natural
 All technical data are based on
 manufacturer's specifications.

Merkmale:

- gute Temperaturbeständigkeit
- gute Antihafteigenschaften, silikonfrei, sterilisierbar
- elastischer als PTFE
- geringe Permeabilität
- dielektrische Eigenschaften, nicht leitfähig
- UV- und witterungsbeständig
- beständig gegen Sauerstoff und Ozon;
Beständigkeitsliste siehe Anhang
- Anwendungen: Pharma, Labor, Medizin,
Lebensmittelindustrie, Halbleitertechnik

Caractéristiques:

- bonne résistance à la température
- bonnes propriétés antiadhésives, sans silicone, stérilisable
- plus élastique que le PTFE
- faible perméabilité
- propriétés diélectriques, non conducteur
- résistance aux intempéries et UV
- résistant à l'oxygène et à l'ozone;
liste des résistances chimiques, voir annexe
- utilisations: pharmacie, laboratoire, médecine,
industrie alimentaire, technologie des semi-conducteurs

Characteristics:

- good temperature resistance
- good non-stick properties, silicone-free, sterilizable
- higher elasticity than PTFE
- low permeability
- dielectric properties, non-conductive
- UV and weather resistant
- resistant to oxygen and ozone;
chemical resistance list see appendix
- applications: pharmaceuticals, laboratory, medicine, food industry, semiconductor technology

bar=Arbeitsdruck bei +23°C
 B.Radius=min. Biegeradius
 d=Rohraussen-ø
 d1=Rohrinnen-ø
 s=Wandstärke

bar=pression de service à +23°C
 B.Radius=rayon de courbure min.
 d=ø extérieur du tube
 d1=ø intérieur du tube
 s=épaisseur de la paroi

bar=operation pressure at +23°C
 B.Radius=min. bending radius
 d=tube outside diameter
 d1=tube inside diameter
 s=wall thickness

SERTOflex-Rohr

Tube SERTOflex

SERTOflex tube

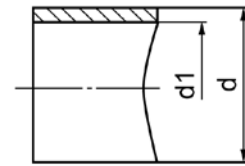

SERTO FLEX

Type	Mat.-Nr.	bar	d	d1	B.Radius	kg/100m
SERTOflex 6 S, 100m	440.1006.210	30	6.00	4.00	19	2.400
SERTOflex 6.35 S, 300m	440.1007.215	30	6.35	4.30	19	2.400
SERTOflex 8 S, 100m	440.1008.210	30	8.00	5.30	25	3.900
SERTOflex 10 S, 100m	440.1010.210	30	10.00	6.20	32	5.800
SERTOflex 12 S, 100m	440.1012.210	25	12.00	8.10	40	7.500
SERTOflex 14 S, 100m	440.1014.210	25	14.00	9.80	50	9.600
SERTOflex 15 S, 100m	440.1015.210	20	15.00	10.70	50	10.200

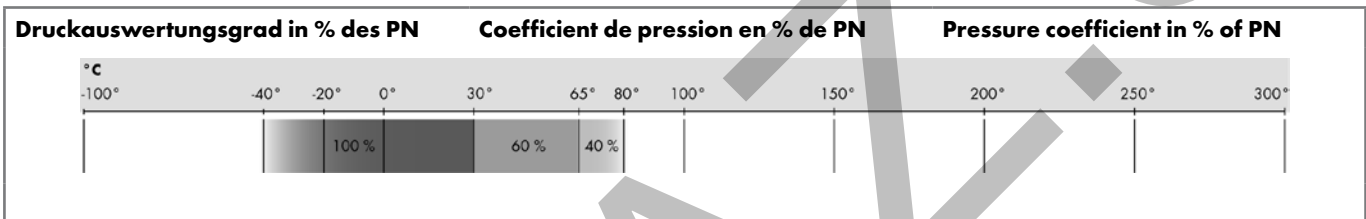

Spezifikationen:	Spécifications:	Specifications:
Temperaturbereich: -40°C bis +80°C Farbe: schwarz Berstdruck: 3-facher Betriebsdruck Toleranz AD: +0.20/-0.35 mm Alle technischen Daten basieren auf den Herstellerangaben.	Plage de température: -40°C à +80°C Couleur: noir Pression d'éclatement: 3 x pression de service Tolérance Ø extérieur: +0.20/-0.35 mm Tous les données techniques reposent sur les indications du fabricant.	Temperature range: -40°C to +80°C Colour: black Burst pressure: 3 x working pressure Tolerance outside Ø: +0.20/-0.35 mm All technical data are based on manufacturer's specifications.
Kalibrierwerkzeug zu SERTOflex: siehe Kapitel Zubehör, Werkzeuge	Outil de calibrage pour SERTOflex: voir chapitre Accessoires, Outillages	Calibration tool for SERTOflex: see chapter Accessories, Tools

Merkmale:	Caractéristiques:	Characteristics:
<ul style="list-style-type: none"> - Mehrschichtrohr aus PE und Aluminium-Einlage - von Hand verformbar - formstabil, halogen- und silikonfrei - geringes Gewicht bei hoher Stabilität - Anwendungen: ausschliesslich für pneumatische Steuer- und Prozessleitungen, vor allem in feuchter und nasser Umgebung 	<ul style="list-style-type: none"> - tube multi-couche en PE et insert en aluminium - façonnable à la main - indéformable, sans halogènes, sans silicone - faible poids et haute stabilité - utilisation: uniquement pour les conduites de commande et d'asservissement, essentiellement en ambiance humid 	<ul style="list-style-type: none"> - multilayer tube of PE and aluminium core - can be bent manually - stable in form, halogen and silicone free - lightweight with high stability - applications: exclusively for pneumatic control and process lines, especially in humid and wet environment

1	2	3	4
1 Innere Beschichtung: PE 2 Einlage: Aluminium 3 Film: PE 4 Mantel: HD-PE	1 Revêtement intérieur: PE 2 Ame: aluminium 3 Pellicule: PE 4 Revêtement extérieur: PE-HD	1 Internal coating: PE 2 Inlay: aluminium 3 Film: PE 4 Jacket: HD-PE	

bar=Arbeitsdruck bei +23°C
 B.Radius=min. Biegeradius
 d=Rohraussen-ø
 d1=Rohrinnen-ø
 s=Wandstärke

bar=pression de service à +23°C
 B.Radius=rayon de courbure min.
 d=ø extérieur du tube
 d1=ø intérieur du tube
 s=épaisseur de la paroi

bar=operation pressure at +23°C
 B.Radius=min. bending radius
 d=tube outside diameter
 d1=tube inside diameter
 s=wall thickness

Präzisionsrohre aus Edelstahl 1.4301

Tubes de précision en acier inoxydable 1.4301

Stainless steel tubes 1.4301

INOX 1.4301

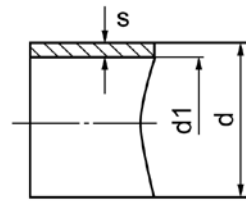

Type d / d1 x s	Mat.-Nr.	bar	d	d1	s	kg/m
Inox-Rohr 6/4x1 (1.4301) 6m	451.1006.200	530	6.00	4.00	1.00	0.130
Inox-Rohr 8/6x1 (1.4301) 6m	451.1006.300	380	8.00	6.00	1.00	0.180
Inox-Rohr 10/8x1 (1.4301) 6m	451.1006.350	290	10.00	8.00	1.00	0.260

Druckauswertungsgrad in % des PN				Coefficient de pression en % de PN			Pressure coefficient in % of PN			
°C										
-196*	-110*	-60*	0*	300*	400*	450*	500*	600*		
50 %	70 %			100 %	75 %	60 %	50 %		auf Anfrage sur demande on request	

Spezifikationen:

Werkstoff: 1.4301 (= AISI 304)
 Temperaturbereich: -196°C bis +500°C (bis +600°C auf Anfrage)
 Berstdruck: 4-facher Betriebsdruck bei ruhender Belastung
 Abmessungen und Toleranzen: siehe Kapitel i

Spécifications:

Matériau: 1.4301 (= AISI 304)
 Plage de température: -196°C à +500°C (jusqu'à +600°C sur demande)
 Pression d'éclatement: 4 x pression de service sous charge statique
 Dimensions et tolérances: voir chapitre i

Specifications:

Material: 1.4301 (= AISI 304)
 Temperature range: -196°C to +500°C (up to +600°C on request)
 Burst pressure: 4 times working pressure under static load
 Dimensions and tolerances: see chapter i

Merkmale:

- nahtlos, kalt gefertigt, blankgeglüht, Lieferzustand CFA, nach EN 10305-1 / EN 10216-5 / EN ISO 1127
- speziell auf unsere Verschraubungen abgestimmt
- Bescheinigungen über Werkstoffprüfungen nach DIN EN 10204 können abgegeben werden

Caractéristiques:

- sans soudure, fabriqué à froid, recuit blanc, état de livraison CFA, selon EN 10305-1 / EN 10216-5 / EN ISO 1127
- spécialement adaptés à nos raccords
- attestations d'essai des matériaux utilisés selon DIN EN 10204 délivrables sur demande

Characteristics:

- seamless, cold finished, bright, annealed, state of delivery CFA, accord. to EN 10305-1 / EN 10216-5 / EN ISO 1127
- especially adapted to our unions
- material test certificates according to DIN EN 10204 can be provided upon request

Präzisionsrohre aus Edelstahl 1.4571

Tubes de précision en acier inoxydable 1.4571

Stainless steel tubes 1.4571

INOX 1.4571

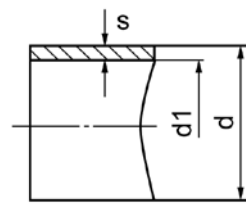

Type d / d1 x s	Mat.-Nr.	bar	d	d1	s	kg/m
Inox-Rohr 6/4x1 (1.4571) 6m	450.1006.200	530	6.00	4.00	1.00	0.130
Inox-Rohr 8/6x1 (1.4571) 6m	450.1006.300	380	8.00	6.00	1.00	0.180
Inox-Rohr 10/7x1,5 (1.4571) 6m	450.1006.355	490	10.00	7.00	1.50	0.319
Inox-Rohr 10/8x1 (1.4571) 6m	450.1006.350	290	10.00	8.00	1.00	0.260
Inox-Rohr 12/10x1 (1.4571) 6m	450.1006.401	250	12.00	10.00	1.00	0.280
Inox-Rohr 12/9x1,5 (1.4571) 6m	450.1006.405	370	12.00	9.00	1.50	0.390
Inox-Rohr 15/13x1 (1.4571) 6m	450.1006.550	200	15.00	13.00	1.00	0.350
Inox-Rohr 15/12x1,5 (1.4571) 6m	450.1006.555	270	15.00	12.00	1.50	0.500
Inox-Rohr 18/15x1,5 (1.4571) 6m	450.1006.705	240	18.00	15.00	1.50	0.620

Druckauswertungsgrad in % des PN				Coefficient de pression en % de PN			Pressure coefficient in % of PN			
°C										
-196°	-110°	-60°	0°	300°			400°	450°	500°	600°
50%	70%			100%			75%	60%	50%	auf Anfrage sur demande on request

Spezifikationen:	Spécifications:	Specifications:
Werkstoff: 1.4571 (≈ AISI 316Ti)	Matériau: 1.4571 (≈ AISI 316Ti)	Material: 1.4571 (≈ AISI 316Ti)
Temperaturbereich: -196°C bis +500°C (bis +600°C auf Anfrage)	Plage de température: -196° à +500°C (jusqu'à +600°C sur demande)	Temperature range: -196° to +500°C (up to +600°C on request)
Berstdruck: 4-facher Betriebsdruck bei ruhender Belastung	Pression d'éclatement: 4 x pression de service sous charge statique	Burst pressure: 4 times working pressure under static load
Abmessungen und Toleranzen: siehe Kapitel i	Dimensions et tolérances: voir chapitre i	Dimensions and tolerances: see chapter i

Merkmale:	Caractéristiques:	Characteristics:
- nahtlos, kalt gefertigt, blankgeglüht, Lieferzustand CFA, nach EN 10305-1 / EN 10216-5 / EN ISO 1127	- sans soudure, fabriqué à froid, recuit blanc, état de livraison CFA, selon EN 10305-1 / EN 10216-5 / EN ISO 1127	- seamless, cold finished, bright, annealed, state of delivery CFA, accord. to EN 10305-1 / EN 10216-5 / EN ISO 1127
- speziell auf unsere Verschraubungen abgestimmt	- spécialement adaptés à nos raccords	- especially adapted to our unions
- Bescheinigungen über Werkstoffprüfungen nach DIN EN 10204 können abgegeben werden	- attestations d'essai des matériaux utilisés selon DIN EN 10204 délivrables sur demande	- material test certificates according to DIN EN 10204 can be provided upon request

bar=Arbeitsdruck bei +23°C
 d=Rohr außen-Ø
 d1=Rohr innen-Ø
 s=Wandstärke

bar=pression de service à +23°C
 d=Ø extérieur du tube
 d1=Ø intérieur du tube
 s=épaisseur de la paroi

bar=operation pressure at +23°C
 d=tube outside diameter
 d1=tube inside diameter
 s=wall thickness

Jacoflon edelstahldrahtumflochtene PTFE-Schläuche
Jacoflon tuyau en PTFE avec tressage en acier inoxydable
Jacoflon PTFE hoses with stainless steel braid

Technische Daten

Die Flexibilität sowie die Korrosions- und Druckbeständigkeit machen den Jacoflon PTFE-Schlauch zu einem Schlauch für besondere Anwendungen. Lieferbar sind Schläuche mit Armaturen aus Edelstahl 1.4571 in unterschiedlichen Längen und Ausführungen nach Kundenspezifikation.

Données techniques

La flexibilité ainsi que la résistance à la corrosion et à la pression du tube Jacoflon PTFE le rend idéal pour des applications spéciales. Les tuyaux avec raccords en acier inoxydable 1.4571 sont livrables dans des longueurs et des exécutions les plus variées et selon spécifications du client.

Technical data

Due to its flexibility and the excellent corrosion and pressure resistance the Jacoflon PTFE hose is ideally suited for special applications. The hoses with stainless steel fittings 1.4571 are available in different lengths and designs according to customer specifications .

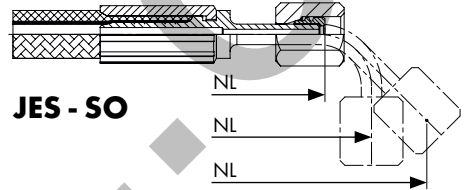
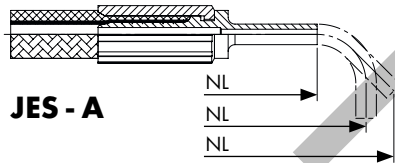
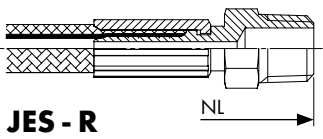

NL = Nennlänge des Schlauches gemäss Massbild

NL = Longueur nominale du tuyau selon plan coté
 NL = Nominal length of tube as per drawing

Bestellbeispiel	Exemple pour commande	Ordering example
	1 AQ 1/8 - R 1/8 - A3 x 450	
Schlauchtyp Type de tuyau Tube type	1. Anschluss 1. Raccord 1. Fitting	2. Anschluss 2. Raccord 2. Fitting
		Schlauchnennlänge mm Longeur nominale du tuyau mm Nominal length of tube mm

Spezifikationen	Spécifications	Specifications
Werkstoff: Innenschlauch PTFE, Drahtgeflecht 1.4301 Temperaturbereich: -60°C bis +250°C	Matériau: tuyau intérieur PTFE, tresse en fil 1.4301 Plage de température: -60°C à +250°C	Material: internal hose PTFE, wire braid 1.4301 Temperature range: -60°C to +250°C

Schlauch-Längentoleranz in mm	Tolérances du longueur du tuyau mm	Tolerances for tube length mm						
mm	0	500	1'000	2'000	3'000	5'000	10'000	20'000
	+5 / -3 mm	+10 / -5 mm	+20 / -10 mm	+70 / -15 mm	+80 / -20 mm	+100 / -30 mm	+150 / -40 mm	

Merkmale

- hohe chemische Beständigkeit
- thermische Stabilität
- absolut ungiftig
- sehr grosse Betriebssicherheit
- lange Lebensdauer
- Anwendungen: Heissdampf, Wasch- und Reinigungsanlagen, Vulkanisierpressen, Hochleistungsölbrenner, Labor- und Medizintechnik, Raumfahrt und Lebensmittelindustrie

Caractéristiques

- bonne résistance chimique
- stabilité thermique
- aucune toxicité
- sécurité de fonctionnement très haute
- longévité
- Applications: Installations de vapeur chaude, stations de lavage, presses de vulcanisation, brûleurs à haute capacité, secteur des laboratoires et médical, industrie alimentaire

Features

- high chemical resistance
- thermal stability
- non-toxic
- high operating safety
- longevity
- Applications: Superheated steam installations, wash- and cleaning stations, vulcanising presses, high-power burners, in laboratories or pharmaceutical labs, foodstuff industry

Druckauswertungsgrad in % des PN

Coefficient de pression en % de PN

Pressure coefficient % of PN

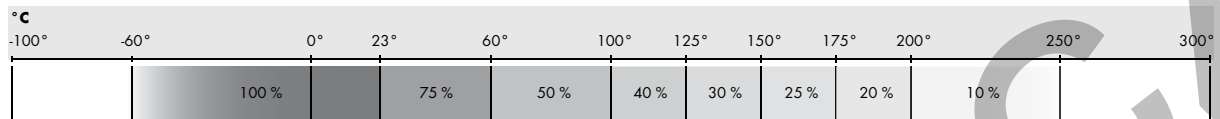

Einbaurichtlinien für Schlauchleitungen

Schlauchleitungen sind so anzuordnen, dass sie leicht eingebaut und kontrolliert werden können; ein Scheuern an anderen Bauteilen ist zu vermeiden. Die angegebenen Mindestbiegeradien sind unbedingt einzuhalten. Bei häufiger Bewegung sind sie zur Verbesserung der Lebensdauer des Schlauches bis zu 50 % zu vergrössern. Jede gerade Schlauchleitung ist grundsätzlich mit Durchhang zu montieren, auch im Hinblick auf eventuelle Längenveränderungen der Schlauchleitung unter Druck. Torsionsbeanspruchung auf den Schlauch ist beim Einbau und im Betrieb zu vermeiden, sonst sind Axialdrehgelenke zu benutzen. Genügende Schlauchlänge vorsehen, damit die Schlauchleitung bei Bewegung der Maschinenteile nicht knickt.

Instructions de montages des tuyaux flexibles

Disposer les tuyaux flexibles de manière à pouvoir les monter et les contrôler facilement ; éviter tout contact avec les autres éléments de construction. Respecter les rayons de courbure minimum indiqués. En cas de mouvement fréquent, les augmenter de 50 % pour améliorer la durée de vie du tuyau. Installer chaque tuyau flexible avec un léger mou, en tenant compte également des éventuels changements de longueur du tuyau flexible sous pression. Eviter les sollicitations en torsion des tuyaux lors du montage et de l'utilisation, sinon utiliser des joints rotatifs axiaux. Prévoir une longueur de tuyau suffisante afin de ne pas plier le tuyau flexible lors du déplacement des parties de la machine.

Installation guidelines for hose lines

Hose lines must be arranged so that they are easy to install and check; chafing on other components must be avoided. It is essential that the stated minimum bending radii are complied with. In case of frequent movement the size of the hose should be increased by up to 50 % in order to improve the lifespan of the hose. Each hose line must be installed so that it sags, taking into consideration any changes in length of the hose line under pressure. Torsional strain on the hose must be avoided during installation and in operation. Otherwise, axial swivel joints should be used. Ensure that the hoses are long enough, so that the hose line does not kink due to the movement of machine components.

Richtige Montage

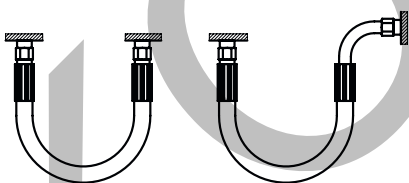

Montage correct



Correct installation

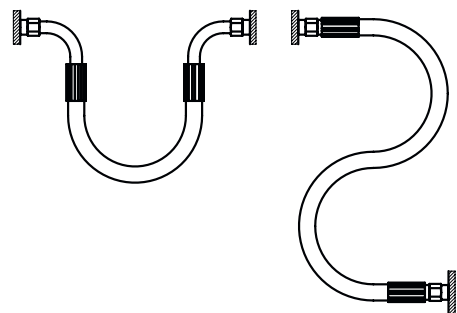

Falsche Montage

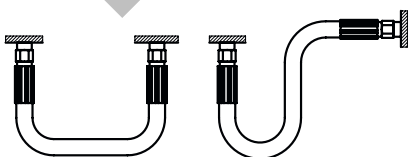

Montage incorrect

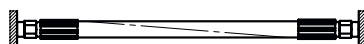

Incorrect installation

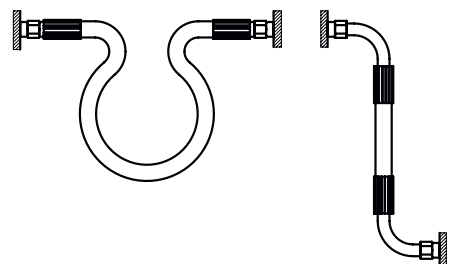

Verdrehwinkel bei gebogenen Armaturen

Werden links und rechts gebogene Armaturen eingesetzt, kann der Verdrehwinkel gewählt werden. Dieser wird, ausgehend vom 1. Anschluss, in Schritten von 45° im Gegenuhrzeigersinn definiert.

Beispiele:

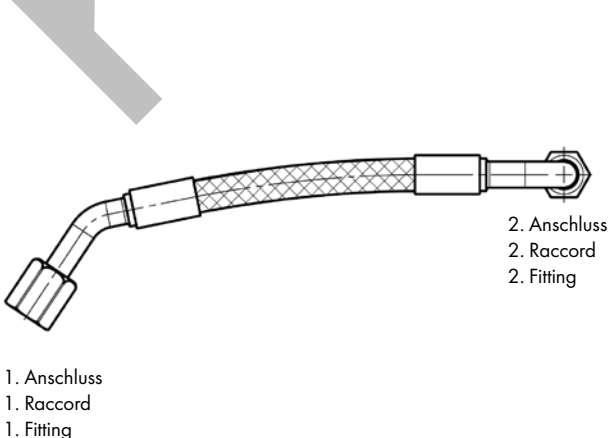
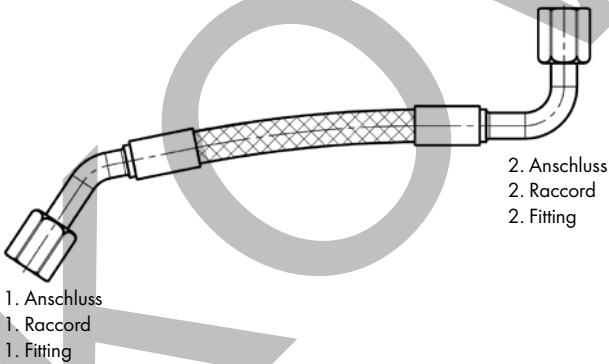
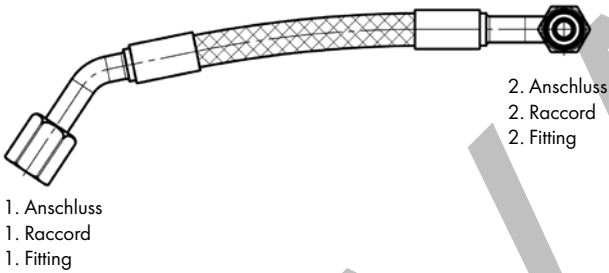
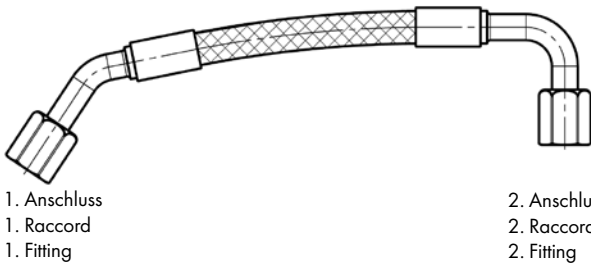

Exemples:

En cas d'utilisation de raccords coudés des deux côtés, l'angle d'orientation peut être sélectionné. Ceci est défini, à partir du 1. raccord, par pas de 45° dans le sens inverse des aiguilles d'une montre.

Rotation angle for angled fittings

If angled fittings are used on both sides, the rotation angle can be selected. This is defined, starting from the 1. fitting, in steps of 45° counterclockwise.

Examples:



Verdrehwinkel 0°
Angle d'orientation 0°
Rotation angle 0°

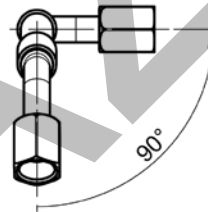

Verdrehwinkel 90°
Angle d'orientation 90°
Rotation angle 90°

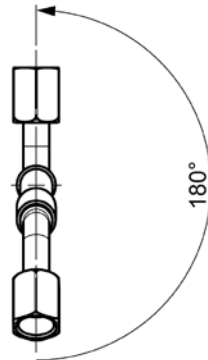

Verdrehwinkel 180°
Angle d'orientation 180°
Rotation angle 180°

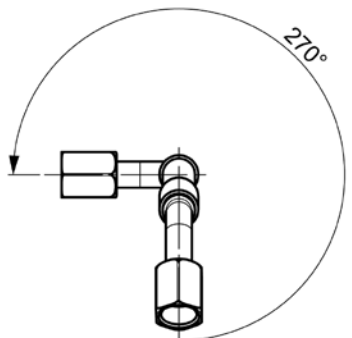

Verdrehwinkel 270°
Angle d'orientation 270°
Rotation angle 270°

Allgemeine Informationen

Permeabilität bei Jacoflon Schläuchen

Die Permeabilität ist der molekulare Transport von einem gasförmigen Medium durch einen physikalischen Festkörper durch:

1. Adsorbierung und Absorbierung auf der hohen Konzentrationsseite
2. Diffusion durch das Festmaterial z.B. Schlauchmaterial (PTFE-Seele) hindurch
3. Resorbierung von der tieferen Konzentrationsseite

Dieses sehr komplexe Problem in Kombination mit Kunststoffen wird zusätzlich negativ beeinflusst durch:

- den Lieferzustand
- die physikalischen Eigenschaften des Kunststoffes
- die chemische Zusammensetzung des Mediums und des verwendeten Kunststoffes

• Hochflexible Qualität HQ

Durch die extrem dünne PTFE-Seele wird eine maximale Flexibilität erreicht. Die dünne Seele führt jedoch zu einer höheren Permeabilität und ist somit nicht ideal für Gasanwendungen.

Permeationskonzentration

Die Differenz der Konzentration über das Medium zur Umgebung ist die treibende Kraft der Permeation und nicht zwingend der Nenndruck des Mediums im Schlauch. Die Permeabilität des Schlauches nimmt mit zunehmender Temperatur exponentiell zu.

Jacoflon in Vakuumanwendungen

Je kleiner die lichte Weite des Schlauches ist, desto eher kann der Schlauch in einer Vakuumanwendung eingesetzt werden. Wobei wir klar von Grobvakuum bis Feinvakuum sprechen. Das Vakuum ist begrenzt durch die Permeabilität des Schlauches sowie das Kollabieren der PTFE-Seele.

Statische Anwendungen

Durch die Permeabilität gegeben sind Anwendungen mit gasförmigen Medien nur empfohlen, wenn eine kontinuierliche Förderung und Druckerzeugung gewährleistet ist. Bsp.: Eine Feuerlöschleitung gefüllt mit 60 bar CO₂ wird über die Zeit Druck verlieren und somit drucklos sein.

Interpretation des Sicherheitsfaktors

Der Sicherheitsfaktor bei Jacoflon Schläuchen wird mit Wasser oder Hydrauliköl mit rascher Druckzunahme ermittelt. Wobei der Druckabfall nicht berücksichtigt wird, sondern nur das Versagen des Schlauches/Geflechtes.

Informations générales

Perméabilité des tuyaux Jacoflon

La perméabilité est le transport moléculaire d'un fluide gazeux au travers d'un corps solide par les procédés suivants:

1. Adsorption et absorption sur l'interface de concentration élevée
2. Diffusion par la matière solide, p. ex. le matériau du tuyau (âme en PTFE)
3. Résorption de l'interface de concentration inférieure

Ce problème très complexe associé aux plastiques subit également l'influence négative des éléments suivants:

- l'état de livraison
- les propriétés physiques du plastique
- la composition chimique du fluide et du plastique utilisé

• Qualité forte flexible HQ

Une flexibilité maximale est obtenue grâce à l'âme en PTFE extrêmement fine. Cependant, l'âme fine conduit à une perméabilité plus élevée et n'est donc pas idéale pour les applications gaz.

Concentration de perméation

La différence de concentration dans le fluide par rapport à l'environnement correspond à la force motrice de la perméation et pas nécessairement à la pression nominale du fluide dans le tuyau.

La perméabilité du tuyau augmente exponentiellement lorsque la température monte.

Jacoflon dans les applications sous vide

Plus le diamètre intérieur du tuyau est petit, plus le tuyau convient pour les applications sous vide. Il s'agit clairement du vide grossier au vide poussé. Le vide est limité par la perméabilité du tuyau et l'affaissement de l'âme PTFE.

Applications statiques

Compte tenu de la perméabilité, les applications avec fluide gazeux ne sont recommandées qu'en cas de transport continu et de production de pression.

Exemple: Un collecteur principal d'incendie contenant 60 bar de CO₂ perdra de la pression au fil du temps et ne sera donc plus sous pression.

Interprétation du coefficient de sécurité

Pour les tuyaux Jacoflon, le coefficient de sécurité est déterminé par une hausse de pression rapide avec de l'eau ou de l'huile hydraulique. La chute de pression n'est pas prise en compte, mais bien le défaut du tuyau/de la tresse.

General information

Permeability of Jacoflon hoses

Permeability is the molecular transport of a gaseous medium through a physical, solid body by:

1. adsorption and absorption on the high concentration side,
2. diffusion through the solid material, e.g. hose material (PTFE core),
3. resorption from the low concentration side.

This very complex problem in combination with plastics is further negatively influenced by:

- the condition as delivered,
- the physical properties of the plastic,
- the chemical compositions of the medium and of the plastic used.

• High flexible quality HQ

Maximum flexibility is achieved by the extremely thin PTFE core. However, the thin core leads to a higher permeability and is therefore not ideal for gas applications.

Permeation concentration

The concentration difference between the medium and the surroundings is the driving force of permeation and not necessarily the nominal pressure of the medium in the hose. The permeability of the hose increases exponentially with increasing temperature.

Jacoflon in vacuum applications

The smaller the inner diameter of the hose, the more suitable it is for use in vacuum applications. It is clear that we speak of rough vacuum to high vacuum. The vacuum is limited by the permeability of the hose and the collapse of the PTFE core.

Static applications

Given by the permeability, applications with gaseous media are recommended only if continuous supply and pressurisation are assured. Example: A fire extinguisher line filled with CO₂ at 60 bar will, over time, lose pressure and eventually become completely depressurised.

Interpretation of the safety factor

The safety factor for Jacoflon hoses is determined for a sudden rise in pressure with water or hydraulic oil. No account is taken of the fall off in pressure but only of the failure of the hose/braid.

Jacoflon Automobilqualität AQ

Jacoflon Qualité automobile AQ

Jacoflon Automobile quality AQ

JF PTFE 1 AQ

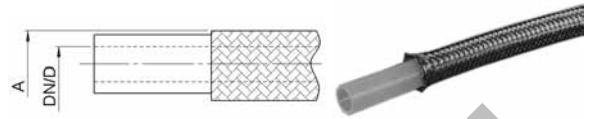

Type -DN	Mat.-Nr.	bar	D	A	B.Radius	L	kg/m
PTFE-1 AQ-1/8	490.3000.100	321	3.4	6.2	38	160.0	0.070
PTFE-1 AQ-3/16	490.3000.200	276	4.9	7.8	64	160.0	0.080

Automobile Qualität mit dickwandigem PTFE-Rohr und einfachem Drahtgeflecht (Inox 1.4301) für erhöhte Druckfestigkeit.

Qualité standard industrie automobile avec tube en PTFE à paroi épaisse et tresse en fil simple (inox 1.4301) pour résistance à la haute pression.

Automotive quality with thick-walled PTFE tube and single braid (inox 1.4301) for increased pressure resistance.

Jacoflon Gasqualität GQ

Jacoflon Qualité gaz GQ

Jacoflon Gas quality GQ

JF PTFE 1 GQ

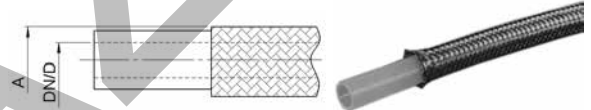

Type -DN	Mat.-Nr.	bar	D	A	B.Radius	L	kg/m
PTFE-1 GQ-1/8	490.4000.100	233	3.5	6.4	38	180.0	0.090

Gasqualität GQ mit molekularverdichtetem PTFE-Rohr und einfachem Drahtgeflecht (Inox 1.4301) - vermindert die Permeabilität für Produkte mit sehr feiner Molekularstruktur.

Qualité gaz GQ avec tube en PTFE à structure moléculaire comprimé et tresse en fil simple (inox 1.4301) - réduit la perméabilité pour produits avec structure moléculaire fine.

Gas quality GQ with molecular compressed PTFE tube and single braid (inox 1.4301) - reduces the permeability for products with very small molecular structure.

Jacoflon Hochflexible Qualität HQ

Jacoflon Qualité forte flexible HQ

Jacoflon High flexible quality HQ

JF PTFE 1 HQ

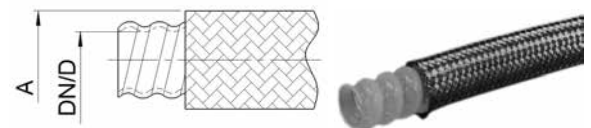

Type -DN	Mat.-Nr.	bar	D	A	B.Radius	L	kg/m
PTFE-1 HQ-3/8 GFL	490.9001.500	138	9.5	14.8	20	210.0	0.250
PTFE-1 HQ-1/2 GFL	490.9001.600	103	12.8	18.8	25	240.0	0.300
PTFE-1 HQ-3/4 GFL	490.9001.800	69	19.1	24.7	64	250.0	0.400
PTFE-1 HQ-1 GFL	490.9001.900	46	25.4	32.8	89	280.0	0.550

Hochflexible Qualität HQ, Wellschlauch mit einfachem Drahtgeflecht (Inox 1.4301).

Qualité HQ, grande flexibilité tube convoluté avec tresse en fil simple (inox 1.4301).

High flexible quality HQ, corrugated hose with single wire jacket (inox 1.4301).

L=Mindestlänge konfektioniert
bar=Arbeitsdruck bei 23°C
DN/D=Rohrinnendurchmesser
A=Rohraussendurchmesser
B.Radius=min. Biegeradius

L=longeur min. assemblée
bar=pression de service à 23°C
DN/D=diamètre intérieur du tube
A=diamètre extérieur du tube
B.Radius=min. rayon de courbure

L=min. length assembled
bar=operation pressure at 23°C
DN/D=tube inside diameter
A=tube outside diameter
B.Radius=min. bend radius

Jacoflon Standardqualität SQ

mit einfachem Drahtgeflecht

Jacoflon Qualité standard SQ

avec tresse en fil simple

Jacoflon Standard quality SQ

with single braid

JF PTFE 1 SQ

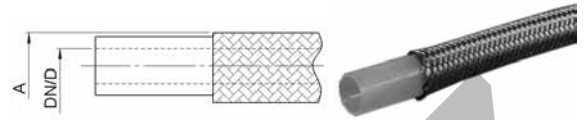

Type -DN	Mat.-Nr.	bar	D	A	B.Radius	L	kg/m
PTFE-1 SQ DN 2,5	490.1000.010	330	2.5	4.5	25	180.0	0.100
PTFE-1 SQ-1/4	490.1000.300	241	6.2	8.6	76	180.0	0.100
PTFE-1 SQ-3/8	490.1000.500	219	8.9	11.7	127	190.0	0.150
PTFE-1 SQ-1/2	490.1000.600	161	12.3	15.4	140	215.0	0.210

Standardqualität SQ mit einfachem Drahtgeflecht (Inox 1.4301).

Qualité standard SQ avec tresse en fil simple (inox 1.4301).

Standard quality SQ with single braid (inox 1.4301).

Jacoflon Standardqualität SQ

mit zweifachem Drahtgeflecht

Jacoflon Qualité standard SQ

avec double tresse

Jacoflon Standard quality SQ

with double braid

JF PTFE 2 SQ

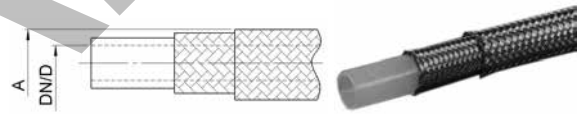

Type -DN	Mat.-Nr.	bar	D	A	B.Radius	L	kg/m
PTFE-2 SQ-3/16	490.2000.200	299	4.9	8.9	64	160.0	0.120
PTFE-2 SQ-1/4	490.2000.300	276	6.2	9.8	76	180.0	0.160
PTFE-2 SQ-3/8	490.2000.500	252	8.9	13.0	127	190.0	0.260
PTFE-2 SQ-1/2	490.2000.600	183	12.4	16.9	140	215.0	0.350
PTFE-2 SQ-5/8	490.2000.700	172	15.2	19.7	165	210.0	0.500
PTFE-2 SQ-3/4	490.2000.800	149	18.9	23.6	203	230.0	0.670
PTFE-2 SQ-1	490.2000.900	92	25.4	31.0	305	230.0	0.860

Standardqualität SQ mit zweifachem Drahtgeflecht (Inox 1.4301) für erhöhte Druck- und Biegefestigkeit.

Qualité standard SQ avec double tresse (inox 1.4301) pour une meilleure résistance à la pression et à la flexion augmentée.

Standard quality SQ with double wire jacket (inox 1.4301) for increased pressure and flexural strength.

L=Mindestlänge konfektioniert
bar=Arbeitsdruck bei 23°C
DN/D=Rohrinnendurchmesser
A=Rohraussendurchmesser
B.Radius=min. Biegeradius

L=longeur min. assemblée
bar=pression de service à 23°C
DN/D=diamètre intérieur du tube
A=diamètre extérieur du tube
B.Radius=min. rayon de courbure

L=min. length assembled
bar=operation pressure at 23°C
DN/D=tube inside diameter
A=tube outside diameter
B.Radius=min. bend radius

Rohrstutzen

für SERTO-Verschraubung

Embout lisse

pour raccords SERTO

Cylindrical stub

for SERTO unions

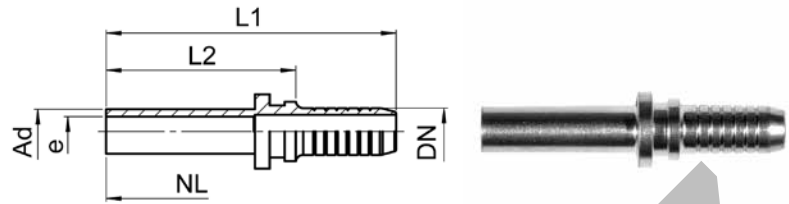
JES-A

Type -DN -Ad	Mat.-Nr.	L1	L2	e	kg/100	1 AQ	1 GQ	1 HQ	1 SQ	2 SQ
JESTR DN2,5 -A6	495.1105.010	29,5	19,5	1,3	0,252				✓	
JESTR 1/8 -A3	495.1105.105	32,0	18,5	1,5	0,770	✓				
JESTR 1/8 -A6	495.1105.115	37,0	23,5	2,0	0,930	✓	✓			
JESTR 3/16 -A6	495.1105.215	39,0	25,5	3,0	1,010	✓				
JESTR 1/4 -A6	495.1105.315	39,0	25,5	4,0	1,110				✓	✓
JESTR 1/4 -A8	495.1105.319	41,0	27,5	4,5	1,270				✓	✓
JESTR 3/8 -A10	495.1105.522	46,0	29,5	7,0	1,840				✓	✓
JESTR 3/8 -A12	495.1105.525	47,0	30,5	7,0	2,380				✓	✓
JESTR 1/2 -A12	495.1105.625	50,0	30,5	9,0	3,110				✓	✓
JESTR 1/2 -A15	495.1105.635	50,0	30,5	9,5	3,630				✓	✓
JESTR 5/8 -A18	495.1105.750	58,0	35,5	12,0	6,010					✓
JESTR 3/4 -A22	495.2105.854	58,0	35,5	15,0	7,180					✓
JESTR 1 -A28	495.2105.961	74,0	51,5	21,0	14,320					✓
JESTR 3/8 -A10 HQ	495.8105.522	63,5	30,5	7,0	1,900			✓		
JESTR 3/8 -A12 HQ	495.8105.525	64,5	31,5	7,0	2,200			✓		
JESTR 1/2 -A15 HQ	495.8105.635	73,5	35,5	9,5	3,700			✓		
JESTR 3/4 -A22 HQ	495.8105.854	81,5	38,5	15,0	6,600			✓		
JESTR 1 -A28 HQ	495.8105.961	100,0	53,5	20,0	15,900			✓		

Rohrstutzen 45°

für SERTO-Verschraubung

Embout lisse 45°

pour raccords SERTO

Cylindrical stub 45°

for SERTO unions

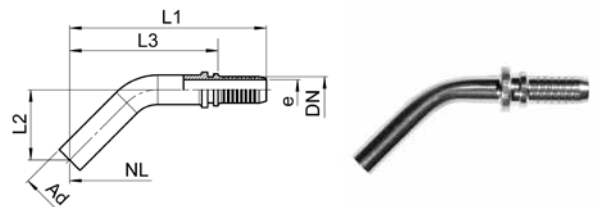
JES-A 45°

Type -DN -Ad	Mat.-Nr.	L1	L2	L3	e	kg/100	1 AQ	1 GQ	1 HQ	1 SQ	2 SQ
JESTR 1/8 -A6 45°	495.1145.115	48,5	16,0	35,0	2,0	0,600	✓	✓			
JESTR 3/16 -A6 45°	495.1145.215	48,5	16,0	35,0	2,8	0,720	✓				✓
JESTR 1/4 -A6 45°	495.1145.315	48,5	16,0	35,0	4,0	0,800				✓	✓
JESTR 1/4 -A8 45°	495.1145.319	58,0	20,0	45,0	4,5	1,480				✓	✓
JESTR 3/8 -A10 45°	495.1145.522	67,0	25,0	50,5	7,0	2,260				✓	✓
JESTR 3/8 -A12 45°	495.1145.525	76,0	29,0	59,5	7,0	3,080				✓	✓
JESTR 1/2 -A12 45°	495.1145.625	78,5	30,0	59,0	9,5	3,250				✓	✓
JESTR 1/2 -A15 45°	495.1145.635	97,0	40,0	77,0	9,5	5,540				✓	✓

Rohrstutzen 90°

für SERTO-Verschraubung

Embout lisse 90°

pour raccords SERTO

Cylindrical stub 90°

for SERTO unions

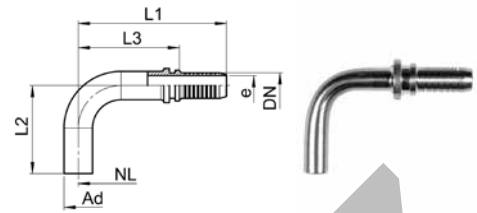

JES-A 90°

Type -DN -Ad	Mat.-Nr.	L1	L2	L3	e	kg/100	1 AQ	1 GQ	1 HQ	1 SQ	2 SQ
JESTR 1/8 -A6 90°	495.1195.115	37.0	22.0	23.5	2.0	0.600	✓	✓			
JESTR 3/16 -A6 90°	495.1195.215	37.0	22.0	23.5	2.8	0.720	✓				
JESTR 1/4 -A6 90°	495.1195.315	37.0	22.0	23.5	4.5	0.800				✓	✓
JESTR 1/4 -A8 90°	495.1195.319	44.0	29.0	30.5	4.5	1.480				✓	✓
JESTR 3/8 -A10 90°	495.1195.522	49.0	36.0	32.5	7.0	2.260				✓	✓
JESTR 3/8 -A12 90°	495.1195.525	57.0	39.0	40.5	7.0	3.080				✓	✓
JESTR 1/2 -A12 90°	495.1195.625	60.0	39.0	41.0	9.5	3.250				✓	✓
JESTR 1/2 -A15 90°	495.1195.635	69.5	62.0	50.0	9.5	5.540				✓	✓

Rohrstutzen

mit SERTO-Armaturenanschluss

Embout lisse

avec ecrou de raccord SERTO

Cylindrical stub

with SERTO nut connection

JES-SO

Type -DN -d -M	Mat.-Nr.	bar	SW	L1	L2	e	kg/100	1 AQ	1 GQ	1 HQ	1 SQ	2 SQ
JESSO DN2,5 -6 -M10x1	497.1105.010	200	12	31.0	21.0	1.3	1.100				✓	
JESSO 1/8 -3 -M6x0.75	497.1105.105	250	8	33.0	19.5	1.5	1.040	✓	✓			
JESSO 1/8 -6 -M10x1	497.1105.115	200	12	38.5	25.0	2.0	1.720	✓	✓			
JESSO 3/16 -6 -M10x1	497.1105.215	200	12	40.5	27.0	3.0	1.800	✓				✓
JESSO 1/4 -6 -M10x1	497.1105.315	200	12	40.5	27.0	4.0	1.900				✓	✓
JESSO 1/4 -8 -M12x1	497.1105.319	200	14	42.5	29.0	4.5	2.320				✓	✓
JESSO 3/8 -10 -M14x1	497.1105.522	160	17	47.5	31.0	7.0	3.620				✓	✓
JESSO 3/8 -12 -M16x1	497.1105.525	160	19	48.5	32.0	7.0	4.590				✓	✓
JESSO 1/2 -12 -M16x1	497.1105.625	160	19	51.5	32.0	9.0	5.320				✓	✓
JESSO 1/2 -15 -M20x1.5	497.1105.635	100	24	51.5	32.0	9.5	7.840				✓	✓
JESSO 3/8 -18 -M24x1.5	497.1105.750	100	30	59.5	37.0	12.0	11.060					✓
JESSO 3/4 -22 -M28x1.5	497.2105.854	64	32	59.5	37.0	15.0	15.340					✓
JESSO 1 -28 -M36x2	497.2105.961	40	41	76.0	53.5	21.0	29.320					✓
JESSO 3/8 -10 -M14x1 HQ	497.8105.522	138	17	65.0	32.0	7.0	4.200			✓		
JESSO 3/8 -12 -M16x1 HQ	497.8105.525	138	19	66.0	33.0	7.0	5.400			✓		
JESSO 1/2 -15 -M20x1.5 HQ	497.8105.635	100	24	75.0	37.0	9.5	9.100			✓		
JESSO 3/4 -22 -M28x1.5 HQ	497.8105.854	64	32	83.0	40.0	15.0	16.600			✓		
JESSO 1 -28 -M36x2 HQ	497.8105.961	40	41	102.0	55.5	20.0	34.400			✓		

Bei Kombinationen Jacoflon-Schlauch mit JES-SO Armaturen gilt die jeweils schwächere Druckangabe.

Pour des combinaisons de tuyaux Jacoflon équipés de raccords JES-SO, il faut prendre en compte la pression la plus faible des composants.

For combinations Jacoflon tube with JES-SO unions, the lower pressure value applies.

NL=Nennlänge des Schlauches gemäß Massbild
DN/D=Rohrinnendurchmesser
✓=Kombinationsmöglichkeit Armatur / Schlauch

NL=longueur nominale du tuyau selon plan coté
DN/D=diamètre intérieur du tube
✓=possibilité de combinaison raccord / tuyaux

NL=nominal length of tube as per drawing
DN/D=tube inside diameter
✓=possible combinations fitting / hose

Rohrstutzen 45°

mit SERTO-Armaturenanschluss

Embout lisse 45°

avec ecrou de raccord SERTO

Cylindrical stub 45°

with SERTO nut connection

JES-SO 45°

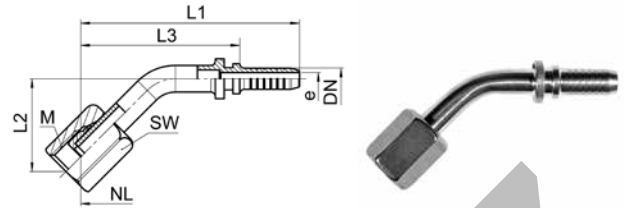

Type -DN -d -M	Mat.-Nr.	bar	SW	L1	L2	L3	e	kg/100	1AQ	1GQ	1HQ	1SQ	2SQ
JESSO 1/8 -6 -M10x1 45°	497.1145.115	200	12	49.5	20.0	36.0	2.0	1.390	✓	✓			
JESSO 3/16 -6 -M10x1 45°	497.1145.215	200	12	49.5	20.0	36.0	2.8	1.510	✓				
JESSO 1/4 -6 -M10x1 45°	497.1145.315	200	12	49.5	20.0	36.0	4.0	1.590					
JESSO 1/4 -8 -M12x1 45°	497.1145.319	200	14	59.0	25.0	45.5	4.5	1.850				✓	✓
JESSO 3/8 -10 -M14x1 45°	497.1145.522	160	17	68.0	30.0	51.5	7.0	4.040				✓	✓
JESSO 3/8 -12 -M16x1 45°	497.1145.525	160	19	77.0	33.5	60.5	7.0	4.470				✓	✓
JESSO 1/2 -12 -M16x1 45°	497.1145.625	160	19	79.5	34.5	60.0	9.5	5.460				✓	✓
JESSO 1/2 -15 -M20x1.5 45°	497.1145.635	100	24	98.0	45.5	78.0	9.5	7.460				✓	✓

Bei Kombinationen Jacoflon-Schlauch mit JES-SO Armaturen gilt die jeweils schwächere Druckangabe.

Pour des combinaisons de tuyaux Jacoflon équipés de raccords JES-SO, il faut prendre en compte la pression la plus faible des composants.

For combinations Jacoflon tube with JES-SO unions, the lower pressure value applies.

Rohrstutzen 90°

mit SERTO-Armaturenanschluss

Embout lisse 90°

avec ecrou de raccord SERTO

Cylindrical stub 90°

with SERTO nut connection

JES-SO 90°

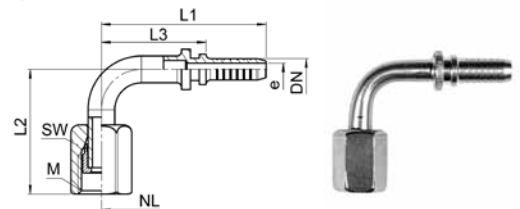

Type -DN -d -M	Mat.-Nr.	bar	SW	L1	L2	L3	e	kg/100	1AQ	1GQ	1HQ	1SQ	2SQ
JESSO 1/8 -6 -M10x1 90°	497.1195.115	200	12	37.0	29.0	23.5	2.0	1.390	✓	✓			
JESSO 3/16 -6 -M10x1 90°	497.1195.215	200	12	37.0	29.0	23.5	2.8	1.510	✓				✓
JESSO 1/4 -6 -M10x1 90°	497.1195.315	200	12	37.0	29.0	23.5	4.5	1.590				✓	✓
JESSO 1/4 -8 -M12x1 90°	497.1195.319	200	14	44.0	32.5	30.5	4.5	1.850				✓	✓
JESSO 3/8 -10 -M14x1 90°	497.1195.522	160	17	49.0	42.5	32.5	7.0	4.040				✓	✓
JESSO 3/8 -12 -M16x1 90°	497.1195.525	160	19	57.0	45.5	40.5	7.0	4.470				✓	✓
JESSO 1/2 -12 -M16x1 90°	497.1195.625	160	19	60.0	46.5	40.5	9.5	5.460				✓	✓
JESSO 1/2 -15 -M20x1.5 90°	497.1195.635	100	24	69.5	62.0	50.0	9.5	7.460				✓	✓

Bei Kombinationen Jacoflon-Schlauch mit JES-SO Armaturen gilt die jeweils schwächere Druckangabe.

Pour des combinaisons de tuyaux Jacoflon équipés de raccords JES-SO, il faut prendre en compte la pression la plus faible des composants.

For combinations Jacoflon tube with JES-SO unions, the lower pressure value applies.

Stutzen

mit konischem Anschlussgewinde

Raccord

avec adaptateur mâle conique

Connector

with conical male adaptor

JES-R

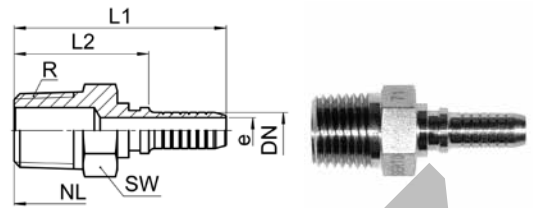

Type -DN -R	Mat.-Nr.	SW	L1	L2	e	kg/100	1 AQ	1 GQ	1 HQ	1 SQ	2 SQ
JESTA 1/8 -1/8	495.1605.110	10	32.0	18.5	2.0	1.260	✓	✓			
JESTA 3/16 -1/8	495.1605.210	10	32.0	18.5	3.0	1.310	✓				
JESTA 3/16 -1/4	495.1605.217	14	37.0	23.5	3.0	1.940	✓				
JESTA 1/4 -1/4	495.1605.317	14	37.0	23.5	4.5	2.320				✓	✓
JESTA 3/8 -3/8	495.1605.520	17	42.0	25.5	7.0	3.760				✓	✓
JESTA 1/2 -1/2	495.1605.630	22	48.0	28.5	9.5	6.570				✓	✓
JESTA 5/8 -3/4	495.1605.750	27	54.0	31.5	12.0	10.380					✓
JESTA 3/4 -3/4	495.2605.850	27	55.0	32.5	15.0	12.980					✓
JESTA 1 -1	495.2605.960	36	61.0	38.5	21.0	22.940					✓
JESTA 3/8 -3/8 HQ	495.8605.520	17	59.5	26.5	7.0	3.500			✓		
JESTA 1/2 -1/2 HQ	495.8605.630	22	69.5	31.5	9.5	6.900			✓		
JESTA 3/4 -3/4 HQ	495.8605.850	27	77.5	34.5	15.0	12.400			✓		
JESTA 1 -1 HQ	495.8605.960	36	87.0	40.5	20.0	25.200			✓		

Stutzen mit Universaldichtkegel 60°

mit Überwurfmutter

Raccord avec cône d'étanchéité 60°

avec écrou

Connector with conical sealing nipple 60°

with union nut

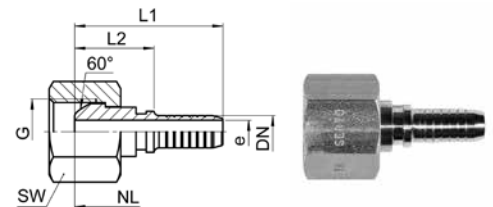

JES-DK

Type -DN -G	Mat.-Nr.	SW	L1	L2	e	kg/100	1 AQ	1 GQ	1 HQ	1 SQ	2 SQ
JESDK 60° -1/8 -1/8	497.1355.110	14	28.0	14.5	2.0	2.050	✓	✓			
JESDK 60° -3/16 -1/4	497.1355.217	17	29.0	15.5	3.0	3.010	✓				✓
JESDK 60° -1/4 -1/4	497.1355.317	17	29.0	15.5	4.5	3.030				✓	✓
JESDK 60° -3/8 -3/8	497.1355.520	19	33.0	16.5	7.0	3.780				✓	✓
JESDK 60° -1/2 -1/2	497.1355.630	24	38.0	18.5	9.5	6.720				✓	✓
JESDK 60° -5/8 -3/4	497.1355.750	32	39.0	16.5	12.0	11.970					✓
JESDK 60° -3/4 -3/4	497.2355.850	32	39.0	16.5	15.0	11.710					✓
JESDK 60° -1 -1	497.2355.960	41	40.0	17.5	21.0	21.260					✓
JESDK 60° -3/8 -3/8 HQ	497.8355.520	19	50.5	17.5	7.0	3.600			✓		
JESDK 60° -1/2 -1/2 HQ	497.8355.630	24	58.5	20.5	9.5	6.600			✓		
JESDK 60° -3/4 -3/4 HQ	497.8355.850	32	61.0	18.0	15.0	11.100			✓		
JESDK 60° -1 -1 HQ	497.8355.960	41	66.0	19.5	20.0	22.800			✓		

45° Stutzen mit Universaldichtkegel 60°

mit Überwurfmutter

Raccord 45° avec cône d'étanchéité 60°

avec écrou

45° connector with conical sealing nipple 60°

with union nut

JES-DK 45°

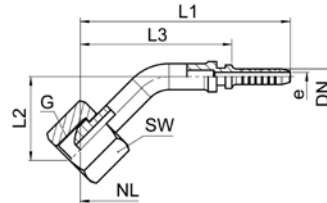

Type -DN -G	Mat.-Nr.	SW	L1	L2	L3	e	kg/100	1AQ	1GQ	1HQ	1SQ	2SQ
JESDK 60° -1/8 -1/8 45°	497.1345.110	14	48.5	19.5	35.0	2.0	1.900	✓	✓			
JESDK 60° -1/4 -1/4 45°	497.1345.317	17	54.5	23.5	41.0	4.0	3.350				✓	✓
JESDK 60° -3/8 -3/8 45°	497.1345.520	19	69.5	23.5	53.0	7.0	4.400				✓	✓
JESDK 60° -1/2 -1/2 45°	497.1345.630	24	92.0	31.0	72.5	9.0	10.300				✓	✓

90° Stutzen mit Universaldichtkegel 60°

mit Überwurfmutter

Raccord 90° avec cône d'étanchéité 60°

avec écrou

90° connector with conical sealing nipple 60°

with union nut

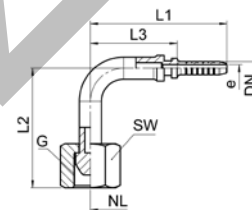

JES-DK 90°

Type -DN -G	Mat.-Nr.	SW	L1	L2	L3	e	kg/100	1AQ	1GQ	1HQ	1SQ	2SQ
JESDK 60° -1/8 -1/8 90°	497.1395.110	14	33.0	30.5	19.5	2.0	1.900	✓	✓			
JESDK 60° -1/4 -1/4 90°	497.1395.317	17	38.5	35.0	25.0	4.0	3.350				✓	✓
JESDK 60° -3/8 -3/8 90°	497.1395.520	19	50.5	46.5	34.0	7.0	4.400				✓	✓
JESDK 60° -1/2 -1/2 90°	497.1395.630	24	66.0	49.0	46.5	9.0	10.300				✓	✓

Stutzen mit Planfläche mit PTFE-Dichtring

mit Überwurfmutter

Raccord avec surface plane avec joint torique en PTFE

avec écrou

Connector with flat face end with PTFE gasket

with union nut

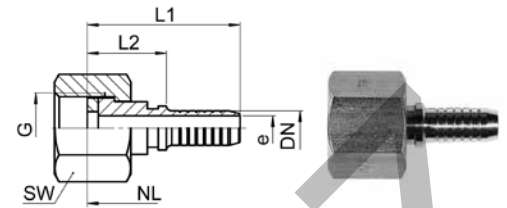

JES-PL

Type -DN -G	Mat.-Nr.	SW	L1	L2	e	kg/100	1 AQ	1 GQ	1 HQ	1 SQ	2 SQ
JESPL -1/8 -1/8	497.1365.110	14	26.5	13.0	2.0	1.980	✓	✓			
JESPL -3/16 -1/4	497.1365.217	17	28.0	14.5	3.0	2.910	✓				✓
JESPL -1/4 -1/4	497.1365.317	17	28.0	14.5	4.5	2.940				✓	✓
JESPL -3/8 -3/8	497.1365.520	19	31.0	14.5	7.0	3.590				✓	✓
JESPL -1/2 -1/2	497.1365.630	24	34.0	14.5	9.5	6.240				✓	✓
JESPL -5/8 -3/4	497.1365.750	32	36.0	13.5	12.0	11.110					✓
JESPL -3/4 -3/4	497.2365.850	32	37.0	14.5	15.0	11.320					✓
JESPL -1 -1	497.2365.960	41	38.0	15.5	21.0	20.620					✓
JESPL -3/8 -3/8 HQ	497.8365.520	19	48.5	17.5	7.0	3.400			✓		
JESPL -1/2 -1/2 HQ	497.8365.630	24	55.0	17.0	9.5	6.200			✓		
JESPL -3/4 -3/4 HQ	497.8365.850	32	60.0	17.0	15.0	10.900			✓		
JESPL -1 -1 HQ	497.8365.960	41	64.0	17.5	20.0	22.000			✓		

45° Stutzen mit Planfläche mit PTFE-Dichtring

mit Überwurfmutter

Raccord 45° avec surface plane avec joint torique en PTFE

avec écrou

45° connector with flat face end with PTFE gasket

with union nut

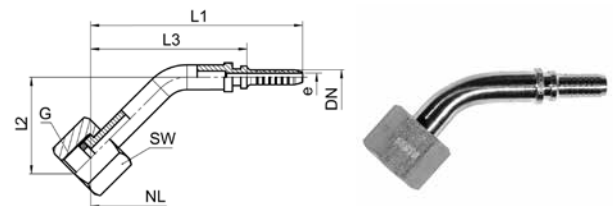

JES-PL 45°

Type -DN -G	Mat.-Nr.	SW	L1	L2	L3	e	kg/100	1 AQ	1 GQ	1 HQ	1 SQ	2 SQ
JESPL -1/8 -1/8 45°	497.1340.110	14	53.0	20.0	40.0	2.0	1.950	✓	✓			
JESPL -1/4 -1/4 45°	497.1340.317	17	54.5	23.0	41.0	4.0	3.250				✓	✓
JESPL -3/8 -3/8 45°	497.1340.520	19	68.0	25.0	52.0	7.0	4.100				✓	✓
JESPL -1/2 -1/2 45°	497.1340.630	24	90.0	31.5	70.5	9.0	6.800				✓	✓

90° Stutzen mit Planfläche mit PTFE-Dichtring

mit Überwurfmutter

Raccord 90° avec surface plane avec joint torique en PTFE

avec écrou

90° connector with flat face end with PTFE gasket

with union nut

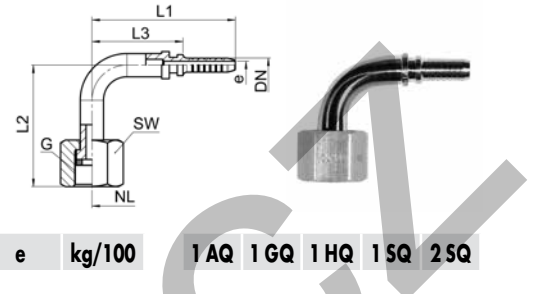

JES-PL 90°

Type -DN-G	Mat.-Nr.	SW	L1	L2	L3	e	kg/100	1AQ	1GQ	1HQ	1SQ	2SQ
JESPL -1/8 -1/8 90°	497.1390.110	14	42.0	28.5	28.5	2.0	1.950	✓	✓			
JESPL -1/4 -1/4 90°	497.1390.317	17	38.5	34.0	25.0	4.0	3.250				✓	✓
JESPL -3/8 -3/8 90°	497.1390.520	19	50.5	34.5	34.0	7.0	4.100				✓	✓
JESPL -1/2 -1/2 90°	497.1390.630	24	67.0	46.5	47.5	9.0	6.800				✓	✓

Dichtscheibe PTFE

für Planfläche

Joint plat en PTFE

pour surface plane

PTFE gasket

for flat face end

J-PTFE-SCHEIBE

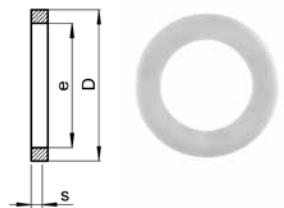

Type	Mat.-Nr.	D	e	s	kg/100
J-PTFE-Scheibe: 1/8 8/5x1,5	496.1808.110	8.0	5.0	1.50	0.100
J-PTFE-Scheibe: 1/4 1 1/8x2	496.1808.317	11.0	6.0	2.00	0.100
J-PTFE-Scheibe: M14x1,5 12/7x2	496.1808.319	12.0	7.0	2.00	0.100
J-PTFE-Scheibe: 3/8 14/9x2	496.1808.520	14.0	9.0	2.00	0.100
J-PTFE-Scheibe: 1/2 16/10x2	496.1808.525	16.0	10.0	2.00	0.100
J-PTFE-Scheibe: 3/4 18/12x2	496.1808.630	18.0	12.0	2.00	0.100
J-PTFE-Scheibe: M22x1,5 19.5/12x2	496.1808.632	19.5	12.0	2.00	0.100
J-PTFE-Scheibe: 3/4 24/18x2	496.2808.850	24.0	18.0	2.00	0.100
J-PTFE-Scheibe: 1 30/20x2	496.2808.960	30.0	20.0	2.00	0.100

Rohrschellen

Colliers de serrage

Tube clamps



Seite/Page/Page

Seite/Page/Page

Schellenkörper PP, Serie A
Corps de collier PP, série A
Clamp body PP, series A

752-753



RS RGA-PP

Anschweisplatte kurz, Serie B
Plaque à souder courte, série B
Weld-on plate short, series B

762



RS AKZ3B

Tragschiene, Serie A
Rail de support, série A
Mounting rail, series A

770



RS TS

Schellenkörper PA, Serie A
Corps de collier PA, série A
Clamp body PA, series A

754-755



RS RGA-PA

Deckplatte, Serie A
Plaque de couverture, série A
Cover plate, series A

763



RS DPA

Tragschienenmutter, Serie A
Écrou pour rail de support, série A
Rail nut, series A

771



RS TMA/TMVA

Schellenkörper PA flammh., Serie A
Corps de collier PA ignifugé, série A
Clamp body PA flame ret., series A

756



RS RGA-PA F

Deckplatte, Serie B
Plaque de couverture, série B
Cover plate, series B

764



RS DPB

Tragschienenmutter, Serie B
Écrou pour rail de support, série B
Rail nut, series B

772



RS TMB

Schellenkörper Aluminium, Serie A
Corps de collier aluminium, série A
Clamp body aluminium, series A

757



RS RGA-AL

Sechskantschraube, Serie A
Vis à tête hexagonale, série A
Hexagon screw, series A

765



RS SSA

Schellenkörper PP, Serie B
Corps de collier PP, série B
Clamp body PP, series B

758

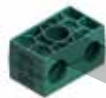

RS RGB-PP

Sechskantschraube, Serie B
Vis à tête hexagonale, série B
Hexagon screw, series B

766



RS SSB

Schellenkörper PA, Serie B
Corps de collier PA, série B
Clamp body PA, series B

759



RS RGB-PA

Innensechskantschraube, Serie A
Vis à six pans creux, série A
Hexagon socket screw, series A

767



RS ISA

Schellenkörper PA flammh., Serie B
Corps de collier PA ignifugé, série B
Clamp body PA flame ret., series B

760



RS RGB-PA F

Innensechskantschraube, Serie B
Vis à six pans creux, série B
Hexagon socket screw, series B

768



RS ISB

Anschweisplatte kurz, Serie A
Plaque à souder courte, série A
Weld-on plate short, series A

761



RS AKZ1A

Aufbauschraube, Serie A
Vis d'empilage, série A
Stacking screw, series A

769



RS ASA

Rohrschellen

Colliers de serrage

Tube clamps

Funktion

- Halten und Führen von Rohrleitungen
- Aufnahme von axialen und radialen Kräften
- Bewegungen verhindern oder dämpfen

Norm

leichte Baureihe Serie A/B, nach DIN 3015

Werkstoff

- Rohrschellen: PP, PA6, PA66 F, Aluminium
- Anschweißplatten: Stahl phosphatiert und Edelstahl 1.4571/1.4401
- Tragschienen: Stahl blank und Edelstahl 1.4571/1.4401
- Tragschienenmutter, Schrauben, Deckplatten: Stahl verzinkt und Edelstahl 1.4571/1.4401

Eigenschaften

PP Rohrschellen:

- -30°C bis +90°C
- leichter als Rohrschellen aus PA
- Rohrhaltekräfte von 0.6 kN bis 2.3 kN
- Farbe: dunkelgrün

PA6 Rohrschellen:

- -40°C bis +120°C
- schwerer als Rohrschellen aus PP
- Rohrhaltekräfte von 0.6 kN bis 3.5 kN
- leicht flammhemmend
- Farbe: schwarz

PA66 F Rohrschellen:

- -40°C bis +120°C
- schwerer als Rohrschellen aus PP
- Rohrhaltekräfte von 0.6 kN bis 3.5 kN
- Erfüllung der Anforderungssätze R22 / R23 / R24 / R26 für die Gefährdungsstufen HL1-HL2-HL3 nach EN 45545-2
- Farbe: weiss-grau

Aluminium Rohrschellen:

- -40°C bis +300°C
- Rohrhaltekräfte von 3.5 kN bis 8.9 kN
- Farbe: grau

Chemische Beständigkeit

Fonction

- fixation et guidage des tubes
- absorption de forces axiales et radiales
- prévenir ou atténuer les mouvements

Norm

série légèresérie A/B, selon DIN 3015

Matériau

- colliers de serrage: PP, PA6, PA66 F, aluminium
- plaques à souder: acier phosphaté et acier inoxydable 1.4571/1.4401
- rails de support: acier nu et acier inoxydable 1.4571/1.4401
- écrous pour rail de support, vis, plaques de couverture: acier zingué et acier inoxydable 1.4571/1.4401

Caractéristiques

Colliers de serrage en PP:

- -30°C à +90°C
- plus léger que colliers de serrage en PA
- forces de serrage des tubes 0.6 kN à 2.3 kN
- couleur: vert foncé

Colliers de serrage en PA6:

- -40°C à +120°C
- plus lourdes que colliers de serrage en PP
- forces de serrage des tubes 0.6 kN à 3.5 kN
- légèrement ignifugé
- couleur: noir

Colliers de serrage en PA66 F:

- -40°C à +120°C
- plus lourdes que colliers de serrage en PP
- forces de serrage des tubes 0.6 kN à 3.5 kN
- respect des exigences R22 / R23 / R24 / R26 pour les niveaux de danger HL1-HL2-HL3 selon la norme EN 45545-2
- couleur: blanc-gris

Colliers de serrage en aluminium:

- -40°C à +300°C
- forces de serrage des tubes 3.5 kN à 8.9 kN
- couleur: gris

Résistance chimique

Funktion

- fixation and guidance of tubes
- absorption of axial and radial forces
- to absorb or prevent movement

Norm

light series A/B, according to DIN 3015

Material

- tube clamps: PP, PA6, PA66 F, aluminium
- weld-on plates: steel phosphatized or stainless steel 1.4571/1.4401
- mounting rail: bright steel or stainless steel 1.4571/1.4401
- rail nuts, screws, cover plates: zinc-plated steel or stainless steel 1.4571/1.4401

Characteristics

Tube clamps made of PP:

- -30°C to +90°C
- lighter than tube clamps made of PA
- tube holding power 0.6 kN to 2.3 kN
- color: dark green

Tube clamps made of PA6:

- -40°C to +120°C
- heavier than tube clamps made of PP
- tube holding power 0.6 kN to 3.5 kN
- slightly flame retardant
- color: black

Tube clamps made of PA66 F:

- -40°C to +120°C
- heavier than tube clamps made of PP
- tube holding power 0.6 kN to 3.5 kN
- fulfilment of the requirement sets R22 / R23 / R24 / R26 for the hazard levels HL1-HL2-HL3 according to EN 45545-2
- color: white-grey

Tube clamps made of aluminium:

- -40°C to +300°C
- tube holding power 3.5 kN to 8.9 kN
- color: grey

Chemical resistance

	PP Rohrschellen Colliers de serrage en PP Tube clamps made of PP	PA Rohrschellen Colliers de serrage en PA Tube clamps made of PA	Aluminium Rohrschellen Colliers de serrage en aluminium Tube clamps made of aluminium
Säuren acides acids	bedingt beständig résistance restreinte limited resistance	bedingt beständig résistance restreinte limited resistance	bedingt beständig résistance restreinte limited resistance
Laugen bases alkalis	bedingt beständig résistance restreinte limited resistant	bedingt beständig résistance restreinte limited resistance	bedingt beständig résistance restreinte limited resistance
Alkohole alcools alcohols	beständig résistant resistant	beständig résistant resistant	beständig résistant resistant
Benzin essence gasoline	bedingt beständig résistance restreinte limited resistance	beständig résistant resistant	beständig résistant resistant
Mineralöl huile minérale mineral oil	bedingt beständig résistance restreinte limited resistant	beständig résistant resistant	beständig résistant resistant
sonstige Öle autres huiles other oils	beständig résistant resistant	beständig résistant resistant	beständig résistant resistant

Schellenkörper

PP, Serie A

Corps de collier

PP, série A

Clamp body

PP, series A

RS RGA-PP

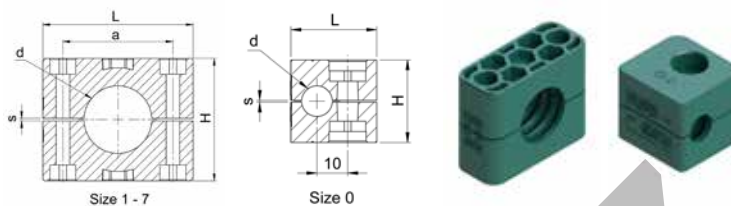

Type -S-d	Mat.-Nr.	d (")	G	L	H	a	s	kg/100
RS RGA-PP-0-4	906.1000.004	-	-	28.0	27.0	0.0	0.60	0.990
RS RGA-PP-0-6	906.1000.006	-	-	28.0	27.0	0.0	0.60	0.850
RS RGA-PP-0-6.4	906.1000.007	1/4	-	28.0	27.0	0.0	0.60	1.020
RS RGA-PP-0-8	906.1000.008	5/16	-	28.0	27.0	0.0	0.60	0.950
RS RGA-PP-0-9.5	906.1000.009	3/8	-	28.0	27.0	0.0	0.60	0.850
RS RGA-PP-0-10	906.1000.010	-	G 1/8	28.0	27.0	0.0	0.60	0.940
RS RGA-PP-0-12	906.1000.012	-	-	28.0	27.0	0.0	0.60	0.890
RS RGA-PP-1-6	906.1000.106	-	-	34.0	27.0	20.0	0.60	1.360
RS RGA-PP-1-6.4	906.1000.107	1/4	-	34.0	27.0	20.0	0.60	1.190
RS RGA-PP-1-8	906.1000.108	5/16	-	34.0	27.0	20.0	0.60	1.230
RS RGA-PP-1-9.5	906.1000.109	3/8	-	34.0	27.0	20.0	0.60	1.340
RS RGA-PP-1-10	906.1000.110	-	G 1/8	34.0	27.0	20.0	0.60	1.160
RS RGA-PP-1-12	906.1000.112	-	-	34.0	27.0	20.0	0.60	1.300
RS RGA-PP-2-12.7	906.1000.212	1/2	-	42.0	33.0	26.0	0.80	1.740
RS RGA-PP-2-13.5	906.1000.213	-	G 1/4	42.0	33.0	26.0	0.80	1.690
RS RGA-PP-2-14	906.1000.214	-	-	42.0	33.0	26.0	0.80	1.650
RS RGA-PP-2-15	906.1000.215	-	-	42.0	33.0	26.0	0.80	1.610
RS RGA-PP-2-16	906.1000.216	5/8	-	42.0	33.0	26.0	0.80	1.640
RS RGA-PP-2-17.2	906.1000.217	-	G 3/8	42.0	33.0	26.0	0.80	1.540
RS RGA-PP-2-18	906.1000.218	-	-	42.0	33.0	26.0	0.80	1.500
RS RGA-PP-3-19	906.1000.319	3/4	-	49.0	35.0	33.0	1.00	1.770
RS RGA-PP-3-20	906.1000.320	-	-	49.0	35.0	33.0	1.00	1.830
RS RGA-PP-3-21.3	906.1000.321	-	G 1/2	49.0	35.0	33.0	1.00	1.870
RS RGA-PP-3-22	906.1000.322	-	-	49.0	35.0	33.0	1.00	1.840
RS RGA-PP-3-23	906.1000.323	-	-	49.0	35.0	33.0	1.00	1.810
RS RGA-PP-3-25	906.1000.325	-	-	49.0	35.0	33.0	1.00	1.940
RS RGA-PP-3-25.4	906.1000.326	1	-	49.0	35.0	33.0	1.00	1.700
RS RGA-PP-4-26.9	906.1000.426	-	G 3/4	59.0	42.0	40.0	1.20	2.700
RS RGA-PP-4-28	906.1000.428	-	-	59.0	42.0	40.0	1.20	2.590
RS RGA-PP-4-30	906.1000.430	-	-	59.0	42.0	40.0	1.20	2.530
RS RGA-PP-5-32	906.1000.532	1 1/4	-	71.0	58.0	52.0	1.20	4.780
RS RGA-PP-5-33.7	906.1000.533	-	G 1	71.0	58.0	52.0	1.20	4.760
RS RGA-PP-5-35	906.1000.535	-	-	71.0	58.0	52.0	1.20	4.780
RS RGA-PP-5-38	906.1000.538	1 1/2	-	71.0	58.0	52.0	1.20	4.320
RS RGA-PP-5-40	906.1000.540	-	-	71.0	58.0	52.0	1.20	4.250
RS RGA-PP-5-42	906.1000.542	-	G 1 1/4	71.0	58.0	52.0	1.20	4.030

Fortsetzung nächste Seite

Suite à la prochaine page

Continued on next page

d=Rohrassen-ø
 d (")=d=Rohrassen-ø zoll
 G=Rohr-Nennweite
 S=Schellengröße

d=ø extérieur du tube
 d (")=ø extérieur du tube pouce
 G=largeur nominale du tube
 S=dimension du collier

d=tube outside diameter
 d (")=tube outside diameter inch
 G=tube nominal width
 S=size of clamp

Schellenkörper

PP, Serie A

Corps de collier

PP, série A

Clamp body

PP, series A

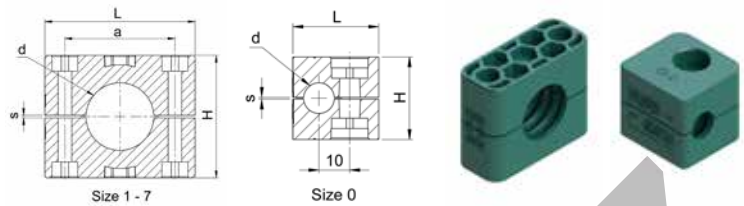

RS RGA-PP

Type -S-d	Mat.-Nr.	d (")	G	L	H	a	s	kg/100
RS RGA-PP-6-44.5	906.1000.644	1 3/4	-	86.0	66.0	66.0	1.20	5.970
RS RGA-PP-6-45	906.1000.645	-	-	86.0	66.0	66.0	1.20	5.940
RS RGA-PP-6-48	906.1000.648	-	G 1 1/2	86.0	66.0	66.0	1.20	5.600
RS RGA-PP-6-50	906.1000.650	-	-	86.0	66.0	66.0	1.20	5.510
RS RGA-PP-6-50.8	906.1000.651	2	-	86.0	66.0	66.0	1.20	5.330
RS RGA-PP-6-52	906.1000.652	-	-	86.0	66.0	66.0	1.20	5.180
RS RGA-PP-6-54	906.1000.654	-	-	86.0	66.0	66.0	1.20	5.840
RS RGA-PP-6-55	906.1000.655	-	-	86.0	66.0	66.0	1.20	4.750
RS RGA-PP-6-57	906.1000.657	-	-	86.0	66.0	66.0	1.20	4.520
RS RGA-PP-7-57.2	906.1000.757	2 1/4	-	121.0	93.6	94.0	1.60	13.600
RS RGA-PP-7-60.3	906.1000.760	-	G 2	121.0	93.6	94.0	1.60	13.650
RS RGA-PP-7-63.5	906.1000.763	2 1/2	-	121.0	93.6	94.0	1.60	12.550
RS RGA-PP-7-70	906.1000.770	2 3/4	-	121.0	93.6	94.0	1.60	12.100
RS RGA-PP-7-73	906.1000.773	-	-	121.0	93.6	94.0	1.60	14.000
RS RGA-PP-7-76.1	906.1000.776	3	G 2 1/2	121.0	93.6	94.0	1.60	10.950

Lieferung nur in Einheitspackungen:
Größen 0 bis 6 = Beutel à 25 Stk.
Größe 7 = Beutel à 10 Stk.

Livable seulement dans des unités
d'emballage:
Dimensions 0 à 6 = Sachets de 25 pcs.
Dimension 7 = Sachets de 10 pcs.

Delivery in packing units only:
Sizes 0 to 6 = Bags with 25 pcs.
Size 7 = Bags with 10 pcs.

Schellenkörper

PA, Serie A

Corps de collier

PA, série A

Clamp body

PA, series A

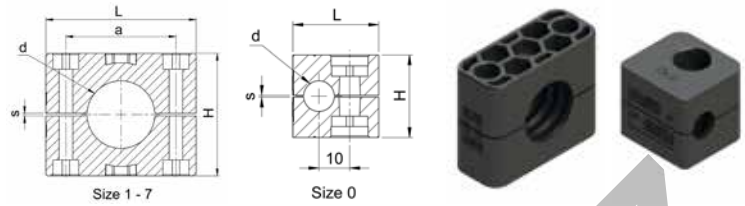
RS RGA-PA

Type -S-d	Mat.-Nr.	d (")	G	L	H	a	s	kg/100
RS RGA-PA-0-4	906.2000.004	-	-	28.0	27.0	0.0	0.60	1.300
RS RGA-PA-0-6	906.2000.006	-	-	28.0	27.0	0.0	0.60	1.200
RS RGA-PA-0-6.4	906.2000.007	1/4	-	28.0	27.0	0.0	0.60	0.900
RS RGA-PA-0-8	906.2000.008	5/16	-	28.0	27.0	0.0	0.60	1.200
RS RGA-PA-0-9.5	906.2000.009	3/8	-	28.0	27.0	0.0	0.60	0.900
RS RGA-PA-0-10	906.2000.010	-	G 1/8	28.0	27.0	0.0	0.60	1.150
RS RGA-PA-0-12	906.2000.012	-	-	28.0	27.0	0.0	0.60	1.110
RS RGA-PA-1-6	906.2000.106	-	-	34.0	27.0	20.0	0.60	1.660
RS RGA-PA-1-6.4	906.2000.107	1/4	-	34.0	27.0	20.0	0.60	1.600
RS RGA-PA-1-8	906.2000.108	5/16	-	34.0	27.0	20.0	0.60	1.520
RS RGA-PA-1-9.5	906.2000.109	3/8	-	34.0	27.0	20.0	0.60	1.670
RS RGA-PA-1-10	906.2000.110	-	G 1/8	34.0	27.0	20.0	0.60	1.620
RS RGA-PA-1-12	906.2000.112	-	-	34.0	27.0	20.0	0.60	1.360
RS RGA-PA-2-12.7	906.2000.212	1/2	-	42.0	33.0	26.0	0.80	2.200
RS RGA-PA-2-13.5	906.2000.213	-	G 1/4	42.0	33.0	26.0	0.80	2.150
RS RGA-PA-2-14	906.2000.214	-	-	42.0	33.0	26.0	0.80	1.960
RS RGA-PA-2-15	906.2000.215	-	-	42.0	33.0	26.0	0.80	2.010
RS RGA-PA-2-16	906.2000.216	5/8	-	42.0	33.0	26.0	0.80	1.890
RS RGA-PA-2-17.2	906.2000.217	-	G 3/8	42.0	33.0	26.0	0.80	2.100
RS RGA-PA-2-18	906.2000.218	-	-	42.0	33.0	26.0	0.80	1.820
RS RGA-PA-3-19	906.2000.319	3/4	-	49.0	35.0	33.0	1.00	2.430
RS RGA-PA-3-20	906.2000.320	-	-	49.0	35.0	33.0	1.00	2.630
RS RGA-PA-3-21.3	906.2000.321	-	G 1/2	49.0	35.0	33.0	1.00	2.390
RS RGA-PA-3-22	906.2000.322	-	-	49.0	35.0	33.0	1.00	2.310
RS RGA-PA-3-23	906.2000.323	-	-	49.0	35.0	33.0	1.00	2.160
RS RGA-PA-3-25	906.2000.325	-	-	49.0	35.0	33.0	1.00	2.090
RS RGA-PA-3-25.4	906.2000.326	1	-	49.0	35.0	33.0	1.00	2.080
RS RGA-PA-4-26.9	906.2000.426	-	G 3/4	59.0	42.0	40.0	1.20	3.400
RS RGA-PA-4-28	906.2000.428	-	-	59.0	42.0	40.0	1.20	3.210
RS RGA-PA-4-30	906.2000.430	-	-	59.0	42.0	40.0	1.20	3.140
RS RGA-PA-5-32	906.2000.532	1 1/4	-	71.0	58.0	52.0	1.20	5.900
RS RGA-PA-5-33.7	906.2000.533	-	G 1	71.0	58.0	52.0	1.20	5.570
RS RGA-PA-5-35	906.2000.535	-	-	71.0	58.0	52.0	1.20	5.640
RS RGA-PA-5-38	906.2000.538	1 1/2	-	71.0	58.0	52.0	1.20	5.390
RS RGA-PA-5-40	906.2000.540	-	-	71.0	58.0	52.0	1.20	5.030
RS RGA-PA-5-42	906.2000.542	-	G 1 1/4	71.0	58.0	52.0	1.20	4.750

Fortsetzung nächste Seite

Suite à la prochaine page

Continued on next page

Schellenkörper

PA, Serie A

Corps de collier

PA, série A

Clamp body

PA, series A

RS RGA-PA

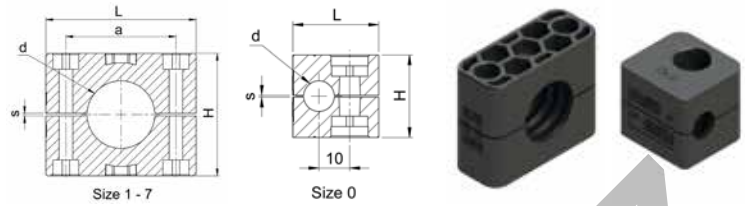

Type -S-d	Mat.-Nr.	d (")	G	L	H	a	s	kg/100
RS RGA-PA-6-44.5	906.2000.644	1 3/4	-	86.0	66.0	66.0	1.20	7.500
RS RGA-PA-6-45	906.2000.645	-	-	86.0	66.0	66.0	1.20	7.500
RS RGA-PA-6-48	906.2000.648	-	G 1 1/2	86.0	66.0	66.0	1.20	7.950
RS RGA-PA-6-50	906.2000.650	-	-	86.0	66.0	66.0	1.20	6.450
RS RGA-PA-6-50.8	906.2000.651	2	-	86.0	66.0	66.0	1.20	6.430
RS RGA-PA-6-52	906.2000.652	-	-	86.0	66.0	66.0	1.20	7.440
RS RGA-PA-6-54	906.2000.654	-	-	86.0	66.0	66.0	1.20	6.150
RS RGA-PA-6-55	906.2000.655	-	-	86.0	66.0	66.0	1.20	7.500
RS RGA-PA-6-57	906.2000.657	-	-	86.0	66.0	66.0	1.20	7.500
RS RGA-PA-7-57.2	906.2000.757	2 1/4	-	121.0	93.6	94.0	1.60	17.200
RS RGA-PA-7-60.3	906.2000.760	-	G 2	121.0	93.6	94.0	1.60	16.100
RS RGA-PA-7-63.5	906.2000.763	2 1/2	-	121.0	93.6	94.0	1.60	16.300
RS RGA-PA-7-70	906.2000.770	2 3/4	-	121.0	93.6	94.0	1.60	14.000
RS RGA-PA-7-73	906.2000.773	-	-	121.0	93.6	94.0	1.60	14.000
RS RGA-PA-7-76.1	906.2000.776	3	G 2 1/2	121.0	93.6	94.0	1.60	14.000

Lieferung nur in Einheitspackungen:
Größen 0 bis 6 = Beutel à 25 Stk.
Größe 7 = Beutel à 10 Stk.

Livable seulement dans des unités
d'emballage:
Dimensions 0 à 6 = Sachets de 25 pcs.
Dimension 7 = Sachets de 10 pcs.

Delivery in packing units only:
Sizes 0 to 6 = Bags with 25 pcs.
Size 7 = Bags with 10 pcs.

Schellenkörper

PA flammhemmend, Serie A

Corps de collier

PA ignifugé, série A

Clamp body

PA flame retardant, series A

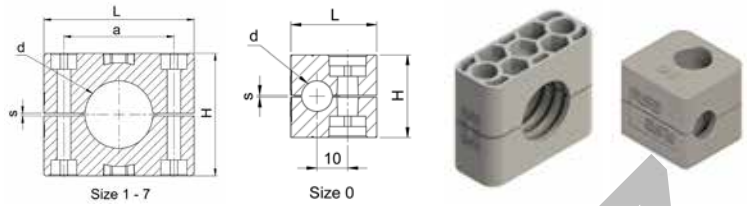

RS RGA PA F

Type -S-d	Mat.-Nr.	d (")	G	L	H	a	s	kg/100
RS RGA-PA-0-10 F	906.2000.010.F	-	G 1/8	28.0	27.0	0.0	0.60	1.150
RS RGA-PA-1-8 F	906.2000.108.F	5/16	-	34.0	27.0	20.0	0.60	1.520
RS RGA-PA-1-10 F	906.2000.110.F	-	G 1/8	34.0	27.0	20.0	0.60	1.620
RS RGA-PA-2-18 F	906.2000.218.F	-	-	42.0	33.0	26.0	0.80	1.820
RS RGA-PA-3-19 F	906.2000.319.F	3/4	-	49.0	35.0	33.0	1.00	2.430
RS RGA-PA-3-22 F	906.2000.322.F	-	-	49.0	35.0	33.0	1.00	2.310

Lieferung nur in Einheitspackungen = Beutel à 25 Stk.

Livable seulement dans des unités d'emballage = sachets de 25 pcs.

Delivery in packing units only = bags with 25 pcs.

d=Rohrussen-ø
 d (")=d=Rohrussen-ø zoll
 G=Rohr-Nennweite
 S=Schellengröße

d=ø extérieur du tube
 d (")=ø extérieur du tube pouce
 G=largeur nominale du tube
 S=dimension du collier

d=tube outside diameter
 d (")=tube outside diameter inch
 G=tube nominal width
 S=size of clamp

Schellenkörper

Aluminium, Serie A

Corps de collier

aluminium, série A

Clamp body

aluminium, series A

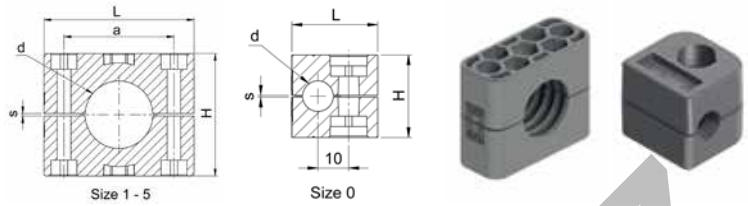
RS RGA-AL

Type -S-d	Mat.-Nr.	d (")	G	L	H	a	s	kg/100
RS RGA-AL-0-10	906.7000.010	-	G 1/8	28.0	27.0	0.0	0.60	4.020
RS RGA-AL-0-12	906.7000.012	-	-	28.0	27.0	0.0	0.60	3.800
RS RGA-AL-1-6	906.7000.106	-	-	34.0	27.0	20.0	0.60	3.750
RS RGA-AL-1-8	906.7000.108	5/16	-	34.0	27.0	20.0	0.60	3.420
RS RGA-AL-1-10	906.7000.110	-	G 1/8	34.0	27.0	20.0	0.60	3.310
RS RGA-AL-1-12	906.7000.112	-	-	34.0	27.0	20.0	0.60	3.160
RS RGA-AL-2-15	906.7000.215	-	-	42.0	33.0	26.0	0.80	5.550
RS RGA-AL-2-18	906.7000.218	-	-	42.0	33.0	26.0	0.80	5.300
RS RGA-AL-3-22	906.7000.322	-	-	49.0	35.0	33.0	1.00	5.820
RS RGA-AL-3-25	906.7000.325	-	-	49.0	35.0	33.0	1.00	5.380
RS RGA-AL-4-28	906.7000.428	-	-	59.0	42.0	40.0	1.20	7.510
RS RGA-AL-5-35	906.7000.535	-	-	71.0	58.0	52.0	1.20	14.130
RS RGA-AL-5-42	906.7000.542	-	G 1 1/4	71.0	58.0	52.0	1.20	12.150

Lieferung nur in Einheitspackungen = Beutel à 25 Stk.

Livrable seulement dans des unités d'emballage = sachets de 25 pcs.

Delivery in packing units only = bags with 25 pcs.

Schellenkörper

PP, Serie B (Zweirohrschellen)

Corps de collier

PP, série B (colliers à deux tubes)

Clamp body

PP, series B (twin-tube clamp)

RS RGB-PP

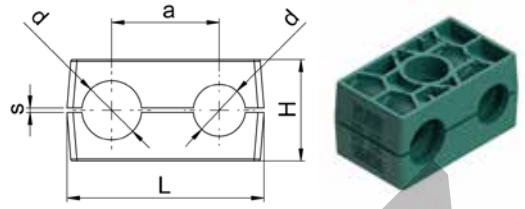

Type -S -d	Mat.-Nr.	G	L	H	a	s	kg/100
RS RGB-PP-1-6	916.1000.106	-	36.0	27.0	20.0	1.00	1.330
RS RGB-PP-1-10	916.1000.110	G 1/8	36.0	27.0	20.0	1.00	1.230
RS RGB-PP-1-12	916.1000.112	-	36.0	27.0	20.0	1.00	1.130

Lieferung nur in Einheitspackungen = Beutel à 25 Stk.

Livable seulement dans des unités d'emballage = sachets de 25 pcs.

Delivery in packing units only = bags with 25 pcs.

d=Rohrussen-ø
 d (")=d=Rohrussen-ø zoll
 G=Rohr-Nennweite
 S=Schellengröße

d=ø extérieur du tube
 d (")=ø extérieur du tube pouce
 G=largeur nominale du tube
 S=dimension du collier

d=tube outside diameter
 d (")=tube outside diameter inch
 G=tube nominal width
 S=size of clamp

Schellenkörper

PA, Serie B (Zweiroherschellen)

Corps de collier

PA, série B (colliers à deux tubes)

Clamp body

PA, series B (twin-tube clamp)

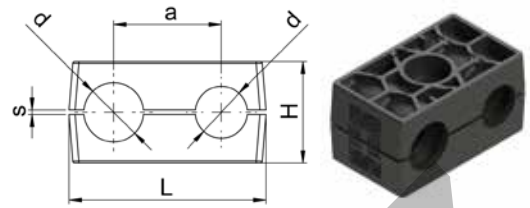

RS RGB-PA

Type -S-d	Mat.-Nr.	G	L	H	a	s	kg/100
RS RGB-PA-1-6	916.2000.106	-	36.0	27.0	20.0	1.00	1.680
RS RGB-PA-1-10	916.2000.110	G 1/8	36.0	27.0	20.0	1.00	1.540
RS RGB-PA-2-15	916.2000.215	-	53.0	27.4	29.0	1.20	2.160
RS RGB-PA-2-18	916.2000.218	-	53.0	27.4	29.0	1.20	1.800
RS RGB-PA-4-28	916.2000.428	-	82.0	42.0	52.0	2.00	3.980
RS RGB-PA-5-35	916.2000.535	-	106.0	54.0	56.0	2.00	7.200

Lieferung nur in Einheitspackungen = Beutel à 25 Stk.

Livable seulement dans des unités d'emballage = sachets de 25 pcs.

Delivery in packing units only = bags with 25 pcs.

KONVARIANT

d=Rohrussen-ø
 d (")=d=Rohrussen-ø zoll
 G=Rohr-Nennweite
 S=Schellengröße

d=ø extérieur du tube
 d (")=ø extérieur du tube pouce
 G=largeur nominale du tube
 S=dimension du collier

d=tube outside diameter
 d (")=tube outside diameter inch
 G=tube nominal width
 S=size of clamp

Schellenkörper

PA flammhemmend, Serie B (Zweirohrsellen)

Corps de collier

PA ignifugé, série B (colliers à deux tubes)

Clamp body

PA flame retardant, series B (twin-tube clamp)

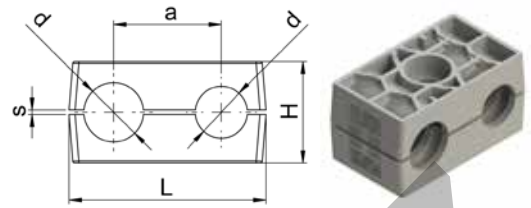

RS RGB-PA F

Type -S-d	Mat.-Nr.	d (")	G	L	H	a	s	kg/100
RS RGB-PA-1-8 F	916.2000.108.F	5/16	-	36.0	27.0	20.0	1.00	1.540
RS RGB-PA-1-10 F	916.2000.110.F	-	G 1/8	36.0	27.0	20.0	1.00	1.540
RS RGB-PA-1-12 F	916.2000.112.F	-	-	36.0	27.0	20.0	1.00	1.600
RS RGB-PA-2-15 F	916.2000.215.F	-	-	53.0	27.4	29.0	1.20	2.160
RS RGB-PA-4-28 F	916.2000.428.F	-	-	82.0	42.0	52.0	2.00	3.980
RS RGB-PA-5-35 F	916.2000.535.F	-	-	106.0	54.0	56.0	2.00	7.200

Lieferung nur in Einheitspackungen = Beutel à 25 Stk.

Livable seulement dans des unités d'emballage = sachets de 25 pcs.

Delivery in packing units only = bags with 25 pcs.

d=Rohrussen-ø
d (")=d=Rohrussen-ø zoll
G=Rohr-Nennweite
S=Schellengröße

d=ø extérieur du tube
d (")=ø extérieur du tube pouce
G=largeur nominale du tube
S=dimension du collier

d=tube outside diameter
d (")=tube outside diameter inch
G=tube nominal width
S=size of clamp

Anschweisplatte kurz

Stahl phosphatiert, Serie A

Plaque à souder courte

acier phosphaté, série A

Weld-on plate short

steel phosphatized, series A

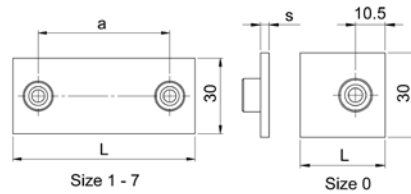

RS AKZ1A-SB

Type-S	Mat.-Nr.	L	a	s	kg/100
RS AKZ1A-SB-0	946.3108.000	30.0	0.0	3.00	2.400
RS AKZ1A-SB-1	946.3108.100	36.0	20.0	3.00	3.200
RS AKZ1A-SB-2	946.3108.200	42.0	26.0	3.00	3.600
RS AKZ1A-SB-3	946.3108.300	50.0	33.0	3.00	4.100
RS AKZ1A-SB-4	946.3108.400	59.0	40.0	3.00	4.800
RS AKZ1A-SB-5	946.3108.500	72.0	52.0	3.00	5.400
RS AKZ1A-SB-6	946.3108.600	88.0	66.0	3.00	6.000
RS AKZ1A-SB-7	946.3108.700	122.0	94.0	5.00	14.000

Anschweisplatte kurz

Edelstahl 1.4571/1.4401, Serie A

Plaque à souder courte

acier inoxydable 1.4571/1.4401, série A

Weld-on plate short

stainless steel 1.4571/1.4401, series A

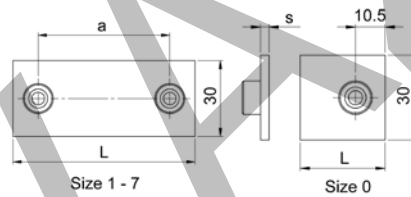

RS AKZ2A-E1

Type-S	Mat.-Nr.	L	a	s	kg/100
RS AKZ2A-E1-0	946.5118.000	30.0	0.0	3.00	2.200
RS AKZ2A-E1-1	946.5118.100	36.0	20.0	3.00	2.500
RS AKZ2A-E1-2	946.5118.200	42.0	26.0	3.00	2.900
RS AKZ2A-E1-3	946.5118.300	50.0	33.0	3.00	3.500
RS AKZ2A-E1-4	946.5118.400	59.0	40.0	3.00	4.000
RS AKZ2A-E1-5	946.5118.500	72.0	52.0	3.00	4.900
RS AKZ2A-E1-6	946.5118.600	88.0	66.0	3.00	6.300
RS AKZ2A-E1-7	946.5118.700	122.0	94.0	5.00	14.600

Lieferung nur in Einheitspackungen:
Größen 0 bis 6 = Beutel à 25 Stk.
Größe 7 = Beutel à 10 Stk.

Livable seulement dans des unités
d'emballage:
Dimensions 0 à 6 = Sachets de 25 pcs.
Dimension 7 = Sachets de 10 pcs.

Delivery in packing units only:
Sizes 0 to 6 = Bags with 25 pcs.
Size 7 = Bags with 10 pcs.

Anschweisplatte kurz

mit Verdrehsicherung, Edelstahl 1.4571/1.4401, Serie B

Plaque à souder courte

avec verrou de torsion, acier inoxydable 1.4571/1.4401, série B

Weld-on plate short

with torsion lock, stainless steel 1.4571/1.4401, series B

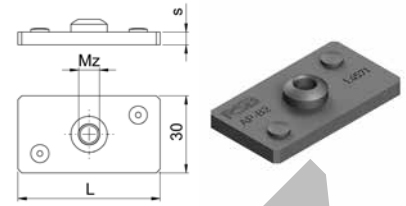

RS AKZ3B-E1

Type-S	Mat.-Nr.	Mz	L	s	kg/100
RS AKZ3B-E1-1	956.5118.100	M6	37.0	3.00	2.620
RS AKZ3B-E1-2	956.5118.200	M8	55.0	5.00	6.200
RS AKZ3B-E1-3	956.5118.300	M8	70.0	5.00	7.900
RS AKZ3B-E1-4	956.5118.400	M8	85.0	5.00	9.800
RS AKZ3B-E1-5	956.5118.500	M8	110.0	5.00	12.600

Lieferung nur in Einheitspackungen = Beutel à 25 Stk.

Livable seulement dans des unités d'emballage = sachets de 25 pcs.

Delivery in packing units only = bags with 25 pcs.

Deckplatte

Stahl verzinkt, Serie A

Plaque de couverture

acier zingué, série A

Cover plate

zinc-plated steel, series A

RS DPA-VZ

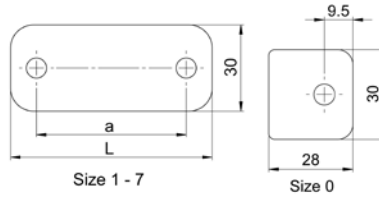

Type -S	Mat.-Nr.	L	a	kg/100
RS DPA-VZ-0	946.4130.000	28.0	0.0	1.700
RS DPA-VZ-1	946.4130.100	34.0	20.0	2.100
RS DPA-VZ-2	946.4130.200	40.0	26.0	2.500
RS DPA-VZ-3	946.4130.300	48.0	33.0	3.100
RS DPA-VZ-4	946.4130.400	57.0	40.0	3.700
RS DPA-VZ-5	946.4130.500	70.0	52.0	4.600
RS DPA-VZ-6	946.4130.600	86.0	66.0	5.700
RS DPA-VZ-7	946.4130.700	120.0	94.0	14.000

Deckplatte

Edelstahl 1.4571/1.4401, Serie A

Plaque de couverture

acier inoxydable 1.4571/1.4401, série A

Cover plate

stainless steel 1.4571/1.4401, series A

RS DPA-E1

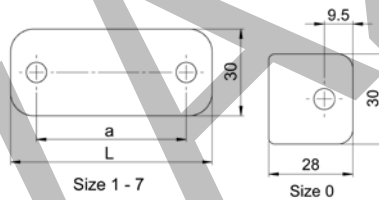

Type -S	Mat.-Nr.	L	a	kg/100
RS DPA-E1-0	946.5130.000	28.0	0.0	1.900
RS DPA-E1-1	946.5130.100	34.0	20.0	2.000
RS DPA-E1-2	946.5130.200	40.0	26.0	2.400
RS DPA-E1-3	946.5130.300	48.0	33.0	3.100
RS DPA-E1-4	946.5130.400	57.0	40.0	3.600
RS DPA-E1-5	946.5130.500	70.0	52.0	4.000
RS DPA-E1-6	946.5130.600	86.0	66.0	5.800
RS DPA-E1-7	946.5130.700	120.0	94.0	13.400

Lieferung nur in Einheitspackungen:
Größen 0 bis 6 = Beutel à 25 Stk.
Größe 7 = Beutel à 10 Stk.

Livable seulement dans des unités
d'emballage:
Dimensions 0 à 6 = Sachets de 25 pcs.
Dimension 7 = Sachets de 10 pcs.

Delivery in packing units only:
Sizes 0 to 6 = Bags with 25 pcs.
Size 7 = Bags with 10 pcs.

Deckplatte

Edelstahl 1.4571/1.4401, Serie B

Plaque de couverture

acier inoxydable 1.4571/1.4401, série B

Cover plate

stainless steel 1.4571/1.4401, series B

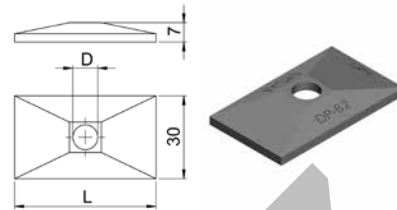
RS DPB-E1

Type-S	Mat.-Nr.	L	kg/100
RS DPB-E1-1	956.5130.100	34.0	2.300
RS DPB-E1-2	956.5130.200	51.0	3.400
RS DPB-E1-3	956.5130.300	64.0	4.400
RS DPB-E1-4	956.5130.400	78.0	5.300
RS DPB-E1-5	956.5130.500	102.0	7.200

Lieferung nur in Einheitspackungen = Beutel à 25 Stk.

Livrable seulement dans des unités d'emballage = sachets de 25 pcs.

Delivery in packing units only = bags with 25 pcs.

Sechskantschraube

Stahl verzinkt, Serie A

Vis à tête hexagonale

acier zingué, série A

Hexagon screw

zinc-plated steel, series A

RS SSA-VZ

Type -S	Mat.-Nr.	Mz	L	kg/100
RS SSA-VZ-0/1	946.4210.000	M6	30.0	0.800
RS SSA-VZ-2	946.4210.200	M6	35.0	0.900
RS SSA-VZ-3	946.4210.300	M6	40.0	1.000
RS SSA-VZ-4	946.4210.400	M6	45.0	1.200
RS SSA-VZ-5	946.4210.500	M6	60.0	1.400
RS SSA-VZ-6	946.4210.600	M6	70.0	1.800
RS SSA-VZ-7	946.4210.700	M6	100.0	1.900

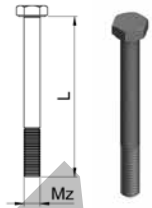

Sechskantschraube

Edelstahl 1.4571/1.4401, Serie A

Vis à tête hexagonale

acier inoxydable 1.4571/1.4401, série A

Hexagon screw

stainless steel 1.4571/1.4401, series A

RS SSA-E1

Type -S	Mat.-Nr.	Mz	L	kg/100
RS SSA-E1-0/1	946.5210.000	M6	30.0	0.800
RS SSA-E1-2	946.5210.200	M6	35.0	0.900
RS SSA-E1-3	946.5210.300	M6	40.0	1.000
RS SSA-E1-4	946.5210.400	M6	45.0	1.200
RS SSA-E1-5	946.5210.500	M6	60.0	1.500
RS SSA-E1-6	946.5210.600	M6	70.0	1.800
RS SSA-E1-7	946.5210.700	M6	100.0	2.000

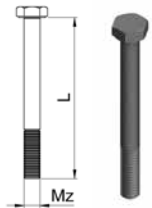

Lieferung nur in Einheitspackungen:

Größen 0 bis 6 = Beutel à 50 Stk.

Größe 7 = Beutel à 20 Stk.

Livable seulement dans des unités

d'emballage:

Dimensions 0 à 6 = Sachets de 50 pcs.

Dimension 7 = Sachets de 20 pcs.

Delivery in packing units only:

Sizes 0 to 6 = Bags with 50 pcs.

Size 7 = Bags with 20 pcs.

Sechskantschraube

Edelstahl 1.4571/1.4401, Serie B

Vis à tête hexagonale

acier inoxydable 1.4571/1.4401, série B

Hexagon screw

stainless steel 1.4571/1.4401, series B

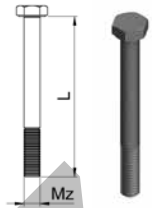

RS SSB-E1

Type-S	Mat.-Nr.	Mz	L	kg/100
RS SSB-E1-1	956.5210.100	M6	35.0	0.900
RS SSB-E1-2	956.5210.200	M8	35.0	1.900
RS SSB-E1-3	956.5210.300	M8	45.0	2.300
RS SSB-E1-4	956.5210.400	M8	50.0	2.500
RS SSB-E1-5	956.5210.500	M8	60.0	2.900

Lieferung nur in Einheitspackungen:

Grösse 1 = Beutel à 50 Stk.

Grösse 2-5 = Beutel à 25 Stk.

Livable seulement dans des unités d'emballage:

Dimension 1 = Sachets de 50 pcs.

Dimension 2 - 5 = Sachets de 25 pcs.

Delivery in packing units only:

Size 1 = Bags with 50 pcs.

Size 2 - 5 = Bags with 25 pcs.

Innensechskantschraube

Stahl verzinkt, Serie A

Vis à six pans creux

acier zingué, série A

Hexagon socket screw

zinc-plated steel, series A

RS ISA-VZ

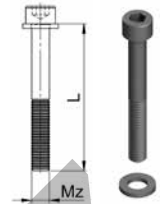

Type-S	Mat.-Nr.	Mz	L	kg/100
RS ISA-VZ-01	946.4220.000	M6	20.0	0.600
RS ISA-VZ-2	946.4220.200	M6	25.0	0.700
RS ISA-VZ-3	946.4220.300	M6	30.0	0.800
RS ISA-VZ-4	946.4220.400	M6	35.0	1.000
RS ISA-VZ-5	946.4220.500	M6	50.0	1.200
RS ISA-VZ-6	946.4220.600	M6	60.0	1.400
RS ISA-VZ-7	946.4220.700	M6	90.0	1.800

Innensechskantschraube

Edelstahl 1.4571/1.4401, Serie A

Vis à six pans creux

acier inoxydable 1.4571/1.4401, série A

Hexagon socket screw

stainless steel 1.4571/1.4401, series A

RS ISA-E1

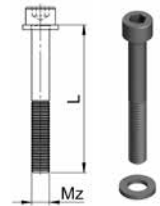

Type-S	Mat.-Nr.	Mz	L	kg/100
RS ISA-E1-01	946.5220.000	M6	20.0	0.600
RS ISA-E1-2	946.5220.200	M6	25.0	0.700
RS ISA-E1-3	946.5220.300	M6	30.0	0.800
RS ISA-E1-4	946.5220.400	M6	35.0	1.000
RS ISA-E1-5	946.5220.500	M6	50.0	1.200
RS ISA-E1-6	946.5220.600	M6	60.0	1.400
RS ISA-E1-7	946.5220.700	M6	90.0	1.800

Lieferung nur in Einheitspackungen:

Größen 0 bis 6 = Beutel à 50 Stk.

Größe 7 = Beutel à 20 Stk.

Livable seulement dans des unités

d'emballage:

Dimensions 0 à 6 = Sachets de 50 pcs.

Dimension 7 = Sachets de 20 pcs.

Delivery in packing units only:

Sizes 0 to 6 = Bags with 50 pcs.

Size 7 = Bags with 20 pcs.

Innensechskantschraube

Edelstahl 1.4571/1.4401, Serie B

Vis à six pans creux

acier inoxydable 1.4571/1.4401, série B

Hexagon socket screw

stainless steel 1.4571/1.4401, series B

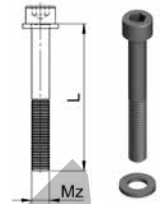

RS ISB-E1

Type-S	Mat.-Nr.	Mz	L	kg/100
RS ISB-E1-1	956.5220.100	M6	35.0	1.100
RS ISB-E1-2	956.5220.200	M8	35.0	1.800
RS ISB-E1-3	956.5220.300	M8	45.0	2.200
RS ISB-E1-4	956.5220.400	M8	50.0	2.900
RS ISB-E1-5	956.5220.500	M8	60.0	3.300

Lieferung nur in Einheitspackungen:

Grösse 1 = Beutel à 50 Stk.

Grösse 2-5 = Beutel à 25 Stk.

Livable seulement dans des unités
d'emballage:

Dimension 1 = Sachets de 50 pcs.

Dimension 2 - 5 = Sachets de 25 pcs.

Delivery in packing units only:

Size 1 = Bags with 50 pcs.

Size 2 - 5 = Bags with 25 pcs.

Aufbauschraube

Edelstahl 1.4571/14401, Serie A

Vis d'empilage

acier inoxydable 1.4571/14401, série A

Stacking screw

stainless steel 1.4571/14401, serie A

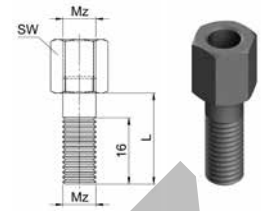

RS ASA-E1

Type-S	Mat.-Nr.	Mz	L	kg/100
RS ASA-E1-01	946.5240.000	M6	20.0	1.300
RS ASA-E1-2	946.5240.200	M6	25.0	1.300
RS ASA-E1-3	946.5240.300	M6	28.0	1.450
RS ASA-E1-4	946.5240.400	M6	34.0	1.600
RS ASA-E1-5	946.5240.500	M6	50.0	2.000
RS ASA-E1-6	946.5240.600	M6	60.0	2.200

Lieferung nur in Einheitspackungen = Beutel à 25 Stk.

Livrabile seulement dans des unités d'emballage = sachets de 25 pcs.

Delivery in packing units only = bags with 25 pcs.

Tragschiene

Stahl blank, Serie A

Rail de support

acier, série A

Mounting rail

steel, series A

RSTS-SB

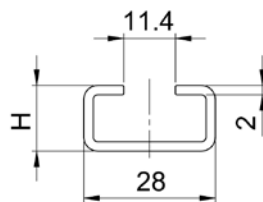

Type	Mat.-Nr.	L	H	kg/m
RS TS11A-SB-1m	946.4140.111	1000.0	11.0	0.866

Tragschiene

Edelstahl 1.4571/1.4401, Serie A

Rail de support

acier inoxydable 1.4571/1.4401, série A

Mounting rail

stainless steel 1.4571/1.4401, series A

RSTS-E1

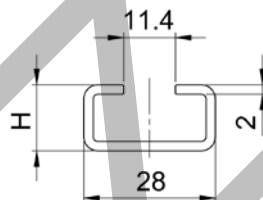

Type	Mat.-Nr.	L	H	kg/m
RS TS11A-E1-1m	946.5140.111	1000.0	11.0	0.862

Tragschienenmutter

Stahl verzinkt, Serie A

Écrou pour rail de support

acier zingué, série A

Rail nut

zinc-plated steel, series A

RS TMA-VZ/TMVA-VZ

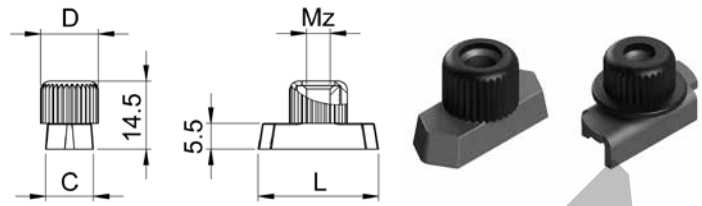

Type	Mat.-Nr.	Mz	L	C	D	kg/100
RS TMA-VZ	946.4160.000	M6	25.4	10.4	12.0	1.200
RS TMVA-VZ	946.4170.000	M6	24.9	10.5	12.0	0.700

Tragschienenmutter

Edelstahl 1.4571/1.4401, Serie A

Écrou pour rail de support

acier inoxydable 1.4571/1.4401, série A

Rail nut

stainless steel 1.4571/1.4401, series A

RS TMA-E1/TMVA-E1

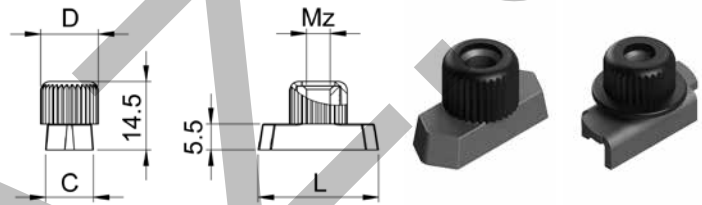

Type	Mat.-Nr.	Mz	L	C	D	kg/100
RS TMA-E1	946.5160.000	M6	25.4	10.4	12.0	1.508
RS TMVA-E1	946.5170.000	M6	24.9	10.5	12.0	0.940

Typ TMVA mit Verlusicherung.

Der grosse Flansch der Gummikappe verhindert, dass die Tragschienenmutter während der Montage in die Schiene fällt, und hat zusätzlich eine schall- und vibrationsdämmende Funktion. Dadurch ist das System schnell und einfach zu montieren und zu justieren, auch bei vertikaler Installation.

Lieferung nur in Einheitspackungen à 50 Stk.

Type TMVA avec sécurité anti-perte.

La grande bride du capuchon en caoutchouc empêche l'écrou de rail de tomber pendant le montage dans le rail et a également une fonction insonorisante et anti-vibratoire. Il est ainsi facile de monter et d'ajuster rapidement et simplement le système, même en cas d'installation verticale.

Livable seulement dans des unités d'emballage de 50 pcs.

Type TMVA with loss protection.

The large flange of the rubber cap prevents the rail nut from falling into the rail during installation and acts also to absorb impacts and vibrations. This makes the system quick and easy to install and adjust, even in a vertical installation.

Delivery in packing units of 50 pcs. only

Tragschienenmutter

Edelstahl 1.4571/1.4401, Serie B

Écrou pour rail de support

acier inoxydable 1.4571/1.4401, série B

Rail nut

stainless steel 1.4571/1.4401, series B

RS TMB-E1

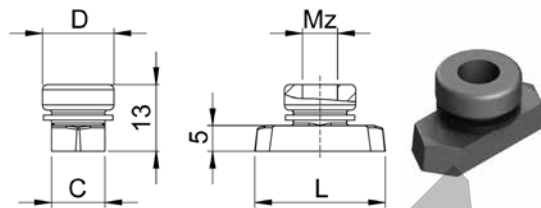

Type	Mat.-Nr.	Mz	L	C	D	kg/100
RS TMB-E1	956.5160.000	M8	25.4	10.4	14.0	1.300

Passend für Grösse 2 - 5. Lieferung in Einheitspackungen à 25 Stk.
Für Grösse 1 verwenden Sie bitte die Tragschienenmutter der Serie A.

Convient aux tailles 2 à 5. Livrable seulement dans des unités d'emballage de 25 pcs.
Pour la taille 1, veuillez utiliser l'écrou pour rail de support de la série A.

Suitable for size 2 - 5. Delivery in packing units of 25 pcs.
For size 1 please use rail nut of series A.

Montagemöglichkeiten
Possibilités de montage
Installation options
1) Montage auf Anschweisplatten

Die Anschweisplatten auf einer mit der Belastung abgestimmten Unterlage anschweißen. Hierbei ist auf die Ausrichtung der Schelle zu achten.

Die untere Schellenhälfte auf die Anschweisplatte klemmen, das Rohr einlegen, die zweite Schellenhälfte aufsetzen und mit den Schrauben festziehen. Auf die Vorspannung achten; Schellenhälften dürfen sich nach der Montage nicht berühren.

Nicht mit aufgesetzter Kunststoff-Schelle schweißen!

2) Montage auf Tragschienen

Die Tragschienen werden in Stücken zu 1 m geliefert.

Die Tragschiene anschweißen, Tragschienenmutter in die Schiene einführen und bis zum Anschlag drehen.

Die untere Schellenhälfte auf die Tragschienenmutter aufklemmen, das Rohr einlegen, die zweite Schellenhälfte aufsetzen und mit den Schrauben festziehen. Vor dem Festziehen der Schrauben ist eine Positionierung der Schelle möglich. Auf die Vorspannung achten; Schellenhälften dürfen sich nach der Montage nicht berühren.

1) Montage sur des embases

Souder les plaques à souder sur une base adaptée à la charge. L'alignement du collier doit être respecté.

Fixer la demi-coquille inférieure du collier sur l'embase, insérer le tube, ajuster la demi-coquille supérieure et serrer les vis. Attention à la pré-charge; les demi-coquilles ne doivent pas se toucher après le montage.

Ne pas souder lorsqu'un collier en plastique est en place!

2) Montage sur des rails

Les rails sont livrés en morceaux de 1 m. Souder les rails, introduire les écrous dans le rail et tourner jusqu'à la butée.

Placer la coquille inférieure du collier sur les écrous de rail, insérer le tube, ajuster la demi-coquille supérieure et serrer les vis. Avant de serrer les vis, il est possible de positionner le collier. Attention à la pré-charge; les demi-coquilles ne doivent pas se toucher après le montage.

1) Installation on weld-on plates

Weld the weld-on plates to a base suitable for the load. Here it is important to make sure the clamp is properly aligned.

Fasten the lower half of the clamp to the weld-on plate, insert the tube, set the second half of the clamp in place, and use screws to tighten the clamp. Pay attention to the pretension; clamp halves should not be touching after installation.

Do not weld with plastic clamps in place!

2) Installation on mounting rails

The mounting rails are delivered in pieces of 1 m in length.

Weld the mounting rail, place the rail nuts in the rail and turn until they stop.

Fasten the lower half of the clamp to the rail nuts, insert the tube, set the second half of the clamp in place, and use screws to tighten the clamp. The clamp can be positioned before the screws are tightened. Pay attention to the pretension; clamp halves should not be touching after installation.

1)



2)



Hinweis: Beim Einsatz von Innensechskantschrauben werden keine Deckplatten verwendet. Die Innensechskantschrauben liegen in der Schellenhälfte versenkt.

Note: Lors de l'utilisation des vis à six pans creux les plaques de couverture ne sont pas utilisés. Les vis à six pans creux sont encastrés dans le corps de collier.

Note: When using hexagon socket screws no cover plates are used. The hexagon socket screws are countersunk in the clamp body.

Technische Informationen

Informations techniques

Technical information

Schraubenanzugsmomente und axiale Rohrhaltekräfte

Die angegebenen Schraubenanzugsmomente und axialen Rohrhaltekräfte beziehen sich auf die jeweilige Montageart. Die axiale Rohrhaltekraft (gemäß DIN 3015 Teil 10) ist ein Mittelwert, ermittelt aus drei Versuchen bei +23 °C mit einem Stahlrohr nach DIN 2448 aus St 37, bei dem Haftreibung vorausgesetzt wird. Bei Belastung der Schelle in axialer Rohrrichtung mit der angegebenen Prüfkraft (F) gleitet das Rohr in der Schelle nicht.

1. Montage mit Sechskantschrauben und Deckplatten nach ISO 4014/4017 (DIN 931/933)

Befestigungsschraube für alle Typen M6

Couples de serrage des vis et forces de serrage axiales des tubes

Les couples de serrage des vis indiqués et les forces de serrage axiales se rapportent au type de montage respectif. La force de serrage axiale (conformément à DIN 3015 Partie 10) est une valeur moyenne, calculée sur la base de trois essais à +23 °C avec un tube en acier A37 conformément à DIN 2448 pour lequel on suppose une friction par adhérence. Si le collier est sollicité dans la direction axiale du tube avec la force d'essai donnée (F), le tube ne coulisse pas dans le collier.

1. Montage avec des vis à tête hexagonale et des plaques de couverture selon ISO 4014/4017 (DIN 931/933)

Vis de fixation pour tous les types M6

Screw tightening torques and axial tube holding power

The specified screw tightening torques and axial tube holding power are based on the respective type of installation. The axial tube holding power (pursuant to DIN 3015, Part 10) is a mean value, determined from three tests at +23 °C with a steel tube according to DIN 2448 made of St 37, where static friction is provided. The tube will not slide in the clamp when force is applied to the clamp in the axial tube direction at the specified test load (F).

1. Installation with hexagon screws and cover plates according to ISO 4014/4017 (DIN 931/933).

Retaining screw for all types M6

Grösse Taille Size	Anzugsdrehmoment Couple de serrage Tightening torque (Nm)	PP		PA		Aluminium	
		Rohrhaltekraft Force de serrage du tube Tube holding power F (kN)	Anzugsdrehmoment Couple de serrage Tightening torque (Nm)	Rohrhaltekraft Force de serrage du tube Tube holding power F (kN)	Anzugsdrehmoment Couple de serrage Tightening torque (Nm)	Rohrhaltekraft Force de serrage du tube Tube holding power F (kN)	
0	8	0.6	10	0.6	12	3.5	
1	8	1.1	10	0.7	12	4.2	
2	8	1.2	10	0.8	12	4.3	
3	8	1.4	10	1.6	12	4.8	
4	8	1.5	10	1.7	12	5.0	
5	8	1.9	10	2.0	12	7.3	
6	8	2.0	10	2.5	12	8.9	
7	8	2.3	10	3.2			

2. Montage mit Innensechskantschrauben, ohne Deckplatten, nach ISO 4762

Befestigungsschraube für alle Typen M6

2. Montage avec des vis à six pans creux, sans des plaques de couverture, selon ISO 4762

Vis de fixation pour tous les types M6

2. Installation with hexagon socket screws, without cover plates, according to ISO 4762

Retaining screw for all types M6

Grösse Taille Size	Anzugsdrehmoment Couple de serrage Tightening torque (Nm)	PP		PA		Aluminium	
		Rohrhaltekraft Force de serrage du tube Tube holding power F (kN)	Anzugsdrehmoment Couple de serrage Tightening torque (Nm)	Rohrhaltekraft Force de serrage du tube Tube holding power F (kN)	Anzugsdrehmoment Couple de serrage Tightening torque (Nm)	Rohrhaltekraft Force de serrage du tube Tube holding power F (kN)	
0		auf Anfrage / sur demande / on request					
1	2.0	0.45	2.5	0.55	12	4.2	
2	2.0	0.85	2.5	0.95	12	4.3	
3	2.0	0.60	2.5	0.65	12	4.8	
4	2.5	0.85	3.5	1.05	12	5.0	
5	2.5	1.30	3.5	1.40	12	7.3	
6	2.5	1.05	3.5	1.15	12	8.9	
7		auf Anfrage / sur demande / on request					

Empfohlener Schellenabstand
Ecart recommandé des colliers
Recommended clamp spacing

Rohraussendurchmesser (mm) Diamètre extérieur du tube (mm) Tube outer diameter (mm)	Schellenabstand A (m) Ecart du collier A (m) Clamping space A (m)
6.0 - 12.7	1.0
12.7 - 22.0	1.2
22.0 - 32.0	1.5
32.0 - 38.0	2.0
38.0 - 57.0	2.7
57.0 - 75.0	3.0
75.0 - 76.1	3.5

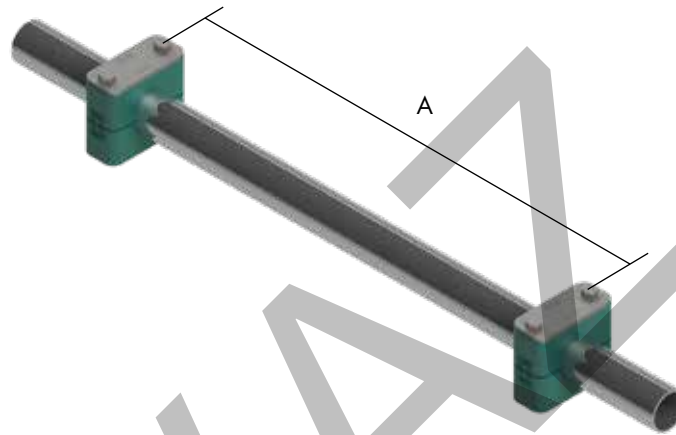
Rohrbogenmontage

Rohrbögen sind unmittelbar vor und hinter dem Bogen mit Rohrschellen zu befestigen.

Montage des coudes

Les coudes doivent être fixés avec les colliers de serrage immédiatement devant ou derrière le cintrage.

Tube elbow installation

Tube elbows should be fastened with tube clamps directly before and after the bend.



**Sichere Verbindungen
im Handumdrehen mit
SERTO Vormontage-
geräten**

**Des raccords fiables
en quelques secondes
avec les appareils de
prémontage SERTO**

**Safe connections in
next to no time with
the SERTO pre-assembly
tools**



Pneumatisches Vormontagegerät
SERTOtool für Durchmesser bis 10 mm

Appareil à prémontage pneumatique
SERTOtool pour les diamètres jusqu'à
10 mm

Pneumatic pre-assembly tool **SERTOtool**
for diameters up to 10 mm

Elektrohydraulisches Vormontagegerät
SERTOspeed für Durchmesser 10 bis
35 mm

Appareil de prémontage electro-hydrau-
lique **SERTOspeed** pour les dimètres de
10 à 35 mm

Electro-hydraulic pre-assembly device
SERTOspeed for diameters 10 to
35 mm

Detaillierte Infos im Kapitel 21.

Pour tous les détails voir chapitre 21.

For all details please see chapter 21.

**Vormontage-
Werkzeuge und
Ergänzungs-
programm**

**Appareils de pré-
montage et
articles complémen-
taires**

**Pre-assembly tools
and
complementary
products**



Seite/Page/Page

Seite/Page/Page

Seite/Page/Page

Elektrohydraulisches Vormontagegerät
Appareil de prémontage électro-hydraulique
Electro-hydraulic pre-assembly device



SERTOspeed

Vormontagegerät pneumatisch
Appareil de prémontage pneumatique
Pneumatic pre-assembly tool



SERTOtool

Winkelspange
Pince d'angle
Bend clip



AC 832

Schlauchsicherungen
Fixations pour tubes
Fixations for tubes



AC SEE

Fixbandroherschelle PP
Collier de fixation PP
Strap mount PP



AC 831

Schlauchklemme PE
Barrette clips PE pour tube
Hose clamp PE

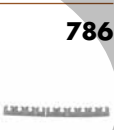

AC SPE

T-Clip POM
T-Clip POM
T-Clip POM



AC 838

Gewindedichtungsband aus PTFE
Ruban d'étanchéité en PTFE
Thread seal tape of PTFE



AC 840

Plasto-Joint
Plasto-Joint
Plasto-Joint

Spezial-Schmieröl
Huile de lubrification spéciale
Special lubrication oil

Schmierstoff OX
Lubrifiant OX
Lubricant OX

Korrosionsschutzbandage aus PE
Ruban adhésif anticorrosion PE
Anti-corrosion adhesive tape PE

Schlauch-Cutty
Coupe-tube Cutty
Hose-Cutty

Schlauch-Schere
Ciseaux coupe-tube
Hose scissors

Einschraub-Schalldämpfer
Silencieux d'échapp. mâle
Silencer male

Kalibrierwerkzeug SERTOflex
Calibreur SERTOflex
Calibration tool SERTOflex

787



AC 833

788



AC 850

788



AC 851 OX

788



AC 860

789



AC 835

789-790



AC 1163

791



AC SDE

792



AC 86600

Entgratungswerkzeug
Outil d'ébavurage
Deburring tool



AC 940

Montagehilfe PA/PVDF
Aide au montage PA/PVDF
Assembly aid PA/PVDF



AC 870

Gabelschlüssel
Clés à fourche
Open ended spanner



AC 880

Montagezange
Pince de montage
Crimping pliers



AC 1098

Montagestutzen
Pièce de montage
Pre-assembly stud



SO 56000

Elektrohydraulisches Vormontagegerät Appareil de prémontage électro-hydraulique Electro-hydraulic pre-assembly device

SERTOspeed

Für die Vormontage von SERTO Verschraubungen von 10 bis 35 mm

Praktisches Tischgerät für SERTO Verschraubungen von 10 mm bis 35 mm. Es eignet sich für Klein- (Projektaufträge) wie auch für Gross-Serien und garantiert dabei eine stets perfekte Vormontage mit konstanter Qualität und hoher Wirtschaftlichkeit.

Pour le prémontage des raccords SERTO de 10 à 35 mm

Unité de table pratique pour les raccords SERTO de 10 mm à 35 mm. Elle convient aussi bien aux petites (commandes de projets) qu'aux grandes séries et garantit un prémontage parfait avec une qualité constante et une grande efficacité.

For the pre-assembly of SERTO unions from 10 to 35 mm

Convenient table-top unit for SERTO unions from 10 mm to 35 mm. It is suitable for small (project orders) as well as large series and guarantees perfect pre-assembly with constant quality and high economic efficiency.

Type	Mat.-Nr.	Spannung/Tension/Voltage
SERTOspeed US-FL/01, 230 Volt	980.3700.000	230 V / 50 Hz / 1 Ph
SERTOspeed US-FL/01, 400 Volt	980.3900.000	400 V / 50 Hz / 3 Ph

Technische Daten

Abmessung: L45 x B63 x H27 cm
Gewicht: 58 kg
Motorleistung: 0.75 kW

Données techniques

Dimension: L45 x l63 x H27 cm
Poids: 58 kg
Puissance moteur: 0.75 kW

Technical data

Dimension: L45 x W63 x H27 cm
Weight: 58 kg
Motor power: 0.75 kW

Vormontageeinheit zu SERTOspeed Unité de prémontage pour SERTOspeed Pre-assembly unit for SERTOspeed

SERTOspeed AD

Vormontageeinheit passend zum SERTOspeed-Gerät für die Vormontage von SERTO Klemmring-Verschraubungen.

Mat.-Nr. 980.3000.000

Variante für Vormontagegerät Tracto Turboform C auf Anfrage.

Unité de prémontage convenant à l'appareil SERTOspeed pour le prémontage des raccords SERTO.

Mat.-No. 980.3000.000

La version pour l'appareil de prémontage Tracto Turboform C disponible sur demande.

Pre-assembly unit suitable for the SERTOspeed device for pre-assembly of SERTO tube unions.

Mat.-No. 980.3000.000

Version for pre-assembly device Tracto Turboform C available on request.

Werkzeugset

Ensemble d'outils

Tool kit

SERTOspeed WZS

Werkzeugeinsatz und Verpressbolzen sind grössenabhängig.

Insert pour outil et goujon de déformation sont dépendants de la taille.

Tool insert and deformation bolt are size dependent.

Für Messing CV Verschraubungen die Ausführung Messing M verwenden.

Pour les raccords en laiton CV, utilisez la version laiton M.

For brass CV unions, use version brass M.

Werkzeugset bestehend aus:

- Werkzeugeinsatz
- Verpressbolzen
- Werkzeughalter

Ensemble d'outils comprenant:

- insert pour outil
- goujon de déformation
- porte-outil

Tool kit consisting of:

- tool insert
- deformation bolt
- tool holder



Werkzeugeinsatz
Insert pour outil
Tool insert



Verpressbolzen
Goujon de déformation
Deformation bolt



Werkzeughalter
Porte-outil
Tool holder

D	Werkzeugset / Ensemble d'outil / Tool kit		
	Messing M Laiton M Brass M	Edelstahl Acier inoxydable Stainless steel	Aluminium
	Mat.-Nr.	Mat.-Nr.	Mat.-Nr.
12	980.3310.120	980.3330.120	980.3360.120
15	980.3310.150	980.3330.150	980.3360.150
18	980.3310.180	980.3330.180	980.3360.180
22	980.3310.220	980.3330.220	980.3360.220
28	980.3310.280	980.3330.280	980.3360.280
35			980.3360.350

Lieferumfang

- Vormontagegerät inkl. Netzkabel (ohne Stecker)

Nach Bedarf separat bestellen:

- Vormontageeinheit SERTOspeed AD
- gewünschtes Werkzeugset SERTOspeed WZS

Dienstleistungen

- Persönliche Vorführung vor Ort
- Ausleihmöglichkeit für Projekte und Aufträge
- Mietdauer 1 bis 3 Monate

Contenu de la livraison

- appareil de prémontage avec câble d'alimentation (sans fiche)

A commander séparément selon les besoins:

- unité de prémontage SERTOspeed AD
- ensemble d'outils désiré SERTOspeed WZS

Services

- démonstration dans vos locaux
- possibilité de prêt pour des projets
- période de location de 1 à 3 mois

Scope of delivery

- pre-assembly device incl. power cable (without plug)

Order separately as required:

- pre-assembly unit SERTOspeed AD
- desired tool kit SERTOspeed WZS

Services

- demonstration at your premises
- possibility of borrowing for projects
- rental period 1 to 3 months

Pneumatisches Vormontagegerät

Appareil à prémontage pneumatique

Pneumatic pre-assembly tool

SERTOtool

Sortiment	Gamme	Product range
SERTOtool für Einsatz mit SERTOtool pour l'usage avec SERTOtool for use with	für Rohrdurchmesser (d) pour diamètres du tube (d) for tube diameters (d)	Mat.-Nr.
Messing M Laiton M Brass M	4, 5, 6, 8, 10	980.2100.000
Messing G Laiton G Brass G	4, 6, 6¼, 8, 10	980 2200.000
Edelstahl Acier inoxydable Stainless steel	4, 5, 6, 8, 10	980 2300.000
Edelstahl L Acier inoxydable L Stainless steel L	6, 8, 10	980 2500.000

SERTOtool ist ein pneumatisches Tischgerät für die sichere und schnelle Montage der SERTO-Verschraubungen.

Mit einem Gewicht von ca. 10 kg ist das Gerät äußerst handlich und kann überall an einen vorhandenen Druckluftanschluss angeschlossen werden. Fünf Werkzeuge für Rohrgrößen von 4 bis 10 mm sind in der drehbaren Werkzeugtrommel enthalten. Sie sind mit den entsprechenden Rohrdurchmessern beschriftet um Verwechslungen vorzubeugen. Der mechanisch begrenzte Hub und die integrierte Zeitverzögerung ergeben eine stets perfekte Verpressung. Nicht geeignet für die Vormontage von Einstellteilen.

SERTOtool ist besonders geeignet für die Vormontage von kleinen bis mittleren Serien und garantiert gleichzeitig konstante Qualität und hohe Wirtschaftlichkeit.

Technische Daten

Abmessung: L33 x B20 x H14 cm
 Gewicht: ca. 10 kg
 Antrieb: Druckluft: 5.5 bis 8 bar
 Spannkraft: ca. 12 kN (bei 6 bar)
 Anschluss: Kupplungsadapter ¼"

SERTOtool est un appareil pneumatique sur table pour le montage rapide et en toute sécurité des raccords SERTO.

Avec un poids d'environ 10 kg, l'appareil est particulièrement pratique et utilisable partout où un raccordement en air comprimé est possible. Le tambour à outillage rotatif comprend cinq outils pour traiter des diamètres allant de 4 à 10 mm. Les diamètres correspondants sont indiqués sur chaque outil pour éviter toute confusion. La course mécaniquement limitée du cylindre et le délai intégré dans la machine garantissent d'excellents résultats de sertissage. Ne convient pas cependant pour des pièces à réglage.

SERTOtool convient parfaitement au pré-montage de séries petites à moyennes et garantit une qualité constante et un rendement élevé.

Données techniques

Dimension: L33 x l20 x h14 cm
 Poids: env. 10 kg
 Commande: pneumatique, 5,5 à 8 bar
 Force de serrage: env. 12 kN (à 6 bar)
 Connexion: Coupleur ¼"

SERTOtool is a pneumatic tabletop unit for safe and fast assembly of SERTO unions.

Weighing only approx. 10 kg, the unit is extremely handy and can be connected to any compressed air supply. Five tools for tube sizes from 4 to 10 mm are contained in the rotatable tool drum. They are labelled with the corresponding tube diameters to prevent mix-ups. The mechanically limited stroke and the integrated time delay ensure perfect pressing every time. Not suitable for the pre-assembly of adjustable parts.

SERTOtool is especially suitable for pre-assembly small to medium series and guarantees constant quality and high efficiency.

Technical data

Dimensions: L33 x W20 x H14 cm
 Weight: approx. 10 kg
 Power: compressed air: 5.5 to 8 bar
 Clamping force: approx. 12 kN (at 6 bar)
 Connection: Coupling ¼"

Winkelspange PA 90°
Pince d'angle PA 90°
Bend clip PA 90°

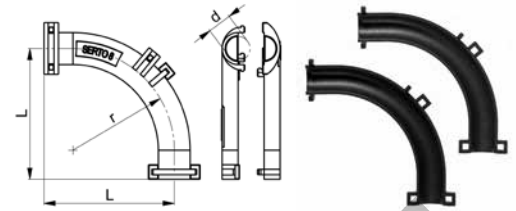
AC 832 90°

Type-d	Mat.-Nr.	L	r	g/Stk
AC 832-6 90°	988.8325.060	40.0	30	4
AC 832-6 90° BU	988.8325.060.BU	40.0	30	4
AC 832-8 90°	988.8325.080	45.5	35	5
AC 832-8 90° BU	988.8325.080.BU	45.5	35	5
AC 832-10 90°	988.8325.100	54.0	40	14
AC 832-10 90° BU	988.8325.100.BU	54.0	40	14
AC 832-12 90°	988.8325.120	65.0	50	19
AC 832-12 90° BU	988.8325.120.BU	65.0	50	19

Winkelspange PA 90° montiert
Pince d'angle PA 90° assemblé
Bend clip PA 90° assembled

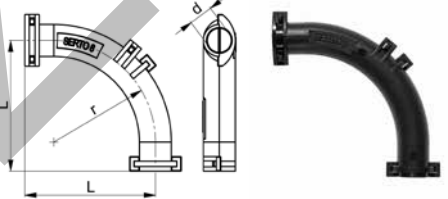
AC 832 90° M

Type-d	Mat.-Nr.	L	r	g/Stk
AC 832-6 90° M	988.8370.060	40.0	30	4
AC 832-6 90° M BU	988.8370.060.BU	40.0	30	4
AC 832-8 90° M	988.8370.080	45.5	35	5
AC 832-8 90° M BU	988.8370.080.BU	45.5	35	5
AC 832-10 90° M	988.8370.100	54.0	40	14
AC 832-10 90° M BU	988.8370.100.BU	54.0	40	14
AC 832-12 90° M	988.8370.120	65.0	50	19
AC 832-12 90° M BU	988.8370.120.BU	65.0	50	19

Führung und Schutz für eng abgebogene Kunststoffrohre, verhindert ein Knicken des Rohres.

Geeignet für PA, PU, LDPE, PTFE, FEP-Rohre; nicht geeignet für PVDF-Rohre.

Material

PA66 GF25, Brandverhalten gem. UL 94 V0

Einsatztemperatur

-40°C bis +130°C

Liefereinheit (VPE)

Pack à 10 Set Winkelspangen montiert

BU = Pack à 250 Set Winkelspangen montiert

Guidage et protection pour tubes plastiques fortement coudés, évite le pliage du tuyau.

Convient aux tubes en PA, PU, LDPE, PTFE, FEP; ne convient pas aux tubes en PVDF.

Matériau

PA66 GF25, inflammabilité selon UL 94 V0

Température d'application

-40°C à +130°C

Unité de livraison (UE)

Sac à 10 sets pinces d'angle assemblés

BU = sac à 250 sets pinces d'angle assemblés

Location and protection for tightly curved plastic tubes, prevents kinking of the tube.

Suitable for PA, PU, LDPE, PTFE, FEP tubes; not suitable for PVDF tubes.

Material

PA66 GF25, flammability acc. to UL 94 V0

Operation temperature

-40°C to +130°C

Packaging unit (VPE)

Pack of 10 sets bend clips assembled

BU = pack of 250 sets bend clips assembled

Winkelspange PA 45°
Pince d'angle PA 45°
Bend clip PA 45°

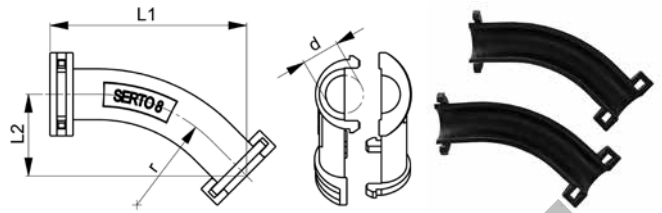

AC 832 45°

Type -d	Mat.-Nr.	L1	L2	r	g/Stk
AC 832-8 45°	988.8345.080	42.7	17.7	35	3
AC 832-8 45° BU	988.8345.080.BU	42.7	17.7	35	3
AC 832-12 45°	988.8345.120	58.0	24.0	50	12
AC 832-12 45° BU	988.8345.120.BU	58.0	24.0	50	12

Winkelspange PA 45° montiert
Pince d'angle PA 45° assemblé
Bend clip PA 45° assembled

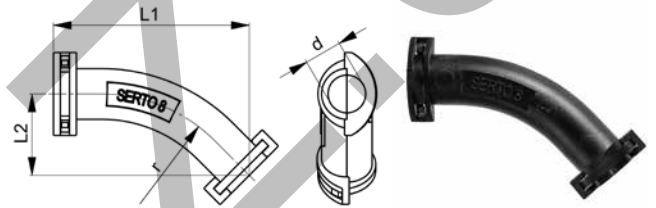

AC 832 45° M

Type -d	Mat.-Nr.	L1	L2	r	g/Stk
AC 832-8 45° M	988.8375.080	42.7	17.7	35	3
AC 832-8 45° M BU	988.8375.080.BU	42.7	17.7	35	3
AC 832-12 45° M	988.8375.120	58.0	24.0	50	12
AC 832-12 45° M BU	988.8375.120.BU	58.0	24.0	50	12

Führung und Schutz für eng abgebogene Kunststoffrohre, verhindert ein Knicken des Rohres.

Geeignet für PA, PU, LDPE, PTFE, FEP-Rohre; nicht geeignet für PVDF-Rohre.

Material

PA66 GF25, Brandverhalten gem. UL 94 V0

Einsatztemperatur

-40°C bis +130°C

Liefereinheit (VPE)

Pack à 10 Set Winkelspangen montiert

BU = Pack à 250 Set Winkelspangen montiert

Guidage et protection pour tubes plastiques fortement coudés, évite le pliage du tuyau.

Convient aux tubes en PA, PU, LDPE, PTFE, FEP; ne convient pas aux tubes en PVDF.

Matériau

PA66 GF25, inflammabilité selon UL 94 V0

Température d'application

-40°C à +130°C

Unité de livraison (UE)

Sac à 10 sets pinces d'angle assemblés

BU = sac à 250 sets pinces d'angle assemblés

Location and protection for tightly curved plastic tubes, prevents kinking of the tube.

Suitable for PA, PU, LDPE, PTFE, FEP tubes; not suitable for PVDF tubes.

Material

PA66 GF25, flammability acc. to UL 94 V0

Operation temperature

-40°C to +130°C

Packaging unit (VPE)

Pack of 10 sets bend clips assembled

BU = pack of 250 sets bend clips assembled

Einohrschelle

Edelstahl (1.4307) mit montiertem Einlagering

Collier à oreille

acier inoxydable (1.4307) à bague prémontée

One-ear clamp

stainless steel (1.4307) with insertion ring

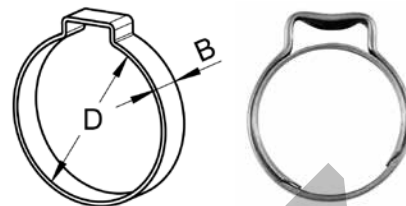

AC SEE

Type -d -D	Mat.-Nr.	B	g/Stk
AC SEE-2,5-2,9 (3.3)	YBD.SEE.0001	5.5	1
AC SEE-2,7-3,1 (3.5)	YBD.SEE.0002	5.5	1
AC SEE-2,9-3,7 (4.1)	YBD.SEE.0003	5.5	1
AC SEE-3,7-4,7 (5.1)	YBD.SEE.0004	5.5	1
AC SEE-4,7-5,7 (6.1)	YBD.SEE.0005	5.5	1
AC SEE-5,2-6,2 (6.6)	YBD.SEE.0006	5.5	1
AC SEE-5,9-7,0 (7.5)	YBD.SEE.0007	6.4	1
AC SEE-7,0-8,5 (9.0)	YBD.SEE.0008	7.4	1
AC SEE-7,5-9,0 (9.5)	YBD.SEE.0009	7.4	2
AC SEE-8,8-10,5 (11.0)	YBD.SEE.0010	7.4	2
AC SEE-9,1-10,8 (11.3)	YBD.SEE.0011	7.4	2
AC SEE-10,3-12,3 (12.8)	YBD.SEE.0012	7.4	2
AC SEE-11,3-13,3 (14.0)	YBD.SEE.0013	8.2	3
AC SEE-12,3-14,3 (15.0)	YBD.SEE.0014	8.2	3
AC SEE-13,2-15,8 (16.5)	YBD.SEE.0015	8.2	3
AC SEE-14,6-16,8 (17.5)	YBD.SEE.0016	8.2	4
AC SEE-16,5-18,8 (19.5)	YBD.SEE.0017	8.2	4
AC SEE-18,0-20,3 (21.0)	YBD.SEE.0018	9.2	5
AC SEE-20,2-22,8 (23.5)	YBD.SEE.0019	9.2	6
AC SEE-23,0-25,6 (26.3)	YBD.SEE.0020	9.2	7

Schlauchklemme

Stahl promatverzinkt

Collier de serrage

acier zingué passivé

Hose clip

zinc promatised steel

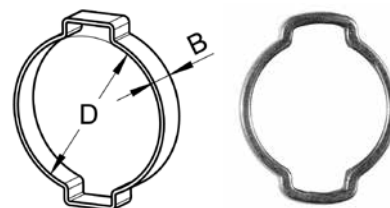

SO 40512

Type -d	Mat.-Nr.	B	D	g/Stk
SO 40512-3-5	016.0610.030	5.0	5.0	1
SO 40512-5-7	016.0610.050	3.0	7.0	1
SO 40512-7-9	016.0610.070	7.0	9.0	2
SO 40512-9-11	016.0610.090	7.0	11.0	3
SO 40512-11-13	016.0610.110	7.0	13.0	3
SO 40512-13-15	016.0610.130	7.5	15.0	3
SO 40512-15-18	016.0610.150	8.0	18.0	5
SO 40512-17-20	016.0610.170	8.5	20.0	6
SO 40512-20-23	016.0610.200	9.0	23.0	9
SO 40512-23-27	016.0610.230	10.0	27.0	12

Schneckengewindeschelle

Edelstahl (1.4301)

Collier à vis sans fin

acier inoxydable (1.4301)

Worm-drive hose clamp

stainless steel (1.4301)

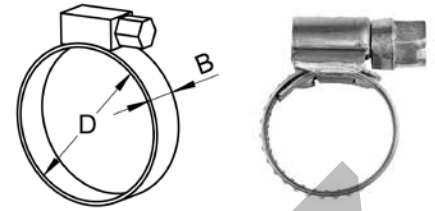

AC SGE

Type -d-D	Mat.-Nr.	B	g/Stk
AC SGE-8-12	YBD.SGE.0001	9.0	10
AC SGE-10-16	YBD.SGE.0002	9.0	11
AC SGE-12-20	YBD.SGE.0003	9.0	11
AC SGE-16-27	YBD.SGE.0004	9.0	14
AC SGE-20-32	YBD.SGE.0005	9.0	15
AC SGE-23-35	YBD.SGE.0006	9.0	15
AC SGE-25-40	YBD.SGE.0007	9.0	16
AC SGE-32-50	YBD.SGE.0008	9.0	18
AC SGE-40-60	YBD.SGE.0009	9.0	19

Fixbandrohrschele PP

Collier de fixation PP

Strap mount PP

AC 831

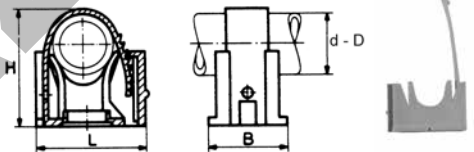

Type	Mat.-Nr.	d	D	L	B	H	g/Stk
AC 831-0	988.8310.000	6.00	9.0	18.0	19.0	23.0	2
AC 831-1	988.8310.010	9.00	13.0	23.0	19.0	28.0	2
AC 831-2	988.8310.020	14.00	18.0	27.0	19.0	32.0	3
AC 831-3	988.8310.030	18.00	22.0	32.0	19.0	36.0	4

Bewährtes Befestigungselement für Kabel und Rohre aus grauem, verschleißfestem Kunststoff.

Das angespritzte, starke Kunststoffband wird um das Rohr gelegt und mit seiner Zahnung in die Schelle gestossen; eine einfache und sichere Rohrhalterung. Fixbandrohrschele können aufgeschraubt (Befestigungsloch 5,5 mm) oder angeklebt werden und sind als Einzelschele oder zu Reihen zusammengefügt (Schwalbenschwanz) vielseitig einsetzbar.

Werkstoff: Polypropylen
Temperaturbereich: -20°C bis +60°C
Farbe: grau RAL 7032

Élément de fixation éprouvé pour câbles et tuyaux, en matière plastique grise inusable.

La bande en plastique solide est enroulée autour du tube et introduite avec sa denture dans l'agrafe: une fixation simple et sûre. Les agrafes pour colliers de fixation peuvent être vissées (trou de fixation 5,5 mm) ou collées et sont d'une utilisation universelle, soit isolément, soit montées en série (queue d'aronde).

Matériau: Polypropylène
Plage de température: -20°C à +60°C
Couleur: gris RAL 7032

An efficient fixture element for cables and tubes, of grey, wear resistant plastic.

The strong integral plastic strap is laid round the tube and pressed into the holder, the strap teeth providing an easy, safe hold. Strap mounts can be screwed (clearance hole 5,5 mm) or stuck in position, and can be used singly or assembled in batteries (dove tailing) for many purposes.

Material: Polypropylene
Temperature range: -20°C to +60°C
Color: grey RAL 7032

Schlauchklemme PE

Barrette clips PE pour tube

Hose clamp PE

AC SPE

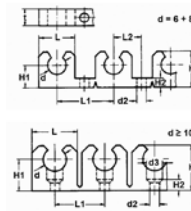

Type-d	Mat.-Nr.	L	L1	L2	H	H1	H2	d2	d3	g/Stk
AC SPE-6	YBD.SPE.0001	12.0	21.0	10.0	14.0	10.0	4.0	4.00	0.00	21
AC SPE-8	YBD.SPE.0002	16.0	25.0	12.0	16.0	10.0	4.0	4.00	0.00	28
AC SPE-10	YBD.SPE.0003	20.0	22.0	0.0	20.0	14.0	5.0	4.00	7.00	39
AC SPE-12	YBD.SPE.0004	24.0	26.0	0.0	21.0	14.0	5.0	4.00	7.00	47
AC SPE-15	YBD.SPE.0005	27.0	29.0	0.0	34.0	26.0	5.0	4.30	8.50	31
AC SPE-18	YBD.SPE.0006	31.0	33.0	0.0	35.5	26.0	5.0	4.30	8.50	37
AC SPE-22	YBD.SPE.0007	36.0	38.0	0.0	37.0	26.0	5.0	4.30	8.50	52
AC SPE-28	YBD.SPE.0008	44.0	46.0	0.0	39.0	26.0	5.0	4.30	8.50	63

Die Klemmen für Rohrdurchmesser 6 bis 12 mm sind jeweils in Leisten zu **10 Stück**, die Klemmen für Rohrdurchmesser 15 bis 28 mm in Leisten zu **5 Stück** gefertigt.

Werkstoff: Polyethylen (PE)
Temperaturbereich: -20°C bis +50°C

Les barrettes pour diamètre du tube de 6 à 12 mm sont fabriqués par séries de **10 clips**, les colliers pour diamètre du tube de 15 à 28 mm par séries de **5 clips**.

Matériau: polyéthylène (PE)
Plage de température: -20°C à +50°C

The clamps for tube diameters 6 to 12 mm are available in **strips of 10 pieces** each, the clamps for tube diameters 15 to 28 mm in **strips of 5 pieces** each.

Material: polyethylene (PE)
Temperature range: -20°C to +50°C

T-Clip POM

T-Clip POM

T-Clip POM

AC 838

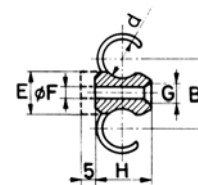
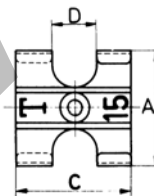

Type-d	Mat.-Nr.	A	B	C	D	E	F	H	g/Stk
AC 838-4	988.8380.040	15.0	10.0	17.0	6.0	6.0	3.0	7.0	1
AC 838-6	988.8380.060	20.0	12.0	20.0	8.0	8.0	3.0	9.0	1
AC 838-8	988.8380.080	25.0	17.0	24.0	10.0	10.0	4.0	12.0	2
AC 838-10	988.8380.100	30.0	18.0	28.0	12.0	11.0	4.0	15.0	4
AC 838-12	988.8380.120	34.0	21.0	34.0	14.0	12.0	4.0	17.0	6
AC 838-15	988.8380.150	42.0	25.0	41.0	17.0	14.0	5.0	20.0	9
AC 838-18	988.8380.180	50.0	30.0	47.0	20.0	16.0	6.0	23.0	14
AC 838-22	988.8380.220	63.0	37.0	61.0	23.0	20.0	6.0	28.0	29

Für Rohre aus Kunststoff, Kupfer, Stahl, Edelstahl etc., Schläuche und Kabel.
8 Größen von Ø 4-22 mm.
Zwischenabmessungen wie Ø 9,52 mm werden mit dem kleineren T-Clip verbunden (Ø 9,52 mm mit AC 838-8).

Werkstoff: POM
Temperaturbereich: -40°C bis +100°C

Pour tubes en plastiques, cuivre, acier, acier inoxydable et d'autres tuyaux, souples et câbles.
8 dimensions de Ø 4-22 mm.
Les diamètres intermédiaires par ex. Ø 9,52 mm sont à connecter par des T-Clip plus petits (Ø 9,52 mm avec AC 838-8).

Matériau: POM
Plage de température: -40°C à +100°C

For tubings of plastic, copper, steel, stainless steel and other plastic hoses and cables.
8 sizes from Ø 4-22 mm.
Non-standard dimensions such as Ø 9,52 mm or others can be connected with the smaller T-Clip (Ø 9,52 mm with AC 838-8).

Material: POM
Temperature range: -40°C to +100°C

Gewindedichtungsband aus PTFE

Ruban d'étanchéité en PTFE

Thread seal tape of PTFE

AC 840

Type	Mat.-Nr.	g/Stk
AC 840-6 (1/4")	988.8400.060	15
AC 840-9 (3/8")	988.8400.090	17

Gute chemische Beständigkeit für breite Einsatzmöglichkeiten.

Nicht-härtendes Dichtungsband für sauberes und schnelles Umwickeln der kegeligen Einschraubgewinde. Nicht alternd und immer gebrauchsfertig, das beliebte Mittel für eine dauerhafte Abdichtung.

Lieferart: in Rollen à 12 m

Bonne résistance chimique dans la plupart des utilisations.

Ruban d'étanchéité souple pour filetages mâles coniques. Pas de vieillissement et toujours prêt à l'emploi, moyen apprécié pour réaliser des étanchéités durables.

Mode de livraison: en rouleaux à 12 m

Good chemical resistance for a wide range of applications.

Flexible seal tape for rapid and clean winding on the tapered adaptor thread. No aging and always ready for use, the popular material for a durable sealing.

Form of supply: in rolls of 12 m

Plasto-Joint

Plasto-Joint

Plasto-Joint

AC 833

Type	Mat.-Nr.	g/Stk
AC 833	988.8330.000	45

Temperatur max. +60°C

Stift zum Abdichten der kegeligen Einschraubgewinde bei Kunststoffteilen. Da nach dem Auftragen der schmierfähigen Dichtmasse keine Verhärtung erfolgt, ist die Dichtstelle unempfindlich gegen Vibrationen, Temperaturwechsel usw. und jederzeit leicht lösbar.

Nur für den gewerblichen Verwender.

Température max. +60°C

Bâton pour assurer l'étanchéité des filetages mâles coniques des raccords en plastique. Comme la pâte ne durcit pas, la zone d'étanchéité est insensible aux vibrations, variations de température, etc. Le raccord peut être dévissé à tout moment sans difficulté.

Seulement pour des utilisateurs professionnels.

Temperature max. +60°C

Stick for sealing the tapered screw-in thread of plastic unions. As the kneadable sealant does not harden, the sealing point is insensitive to vibration, temperature change etc., and can be detached any time.

For professional users only.



Spezial-Schmieröl

Huile de lubrification spéciale

Special lubrication oil

AC 850

Type	Mat.-Nr.	g/Stk
AC 850	TAC.850.0000	244

Für die Montage von Verschraubungen, besonders aus Edelstahl.

Surtout pour le montage des raccords en acier inoxydable.

Especially for installing tube unions made of stainless steel.

Lieferart: in Flaschen à 250 ml

Livré en flacons à 250 ml

Form of supply: in bottles of 250 ml

Nur für den gewerblichen Verwender.

Seulement pour des utilisateurs professionnels.

For professional users only.



Schmierstoff OX

Lubrifiant OX

Lubricant OX

AC 851 OX

Type	Mat.-Nr.	g/Stk
AC 851 OX	TAC.850.0001	111

Schmierstoff für den Einsatz mit Sauerstoff (getestet von der BAM).

Lubrifiant pour utilisation sous oxygène (testé par BAM).

Lubricant for use in oxygene enriched systems (tested by BAM).

Lieferart: in Tuben à 100 g

Mode de livraison: par tubes de 100 g

Form of supply: in tubes of 100 g

Nur für den gewerblichen Verwender.

Seulement pour des utilisateurs professionnels.

For professional users only.

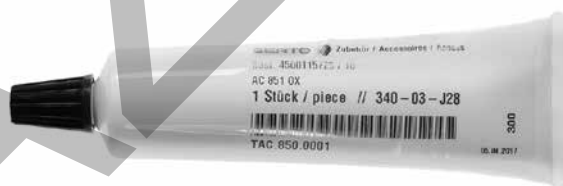

Korrosionsschutzbandage aus PE

Ruban adhésif anticorrosion PE

Anti-corrosion adhesive tape PE

AC 860

Type	Mat.-Nr.	g/Stk
AC 860	988.8410.019	41

Breite: 19 mm
Dicke: 0.15 mm
Länge: 10 m

Largeur: 19 mm
Épaisseur: 0.15 mm
Longueur: 10 m

Width: 19 mm
Thickness: 0.15 mm
Length: 10 m



Schlauch-Cutty
Coupe-tube Cutty
Hose-Cutty



AC 835

Type	Mat.-Nr.	g/Stk
AC 835	988.8350.000	23

Praktisches, handliches Werkzeug zum sauberen Ablängen der Kunststoffrohre und -schläuche bis 12 mm Aussen-Ø.

Outil pratique et maniable pour couper proprement les longueurs des tubes et tuyaux en plastique jusqu'à un Ø extérieur de 12 mm.

Useful, handy tool for clean cut off of plastic tubes and hoses of up to 12 mm outer diameter.

Ersatzmesser
für Schlauch-Cutty AC 835

Couteau de rechange
pour coupe-tube Cutty AC 835

Spare blade
for hose-cutty AC 835



AC 836

Type	Mat.-Nr.	g/Stk
AC 836	988.8360.000	80

Lieferart: Pack à 10 Stk.

Mode de livraison: box à 10 pcs.

Form of supply: box with 10 pcs

Schlauch-Schere
für Kunststoffrohre und -schläuche bis Ø 22 mm

Ciseaux coupe-tube
pour tubes et tuyaux en plastique jusqu'à Ø 22 mm

Hose scissors
for tubes and hoses in plastic up to Ø 22 mm



AC 1163

Type	Mat.-Nr.	g/Stk
AC 1163	YBD.1163.001	280

Ersatzmesser

für Schlauch-Schere AC 1163

Couteau de rechange

pour ciseaux coupe-tube AC 1163

Spare blade

for hose scissors AC 1163

AC 1164

Type	Mat.-Nr.	g/Stk
AC 1164	YBD.1164.001	6

KROVANZ.COM

Einschraub-Schalldämpfer

aus Bronze

Silencieux d'échappement mâle

en bronze

Silencer male

in bronze

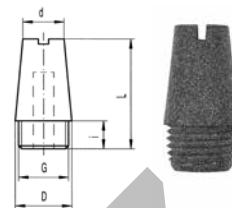

AC SDS

Type -G	Mat.-Nr.	d	L	D	i	g/Stk
AC SDS-1/8	YBD.SDS.0001	8.00	21.0	10.5	5.5	7
AC SDS-1/4	YBD.SDS.0002	10.00	27.2	14.0	8.0	14
AC SDS-3/8	YBD.SDS.0003	15.00	36.0	18.0	10.0	29
AC SDS-1/2	YBD.SDS.0004	19.00	44.0	23.5	11.0	65
AC SDS-3/4	YBD.SDS.0005	20.00	65.0	29.0	12.0	113

Einschraub-Schalldämpfer

aus Polyethylen

Silencieux d'échappement mâle

en polyéthylène

Silencer male

in polyethylene

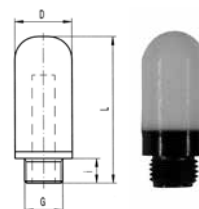

AC SDK

Type -G	Mat.-Nr.	L	D	i	g/Stk
AC SDK-1/8	YBD.SDK.0001	34.0	13.0	6.5	2
AC SDK-1/4	YBD.SDK.0002	41.5	16.5	6.5	3
AC SDK-3/8	YBD.SDK.0003	67.0	24.0	10.0	13
AC SDK-1/2	YBD.SDK.0004	71.5	25.5	11.5	10

Einschraub-Schalldämpfer

aus Edelstahl

Silencieux d'échappement mâle

en acier inoxydable

Silencer male

in stainless steel

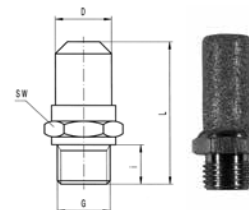

AC SDE

Type -G	Mat.-Nr.	SW	L	D	i	g/Stk
AC SDE-1/8	YBD.SDE.0001	13	27.0	10.0	6.5	9
AC SDE-1/4	YBD.SDE.0002	16	40.0	12.5	9.0	17

Kalibrierwerkzeug SERTOflex

Calibreur SERTOflex

Calibration tool SERTOflex

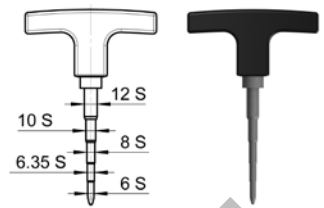
AC 86600

Type	Mat.-Nr.	g/Stk
AC 86600	988.8660.000	143

Für Nennweiten 6/6,35/8/10/12 mm

Pour diamètres nom. 6/6,35/8/10/12 mm

For nominal widths 6/6,35/8/10/12 mm

Empfohlen zur Kalibrierung der Rohrenden von SERTOflex, da durch das Ablängen Verformungen entstehen können. Damit wird bei fachgerechter Montage die Dichtheit gewährleistet.

Recommandation sur le calibrage des extrémités de tuyaux de SERTOflex, la découpe pouvant entraîner des déformations. Permet de garantir l'étanchéité si le montage est effectué correctement.

Recommended for calibration of the SERTOflex pipe ends, as deformations may be caused by cutting them to length. This ensures that there are no leaks if fitting is carried out properly.

Werkstoff: Inox 1.4305

Matériau: Inox 1.4305

Material: Inox 1.4305

Entgratungswerkzeug

Outil d'ébavurage

Deburring tool

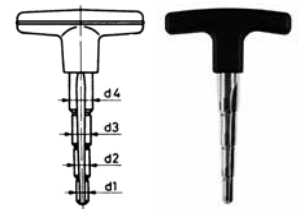
AC 940

Type	Mat.-Nr.	d1	d2	d3	d4	g/Stk
AC 940-4-6-8	988.8403.600	4.00	6.00	8.00	0.00	87
AC 940-8-10-12-15	988.8403.700	8.00	10.00	12.00	15.00	133
AC 940-8-10-13-16	988.8403.800	8.00	10.00	13.00	16.00	138
AC 940-4.4-6.4-8.4	988.8426.700	4.40	6.40	8.40	0.00	89
AC 940-8.4-10-13-16	988.8426.800	8.40	10.00	13.00	16.00	139

Dieses abgestufte Entgratungswerkzeug wurde zum Entgraten von Edelstahl-, Kupfer- und Aluminiumrohren entwickelt. Der Grat kann mit einem Werkzeug an drei bzw. vier verschiedenen Rohrdurchmessern gebrochen werden. Das Werkzeug ist auf unsere Stützhülsen abgestimmt.

Cet outil d'ébavurage étagé a été développé pour l'ébavurage de tubes en acier inoxydable, cuivre et aluminium. La bavure peut être cassée avec un outil sur trois ou quatre différents diamètres de tube. L'outil est adapté à nos douilles d'appui.

This multi-diameter deburring tool has been developed for deburring stainless steel, copper and aluminium tubes. The burrs can be removed with one tool on three or four different tube diameters. The tool is designed to match our stiffener sleeves.

Werkstoff: Stahl 1.2516

Matériau: Acier 1.2516

Material: Steel 1.2516

Montagehilfe

für Klemmringe PVDF/PA

Aide au montage

pour bagues de serrage PVDF/PA

Assembly aid

for compression ferrules PVDF/PA

AC 870



Type	Mat.-Nr.	d	M	SW	L1	L2	D	g/Stk
AC 870-0	988.8700.000	0.00	6	20	120.0	10.0	22.0	95
AC 870-6	988.8700.060	6.00	6	15	25.0	8.0	8.8	16
AC 870-8	988.8700.080	8.00	6	15	25.0	8.0	10.9	17
AC 870-10	988.8700.100	10.00	6	15	25.0	8.0	12.7	18
AC 870-12	988.8700.120	12.00	6	15	25.0	8.0	14.8	17
AC 870-16	988.8700.160	16.00	6	15	31.0	8.0	20.2	31

Anwendungsbeispiele:

Exemples d'utilisation:

Sample combinations:

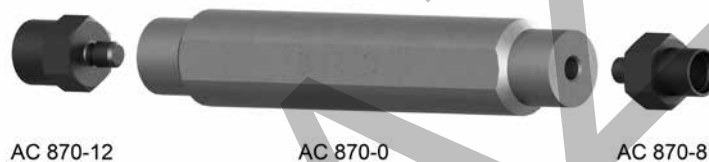

Einsatz:

Unterstützt die Montage der Klemmringe auf Einstellteilen (Schaft).

Anwendung:

Am Griff AC 870-0 können verschiedene Größen von Einsätzen links und rechts befestigt werden.

Material:

Griff (AC 870-0): Aluminium
Einsätze (AC 870-6 bis -16): Edelstahl 1.4571

Bitte jedes Teil separat bestellen.

Application:

Supporte le montage des bagues de serrage sur les manches.

Utilisation:

Différentes tailles d'inserts peuvent être fixées des deux côtés de la poignée AC 870-0.

Matériau:

Poignée (AC 870-0): aluminium
Inserts (AC 870-6 à -16): acier inoxydable 1.4571

Veuillez commander chaque pièce séparément.

Application:

Supports the assembly of compression ferrules on shaft components.

Operation:

Different sizes of inserts can be fixed on both sides of the handle AC 870-0.

Material:

Handle (AC 870-0): aluminium
Inserts (AC 870-6 to -16): stainless steel 1.4571

Please order each part separately.

Gabelschlüssel

für Verschraubungen PVDF/PA

Clés à fourche

pour raccords PVDF/PA

Open ended spanner

for unions PVDF/PA



AC 880

Type -d	Mat.-Nr.	g/Stk
AC 880 SET	988.8800.000	52
AC 880-6	988.8800.060	7
AC 880-8	988.8800.080	9
AC 880-10	988.8800.100	13
AC 880-12	988.8800.120	16

Montagehilfe bei engen Platzverhältnissen für Kunststoff-Verschraubungen in den Größen 6, 8, 10, 12 mm.

Erhältlich als Set mit allen Größen oder als einzelne Größen.

Werkstoff: Edelstahl 1.4301

Aide au montage pour espaces restreints pour les raccords en plastique des dimensions 6, 8, 10, 12 mm.

Disponible comme set avec tous les dimensions ou en dimensions individuelles.

Matériau: Acier inoxydable 1.4301

Assembly aid for tight spaces for plastic unions in sizes 6, 8, 10, 12 mm.

Available as a set with all sizes or individual sizes.

Material: Stainless steel 1.4301

Montagezange

für Einohrschellen und Schlauchklemmen

Pince de montage

pour collier de serrage

Crimping pliers

for one-ear clamps or hose clips



AC 1098

Type	Mat.-Nr.	g/Stk
AC 1098	YBD.1098.001	315

Montagestutzen

für Messing G Verschraubungen

Outil de prémontage

pour raccords en laiton G

Pre-assembly stud

for brass G unions

SO 06000

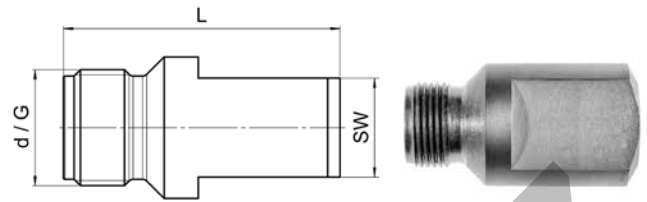

Type -d	Mat.-Nr.	G	SW	L	g/Stk
SO 06000-4/5/6	248.6000.020	1/8	11	38.0	38
SO 06000-8	248.6000.040	1/4	14	40.0	68
SO 06000-10	248.6000.060	3/8	14	39.0	75
SO 06000-12/14/15	248.6000.080	1/2	17	41.0	106

Montagestutzen

für Edelstahl, Messing M, Aluminium Verschraubungen

Outil de prémontage

pour raccords en acier inox, laiton M, aluminium

Pre-assembly stud

for stainless steel, brass M, aluminium unions

SO 56000

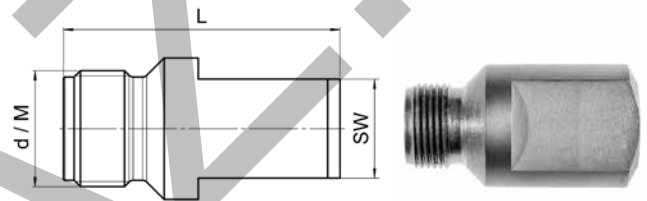

Type -d	Mat.-Nr.	M	SW	L	g/Stk
SO 56000-6/6,35	058.6000.060	10x1.0	11	36.0	37
SO 56000-8	058.6000.080	12x1.0	11	37.0	41
SO 56000-10/9,52	058.6000.100	14x1.0	14	37.0	65
SO 56000-12	058.6000.120	16x1.0	14	37.0	70
SO 56000-15/12,7/13,5-14	058.6000.150	20x1.5	17	40.0	101
SO 56000-18/16/17,2	058.6000.180	24x1.5	19	40.0	142
SO 56000-22/21,3	058.6000.220	28x1.5	22	40.0	189
SO 56000-28	058.6000.280	36x2.0	27	46.0	347
SO 56000-35	058.6000.350	42x2.0	36	60.0	642

Fortsetzung nächste Seite

Suite à la prochaine page

Continued on next page

Montagestützen

für Stahl Verschraubungen

Outil de prémontage

pour raccords en acier

Pre-assembly stud

for steel unions

SO 6000

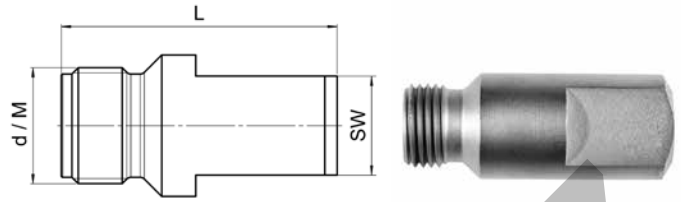

Type -d	Mat.-Nr.	M	L	SW	g/Stk
SO 6000-6	218.6000.060	12x1.5	40.0	11	44
SO 6000-8	218.6000.080	14x1.5	40.0	14	70
SO 6000-10	218.6000.100	16x1.5	40.0	14	97
SO 6000-12	218.6000.120	18x1.5	40.0	17	124
SO 6000-14	218.6000.140	22x1.5	40.0	19	200
SO 6000-15	218.6000.150	22x1.5	40.0	19	201
SO 6000-16	218.6000.160	24x1.5	40.0	19	214
SO 6000-18	218.6000.180	26x1.5	40.0	22	284
SO 6000-20	218.6000.200	26x1.5	40.0	22	284
SO 6000-22	218.6000.220	30x2.0	58.0	24	363
SO 6000-25	218.6000.250	33x2.0	58.0	24	390
SO 6000-28	218.6000.280	36x2.0	58.0	27	530
SO 6000-30	218.6000.300	39x2.0	58.0	30	580

Anwendungsbeispiele:

Der Montagestützen wird zur Vormontage des Armaturenanschlusses verwendet.

Anleitung:

Montagestützen in Schraubstock einspannen.
 Armaturenanschluss aufschrauben.
 Rohr in Armaturenanschluss stecken.
 Anschlussmutter mit Gabelschlüssel ca. 1 1/2 Umdrehungen anziehen (mechanischer Anschlag).
 Endmontage im Gerät ca. 1/4 Umdrehung.

Auf saubere Planfläche achten.

Zur Erleichterung der Montage sollte das Gewinde und die Planfläche ab und zu geölt werden.

Bitte Montageanleitung beachten.

Für automatisierte Vormontage siehe Apparate SERTOtool/SERTOspeed im Kapitel 21.

Material: Stahl 1.2312

Exemples d'utilisation:

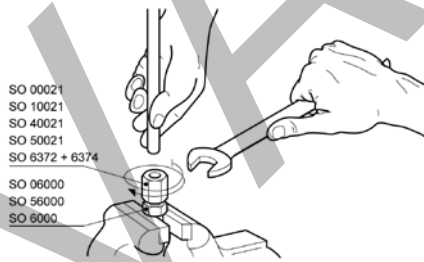

L'outil de prémontage s'utilise pour le prémontage standard de l'écrou de raccord.

Instruction:

Serrer l'outil de prémontage dans l'étai.
 Visser l'écrou de raccord.
 Enfiler le tube dans l'écrou de raccord.
 Au moyen d'une clé à fourche serrer l'écrou d'env. 1 1/2 tours (butée mécanique).
 Montage final dans l'appareil d'env. 1/4 de tour.

La surface d'étanchéité doit être propre.

La lubrification occasionnelle du filetage et de la surface d'étanchéité facilite le montage.

Consultez les instructions de montage.

Pour prémontage automatique voir les appareils SERTOtool/SERTOspeed au chapitre 21.

Matériau: acier 1.2312

Sample combinations:

The pre-assembly stud is used for the pre-fitting of the nut connection.

Instructions:

Clamp the pre-assembly stud in a vise.
 Screw on the nut connection.
 Push the tube into the nut connection.
 Tighten the union nut approx. 1 1/2 turns with an open ended spanner (mechanical stop).
 Final assembly in the equipment approx. 1/4 turn.

Keep the flat metal surface clean.

Occasional lubrication of the thread and the flat metal surface facilitate pre-assembly.

Please refer to the installation instructions.

For automated pre-assembly see the devices SERTOtool/SERTOspeed in chapter 21.

Material: Steel 1.2312

Dienstleistungen

Reinigungen
Gewindeabdichtungen
Oberflächenveredelung
Sonderkonstruktionen

Services

Nettoyages spéciaux
Filetages pré-enduits
Traitements de surface
Constructions spéciales

Services

Cleaning
Thread seals
Surface finishing
Special designs



Dienstleistungen	Service	Service	
Übersicht	Aperçu	Overview	
800	Spezialreinigung - enfettet, ungeschmiert	Nettoyage spécial - dégraissé, non lubrifié	Special cleaning - degreased, unlubricated
801	Spezialbehandlung - für Einsatz mit Sauerstoff	Traitement spécial - pour utilisation sous oxygène	Special treatment - for use with oxygen
802	Spezialbehandlung - silikonfrei	Traitement spécial - sans silicone	Special treatment - silicone-free
803	Vorbeschichtete Einschraubgewinde mit PTFE-Band umwickelt	Filetages pré-enduits avec ruban en PTFE	Pre-coated threads with PTFE-tape
804	Vorbeschichtete Einschraubgewinde mit Loctite 5061	Filetages pré-enduits avec Loctite 5061	Pre-coated threads with Loctite 5061
805	Chemisch vernickelt	Nickelage chimique	Chemically nickel-plated
806	Messing bleiarml	Laiton à faible teneur en plomb	Low-lead brass
807	Engineering	Ingénierie	Engineering
808	Sonderanfertigungen	Pièces spéciales	Special designed products
809	Baugruppen	Assemblages	Pre-assembled kits
810	Konfektionierte Leitungen	Tubes pré-montés	Ready-to-fit pipes

Produktgruppe Famille de produits Product group	Optionen / Options / Options						
Messing M / Laiton M / Brass M	✓	✓	✓	✓	✓	✓	✓
Messing CV / Laiton CV / Brass CV	✓	✓	✓	✓	✓	✓	✗
Messing G / Laiton G / Brass G	✓	✓	✓	✓	✓	✓	✓
Edelstahl / Acier inoxydable / Stainless steel	✓	✓	✓	✗	✓		
Aluminium	✗	✗	✗	✗	✗		
Stahl / Acier / Steel	✗	✗	✗	✓	✓		
PVDF	✗	✗	✗	✗	✗		
PA	✗	✗	✗	✗	✓		
Flip	✗	✗	✗	✗	✗		
Ventile / Vannes / Valves							
Messing M/G / Laiton M/G / Brass M/G	✓	✓	✓	✓	✓	✓	✓
Edelstahl / Acier inoxydable / Stainless steel	✓	✓	✓	✗	✓		
Stahl / Acier / Steel	✗	✗	✗	✓	✓		
PVDF	✗	✗	✗	✗	✗		
PA	✗	✗	✗	✗	✓		
Stecktüllen / Douilles cannelées / Hose nipples							
Messing CV / Laiton CV / Brass CV	✓	■	■				
PVDF	✗	✗	✗				
Verteilerleisten / Distributeurs / Manifolds	auf Anfrage / sur demande / on request						
Adapter / Adaptateurs / Adaptors							
Messing M/G / Laiton M/G / Brass M/G	✓	■	■	✓	✓	✓	✓
Edelstahl / Acier inoxydable / Stainless steel	✓	■	■	✗	✓		
Aluminium	✗	✗	✗	✗	✗		
PVDF / PA	✗	✗	✗	✗	✗		
Rohre, Schläuche / Tubes, Tuyaux / Tubes, Hoses	✗	✗	✗				
Jacoflon	✗	✗	✗				
Schnellkupplungen / Coupleurs rapides / Quick couplings							
Inox Serie 50 / Inox Série 50 / Inox Series 50	✗	✓	✓				
Inox Serie 51 / Inox Série 51 / Inox Series 51	✗	✓	✓				
PVDF Sicherheitskuppl. / PVDF coupl. de sécurité / PVDF safety coupl.	✗	✓	✓				
PVDF Kupplung Plus / PVDF accouplement Plus / PVDF copuling Plus	✗	✓	✓				

Verträglichkeitsmatrix Matrice de compatibilité Compatibility matrix				
	✗	✗	✓	✓
	✗	✓	✓	✓
	✓	✓	✓	✗

- ✓ erhältlich
disponible
available
- erhältlich als US, da ungeschmiert
disponible en exécution US car non
lubrifié
available as US since no lubricant
necessary
- ✗ nicht möglich
ne pas disponible
not available



Spezialreinigung – entfettet – ungeschmiert

Nettoyage spécial – dégraissé

Special cleaning – degreased – unlubricated



Anwendungsgebiet

Überall, wo eine spezielle Oberflächensauberkeit der medienberührten Teile benötigt wird, der Kunde aber sein eigenes Schmiermittel verwenden möchte.

Qualität

Oberflächen Sauberkeit
 < 33 mg/m² TOC gem. ASTM*
 G93, Level B.
 Jeder Auftrag ist rückverfolgbar;
 Montage und Prüfung im Reinraum.

*American Society for Testing and materials

Lieferumfang

- einzelverpackt in verschweissten PE-Beuteln
- Spezial-Etikett
- unmontiert d.h. lose Mutter und Klemmring

Wichtiger Hinweis

Die Teile sind grösstenteils ungeschmiert, einzelne Stellen müssen aus funktionstechnischen Gründen geschmiert werden.
 Vor der Montage müssen Mutter und Klemmring unbedingt mit einem geeigneten Schmiermittel geschmiert werden.

Sortiment

Verschraubungen und Ventile aus:
 - Messing M/G/CV
 - Edelstahl
 Andere Produkte auf Anfrage.

Bestellhinweis

SERTO-Produkte, die entfettet und ungeschmiert geliefert werden sollen, müssen bei der Bestellung klar mit der Erweiterung **US** nach der Materialnummer oder der Materialbezeichnung gekennzeichnet sein.

Beispiel: SO 51121-8-1/4 US
 oder 058.1101.170.US

Champ d'application

Tout usage nécessitant une propreté spécifique des pièces en contact avec les médias, là ou le client applique son propre lubrifiant.

Qualité

Propreté de surface
 < 33 mg/m² TOC selon ASTM*
 G93, Level B.
 Chaque commande est identifiable;
 montage et contrôle en salle blanche.

*American Society for Testing and materials

Livraison

- emballés individuellement dans des sachets PE soudés
- étiquettes spéciales
- non assemblé avec écrou et bague de serrage séparés

Indication importante

Les composants sont dans leur plus grande partie non lubrifiés, en raison de fonctionnalité certaines parties doivent être lubrifiées.
 Il est impératif de lubrifier l'écrou et la bague de serrage avant le montage avec un lubrifiant adapté.

Assortiment

Raccord et vannes en:
 - laiton M/G/CV
 - acier inoxydable
 Autres produits sur demande.

Référencement de commande

Les produits SERTO à fournir dégraissés et non lubrifiés sont à référencer dans la commande avec la mention **US** après le numéro matériel ou après la désignation du matériel.

exemple: SO 51121-8-1/4 US
 ou 058.1101.170.US

Application area

Wherever special surface cleanliness is required for parts that come into contact with the media, but where the customer wishes to use his own lubricant.

Quality

Surface cleanliness
 < 33 mg/m² TOC as per ASTM*
 G93, Level B.
 Every order is traceable; assembly and testing are done in the clean room.

*American Society for Testing and materials

Scope of supply

- individually packaged in heat-sealed PE bags
- special label
- not assembled, i.e. loose nut and compression ferrule

Important information

The parts are generally not lubricated, however certain points must be lubricated for optimal functioning.
 Prior to assembly, the nut and the compression ferrule must be lubricated with a suitable lubricant.

Product range

Unions and valves in:
 - brass M/G/CV
 - stainless steel
 Other products on request.

Ordering information

SERTO products which need to be supplied degreased and unlubricated must be clearly marked with **US** after the material number or the material description when ordering.

e.g.: SO 51121-8-1/4 US
 or 058.1101.170.US

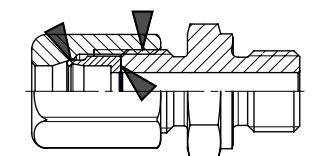
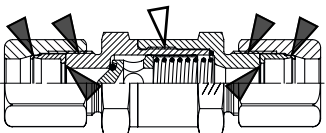
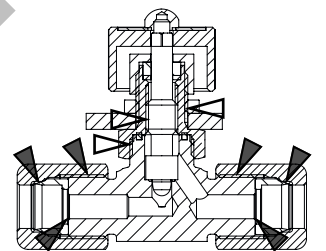

▶ vor Installation schmieren
 à lubrifier avant l'installation
 lubricate before installation

▷ bereits mit AC 851-OX geschmiert
 déjà lubrifié avec AC 851-OX
 already lubricated with AC 851-OX

Spezialbehandlung für Einsatz mit Sauerstoff (öl- und fettfrei)

Traitement spécial pour utilisation sous oxygène (exempt d'huile et de graisse)

Special treatment for use with oxygen (oil- and grease-free)



Anwendungsgebiet

Rohrverbinder und Armaturen, die in Sauerstoffsystemen zum Einsatz gelangen, unterliegen hohen Sauberkeitsanforderungen. Speziell, was die Menge der Kohlenstoffverbindungen auf der Oberfläche (Öle u. Fette) betrifft. Derartige Verunreinigungen können sich sehr einfach und schnell selbst entzünden.

Qualität

Oberflächen Sauberkeit
< 33 mg/m² TOC gem. ASTM*
G93, Level B.

Jeder Auftrag ist rückverfolgbar;
Montage und Prüfung im Reinraum.

*American Society for Testing and materials

Lieferumfang

- einzelverpackt in verschweissten PE-Beuteln
- Spezial-Etikett
- einbaufertig vormontiert
- initial geschmiert

Schmierstoff

Spezialschmierstoff AC 851 OX,
getestet von der BAM*
(Details s. Kapitel 21)

* Bundesanstalt für Materialforschung und -prüfung

Sortiment

Verschraubungen und Ventile aus:
- Messing M/G/CV
- Edelstahl
Andere Produkte auf Anfrage.

Bestellhinweis

SERTO-Produkte, die öl- und fettfrei geliefert werden sollen, müssen bei der Bestellung klar mit der Erweiterung **OX** nach der Materialnummer oder der Materialbezeichnung gekennzeichnet sein.

Beispiel: SO 51121-8-1/4 OX
oder 058.1101.170.OX

Champ d'application

Les exigences de propreté des systèmes de raccordements et vannes utilisés dans des circuits d'oxygène sont très élevées, surtout en ce qui concerne le nombre des carbures en surface (huiles et graisses). De telles impuretés peuvent s'enflammer facilement et vite.

Qualité

Propreté de surface
< 33 mg/m² TOC selon ASTM*
G93, Level B.

Chaque commande est identifiable;
montage et contrôle en salle blanche.

*American Society for Testing and materials

Livraison

- emballés individuellement dans des sachets PE soudés
- étiquettes spéciales
- pré-monté et prêt au montage
- graissage initial

Lubrifiant

Lubrifiant spécial AC 851 OX,
testé du BAM*
(détails voir chapitre 21)

* Bundesanstalt für Materialforschung und -prüfung

Assortiment

Raccords et vannes en:
- laiton M/G/CV
- acier inoxydable
Autres produits sur demande.

Référencement de commande

Les produits SERTO à fournir exempt d'huiles et des graisses sont à référencer avec la mention **OX** après le numéro matériel ou la désignation du matériel.

Exemple: SO 51121-8-1/4 OX
ou 058.1101.170.OX

Application area

Tube connectors and valves which are used in oxygen systems have very high cleanliness requirements, especially in regard to carbon compounds on the surface (oils and greases). Such contamination could self-ignite very easily and very quickly.

Quality

Surface cleanliness
< 33 mg/m² TOC as per ASTM*
G93, Level B.

Every order is traceable; assembly and testing are done in the clean room.

*American Society for Testing and materials

Scope of supply

- individually packaged in heat-sealed PE bags
- special label
- pre-assembled, ready for installation
- initial lubrication

Lubricant

Special lubricant AC 851 OX,
tested by BAM*
(details see chapter 21)

* Bundesanstalt für Materialforschung und -prüfung

Product range

Unions and valves in:
- brass M/G/CV
- stainless steel
Other products on request.

Ordering information

SERTO products which need to be supplied oil- and grease-free must be clearly marked with **OX** after the material number or the material description when ordering.

e.g.: SO 51121-8-1/4 OX
or 058.1101.170.OX



Spezialbehandlung – silikonfrei

Traitement spécial – sans silicone

Special treatment – silicone-free



Anwendungsgebiet

Rohrverbinder und Armaturen, die vornehmlich mit Farben und Lacken in Kontakt kommen, dürfen auf der medienberührten Oberfläche keine Silikonverbindungen aufweisen, da diese die Benetzung der Oberfläche verhindern.

Qualität

Oberflächen Sauberkeit
< 33 mg/m² TOC gem. ASTM*
G93, Level B.

Jeder Auftrag ist rückverfolgbar;
Montage und Prüfung im Reinraum.

* American Society for Testing and materials

Der gesamte Fertigungsprozess ist silikonfrei.

Lieferumfang

- einzelverpackt in verschweissten PE-Beuteln
- Spezial-Etikett
- einbaufertig vormontiert
- initial geschmiert

Schmierstoff

Wo notwendig, wird ein garantiert silikonfreier Schmierstoff verwendet.

Sortiment

Verschraubungen und Ventile aus:
- Messing M/G/CV
- Edelstahl
Andere Produkte auf Anfrage.

Bestellhinweis

SERTO-Komponenten, die silikonfrei geliefert werden sollen, müssen bei der Bestellung klar mit der Erweiterung **SI** nach der Materialnummer oder der Materialbezeichnung gekennzeichnet sein.

Beispiel: SO 51121-8-1/4 SI
oder 058.1101.170.SI

Champ d'application

Les raccords et vannes en contact avec des peintures et des lasures doivent être exempts de traces de silicone, qui empêcheraient le mouillage de la surface.

Qualité

Propreté de surface
< 33 mg/m² TOC selon ASTM*
G93, Level B.

Chaque commande est identifiable;
montage et contrôle en salle blanche.

* American Society for Testing and materials

Tout le processus de fabrication est exempt de silicone.

Livraison

- emballés individuellement dans des sachets PE soudés
- étiquettes spéciales
- prémonté et prêt au montage
- graissage initial

Lubrifiant

En cas de nécessité un lubrifiant libre de silicone est utilisé.

Assortiment

Raccords et vannes en:
- laiton M/G/CV
- acier inoxydable
Autres produits sur demande.

Référencement de commande

Les composants SERTO à fournir exempts de silicone sont à référencer avec la mention **SI** après le numéro du matériel ou la désignation du matériel:

exemple: SO 51121-8-1/4 SI
ou 058.1101.170.SI

Application area

Tube connectors and valves which primarily come into contact with paints and varnishes may not have any silicone compounds on the media-contacting surfaces because these would prevent wetting of the surfaces.

Quality

Surface cleanliness
< 33 mg/m² TOC as per ASTM*
G93, Level B.

Every order is traceable; assembly and testing are done in the clean room.

* American Society for Testing and materials

The whole production process is silicone-free.

Scope of supply

- individually packaged in heat-sealed PE bags
- special label
- pre-assembled, ready for installation
- initial lubrication

Lubricant

Where necessary, a guaranteed silicone-free lubricant is used.

Product range

Unions and valves in:
- brass M/G/CV
- stainless steel
Other products on request.

Ordering information

SERTO components which need to be supplied silicone-free must be clearly marked with **SI** after the material number or the material description when ordering.

e.g.: SO 51121-8-1/4 SI
or 058.1101.170.SI



Vorbeschichtete Einschraubgewinde mit PTFE-Band umwickelt

Filetage pré enduits avec ruban en PTFE

Pre-coated threads with PTFE-tape



Anwendungsgebiet

Die Alternative zur Option CT, die PTFE-Band-Umwicklung, eignet sich speziell

- bei Temperaturen über +150 °C
- bei aggressiven Medien
- bei Dampf
- für reinen Sauerstoff

Qualität

Die Gewinde sind aus Gründen der besseren Haftung teilweise aufgerauht. Das 0.08 mm dicke PTFE-Band wird mind. 5x umwickelt wobei der erste Gewindegang frei bleibt.

Lieferumfang

- in Standardverpackungen
- einbaufertig vormontiert
- initial geschmiert

Sortiment

Komponenten mit konischen Aussengewinden aus:

- Messing M/G/CV
- Stahl

Andere Produkte auf Anfrage.

Bestellhinweis

SERTO-Produkte, die mit umwickelten Gewinden geliefert werden sollen, müssen bei der Bestellung klar mit der Erweiterung **CP** nach der Materialnummer oder der Materialbezeichnung gekennzeichnet sein.

Beispiel: SO 41121-8-1/4 CP
oder 018.1101.170.CP

Champ d'application

Une alternative à l'option CT, est le revêtement de PTFE, autorisant l'utilisation à

- des températures au dessus de +150 °C
- avec des médias agressifs
- avec de la vapeur
- avec de l'oxygène pur

Qualité

Pour une meilleure adhésion les filetages seront rendus partiellement rugueux. La bande PTFE de 0.08 mm d'épaisseur sera posée en cinq couches au moins, en laissant libre le premier tour de filetage.

Livraison

- en emballage standard
- prémonté, prêt au montage
- graissage initial

Gamme

Disponible avec les filetages extérieurs coniques pour:

- laiton M/G/CV
- acier

D'autres produits sur demande.

Référencement de commande

Les produits SERTO à livrer avec des filetages revêtus sont à référencer lors des commandes avec la mention **CP** après le numéro ou la désignation du produit.

exemple: SO 41121-8-1/4 CP
ou 018.1101.170.CP

Application area

As an alternative to the CT option, PTFE tape is especially suitable

- for temperatures above +150 °C
- for aggressive media
- for steam
- for pure oxygen

Quality

The threads are roughened for better adhesion. The 0.08mm thick PTFE tape is wrapped at least 5x, while keeping the first screw thread free.

Scope of supply

- in standard packaging
- pre-assembled, ready for installation
- initial lubrication

Product range

Components with tapered external thread:

- brass M/G/CV
- steel

Other products on request.

Ordering information

SERTO products which need to be supplied with wrapped threads must be clearly marked with **CP** after the material number or the material description when ordering.

e.g.: SO 41121-8-1/4 CP
or 018.1101.170.CP



Vorbeschichtete Gewinde mit Loctite 5061

Filetages pré enduits avec Loctite 5061

Pre coated threads with Loctite 5061



Durch vorbeschichtete Gewinde erreichen Sie eine optimale Abdichtung von konischen Aussengewinden.

Das wasserbasierte, nichthärtende und nichttoxische Gewindedichtmittel Loctite® 5061 wird maschinell aufgetragen. Auf diese Weise ist sichergestellt, dass die Dichtmasse gleichmäßig und direkt bei den potentiellen Leckagestellen im Gewindegrund und auf den Gewindeflanken aufgebracht wird. Dadurch wird optimal für höchste Dichtheit und Sicherheit gesorgt. Vorbeschichtete Gewinde von SERTO sind vielseitig einsetzbar.

- Dichtmittel Loctite® 5061 Dri-Seal®
- Montagefertig
- Umweltfreundlich
- Ungiftig, lösungsmittelfrei
- Sehr gute Medienbeständigkeit

Technische Daten *

- Chemische Basis: Polyacrylat wässrig, nicht härtend
- Temperatur: -50 °C bis +150 °C
- Druck (PN): 16 bar, andere Drücke möglich
- Justierbarkeit: 45° (DIN 30660)
- Einsatzmedien: Luft, Öl, Wasser (heiss, kalt)

Hinweis: Loctite® 5061 ist nicht geeignet für den Einsatz mit reinem Sauerstoff. Weitere Informationen erhalten Sie von Ihrem Händler.

*Die Angaben stammen vom Hersteller von Loctite® 5061. Änderungen sind vorbehalten. Die Klärung der Einsatztauglichkeit von beschichteten Gewinden der SERTO liegt in der Verantwortung des Konstrukteurs und muss vorgängig geprüft werden. SERTO lehnt jegliche Haftung ab.

Bestellhinweis

SERTO-Produkte, die mit beschichteten Gewinden geliefert werden sollen, müssen bei der Bestellung klar mit der Erweiterung **CT** nach der Materialnummer oder der Materialbezeichnung gekennzeichnet sein.

Beispiel: SO 51121-8-1/4 CT
oder 058.1101.170.CT

Avec des filetages déjà revêtus, vous atteignez une étanchéité optimale des filetages coniques mâles.

La couche d'étanchéité pour filetages Loctite® 5061, à base d'eau, élastique et non toxique, est appliquée à la machine. Ainsi, la matière assurant l'étanchéité s'applique de manière homogène et régulière directement aux endroits de fuites potentielles au fond et sur les flancs du filetage et elle assure ainsi une étanchéité et une sécurité optimales. Les filetages revêtus au préalable par SERTO permettent des utilisations variées.

- Couche d'étanchéité Loctite® 5061 Dri-Seal®
- Prêt au montage
- Respectueux de l'environnement
- Non toxique, exempt de solvants
- Très bonne résistance aux fluides

Caractéristiques techniques *

- Base chimique: Polyacrylate aqueux, non durcissant
- Température: -50 °C bis +150 °C
- Résistant à la pression: 16 bar, autres pressions possibles
- Possibilité de réglage: 45° (DIN 30660)
- Fluides admis: air, huile, eau (chaude, froide)

Remarque: Loctite® 5061 ne convient pas pour l'emploi avec de l'oxygène pur. Pour plus d'informations contactez votre distributeur.

*Les indications proviennent du producteur de Loctite® 5061. Sous réserve de modifications. La pertinence d'utilisation des filetages enduits par SERTO relève totalement de la responsabilité de l'utilisateur et doit être vérifiée au préalable. SERTO décline toute responsabilité.

Référencement de commande

Les produits SERTO à livrer avec des filetages enduits sont à référencer lors des commandes avec la mention **CT** après le numéro matériel ou la désignation du matériel.

exemple: SO 51121-8-1/4 CT
ou 058.1101.170.CT

With precoated threads you obtain optimal sealing of tapered outside threads.

The water-based, non-hardening, non-toxic sealing compound Loctite® 5061 is applied by machine. This assures that the sealing compound is applied evenly and directly at potential leakage points at the base and the flank of the thread, thus providing extreme leak-tightness and reliability. Precoated threads from SERTO may be used in a wide variety of applications.

- Loctite® 5061 Dri-Seal® Sealing Compound
- Ready for assembly
- Environmentally friendly
- Non-toxic, solvent-free
- Very good media resistance

Technical Data *

- Chemical base: Polyacrylate, aqueous, non-hardening
- Temperature: -50 °C to +150 °C
- Pressure (PN) 16 bar, others possible
- Adjustability: 45° (DIN 30660)
- Media: air, oil, water (hot, cold)

Note: Loctite® 5061 is unsuitable for use with pure oxygen. Further information can be obtained from your distributor.

*The data comes from the manufacturer of Loctite® 5061. These are subject to change without notice. Clarification of the suitability for use of coated threads from SERTO is the responsibility of the designer and must be carried out in advance. SERTO will accept no liability there after.

Ordering information

SERTO products which need to be supplied with coated threads must be clearly marked with **CT** after the material number or the material description when ordering.

e.g.: SO 51121-8-1/4 CT
or 058.1101.170.CT

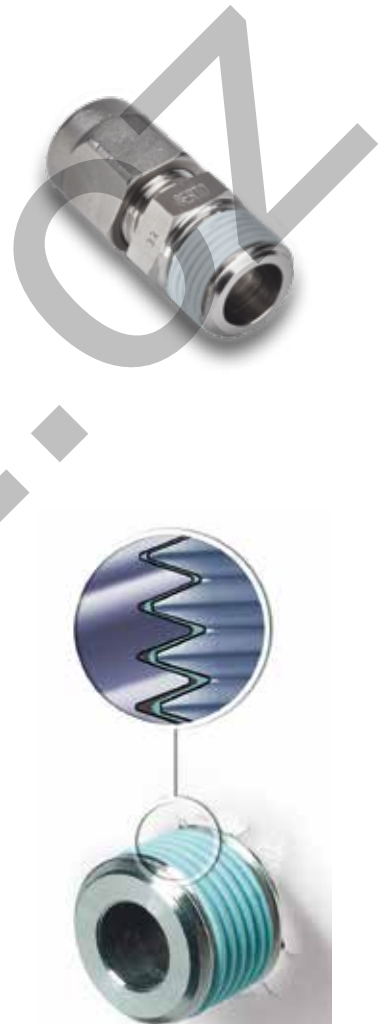

Chemische Vernickelung für Messing

Nickelage chimique pour laiton

Chemical nickel plating for brass



Bei der chemischen Vernickelung ist im Gegensatz zum elektrolytischen Prozess der Nickelüberzug vollständig planparallel herstellbar.

Unabhängig von der Oberflächenform des Werkstückes stellt sich immer eine durchgehend gleichmässige Schichtdicke ein. Damit werden konstruktive Masse konstant nur um das Mass der Schichtstärke verändert.

Die chemische Vernickelung geht eine starke Verbindung mit dem Messing-Gefüge ein und ergibt so eine höchst dauerhafte Veredelung.

Für SERTO Verschraubungen bedeuten diese Eigenschaften:

- grössere Oberflächenhärte
- verbesserte Beständigkeit im Vergleich mit Messing gegen Korrosion, Abrieb und Verschleiss

Anwendungen

Praktisch alle SERTO-Produkte aus Messing lassen sich chemisch vernickeln.

Typische Einsatzgebiete sind Rohrleitungen in leicht aggressiver oder korrosiver Umgebung, z.B. mit Seewasser, leichten Säuren, Öl-/Luft-Gemische, Apparatebau für Labors mit DI-Wasser oder für Lebensmittel etc.

Wichtig!

Chemisch vernickelte Verschraubungen können im Einzelfall als günstigere Variante zu Edelstahl eingesetzt, jedoch keinesfalls als allgemeine Alternative betrachtet werden.

Jede Anwendung ist unter Berücksichtigung der Einsatzbedingungen (Druck, Medium, Temperatur, Umgebung, etc.) individuell abzuklären. Wir empfehlen bei Bedarf vorgängig eigene Tests durchführen oder sich unter Angabe der genauen Einsatzbedingungen an uns zu wenden.

Contrairement au procédé de nickelage électrolytique, le nickelage chimique assure une dépose uniforme du nickel (faces planes et parallèles) sur la pièce traitée.

L'épaisseur déposée est constante, indépendamment de la forme de la pièce. Ainsi, les dimensions se trouvent modifiées que de façon constante par de la couche du nickel de l'épaisseur.

Le nickelage chimique assure une liaison particulièrement stable avec la structure du laiton, et appou une grande fiabilité du matériau.

En ce qui concerne les raccords SERTO, ces propriétés se traduisent par les caractéristiques suivantes:

- dureté en surface plus élevée
- meilleure résistance à la corrosion, à l'abrasion et à l'usure par rapport au laiton

Applications

Presque tous les produits SERTO en laiton peuvent être nickelés chimiquement.

Les domaines d'application typique sont les tuyauteries dans des milieux légèrement agressifs ou environnements corrosifs, p. ex. l'eau de mer, les acides faibles, les mélanges huile/air, les appareils de laboratoire avec l'eau déminéralisée ou pour les applications alimentaires, etc.

Important!

Dans certains cas d'application, les raccords nickelés peuvent représenter une variante plus économique que les alliages inoxydables. En revanche, ils ne peuvent en aucun cas être considérés comme une alternative globale.

Chaque utilisation devra donc tenir compte des conditions d'utilisation individuelles (pression, fluide, température, environnement, etc.). Il est conseillé d'effectuer, si nécessaire, des tests préalables, ou le cas échéant, de prendre contact avec nous, en indiquant de façon précise les conditions d'utilisation.

By contrast to the electrolytic nickel plating process, chemical nickel plating can be done completely plane-parallel.

Irrespective of the surface shape of the workpiece, a uniform plating thickness is always achieved over the entire surface. By that, the constructional dimensions will be changed only by the thickness of the plating layer.

The chemical nickel plating strongly bonds with the brass material structure and achieves a highly durable improvement.

For SERTO screwed joints these characteristics mean:

- higher surface hardness
- improved resistance against corrosion, abrasion and wear compared to brass

Applications

Practically all brass products of SERTO can be chemically nickel plated.

Typical areas of application are tubing in a slightly aggressive or corrosive environment, e.g. seawater, light acids, oil-air mixtures, laboratory apparatus manufacture for deionised water or for food etc.

Important!

Chemically nickel-plated tube unions can be used as a more favourable alternative to stainless steel in individual cases, but under no circumstances as a general alternative.

Each application has to be individually clarified under the conditions of operation (pressure, medium, temperature, environment, etc.). If necessary, we recommend to carry out own tests beforehand or to consult us with exact details of the operating conditions.

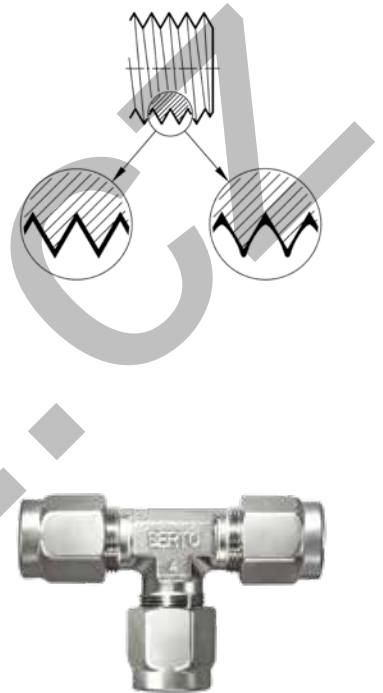

Messing bleiarm

Laiton à faible teneur en plomb

Low-lead brass



Dienstleistung

SERTO bietet Teile der Sortimente Messing M und Messing G an, bei denen der Bleigehalt an den Oberflächen stark reduziert wurde und somit deutlich unter den Grenzwerten aktueller Vorschriften liegt. Die Bleianteile werden an der Werkstückoberfläche durch einen speziellen Reinigungsprozess ausgewaschen.

Anwendungsgebiet

Die bleiarmlen Messingprodukte finden ihren Einsatz in anspruchsvollen Anwendungen im Trinkwasserbereich, in Kaffeemaschinen und in der Lebensmittelindustrie.

Sortiment

- Alle Produkte der Sortimente Messing M und Messing G
- Bei bleiarmlen Messingprodukten werden medienunberührte Teile, wie Muttern oder Ventilhandräder, aus dem Standardsortiment verwendet.

Normen

SERTO Produkte aus Messing erfüllen u.a. die in Deutschland 2011 neugefasste Verordnung über die Qualität von Wasser für den menschlichen Gebrauch (Trinkwasserverordnung – TrinkwV 2001), die der Umsetzung der Richtlinie 98/83/EG dient. Dementsprechend werden auch andere/nationale Vorschriften und Verordnungen problemlos eingehalten.

Bestellhinweis

- Mindestbestellmenge 100 Stück
- Geringere Mengen auf Anfrage
- SERTO-Produkte aus Messing mit reduziertem Bleigehalt müssen bei der Bestellung klar mit der Erweiterung **BA** (bleiarm) nach der Materialbezeichnung gekennzeichnet werden.

Beispiel: SO 41121-8-1/4 BA
oder 018.1101.170.BA

Services

SERTO propose des pièces des gammes laiton M et laiton G dont la teneur en plomb en surface a été fortement réduite pour atteindre un niveau largement inférieur aux valeurs limites des prescriptions en vigueur. La quantité de plomb sur les surfaces des pièces à usiner a été retirée grâce à un processus de nettoyage spécial.

Domaine d'application

Les produits en laiton à faible teneur en plomb sont utilisés dans des applications exigeantes liées à l'eau potable, les machines à café et l'industrie agro-alimentaire.

Gamme

- Tous les produits des gammes laiton M et laiton G
- Pour les produits en laiton à faible teneur en plomb, des pièces sans contact avec le produit, comme des écrous ou des volant des robinets, produits de la gamme standard sont utilisés.

Normes

Les produits SERTO en laiton répondent, entre autres, à l'ordonnance allemande révisée en 2011 sur la qualité des eaux destinées à la consommation humaine (décret sur l'eau potable – TrinkwV 2001) qui permet d'appliquer la directive 98/83/CE. D'autres directives et ordonnances nationales sont également respectées sans problème.

Indications de commande

- Quantité de commande minimum 100 pièces
- Quantités inférieures sur demande
- Les produits SERTO en laiton à faible teneur en plomb doivent être clairement indiqués sur la commande à l'aide de l'extension **BA** (à faible teneur en plomb) conformément à la désignation des matériaux.

exemple: SO 41121-8-1/4 BA
ou 018.1101.170.BA

Services

SERTO offers parts of the ranges Brass M and Brass G, in which the lead content of the surfaces has been greatly reduced and is therefore considerably lower than the limiting values according to the current regulations. The lead content is leached out of the surface of the workpiece by means of a special cleaning process.

Field of application

The low-lead brass products are used for demanding application in the field of drinking water, coffee machines and in the food industry.

Range

- All products in the ranges Brass M and Brass G
- In low-lead brass products, components that are not in contact with the medium, such as nuts and valve handwheels, are used from the standard range.

Standards

SERTO brass products fulfil the 2011 German revised regulation for the quality of water for human consumption (Drinking Water Regulation – TrinkwV 2001), which implements the Directive 98/83/EU. Accordingly, other/national regulations and ordinances are fulfilled without problems.

Order information

- Minimum order quantity 100 pcs
- Smaller quantities on request
- SERTO low-lead brass products must be clearly identified in the order with the extension **BA** (low-lead) after the designation of the material.

e.g.: SO 41121-8-1/4 BA
or 018.1101.170.BA



Engineering Ingénierie Engineering

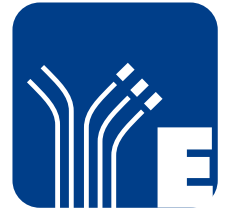

Passgenaue Lösungen für Sie – entwickelt von SERTO Engineering

Beratung

Wir beraten Sie kompetent und mit großer Erfahrung in der Produktentwicklung. Sie bekommen von uns Lösungsvorschläge, die in der harten Realität bestehen können. Ihr Vorteil - unsere Erfahrung!

Engineering

Wir entwickeln für Sie passgenaue Produkte – zusammen mit Ihnen, wenn Sie wollen. Damit nur einwandfreie Ware unser Haus verlässt, prüfen wir alles vorher in unserem eigenen Labor. Sie erhalten nur einwandfreie und geprüfte Waren. Ihre Idee – unser Engineering!

Optimierte Produkte

Wir analysieren Ihre vorhandenen Produkte und spüren mögliches Optimierungspotenzial auf. Vielleicht lassen sich Fertigung und Montage oder die Herstellung vereinfachen. Sie erhalten dann durch ein Redesign optimierte Produkte. Ihre Einsparung – unsere Produktoptimierung!

L'ingénierie de SERTO développe des solutions sur mesure – pour vous aussi

Conseils

Notre longue expérience dans le développement de produits nous permet de vous conseiller avec compétence et de vous proposer des solutions qui répondent aux applications – notre expérience est votre avantage!

Ingénierie

En étroite collaboration et avec le soutien d'équipements de travail les plus modernes, nous vous développons des produits adaptés à vos besoins. Dans nos propres laboratoires, nous vérifions la qualité des composants afin d'assurer que seuls des marchandises irréprochables quittent nos établissements – vous apportez l'idée, et nous l'ingénierie!

Optimisations de produits

Nous analysons, optimisons et perfectionnons. Nous passons les produits existants à la loupe et nous examinons si leur fabrication et leur montage peuvent être optimisés. Nos améliorations de conception simplifient la fabrication de vos produits – avec les optimisations de produits de SERTO, vous économisez de l'argent!

SERTO Engineering develops tailor-made solutions – also for you

Consulting

Our many years experience in product development enables us to advise you in a knowledgeable, competent manner and to propose appropriate application solutions. – Our experience is your advantage!

Engineering

In close co-operation with you and supported by the latest technology, we can develop the right products for your specific requirements. The quality of the components is validated internally, to ensure that only top-grade products leave our works – You provide the idea, we provide the engineering!

Product streamlining

We analyse, optimise and redesign. Existing products are examined meticulously and tested to determine whether manufacture and assembly can be optimised. Our redesigns simplify the manufacture of your products – SERTO product streamlining saves you money!



Nutzen Sie bei der Konstruktion Ihrer Anlage unsere CAD-Bibliothek – serto.partcommunity.com

Utilisez notre bibliothèque CAO pour la construction de votre système – serto.partcommunity.com

Use our CAD library for the construction of your system – serto.partcommunity.com

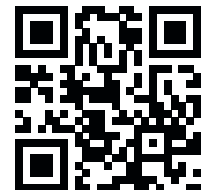

Sonderanfertigungen

Fabrications spéciales

Special designed products



Schwierige Verbindungsaufgaben – Sonderanfertigungen von SERTO

Herstellverfahren

Wir verfügen über modernst eingerichtete Produktions- und Bearbeitungswerkstätten. Dank unserer grossen Erfahrung im Pressen, Drehen, Fräsen oder Spritzen können wir Ihnen einwandfreie Produkte garantieren. Das schliesst auch vor- oder nachgelagerte Prozesse wie Löten, Schweiessen (auch Orbital) oder Oberflächenveredeln mit ein. Ihr Nutzen – unsere Vielseitigkeit!

Werkstoffe

Wir kennen uns in den Materialien aus. Vielfältige Herstellverfahren setzen auch Kenntnisse über die zu verarbeitenden Materialien voraus. Egal ob Buntmetall, Edelstahl, Sonderlegierungen oder Kunststoff, für jede Aufgabenstellung können wir das geeignete Material auswählen und verarbeiten. Sie erhalten den optimalen Werkstoff für Ihre Anwendung. Ihre Auswahl – unsere Materialvielfalt!

Funktionalität

Wir liefern unsere SERTO Produkte für den Maschinen- und Apparatebau genauso wie für die Lebensmittel-, Pharma- oder Hightechindustrie. Überall hat sich die grosse Funktionalität bewährt. Sie erhalten individuelle Lösungen für genau Ihre spezielle Anwendung. Ihr Einsatzbereich – unsere Funktionalität!

Pas de soucis dans les problèmes d'assemblage, grâce aux fabrications spéciales de SERTO

Process de fabrication

Grâce aux équipements les plus modernes de nos ateliers de production et d'usinage et à notre grande expérience du matriçage, du décolletage, du fraisage et de l'injection, nous pouvons vous garantir des produits irréprochables. Les processus qui précèdent ou suivent ces opérations, comme le brasage, le soudage (également orbital) ou les traitements de surface comptent aussi parmi nos compétences – notre polyvalence est votre avantage!

Matériaux

Les matériaux que nous utilisons sont aussi variés que nos procédés de fabrication. Que ce soient des métaux non ferreux, de l'acier inoxydable, les alliages spéciaux ou des matières plastiques, sous toutes les formes imaginables, nous utilisons nos connaissances pour leur usinage – une variété de matières plus importante que jamais!

Fonctionnalité

Les produits SERTO sont utilisés, en raison de leur spécificité, non seulement dans la construction de machines et d'appareils, mais aussi dans l'industrie alimentaire et pharmaceutique et d'autres domaines high-tech – une fonctionnalité optimisée, un maximum de possibilités d'applications!

The special designs from SERTO eliminate the problems that arise with connections

Manufacturing Process

Our hi-tech equipment in production and machining combined with our vast experience in pressing, turning, milling or injection moulding, enables us to guarantee you top-class products. Our other centres of excellence including brazing, welding (also orbital) and surface finishing offer you the complete manufacturing process – Our versatility is your advantage!

Materials

Our varied manufacturing processes enable us to deal with a variety of material specifications. Irrespective of whether it is non-ferrous metal, high-grade steel, special alloy or plastics, and whatever the form, we have the necessary knowledge for the manufacture – material diversity is more important than ever!

Functionality

Due to their individual nature, SERTO products can be found in a number of applications. These include mechanical engineering, food and beverage, water, heating and ventilation, pharmaceutical and other high-tech industries – optimized functionality, a maximum of application possibilities!



Baugruppen

Ensembles pré-montés

Pre-assembled kits



Komplexe Aufgaben lösen – mit Baugruppen von SERTO

Von der Planung bis zur Distribution

Wir führen einzelne Komponenten zu Baugruppen zusammen. Für Sie übernehmen wir dabei die Planung, Fertigung und die gesamte Distribution.

Ihr Termin – unsere Lieferung just in time!

Know-how

Wir haben das notwendige Know-how. Denn für unsere Kunden montieren wir täglich hunderte von Komponenten zu einbaufertigen Einheiten. Sie profitieren von unserem Wissen, denn das Gesamte ist mehr als die Summe der Einzelteile.

Ihre Baugruppen – unsere Montagekompetenz!

Kostenvorteil

Wir wollen mit unserer Baugruppenfertigung Ihre Zeit sparen. Sie sparen aber nicht nur wertvolle Montagezeiten. Auch die Disposition, Logistik und Lagerbewirtschaftung gestaltet sich wesentlich einfacher, was Ihnen Kosten gut tut.

Ihr Kostenvorteil – unsere Bestrebung!

Avec les sous-ensembles SERTO, vous résolvez d'un seul coup tous vos problèmes

Du projet au montage

Nous assemblons certains composants en sous-ensembles et nous nous chargeons pour vous du projet, de la fabrication et du montage – just in time, avec nous pour partenaire!

Savoir-faire

SERTO assemble chaque jour des centaines de composants en unités prêtes à monter. Nous possédons également le savoir-faire nécessaire – pour le montage de vos sous-ensembles!

Avantages économiques

Avec les sous-ensembles de SERTO, vous économisez non seulement un précieux temps de montage, mais la préparation, la logistique et la gestion des stocks deviennent beaucoup plus simples, ce qui se répercute positivement sur vos coûts – L'outsourcing, votre avantage économique!

With assemblies from SERTO, you solve all the problems in one hit

From planning to distribution

We fit individual components together to create assemblies. We undertake the planning, fabrication and distribution for you – Just in time with us as your partner!

Knowledge

SERTO assembles hundreds of components on a daily basis to form ready-to-fit units. We have many years knowledge of pre-assembly experience – We can do this for you!

Cost-Benefits

With assemblies from SERTO, you not only save valuable fitting time, but also simplifies the layout, logistics and inventory management and maintenance issues. This has a positive effect on reducing costs – Outsourcing, your cost-benefit!

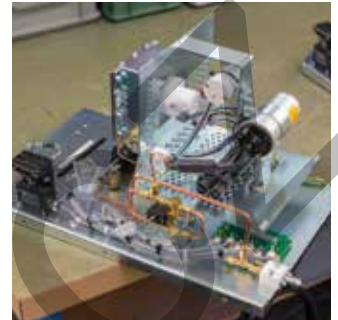

Konfektionierte Leitungen

Tubes pré-montés

Ready-to-fit pipes



Einbaufertige Leitungen – SERTO Top-Qualität

Ausführungen

Wir produzieren Ihre Rohrleitungen massgeschneidert, passgenau und einbaufertig. Sie wählen aus einer Vielzahl von Rohrumformungs- und Konfektionierungsmöglichkeiten aus – gelötet oder geschweisst, gebogen oder gewickelt.

Ihr Anruf – unsere Leitung!

Materialien

Wir bieten Ihnen gerne Rohre in den verschiedensten Variationen an. Sie können nicht nur Kupfer, sondern auch Messing- oder Edelstahlrohre bekommen. Oder sollen es gar warm verformte Kunststoffrohre sein? Wir machen es möglich.

Ihre Frage – unsere vielfältige Antwort!

Konfektionieren

Wir konfektionieren die gebogenen Leitungen nach Ihren Anforderungen und Wünschen. Sie bekommen Rohrleitungen, versehen mit SERTO Armaturen, die sich mühelos radial ein- und ausbauen lassen.

SERTO radial – einfach genial!

Avec SERTO, vous obtenez des tubes pré-formés dans la meilleure des qualités

Exécutions

Brasées ou soudées, cintrées ou enroulées, SERTO produit vos tubes sur mesure et prêts au montage. Vous avez la possibilité de choisir parmi une multitude de variantes de formes et de raccords – n'hésitez pas de nous appeler!

Matériaux

Il n'est pas nécessaire d'employer toujours des tubes de cuivre! Nous pouvons aussi vous proposer des tubes de laiton ou d'acier inoxydable dans les variantes les plus diverses. Vous avez peut-être besoin de tubes de plastique formés à chaud? Nous pouvons le faire – mettez-nous à l'épreuve!

Préfabrication

Nous assemblons des tubes cintrés et nous les équipons selon vos exigences et souhaits. Les tubes pré-équipés des raccords SERTO peuvent se monter et se démonter sans peine grâce au montage radial.

SERTO radial – simplement génial!

With SERTO you get top-quality, ready-to-fit pipes

Designs

Whether brazed or welded, curved or wound, SERTO produces your pipes in a customised, ready-to-fit state. You have the possibility to select from a multitude of pipe shapes and manufacturing processes – Give us a call!

Materials

Pipes don't have to be made only from copper! We can also offer you brass or high-grade steel pipes in a variety of different forms. Or do you require hot-formed plastic pipes? We can meet your specifications – Give us a try!

Ready-to-fit

We can assemble pipe work with SERTO fittings according to your specifications. Pipes with SERTO fittings can be installed or removed in a radial direction without difficulty. SERTO radial – simply ingenious!



Anhang

**Technische Erläuterungen
Beständigkeitsliste**

Appendice

**Explications techniques
Résistances chimiques**

Appendix

**Technical explanations
Chemical resistances**

KO

A

Anhang

Appendice

Appendix

Übersicht**Aperçu****Overview****Seite / Page / Page**

Technische Erläuterungen Explications technique Technical explanations	Spannungsrissskorrosion muss nicht sein! Évitez les fissures dues à la corrosion sous tension! There must be no corrosion which leads to stress related cracks!	813
Gewindebestimmung Identification des filetages Identification of threads		814
Dichtungswerkstoffe bei SERTO-Produkten Matériaux d'étanchéité des productions SERTO Sealing materials in SERTO Products		815 – 817
Beständigkeitsliste Résistance chimique Resistance to chemicals		818 – 829
Allgemeine Verkaufs- und Lieferbedingungen Conditions générales de vente et de livraison General terms of sale and delivery		830 – 834

Spannungsrissskorrosion muss nicht sein!

Unter Spannungsrissskorrosion versteht man eine chemische und/oder elektrochemische Korrosion eines Metalls unter gleichzeitiger Einwirkung eines Korrosionsmittels und mechanischer Spannungen.

Unter ungünstigen Einsatzbedingungen kann es zu Spannungsrissskorrosion kommen. Dabei treten plötzliche Risse am Bauteil auf, ohne dass es vorher erkennbare Zeichen gibt.

Damit es zu einem derart seltenen Schaden kommt, müssen jedoch drei Auslösefaktoren gleichzeitig eintreten:

- Feuchtigkeit aus der Umgebung
- Korrosionsmedium (meist Ammoniakverbindungen in grösserer Konzentration)
- Gefügespannungen/Zugspannungen im Bauteil

Die Ammoniakverbindungen in schädlicher Konzentration sind beispielsweise in Pumpenschächten, Unterputzinstallationen, in Landwirtschafts- und Galvanikbetrieben vorhanden. Die Möglichkeit einer Spannungsrissskorrosion ist schon deshalb nicht ganz auszuschliessen. Mit geeigneten Massnahmen kann Spannungsrissskorrosion jedoch vermieden werden.

Massnahmen beim Einbau

- Die Montage muss sorgfältig nach SERTO Anweisung erfolgen. Die Mutter darf nicht überzogen werden.
- Gemischte Werkstoffkombinationen von Verschraubungs- und Rohrmaterial sind zu vermeiden, zum Beispiel Messingverschraubungen mit INOX-Rohren.
- Ein äusserer Korrosionsschutz mit Schutzbändern, bzw. Schrumpfschläuchen nach DIN 30672-1, verhindert den Angriff durch Feuchtigkeit und Ammoniak.

Zum äusseren Korrosionsschutz von SERTO Verschraubungen besonders geeignet ist die SERTO-Bandage AC 860 (siehe Kapitel 21).

Die Spannungsrissskorrosion kann mit diesen Massnahmen wirksam verhütet werden. Die Kosten sind gering, im Vergleich zu den möglichen Schadenfolgen.

Unsere Fachleute beraten Sie gerne weiter.

Evitez les fissures dues à la corrosion sous tension

Les fissures dues à la corrosion résultent d'une corrosion chimique et/ou électrochimique d'un métal associé en même temps aux effets d'un agent corrosif et des tensions mécaniques.

Des conditions défavorables peuvent provoquer des corrosions sous tension. De là pourront se former brusquement des fissures sans indications préalables.

Pour qu'une telle détérioration apparaisse, trois facteurs déclenchant sont toutefois obligatoires:

- de l'humidité
- provenant de l'environnement (la plupart du temps des liaisons d'ammoniac en concentration élevée)
- des tensions structurelles dans la pièce.

On trouve des liaisons d'ammoniac en concentration dommageable dans des fosses à pompes, sur des installations sous crêpi, dans des exploitations agricoles et dans des entreprises de galvanisation. L'éventualité d'une corrosion de tension n'est donc pas à exclure. Celle-ci peut être évitée par des mesures appropriées.

Mesures à prendre lors de l'installation:

- Le montage est à faire soigneusement selon les instructions SERTO. Éviter de serrer l'écrou trop fort.
- Des combinaisons de différents matériaux sont à éviter, par exemple le montage des raccords en laiton avec des tuyaux en acier inoxydable.
- Une protection anti-corrosive avec des bandes de protection, respectivement des bandes de rétrécissement selon la norme DIN 30672-1 empêche l'attaque due à l'humidité et à l'ammoniaque

Le bandage SERTO AC 860 (voir le chapitre 21) est particulièrement adapté pour la protection anticorrosion extérieure des raccords SERTO.

Ces protections permettent de prévenir efficacement contre la corrosion sous tension. Les coûts sont faibles, surtout en comparaison avec les conséquences des dommages.

C'est avec plaisir que nos spécialistes vous conseilleront.

There must be no corrosion which leads to stress related cracks!

As corrosion which leads to stress related cracks, we understand the chemical or electrochemical corrosion of a metal under simultaneous influence of a corrosion agent and mechanical tension.

Under unfavourable conditions of operations, corrosion leading to stress related cracks may occur. Without any previously perceptible signs, the cracks unexpectedly appear on the component.

Three conditions have to happen simultaneously, however, to trigger such a rare occurrence of damage:

- Humidity from the environment
- A corrosion medium (mostly ammonia compounds in larger concentrations).
- Structural stress in the component

Ammonia compounds in harmful concentrations can, for example, be found in pump shafts, concealed installations, in agricultural and galvanic installations. The possibility of stress cracking corrosion cannot therefore be completely excluded. It can, however, be avoided by taking appropriate measures.

Installation measures

- The installation must be carried out, following exactly the SERTO instructions. The nut may not be over-tightened.
- Mixed material combinations of screwed joints and piping have to be avoided, for example: Screwed brass joints with inox pipes.
- External corrosion protection by means of protective tapes or shrink tubing, according to DIN 30672-1, avoids corrosion from humidity and ammonia.

For external corrosion protection of SERTO screwed joints it is particularly suitable to use the SERTO bandage AC 860 (see chapter 21).

Corrosion which leads to stress related cracks can be effectively avoided with these measures. The cost for this protection is low, compared to the possible consequences of damage.

Please consult our specialists for further information.



Aussengewinde Filetage mâle Male thread	Innengewinde Filetage femelle Female thread																																																		
	1 	2 	3 																																																
Metrisches ISO-Regelgewinde Filetage métrique ISO Metric thread	Metrisches ISO-Feingewinde Filetage métrique fin ISO Metric fine thread	Rohrgewinde BSPP Filetage-gaz BSPP BSPP Pipe thread	Rohrgewinde BSPT Filetage-gaz BSPT BSPT Pipe thread																																																
<table border="0"> <tr><td>M 3</td><td></td></tr> <tr><td>M 4</td><td></td></tr> <tr><td>M 5</td><td></td></tr> <tr><td>M 6</td><td></td></tr> <tr><td>M 8</td><td></td></tr> <tr><td>M 10</td><td></td></tr> <tr><td>M 12</td><td></td></tr> </table>	M 3		M 4		M 5		M 6		M 8		M 10		M 12		<table border="0"> <tr><td>M 10x1</td><td></td></tr> <tr><td>M 12x1</td><td></td></tr> <tr><td>M 14x1</td><td></td></tr> <tr><td>M 16x1</td><td></td></tr> <tr><td>M 16x1.5</td><td></td></tr> </table>	M 10x1		M 12x1		M 14x1		M 16x1		M 16x1.5		<table border="0"> <tr><td>G 1/8</td><td></td></tr> <tr><td>G 1/4</td><td></td></tr> <tr><td>G 3/8</td><td></td></tr> <tr><td>G 1/2</td><td></td></tr> <tr><td>G 3/4</td><td></td></tr> <tr><td>G 1</td><td></td></tr> </table>	G 1/8		G 1/4		G 3/8		G 1/2		G 3/4		G 1		<table border="0"> <tr><td>R 1/8</td><td></td></tr> <tr><td>R 1/4</td><td></td></tr> <tr><td>R 3/8</td><td></td></tr> <tr><td>R 1/2</td><td></td></tr> <tr><td>R 3/4</td><td></td></tr> <tr><td>R 1</td><td></td></tr> </table>	R 1/8		R 1/4		R 3/8		R 1/2		R 3/4		R 1	
M 3																																																			
M 4																																																			
M 5																																																			
M 6																																																			
M 8																																																			
M 10																																																			
M 12																																																			
M 10x1																																																			
M 12x1																																																			
M 14x1																																																			
M 16x1																																																			
M 16x1.5																																																			
G 1/8																																																			
G 1/4																																																			
G 3/8																																																			
G 1/2																																																			
G 3/4																																																			
G 1																																																			
R 1/8																																																			
R 1/4																																																			
R 3/8																																																			
R 1/2																																																			
R 3/4																																																			
R 1																																																			

Eigenschaften von Dichtungswerkstoffen bei SERTO-Produkten

Einleitung

Jeder Elastomerwerkstoff hat seine Einsatzgrenzen. Sei dies das Verhalten bei Wärme und Kälte, die Beständigkeit gegen Kontaktmedien oder Bewitterung oder die mechanischen Eigenschaften. Dazu kommen noch spezielle Eigenschaften, wie z.B. Lebensmittel und Medizinal-Verträglichkeit, radioaktive Beständigkeit, Eignung im Vakuum Einsatz, elektrische Eigenschaften etc. Ein Überschreiten der Einsatzgrenzen kann folgende Erscheinungen zeigen:

- Quellen oder Schrumpfen
- Aushärten oder Erweichen
- starke Verformung, Abplattung oder Aufdehnung
- Oberflächenrisse
- Mechanische Zerstörung
- Abrieb und Zerstörung

Da diese Veränderungen eine Folge von verschiedenen Kriterien wie Mediumsbeständigkeit, Temperatur, Druck und Einbauart sind, muss bei der Werkstoffwahl der bestgeeignete bestimmt werden. Oft sind jedoch gewisse Kompromisse nötig, da nicht alle Anforderungen an den Werkstoff erfüllt werden können.

Für eine sichere, störungsfreie Funktion muss bei der Auswahl eines Produkts die gesamte Systemauslegung berücksichtigt werden. Der Systemausleger und der Anwender sind für die Funktion der Produkte, ihre Materialverträglichkeit, entsprechende Leistungsdaten und Einsatzgrenzen sowie für die vorschriftsmässige Handhabung, den Betrieb und die Wartung verantwortlich.

NBR – Acrylnitril-Butadien-Elastomer

Die Kurzbezeichnung NBR ist abgeleitet von Nitrile Butadiene Rubber. NBR ist wegen der guten Beständigkeit gegen die meisten Öle und Fette auf Mineralölbasis der in der Dichtungstechnik am häufigsten eingesetzte Werkstoff. Der thermische Einsatzbereich liegt normalerweise zwischen -30°C und $+100^{\circ}\text{C}$, kurzzeitig bis $+130^{\circ}\text{C}$; bei höheren Temperaturen verhärtet der Werkstoff. Ausserdem zeigt NBR ein günstiges Alterungsverhalten und geringen Abrieb.

NBR ist beständig gegen Hydrauliköle, Wasserglykole und Öl in Wasser-Emulsionen, Mineralöle und Mineralölprodukte, tierische und pflanzliche Öle, Benzin, Heizöl, Wasser bis ca. $+70^{\circ}\text{C}$, Butan, Propan, Methan, Ethan. Stark quellend ist NBR bei aromatischen Kohlenwasserstoffen, z.B. Benzol, chlorierten Kohlenwasserstoffen (z.B. Trichlorethylen) Estern, polaren Lösungsmitteln wie Aceton sowie in Bremsflüssigkeiten auf Glykoletherbasis. NBR ist nicht ozonbeständig, bitte achten Sie bei der Lagerung auf den Schutz vor möglichen Ozon-Quellen.

FKM/FPM – Fluorkautschuk

Fluorelastomer zählt zu den bedeutendsten Werkstoffentwicklungen der 50er Jahre. Der Unterschied zwischen FPM und FKM liegt nur in der Bezeichnung: FPM (nach DIN / ISO) und FKM (nach ASTM). Der Ausgangswerkstoff ist FDA-konform (CFR 21, § 177.2600). Es ist auch unter dem Handelsnamen Viton® bekannt.

Propriétés des matériaux d'étanchéité des productions SERTO

Introduction

Chaque élastomère a ses valeurs limites. L'utilisation d'un élastomère peut être conditionnée par sa résistance au chaud et au froid, sa compatibilité avec le fluide en présence, sa résistance aux intempéries ou ses propriétés mécaniques.

N'oublions pas non plus les caractéristiques spécifiques telles que la compatibilité avec les produits alimentaires, la possibilité d'utilisation en milieu médical, la résistance aux irradiations ou au vide, les propriétés électriques, etc. Si les valeurs limites sont dépassées, les phénomènes suivants peuvent se manifester:

- gonflement ou rétrécissement
- durcissement ou ramollissement
- forte déformation, aplatissement ou allongement
- fissures superficielles
- dégradation mécanique
- abrasion et destruction

Comme ces altérations sont fonction de divers paramètres comme la compatibilité avec le fluide en présence, la température, la pression et le type de montage, il convient d'apporter un soin tout particulier au choix du matériau le mieux approprié. Bien souvent, certains compromis doivent cependant être trouvés lorsqu'un matériau ne peut répondre à toutes les exigences.

Pour un fonctionnement sûr et sans problème, il faut tenir compte de l'ensemble de la conception du système lors de la sélection d'un produit. Le concepteur du système et l'utilisateur sont responsables du fonctionnement des produits, de la compatibilité des matériaux, des données de performance correspondantes et des limites d'application, ainsi que de la manipulation, de l'utilisation et de la maintenance conformément aux réglementations.

NBR – Caoutchouc butadiène nitrile acrylique

L'abréviation NBR est dérivée de «nitril butadien rubber». Compte tenu de sa stabilité compatible avec les huiles et graisses sur base minérale, il est le matériau le plus largement utilisé pour les techniques d'étanchéité. La plage de températures d'utilisation se situe entre -30°C et $+100^{\circ}\text{C}$, à $+130^{\circ}\text{C}$ pour des séquences courtes. Aux températures plus élevées le matériau durcit. Par ailleurs le NBR bénéficie d'un bon vieillissement dans la durée ainsi que d'une usure moindre.

Le NBR résiste aux huiles hydrauliques, eaux glycosées, huiles dans les émulsions d'eau, aux huiles minérales et aux produits minéraux, aux huiles végétales et animales, à l'essence et au mazout, à l'eau jusqu'à environ $+70^{\circ}\text{C}$, aux butane, propane, méthane, éthane; le NBR gonfle fortement en présence d'hydrocarbures aromatiques, par exemple: benzol, solvants chlorés (trichloréthylène), esters, dissolvants polaires tels que l'acétone ainsi que les liquides de freins sur base éther glycol. Le NBR n'est pas résistant à l'ozone, veuillez assurer une protection contre les sources possibles d'ozone pendant le stockage.

FKM/FPM – Caoutchouc fluoré

Les élastomères fluorés comptent parmi les matières premières les plus développés durant les années 1950. La différence entre FPM et FKM réside uniquement dans la dénomination: FPM (selon DIN/ISO) et FKM (selon ASTM). Le matériau, in fine, a la conformité FDA (CFR 21 § 177.2600). Il est également connu sous le nom Viton®.

Properties of sealing materials in SERTO products

Introduction

Every elastomer material has its limits of use. Be it the behaviour at heat and cold, the resistance to contact media or weathering or the mechanical properties. There are also special properties, such as food and medical compatibility, radioactive resistance, suitability for use in a vacuum, electrical properties, etc. The following phenomena may occur if the limits are exceeded:

- swelling or shrinkage
- hardening or softening
- severe deformation, flattening or expansion
- surface cracking
- mechanical destruction
- wear and destruction

Since these changes are a result of various criteria such as resistance to the medium, temperature, pressure and type of installation, the most suitable material must be selected. However, certain compromises are often necessary, as not all requirements for the material can be met.

For safe, trouble-free operation, the entire system design must be taken into account when selecting a product. The system designer and the user are responsible for the functioning of the products, their material compatibility, corresponding performance data and application limits, as well as for handling, operation and maintenance in accordance with the regulations.

NBR – Acrylonitrile-Butadiene-Elastomer

The abbreviation NBR stands for Nitrile Butadiene Rubber. NBR is the most frequently used material in sealing technology because of its good resistance to most mineral oils and greases. The thermal range of application is normally between -30°C and $+100^{\circ}\text{C}$, short term up to $+130^{\circ}\text{C}$; at higher temperatures the material hardens. Additionally, NBR exhibits favourable ageing characteristics and low surface abrasion.

NBR is resistant to hydraulic oils, water glycols and oils in aqueous emulsions, mineral oils and mineral-oil products, animal and vegetable oils, benzene, fuel oil, water up to ca. $+70^{\circ}\text{C}$, butane, propane, methane, ethane. NBR swells greatly with aromatic hydrocarbons, e.g. benzene, chlorinated hydrocarbons (e.g. trichloroethylene), esters, polar solvents, such as acetone, as well as in glycol ether-based brake fluids. NBR is not ozone resistant, please ensure protection from possible ozone sources during storage.

FKM/FPM – Fluorocarbon rubber

Fluororubber figures among the most significant developments in materials technology of the 1950s. The difference between FPM and FKM is only the name: FPM (according to DIN/ISO) and FKM (according to ASTM). The initial material is FDA-compatible (CFR 21, § 177.2600). It is also known under the trading name Viton®.

Dichtungswerkstoffe

Fortsetzung

FKM zeichnet sich durch hohe Temperatur-, Witterungs-, Ozon- und Chemikalienbeständigkeit aus. Der thermische Anwendungsbereich reicht von -20°C bis $+200^{\circ}\text{C}$, kurzzeitig $+250^{\circ}\text{C}$.

FKM ist gegenüber fast allen Hydraulikflüssigkeiten auf Mineralölbasis und synthetischer Basis hoch beständig, ebenso gegen Ozon, Sauerstoff, Kraftstoffe, Aromate, viele organische Lösungsmittel und Chemikalien. Einschränkungen müssen für den Einsatz in Heisswasser, Dampf und bei Tieftemperaturen gemacht werden. Auf Grund nur geringer Kälteflexibilität und mässiger Heisswasser- und Dampfbeständigkeit sind für diesen Einsatz spezielle Werkstoffe zu wählen. Nicht beständig ist FKM ausserdem gegen polare Lösungsmittel wie Aceton, Bremsflüssigkeiten auf Glykolbasis, Ammoniakgas, Alkalien und niedermolekulare organische Säuren (Ameisensäure und Essigsäure).

EPDM – Ethylen-Propylen-Dien-Elastomer

EPDM Elastomere sind sehr alterungs- und witterungsbeständig, auch bei UV-Belastung und Ozonbelastung. Sie weisen geringe Wasserdampfdurchlässigkeit und extrem tiefe Versprödungstemperaturen auf. Wegen seiner hohen Elastizität und guten chemischen Beständigkeit wird EPDM für verschiedenste Dichtungen wie z.B. O-Ringe und Flachdichtungen verwendet. Die Einsatztemperatur liegt zwischen -40°C und $+160^{\circ}\text{C}$, kurzzeitig bis $+180^{\circ}\text{C}$.

EPDM hat eine ausgezeichnete Beständigkeit gegen Heisswasser und Wasserdampf und eine gute Beständigkeit gegen polare Flüssigkeiten wie Aceton, Methanol usw. Nicht beständig ist der Werkstoff gegenüber aliphatischen und aromatischen Kohlenwasserstoffen (Mineralöle, Benzin, Kraftstoffe) und Fetten.

FFKM/FFPM – Perfluorkautschuk

Chemisch ist FFKM dem Polytetrafluorethylen (PTFE) sehr ähnlich und verbindet die Elastizität und die Dichtungskraft eines echten Elastomers mit der chemischen Beständigkeit von PTFE. Verglichen mit reinen PTFE-Dichtungen zeigen FFKM-Teile kein Wegkriechen, kein Fließen und geringe bleibende Verformung. FFKM-Perfluor-Elastomer Teile bewahren ihre elastischen Eigenschaften im Langzeitbetrieb von bis zu $+315^{\circ}\text{C}$ und im periodischen Betrieb bis zu $+350^{\circ}\text{C}$ selbst in Berührung mit korrosiven Chemikalien.

Wegen seines vergleichsweise hohen kg-Preises ist der Einsatz auf Anwendungen beschränkt, bei denen es im Kontakt mit sehr aggressiven Medien steht, besonders hohe Sicherheits- oder Reinheitsanforderungen bestehen oder mögliche hohe Störfallkosten den Einsatz rechtfertigen. Dies kann beispielsweise in der chemischen, der erdölfördernden und -verarbeitenden Industrie, dem Apparate- und Kraftwerksbau, der Halbleiter-, der Lebensmittelindustrie oder in der Luft- und Raumfahrt der Fall sein.

FFKM-Teile widerstehen dem Angriff von nahezu allen Chemikalien wie z.B. Äther, Lösungsmittel, Ketone, Ester, Amine, Kraftstoffe, Säuren und Laugen.

Matériaux d'étanchéité

continue

Le FKM est remarquable pour sa tenue aux températures élevées, sa longévité, sa stabilité face à l'ozone et aux produits chimiques. Sa plage de températures va de -20°C à $+200^{\circ}\text{C}$, et $+250^{\circ}\text{C}$ pour des séquences courtes.

Le FKM est très stable pour la plupart des liquides hydrauliques sur base minérale et synthétique, constant en présence d'ozone, de l'oxygène, des carburants, des aromates, et beaucoup de solvants organiques et composés chimiques. Des restrictions interviennent pour l'utilisation de l'eau chaude, de la vapeur d'eau, et à basses températures. Du fait d'une flexibilité chimique réduite aux basses températures et d'une stabilité modérée avec la vapeur d'eau et l'eau chaude, il y aura lieu d'utiliser pour ces applications des matériaux spécifiques. Le FKM est incompatible en outre avec les dissolvants polaires tels que l'acétone, les liquides de freins sur base glycol, les gaz d'ammoniac, les alcalins et les acides organiques à molécularité faible (acide formique et acide acétique).

EPDM – Terpolymère d'éthylène-propène-diène

Les élastomères EPDM sont insensibles au vieillissement et au temps même sous l'effet de l'ozone et des U.V. Ils sont peu sensibles à la perméabilité en présence de vapeur d'eau et se fragilisent à très basse température. Pour sa grande élasticité et sa bonne stabilité vis-à-vis des corps chimiques, l'EPDM est utilisé pour la fabrication d'une grande variété de joints comme par exemple: les joints toriques O-ring et les joints plats. Sa plage de températures d'utilisation va de -40°C à $+160^{\circ}\text{C}$, et $+180^{\circ}\text{C}$ en séquences courtes.

L'EPDM a une excellente stabilité en présence d'eau chaude et de vapeur d'eau, ainsi qu'avec des liquides polaires tels que l'acétone, le méthanol, etc. Il ne convient pas pour les hydrocarbures aliphatiques et aromatiques (huiles minérales, essences, carburants) ainsi que pour les graisses.

FFKM/FFPM – Caoutchoucs fluorés

Chimiquement le FFKM est très proche du poly-tétra-fluore-éthylène (PTFE), et combine l'élasticité et les propriétés d'étanchéité d'un authentique élastomère avec la stabilité chimique du PTFE. Comparativement avec le PTFE pur les éléments en FFKM ne laissent pas de traces rampantes de fluage et peu de déformations permanentes. Les éléments élastomères perfluorés FFKM conservent leurs propriétés d'élasticité dans la durée jusqu'à $+315^{\circ}\text{C}$ et en utilisation périodique jusqu'à $+350^{\circ}\text{C}$, ceci même au contact de substances corrosives.

Etant donné son prix au kilogramme élevé, son utilisation est restreinte pour son emploi dans des milieux agressifs, et des exigences de sécurité élevées, ou des exigences de grande pureté, et où les frais d'intervention sont élevés. Ceci pourra être le cas pour les secteurs industriels de la chimie, du forage de pétrole, des industries de transformation, des constructions d'appareillages et de centrale électrique, des semi-conducteurs, de l'industrie alimentaire ou de la circulation aéronautique ou aérospatiale.

Les pièces en FFKM résistent pratiquement à toutes les attaques chimiques comme par exemple, l'éther, les dissolvants, les cétones, les esters, les amines, les carburants, les acides et les alcalins.

Sealing materials

continued

FKM features high temperature, weathering, ozone and chemical resistance. The temperature application range is from -20°C to $+200^{\circ}\text{C}$, short term $+250^{\circ}\text{C}$.

FKM is highly resistant to nearly all mineral-oil and synthetic-based hydraulic fluids, as well as to ozone, oxygen, fuels, aromatic compounds, many organic solvents and chemicals. There are however restrictions for use in hot water, steam and at low temperatures. Due to the diminished low-temperature flexibility and moderate hot water and steam resistance, special materials should be selected for these applications. FKM is also not resistant to polar solvents, such as acetone, glycol-based brake fluids, ammonia gas, alkalis and low molecular-weight organic acids (formic acid and acetic acid).

EPDM – Ethylene-Propylene-Diene-Rubber

EPDM elastomers are very resistant to ageing and weathering, even with UV exposure and ozone influence. They exhibit low water vapour permeability and extremely low brittleness temperature. Due to its high elasticity and good chemical resistance, EPDM is used for diverse seals, such as e.g. o-rings and flat gaskets. The working temperature ranges from -40°C to $+160^{\circ}\text{C}$, short term up to $+180^{\circ}\text{C}$.

EPDM possesses excellent resistance to hot water and steam and good resistance to polar liquids, such as acetone, methanol, etc. The material is not resistant to aliphatic and aromatic hydrocarbons (mineral oils, benzene, fuels) and greases.

FFKM/FFPM – Perfluoroelastomer

Chemically, FFKM is very similar to polytetrafluoroethylene (PTFE) and it combines the elasticity and sealing strength of a true elastomer with the chemical resistance of PTFE. Compared to pure PTFE seals, FFKM parts do not demonstrate creep behaviour or yield and little permanent deformation. FFKM perfluoroelastomer parts maintain their elastic properties in long-term operation at up to $+315^{\circ}\text{C}$ and in periodic operation up to $+350^{\circ}\text{C}$, even when in contact with corrosive chemicals.

Because of its comparably high kilogram price, the applications are limited to those with contact to highly aggressive media, particularly in situations where there are high safety and purity specifications or where the costs in the event of failure would be very high. Such applications are found, for example, in the chemical, petroleum producing and processing industries, equipment manufacturing, power plant construction, semiconductor and food industries or in the aerospace industry.

FFKM parts are resistant to nearly all chemicals, such as ethers, solvents, ketones, esters, amines, fuels, acids and alkalis.

Dichtungswerkstoffe

Fortsetzung

PUR – Polyurethan-Elastomere

PUR-Dichtungen werden seltener verwendet als andere Elastomer-Dichtungen. Die Einsatztemperatur liegt zwischen -30°C bis $+80^{\circ}\text{C}$. Die Vorteile von PUR gegenüber den Gummi-Elastomer-Werkstoffen sind u.a. die sehr guten mechanischen Eigenschaften, der hervorragende Verschleisswiderstand bei guter Flexibilität und die hohe Weiterreissfestigkeit in einem Härtebereich von ca. 55° bis 95° Shore A. Innerhalb dieser Shorehärte zeichnen sich PUR-Dichtungen durch eine besonders günstige Kombination von physikalischen und chemischen Eigenschaften aus.

Alle PUR-Elastomere verfügen über eine gute Quellbeständigkeit gegen mineralische Öle, Fette, Benzin und verschiedene Lösungsmittel. PUR-Elastomere sind nicht für den direkten Kontakt mit Lebensmitteln geeignet.

PTFE – Polytetrafluorethylen

PTFE ist aufgrund seiner hervorragenden chemischen, physikalischen, thermischen und elektrischen Eigenschaften ein wichtiger Werkstoff für die verschiedensten Industriezweige. Der Werkstoff ist in reiner Form physiologisch unbedenklich und FDA-konform (CFR 21, § 177.1550). Die Einsatztemperatur liegt zwischen -200°C bis $+260^{\circ}\text{C}$ (kurzzeitig bis $+300^{\circ}\text{C}$). PTFE hat einen ausgesprochen niedrigen Reibungskoeffizienten, neigt jedoch zum Kaltfluss und hat nur geringe Druck- und Verschleissfestigkeit.

PTFE ist beständig gegen nahezu alle organischen und anorganischen Chemikalien (ausser elementares Fluor unter Druck oder bei hohen Temperaturen, Fluor-Halogen-Verbindungen und Alkalimetallschmelzen). Bei Raumtemperatur ist PTFE physiologisch stabil, der Kontakt mit aggressiven Medien ändert die Werkstoffeigenschaften nicht.

VMQ – Silikon-Elastomer

VMQ zeichnet sich besonders durch den grossen thermischen Anwendungsbereich aus. Die sehr gute Kälteflexibilität, die gute Ozonbeständigkeit und die guten Dielektrischen Eigenschaften sind weitere Vorteile. Schlechter als bei anderen Elastomeren ist die Gasdurchlässigkeit. Die Einsatztemperatur liegt zwischen -60°C und $+250^{\circ}\text{C}$.

Matériaux d'étanchéité

continue

PUR – Elastomère en polyuréthane

Les joints PUR sont utilisés plus rarement que d'autres joints en élastomères ; la plage de températures d'utilisation se situe entre -30°C et $+80^{\circ}\text{C}$. Les avantages du PUR, par rapport aux élastomères caoutchoutés en d'autres matières, sont, entre autres, les très bonnes propriétés mécaniques, l'excellente résistance à l'usure, assortie d'une bonne flexibilité, ainsi que l'importante résistance au déchirement dans une fourchette de dureté de 55° à 95° Shore A. Dans cette même fourchette de dureté Shore, les joints PUR combinent avantageusement leurs propriétés physiques et chimiques.

Tous les élastomères PUR possèdent une bonne stabilité au gonflement en présence des huiles minérales, des graisses, des carburants et des différents solvants. Les élastomères PUR sont contre-indiqués pour l'alimentaire.

PTFE – Polytétrafluoréthylène

Compte tenu de ses excellentes propriétés chimiques, physiques thermiques et électriques, le PTFE est un matériau d'importance pour les secteurs industriels les plus variés. Le matériau dans sa forme physiologique pure ne présente aucun inconvénient, et, est conforme à la norme FDA (CFR21 § 177.1550). Sa plage de températures d'utilisation se situent entre -200°C et $+260^{\circ}\text{C}$ ($+300^{\circ}\text{C}$ en séquences courtes). Le PTFE dispose d'un coefficient de frottement particulièrement faible, et a une tendance pour les flux basses températures, n'ayant qu'une résistance relative à la pression et à l'usure.

Le PTFE est compatible avec pratiquement tous les composés chimiques organiques et anorganiques (à part le fluor de base sous pression ou à température élevée, des liaisons fluore - halogène, et des fondants métalliques alcalins). A température ambiante le PTFE est physiologiquement stable, le contact avec des milieux agressifs n'en modifie pas les propriétés.

VMQ – Elastomère siliconé

Le VMQ se distingue essentiellement par son utilisation dans les domaines thermiques. La très bonne flexibilité à froid, la stabilité en présence d'ozone, les bonnes propriétés diélectriques en sont d'autres avantages. La perméabilité aux gaz, par rapport à d'autres élastomères, est médiocre. La plage de températures d'utilisation se situe entre -60°C et $+250^{\circ}\text{C}$.

Sealing materials

continued

PUR – Polyurethane-Elastomer

PUR seals are used less frequently than other elastomer seals. They are used at temperatures between -30°C and $+80^{\circ}\text{C}$. The advantages of PUR compared to rubber elastomer materials are, among other, the very good mechanical properties, the excellent wear resistance with good flexibility and the high resistance to tear propagation in a hardness range of ca. 55° to 95° Shore A. Within this range of Shore hardness, PUR seals demonstrate an especially good combination of physical and chemical characteristics.

All PUR elastomers have a good swelling resistance to mineral oils, greases, benzine and diverse solvents. PUR elastomers are not suitable for direct contact with foodstuffs.

PTFE – Polytetrafluoroethylene

Due to its outstanding chemical, physical, thermal and electrical properties, PTFE is an important material in a variety of industrial sectors. The material is non-toxic in its pure form and FDA-compatible (CFR 21, § 177.1550). The working temperature is between -200°C and $+260^{\circ}\text{C}$ (short term up to $+300^{\circ}\text{C}$). PTFE has an exceptionally low coefficient of friction, tends, however, to cold flow and only has low resistance to pressure and wear.

PTFE is resistant to nearly all organic and inorganic chemicals (except elementary fluorine under pressure or at high temperatures, fluorine-halogen compounds and alkali metal fusions). At room temperature, PTFE is physiologically stable; contact with aggressive media does not alter its material properties.

VMQ – Silicone-Elastomer

VMQ is particularly characterised by its broad range of thermal application. The very good cold flexibility, the good ozone resistance and the good dielectric properties are additional advantages. The gas permeability is not as favourable as with other elastomers. The working temperature range is between -60°C and $+250^{\circ}\text{C}$.

Einleitung zur Beständigkeitstabelle

Im Sinne der Zuverlässigkeit und Langlebigkeit von SERTO Produkten erfordert der Umgang mit flüssigen oder gasförmigen Fluiden eine hohe Sorgfalt bei der Auswahl der Werkstoffe, die mit den Fluiden in Kontakt kommen. Dieses gilt insbesondere für aggressive Fluide. Die nachfolgende Tabelle zur chemischen Beständigkeit von Elastomeren, Kunststoffen und Metallen für eine Vielzahl gasförmiger und flüssiger Medien soll die Auswahl geeigneter Materialien beim Einsatz von SERTO Produkten erleichtern.

Die chemische Beständigkeit der bei SERTO verwendeten Werkstoffe ist abhängig von vielen Faktoren. Hierzu gehören u.a. die Temperatur des Mediums, der Verschmutzungsgrad des Mediums, Beimengungen unerwünschter Begleitstoffe (z.B. Wasserspuren in gasförmigem SO₂), die Konzentration des Mediums, die gleichzeitige Einwirkung mechanischer Kräfte wie statische oder dynamische Belastung sowie die Konstruktionsmerkmale des Produktes.

All diese Faktoren beeinflussen in der Praxis z.B. das Korrosionsverhalten der metallischen sowie die chemische Beständigkeit der polymeren Werkstoffe. Die in den Beständigkeitstabellen getroffenen Angaben können daher nicht alle Betriebsbedingungen und Anwendungsfälle, wie Sie im praktischen Gebrauch von SERTO Produkten auftreten, berücksichtigen.

Daher stellen die in den Beständigkeitstabellen gemachten Angaben lediglich Empfehlungen dar, für die wir jedoch keine Haftung übernehmen können. Aus den Angaben können weder Gewährleistungsansprüche noch Garantieforderungen abgeleitet werden. Die einsatzspezifische Auswahl der Werkstoffe, die Anwendung, Verwendung und Verarbeitung der bezogenen Produkte liegen ausschliesslich im Verantwortungsbereich des Kunden/Anwenders. Es empfiehlt sich im Zweifelsfall unsere Produkte – u.U. auch mit unterschiedlichen Werkstoffkombinationen – versuchsweise einzubauen, um deren Verhalten bei realen Betriebsbedingungen prüfen zu können.

Introduction tableau de compatibilité

L'esprit pour la fiabilité et la longévité des productions SERTO, requiert une attention particulière dans le choix des matériaux pour leur utilisation en présence de fluides liquides ou gazeux qui seront à leur contact, Ceci vaut en particulier pour des fluides agressifs. Le tableau ci-après, se rapportant à la compatibilité par rapport à la stabilité chimique des élastomères, des matières synthétiques, en présence de fluides liquides et gazeux, permet de choisir le composant SERTO approprié à la mise en œuvre.

La compatibilité chimique des productions SERTO est dépendante de plusieurs facteurs en matière de matériaux. Sont concernés entre autres, la température des milieux, le degré de souillures de ces derniers, l'adjonction de substances indésirables (par exemple: des éléments hydriques sous forme gazeuse de SO₂), la concentration des milieux, l'incidence mécanique par application de forces de contraintes dynamiques ou statiques, ainsi que les caractéristiques induites de fabrication.

Tous ces facteurs ont une influence en pratique comme par exemple la corrosivité des composants métalliques, ainsi que la constance des substances polymères. Ces tableaux de compatibilité chimique ne peuvent pas donner toutes les indications concernées par les applications pratiques et usuelles des composants SERTO d'une manière générale.

Pour cette raison, les tableaux de compatibilité ne donnent des recommandations qu'à titre indicatif pour lesquelles nous ne pouvons engager notre responsabilité, les données ne sont pas soumises à garanties et à ce type d'obligation, Le choix spécifique des matériaux, leur emploi, utilisation, et transformation des produits achetés, sont sous la responsabilité exclusive du seul client et utilisateur. En cas de doute il est recommandé dans certaines circonstances de combiner différents matériaux pour pouvoir en vérifier en pratique la faisabilité.

Introduction to the resistance table

For the optimal reliability and durability of SERTO products in applications with liquid or gaseous media, it is essential to exercise extreme care when selecting the materials that come into contact with the media. This is especially true for aggressive liquids. The following table on the chemical resistance of elastomers, plastics and metals to numerous gaseous and liquid media is intended to assist SERTO customers in the selection of suitable materials for their applications.

The chemical resistance of materials used by SERTO depends on many factors, such as the temperature of the medium, the degree of contamination of the medium, the admixture of unwanted impurities (e.g. traces of water in gaseous SO₂), the concentration of the medium, the simultaneous effect of mechanical forces, e.g. static or dynamic stress, as well as the design characteristics of the product.

In practice, all these factors can influence, for example, the corrosion behaviour, the metallic and chemical resistance of polymer materials. The data contained in the chemical resistance tables cannot, therefore, cover all the working conditions and applications which you will meet in your daily use of SERTO products.

For this reason, the information given in the chemical resistance tables should only be considered recommendations for which we assume no liability. No warranty claims or guarantees can be inferred from this information. The application-specific selection of materials, use, implementation and processing of purchased products lies solely within the scope of responsibility of the customer/user. If there is any doubt, we recommend installing our products - if indicated, in a variety of material combinations - in test installations to be able to determine their behaviour under real operating conditions.

Aufbau und Inhalt der Beständigkeitstabellen

Die Beständigkeitstabelle umfasst drei Bereiche chemischer Flüssigkeiten und Gase. Diese sind Grundchemikalien, Handelsprodukte sowie Lebensmittel. Im Einzelnen wurde die Beständigkeit dieser Fluide auf elastomere Werkstoffe, Kunststoffe sowie Metalle und Legierungen klassifiziert, die bei SERTO häufig Einsatz finden. Informationen zu der chemischen Beständigkeit der in den Beständigkeitstabellen nicht aufgeführten Materialien sind auf Anfrage erhältlich.

Für die gebräuchlichsten chemischen Substanzen findet sich in den Tabellen zum besseren Verständnis eine chemische Formel (Linienformel). Mit dem Zusatz „rein“ hinter der chemischen Bezeichnung des Mediums ist technische Reinheit gemeint, die in den meisten Fällen weit über 95 % Wirkstoffgehalt liegt. In der Regel tragen organische flüssige oder gasförmige Substanzen diesen Zusatz. So bedeutet z.B. „Essigsäure - rein“, dass es sich um mindestens 98 %-ige Essigsäure handelt. Der Zusatz „wässrig“ wird meistens in Verbindung von mit Wasser mischbaren Substanzen (z.B. Ethanol) oder aber für wässrige Lösungen anorganischer Salze verwendet. Wegen der Vielzahl verschiedener möglicher Konzentrationen werden generell mittlere Konzentrationen angenommen. Nur wenn es ausdrücklich vermerkt ist, handelt es sich dabei um gesättigte wässrige Lösungen. Die Bezugstemperatur für die jeweils angegebene chemische Beständigkeit ist in jedem Falle Raumtemperatur. Bei höheren Temperaturen muss bei Kunststoffen und Elastomeren mit einer wärmebedingt schlechteren Beständigkeit gerechnet werden.

Contexte et teneur du tableau de compatibilité

Le tableau de compatibilité regroupe trois domaines de la chimie des liquides et des gaz. Ce sont les produits chimiques de base, les produits du commerce, ainsi que ceux de l'alimentaire. Les compatibilités de ces fluides par rapport à une utilisation appropriée et conséquente des matières premières en élastomères par SERTO, ainsi que les matières synthétiques, les métaux et les alliages sont classifiés et répertoriés de la sorte. Les compatibilités chimiques non répertoriées dans les tableaux sont susceptibles d'être fournies sur demande. Afin de faciliter la compréhension pour l'emploi des substances chimiques, nous indiquons la formulation chimique (formules linéaires). Le rajout du terme „pure“ à la désignation chimique du milieu, désigne sa pureté technique, qui pour la plupart des cas se situe largement au-dessus de 95 % en concentration de substance active. En règle générale les substances organiques liquides ou sous forme gazeuse, contiennent cette même proportion. Ainsi par exemple pour „l'acide acétique pure“, il s'agira d'un acide ayant une teneur minimale de 98 %. L'addendum „aqueux“ est utilisé généralement en relation avec des substances miscibles à l'eau (exemple: l'éthanol), mais également pour des solutés de sels inorganiques. Etant donné la multiplicité des différentes concentrations, on retiendra généralement les concentrations moyennes. Lorsqu'il s'agira de solution aqueuse saturée, ce sera spécifié. Concernant les températures pour la compatibilité chimique, elle sera dans tous les cas la température ambiante des locaux. En présence de températures plus élevées, il y a lieu de tenir compte d'une compatibilité diminuée ou amoindrie pour les matières synthétiques et les élastomères.

Layout and content of the resistance table

The resistance table comprises three types of chemical liquids and gases: basic chemicals, trade products as well as foodstuffs. Specifically, the resistance of these fluids has been classified for the elastomer materials, plastics, metals and alloys frequently used in SERTO products. Information on the chemical resistance of materials not listed in the tables is available on request. A chemical formula for the most common substances has been included in the tables. The word „pure“ added to the chemical denomination of the medium refers to technical purity, which in most cases exceeds an active substance content of 95 %. Organic liquid or gaseous substances generally bear this term. So, for example, „acetic acid - pure“ means that this is at least a 98 % acetic acid. The word „aqueous“ is usually used in combination with substances that are miscible with water (e.g. ethanol) or for aqueous solutions of inorganic salts as well. Due to the diversity of the different concentrations possible, average concentrations are generally assumed. Only when it is explicitly mentioned does it concern a saturated aqueous solution. The reference temperature for the respective chemical resistance indicated is always room temperature. At elevated temperatures, a poorer heat-related resistance must be expected for plastics and elastomers.

Zeichenerklärung

- + geringe oder keine Beeinträchtigung des Materials, beständig
- o schwacher bis mässiger Angriff, bedingt beständig
- starker Angriff bis vollständige Zerstörung, unbeständig

Bei der Einstufung eines Materials als bedingt beständig ist vor allem die Zeit der Einwirkung zu berücksichtigen. Bei langer Einwirkungsdauer kann es häufig zu einem starken Angriff bzw. zur vollständigen Zerstörung des Materials kommen. Dieses wirkt sich dann u.U. auf die Einsatzdauer der verwendeten Teile aus. Aus diesem Grunde sind diese Teile auch als Verschleisssteile einzustufen, für die hinsichtlich des möglichen Verschleisses keine Garantie übernommen werden kann. Häufig können aufgrund unterschiedlicher Betriebsbedingungen keine eindeutigen Angaben gemacht werden. Auch in diesem Falle wird das Zeichen o verwendet für bedingt beständig.

Explications des légendes

- + détérioration faible ou inexistante du matériau, stable
- o corrosion faible à modérée, résistant sous conditions
- forte attaque chimique jusqu'à la détérioration irréversible; instable

Pour apprécier la compatibilité d'un matériau, il y a lieu avant tout de tenir compte du temps de contact. Lors d'un temps de contact prolongé, il arrive fréquemment qu'il se produit une attaque chimique importante, voire une détérioration irréversible du matériel. Cela pourra avoir pour conséquence dans certaines circonstances, une influence sur la durée de vie du matériel. Pour cette raison les matériels concernés sont à considérer comme des pièces d'usure pour lesquelles, en raison de leur détérioration, nous ne pouvons donner aucune garantie. D'une manière récurrente, compte tenu des différentes conditions d'utilisations, il n'est pas possible d'indiquer des données sans équivoques. Dans ce cas également on utilisera le symbole o, pour résistance sous conditions.

Signs and symbols

- + little or no damage to the material, resistant
- o slight to moderate attack, conditionally resistant
- strong attack to complete destruction, not resistant

If a material is classified as conditionally resistant, the amount of exposure time must be taken into account. For longer periods of exposure, the intensity of the attack is often greater, often resulting in complete destruction of the material. This can under certain circumstances have an effect on the service life of the respective part. This is why these parts are categorised as wearing parts, for which no guarantee can be given regarding the possibility of wear and tear. Explicit statements are frequently not possible due to the varying operating conditions. In such cases, the o symbol for conditionally resistant is also used.

Quellennachweis

Sämtliche Angaben der Beständigkeitstabellen stützen sich auf Erfahrungswerte der Industrie und auf Daten der Werkstoffhersteller (Quelle: www.buerkert.ch).

Justification des données

L'ensemble des données figurant sur les tableaux de correspondance provient des valeurs issues de l'expérience acquise par les applications industrielles et des données des fabricants des matériaux (source: www.buerkert.ch).

References

All the information contained in the resistance tables is based on empirical values of industry and on the data from material manufacturers (source: www.buerkert.ch).

Chemikalien- beständigkeit	Résistance chimique	Resistance to chemicals		NBR	EPDM	FKM	FFKM	PU	LD-PE	PTFE	MS	1.4401/1.4571	1.4305/1.4104	AI	PVDF	PA
Abgase - fluorwasserstoffhaltig	Gaz d'échappement - contenant du fluorure d'hydrogène	Waste gases - containing hydrogen fluoride		+	+	+	+		+	+	o	o	o	-	+	o
Abgase - kohlendioxidhaltig	Gaz d'échappement - contenant du bioxyde de carbone	Waste gases - containing carbon dioxide		+	+	+	+		+	+	+	+	o	+	+	+
Abgase - kohlenmonoxidhaltig	Gaz d'échappement - contenant du monoxyde de carbone	Waste gases - containing carbon monoxide		+	+	+	+		+	+	+	+	+	+	+	+
Abgase - nitroshaltig	Gaz d'échappement - contenant un composant nitrosé	Waste gases - containing nitrous gases		o	+	+	+		+	+	-	+	+	+	+	-
Abgase - salzsäurehaltig	Gaz d'échappement - contenant de l'acide chlorhydrique	Waste gases - containing hydrochloric acid		+	+	+	+		+	+	o	o	-	-	+	-
Abgase - schwefeldioxidhaltig (trocken)	Gaz d'échappement - contenant du bioxyde de soufre (sec)	Waste gases - containing sulphur dioxide (dry)		o	+	+	+		+	+	+	+	+	-	+	o
Abgase - schwefelsäurehaltig - (Schwefeltrioxid feucht)	Gaz d'échappement - contenant de l'acide sulfurique (trioxyde de soufre humide)	Waste gases - containing sulphuric acid - (sulphur trioxide moist)		o	+	+	+		+	+	-	+	o	-	+	-
Abgase - schwefeltrioxidhaltig (trocken)	Gaz d'échappement - contenant du trioxyde de soufre (sec)	Waste gases - containing sulphuric trioxide (dry)		o	+	+	+		+	+	o	+	+	-	+	+
Acetaldehyd - rein	Acétaldéhyde - pur	Acetaldehyde - pure	CH ₃ CHO	-	+	o	+	+	o	+	+	+	+	+	+	-
Acetessigester (säurefrei, rein)	Ester acétylacétique (sans acide, pur)	Ethyl acetoacetate (acid-free, pure)	CH ₃ COCH ₂ CO ₂ C ₂ H ₅	-	-	-	+			+	o	+	+	-	-	+
Aceton - rein	Acétone - pur	Acetone - pure	CH ₃ COCH ₃	-	+	-	+	-	o	+	+	+	+	+	+	+
Acetophenon - rein	Acétophénone - pur	Acetophenone - pure	C ₆ H ₅ COCH ₃	-	-	-	+		+	+	+	+	+	+	+	o
Acetylaceton - rein	Acétylacétone - pur	Acetyl acetone - pure	CH ₃ COCH ₂ COCH ₃	-	-	-	+		+	-	+	+	+	-	-	+
Acetylchlorid - rein	Chlorure d'acétyle - pur	Acetyl chloride - pure	CH ₃ COCl	-	-	-	+		+	+	o	o	o	-	-	-
Acetylen - rein	Acétylène - pur	Acetylene - pure	HCCH	-	+	-	+	+	+	+	+	+	+	+	+	+
Acronaldispersionen (Polyacrylsäureester für Klebstoffe)	Dispersion d'acronal (ester acide polyacrylique pour colles)	Acronal dispersion (polyacrylate for adhesives)		-	+	+					+	o	+			o
Acronallösungen	Solution d'acronal	Acronal solutions		-	o	-					+	o	+			o
Acrylnitril - rein	Acrylonitrile - pur	Acrylonitrile - pure	CH ₂ CHCN	-	-	-	+	-	o	+	+	+	+	+	+	o
Acrylsäureethylester - rein	Ester éthylique de l'acide acrylique - pur	Ethyl acrylate - pure	CH ₂ CHCOOC ₂ H ₅	-	o	-	+		-	+		+	+			o
Adipinsäure - wässrig	Acide adipique - aqueux	Adipic acid - aqueous	HO ₂ C(CH ₂) ₄ CO ₂ H	+	+	+	+		+	+		+	+	+	+	+
Akksäure (20 %-ige Schwefelsäure, wässrig)	Acide pour batteries (acide sulfurique à 20 %, aqueux)	Battery acid (20 % sulphuric acid, aqueous)	H ₂ SO ₄	o	+	+	+		+	+	-	+	o	o	+	-
Alaun (Kalium-Aluminiumsulfat) - wässrig	Alun (sulfate double de potassium et d'aluminium) - aqueux	Alum (potassium aluminium sulphate) - aqueous	KAl(SO ₄) ₂ *12H ₂ O	+	+	+	+	+	+	+	-	+	o	+	+	+
Albumin - rein	Albumine - pure	Albumin - pure		+	+	+				+	o	+	+	+	+	+
Allylalkohol - rein	Alcool allylique - pur	Allyl alcohol - pure	CH ₂ CHCH ₂ OH	+	+	-	+		-	+	+	+	+	+	+	+
Aluminiumacetat - wässrig	Acétate d'aluminium - aqueux	Aluminium acetate - aqueous	Al(OOCCH ₃) ₃	o	+	+	+		+	+	o	+	+	+	+	+
Aluminiumchlorid - wässrig	Chlorure d'aluminium - aqueux	Aluminium chloride - aqueous	AlCl ₃	+	+	+	+	o	+	+	o	o	o	-	+	o
Aluminiumfluorid - wässrig	Fluorure d'aluminium - aqueux	Aluminium fluoride - aqueous	AlF ₃	+	+	+	+		+	+	+	-	-	+	+	+
Aluminiumsulfat - wässrig	Sulfate d'aluminium - aqueux	Aluminium sulphate - aqueous	Al ₂ (SO ₄) ₃	+	+	+	+		+	+	-	o	o	+	+	o
Ameisensäure - rein	Acide formique - pur	Formic acid - pure	HCO ₂ H	-	o	-	o	-	+	+	-	+	-	+	+	-
Ameisensäure - wässrig	Acide formique - aqueux	Formic acid - aqueous	HCO ₂ H	-	o	-	-	-	+	+	-	+	o	o	+	-
Aminoessigsäure (Glykokoll)	Acide aminoacétique (glycolle)	Amino acetic acid (glycol)	NH ₂ CH ₂ COOH	o	+	+			+	+	o	+	+	+	+	o
Ammoniak (flüssig) - rein	Ammoniaque liquide - pur	Ammonia (liquid) - pure	NH ₃	-	2o	-	o	-	+	+	o	+	+	+	-	+
Ammoniak (gasförmig) - rein	Ammoniaque gazeux - pur	Ammonia (gaseous) - pure	NH ₃	-	+	-	o	-	+	+	-	+	+	+	-	+
Ammoniak-Wasser (Salmiakgeist)	Ammoniaque eau (solution ammoniacale)	Ammonium hydroxide (spirits of ammonia)	NH ₄ OH	-	+	-	o	-	+	+	-	+	+	+	+	+
Ammoniumacetat - wässrig	Acétate d'ammonium - aqueux	Ammonium acetate - aqueous	CH ₃ COONH ₄	+	+	+	+		+	+	o	+	+	+	+	+
Ammoniumcarbonat - wässrig	Carbonate d'ammonium - aqueux	Ammonium carbonate - aqueous	(NH ₄) ₂ CO ₃	+	+	+	+	-	+	+	-	+	+	+	+	+
Ammoniumchlorid - wässrig	Chlorure d'ammonium - aqueux	Ammonium chloride - aqueous	NH ₄ Cl	+	+	+	+	-	+	+	o	o	o	+	+	+
Ammoniumcitrat - wässrig	Citrate d'ammonium - aqueux	Ammonium citrate - aqueous		+	+	+	+		+	+	+	+	+	+	+	o
Ammoniumfluorsilikat - wässrig	Fluorosilicate d'ammonium - aqueux	Ammonium fluosilicate - aqueous		+	+	+	+		+	+	+	+	+	+	+	o
Ammoniumfluorid - wässrig	Fluorure d'ammonium - aqueux	Ammonium fluoride - aqueous	NH ₄ F	+	+	+	o		+	+	o	o	o	-	+	
Ammoniumformiat - wässrig	Formiate d'ammonium - aqueux	Ammonium formate - aqueous	HNCOONH ₄	+	+	+	+			+	+	+	+	+	+	+
Ammoniumnitrat - wässrig	Nitrate d'ammonium - aqueux	Ammonium nitrate - aqueous	NH ₄ NO ₃	+	+	+	+	+	+	+	-	+	+	+	+	+
Ammoniumoxalat - wässrig	Oxalate d'ammonium - aqueux	Ammonium oxalate - aqueous	NH ₄ ₂ CO ₂ NH ₄	+	+	+	+		+	+	o	+	+	+	+	o
Ammoniumpersulfat - wässrig	Persulfate d'ammonium - aqueux	Ammonium persulphate - aqueous	(NH ₄) ₂ S ₂ O ₈	-	+	+	+	+	+	+	o	o	o	-	-	-
Ammoniumphosphat - wässrig	Phosphate d'ammonium - aqueux	Ammonium phosphate - aqueous	(NH ₄) ₂ HPO ₄	+	+	+	+	+	+	+	+	+	+	+	+	+
Ammoniumthiocyanat - wässrig	Thiocyanate d'ammonium - aqueux	Ammonium thiocyanate - aqueous	NH ₄ NCS	+	+	+			+	+	o			+	+	+
Ammoniumsulfat - wässrig	Sulfate d'ammonium - aqueux	Ammonium sulphate - aqueous	(NH ₄) ₂ SO ₄	+	+	+	+	+	+	+	-	o	o	+	+	o
Ammoniumsulfid - wässrig	Sulfure d'ammonium - aqueux	Ammonium sulphide - aqueous	(NH ₄) ₂ S	+	+	o	+		+	+	-	+	+	+	+	+
Ammoniumsulfit - wässrig	Sulfite d'ammonium - aqueux	Ammonium sulphite - aqueous	(NH ₄) ₂ SO ₃	+	+	+	+		+	+	-	+	o	+	+	+
Amylacetat - rein	Acétate d'amyle - pur	Amyl acetate - pure	CH ₃ COO(CH ₂) ₄ CH ₃	-	o	-	+	-	o	+	+	+	+	+	+	+
Amylalkohol - rein	Alcool d'amyle - pur	Amyl alcohol - pure	H ₃ C(CH ₂) ₄ OH	+	o	+	+	+	+	+	+	+	+	+	+	+
Ananassaft	Jus d'ananas	Pineapple juice								+	+	-	+	+	+	+
Anilin - rein	Aniline - pure	Aniline - pure	C ₆ H ₅ NH ₂	-	+	o	o	-	o	+	-	+	+	+	+	-
Anilinhydrochlorid - wässrig	Chlorhydrate d'aniline - aqueux	Aniline hydrochloride - aqueous	C ₆ H ₅ NH ₃ Cl	o	+	3o	+		+	-	-	-	-	-	+	-

Chemikalien- beständigkeit	Résistance chimique	Resistance to chemicals		NBR	EPDM	FKM	FFKM	PU	LD-PE	PTFE	MS	1.4401/1.4571	1.4305/1.4104	AI	PVDF	PA
Anisöl	Esence d'anis	Anis seed oil		o						+	+	+	+	+		+
Anisol - rein	Anéthol - pur	Anis seed oil - pure	C ₆ H ₅ OCH ₃	o	o	-	+	-	+	+	+	+	+	+		+
Anon (Cyclohexanon) - rein	Anone (cyclohexanone) - pur	Anon (cyclohexanone) - pure	C ₆ H ₁₀ O	-	-	-	+	-	+	o	+	+	+	+		+
Anthracenöl - rein	Huile d'anthracène - pure	Anthracene oil - pure		-	-	-	+		+	+	+	+	+	+		+
Anthrachinonsulfonsäure - wässrig	Anthraquinone sulfonique acide - aqueuse	Anthraquinone sulphonic acid - aqueous	C ₆ H ₄ COCOC ₆ H ₄ SO ₃ H	o	+	+	+		+	o	o	o				o
Antifrogen-N	Antifrogen-N	Antifrogen-N		+	+	+			+	o	+	+				+
Antimonchlorid - wässrig	Chlorure d'antimoine - aqueux	Antimony chloride - aqueous	SbCl ₃	o	+	3+	+	+	+	+	-	-	-	-	+	-
Apfelsaft, Apfelmus	Jus de pomme, compote de pomme	Apple juice, Applesauce							+	+	-	+	+	+		+
Apfelsäure - wässrig	Acide malique - aqueux	Malic acid - aqueous	(HO)CH(COOH)CH ₂ COOH	+	+	+	+	o	+	-	+	+	+	+		+
Apfelsinensaft	Jus d'orange	Orange juice							+	+				+	+	
Apfelwein	Cidre	Cider		+	+	+			+	+		+	+	+		+
Aprikosensaft	Jus d'abricot	Apricot juice							+	+	+	+	+			
Arabinsäure - wässrig	Acide arabique - aqueux	Arabic acid - aqueous		+	+	+	+		+	-	+	+	+			
Argon - rein	Argon - pur	Argon - pure	Ar	+	+	+	+	+	+	+	+	+	+	+		+
Arsenige Säure - wässrig	Acide arsénieux - aqueux	Arsenious acid - aqueous	H ₃ AsO ₃ (As ₂ O ₃ +H ₂ O)	+	+	+	+	o	+	+	o	+	+	-		
Arsensäure - wässrig	Acide arsénique - aqueux	Arsenic acid - aqueous	H ₃ AsO ₄	+	+	+	+	o	+	+	-	+	+	-	+	o
Arsenichlorid - wässrig	Trichlorure d'arsenic - aqueux	Arsenic trichloride - aqueous	AsCl ₃	+	+	+	+		+	-	o	o	+			-
Arylsilikate - wässrig	Aryl silicate - aqueux	Aryl silicates - aqueous		o	o	o	+		+	+	+	+				
Ascorbinsäure - wässrig	Acide ascorbique - aqueux	Ascorbic acid - aqueous		+	+	+	+		+	+	-			+		
Asparginsäure - wässrig	Acide asparaginique - aqueux	Aspartic acid - aqueous	(HOOC)CH(NH ₂)CH ₂ COOH	+	+	+	+		+	-	+	+				+
ASTM-Kraftstoff A	Combustible A ASTM	ASTM fuel A		o	-	o	+		+	+	+	+				+
ASTM-Kraftstoff B	Combustible B ASTM	ASTM fuel B		o	-	o	+		+	+	+	+				+
ASTM-Kraftstoff C	Combustible C ASTM	ASTM fuel C		o	-	o	+		+	+	+	+				+
ASTM-Öl Nr. 1	Huile ASTM N.1	ASTM oil no. 1		+	-	+	+		+	+	+	+				+
ASTM-Öl Nr. 2	Huile ASTM N.2	ASTM oil no. 2		o	-	+	+		+	+	+	+				+
ASTM-Öl Nr. 3	Huile ASTM N.3	ASTM oil no. 3		o	-	o	+		+	+	+	+				+
ATE-Bremssflüssigkeit	Liquide pour freins ATE	ATE brake fluid		-	+	-	+		+	o	+	+	+	+		+
Ätherische Öle	Huile éthérique	Essential oils		-	-	-	+		-	+	o	+	+			-
Bariumchlorat - wässrig	Chlorate de baryum - aqueux	Cottonseed oil	Ba(ClO ₃) ₂	+	+	+	+		+	+	+	+	+	+		-
Bariumchlorid - wässrig	Chlorure de baryum - aqueux	Barium chloride - aqueous	BaCl ₂	+	+	+	+	+	+	+	+	+	+	o	+	+
Bariumhydroxid - wässrig	Hydroxide de baryum - aqueux	Barium hydroxide - aqueous	Ba(OH) ₂	+	+	+	+	+	+	+	+	+	+	+	o	+
Bariumsulfid und -polysulfid, wässrig	Sulfure et polysulfure de baryum - aqueux	Barium sulphide and polysulphide, aqueous	BaS	+	+	+	+	+	+	+	o	+	+	+	o	-
Baumwollsaamenöl	Huile de graines de coton	Cottonseed oil		o	-	o	+		+	+	+	+	+	+		+
Benzaldehyd - wässrig	Benzaldéhyde - aqueux	Benzaldehyde - aqueous	C ₆ H ₅ CHO	o	+	+	+	o	o	+	o	+		+	o	o
Benzindisulfonsäuren - wässrig	Acide benzidine sulfonique - aqueux	Benzidine sulphonic acids - aqueous	(NH ₂) ₂ C ₆ H ₄ C ₆ H ₅ (SO ₃ H)(NH ₂)	+	+	+	+		+	+	+	+				+
Benzin (Hexan) - rein	Esence (hexane) - pure	Gasoline (hexane) - pure	C ₆ H ₁₄	o	-	+	+		-	+	+	+	+	+	+	+
Benzin-Benzol-Spiritus - (Superkraftstoff-Methanol-Gemisch)	Esence-Benzol-alcool (mélange d'essence super-méthanol)	Gasoline-benzene alcohol (premium gasoline/methanol mixture)		-	-	o	+		+	o	+	+				o
Benzoessäure - wässrig	Acide benzoïque - aqueux	Benzoic acid - aqueous	C ₆ H ₅ COOH	+	+	+	+	-	+	+	o	+	+	+	+	-
Benzol - rein	Benzol - pur	Benzene - pure	C ₆ H ₆	-	-	+	+		-	o	+	+	+	+	+	o
Benzolsulfonsäure - wässrig	Acide benzènesulfonique - aqueux	Benzene sulphonic acid - aqueous	C ₆ H ₅ SO ₃ H	+	+	+	+		+	+	o	+	+	+	o	+
Benzylalkohol - rein	Alcool benzylique - pur	Benzyl alcohol - pure	C ₆ H ₅ CH ₂ OH	-	+	o	+		-	-	+	+	+	+	+	o
Benzylbutylphthalat - wässrig	Phthalate de butyle-benzyle - aqueux	Benzyl butyl phthalate - aqueous		-	-	-	+		+	+	+	+				+
Bergamotöl	Esence de bergamote	Bergamot oil		-	-	-			+	o	+	+				-
Bernsteinsäure - wässrig	Acide succinique - aqueux	Succinic acid - aqueous	HOOCCH ₂ CH ₂ COOH	+	+	+	+		+	+	+	+	+	+	+	+
Bienenwachs	Cire d'abeille	Beeswax		+	+	+			+	+	+	+	+	+		-
Bier	Bière	Beer		+	+	+			+	+	+	+	+	+	+	+
Bisulfit (Natriumbisulfit) - wässrig	Bisulfite (bisulfite de sodium) - aqueux	bisulphite (sodium hydrogen sulphite) - aqueous	NaHSO ₃	o	+	o	+		+	+	o	+	+	+	+	o
Blausäure - wässrig	Acide cyanhydrique - aqueux	Hydrocyanic acid - aqueous	HCN	o	o	+	+	+	+	+	+	+	+	o	+	-
Bleiacetat - wässrig	Acétate de plomb - aqueux	Lead acetate - aqueous	Pb(CH ₃ COO) ₂	o	+	+	+	+	+	+	o	+	+	-	+	+
Bleichlauge (Natriumhypochlorit)	Agent de blanchiment (hypochlorite de sodium)	Bleaching lye (sodium hypochlorite)		-	+	o	+		o	+	o	o	-	-	-	-
Bleinotrat - wässrig	Nitrate de plomb - aqueux	Lead nitrate - aqueous	Pb(NO ₃) ₂	+	+	+	+		+	+	-	+	+	+		
Bleitetraethyl (Tetraethylblei) - rein	Tétraéthyle de plomb (plomb Tétraéthyle) - pur	Lead tetraethyl (tetraethyl lead) - pure	Pb(CH ₂ CH ₃) ₄	o	o	+	+		+	+	o	+	+	+	+	+
Bohröle (Schneidöle)	Huiles de perceuse (huiles de coupe)	Drilling oils (cutting oils)		o	-	o	+		+	+	+	+	+	+		o
Borax - wässrig	Borax - aqueux	Borax - aqueous	Na ₂ B ₄ O ₇	+	+	+	+	+	+	+	+	+	+	+	+	+
Borfluorwasserstoffsäure (Fluorborssäure)	Acide borofluorhydrique (acide fluorborique)	Borofluoric acid (fluoboric acid)	HBF ₄	+	+	+	o	-	+	-	-	-	-	-	+	-
Borsäure - wässrig	Acide borique - aqueux	Boric acid - aqueous	H ₃ BO ₃	+	+	+	+	+	+	+	-	+	+	+	+	-
Bremssflüssigkeit (ATE-Bremssflüssigkeiten)	Liquide pour freins (liquide pour freins ATE)	Braking fluid (ATE braking fluids)		-	+	-	+		+	+	o	+	+	+	+	+
Brom (flüssig) - rein	Brome (liquide) - pur	Bromine (liquid) - pure	Br ₂	-	-	-	+		-	o	+	-	o	o	-	+

Chemikalien- beständigkeit	Résistance chimique	Resistance to chemicals		NBR	EPDM	FKM	FFKM	PU	LD-PE	PTFE	MS	1.4401/1.4571	1.4305/1.4104	AI	PVDF	PA
Bromwasserstoffsäure (wässrig)	Acide bromhydrique - aqueux	Hydrobromic acid - aqueous	HBr	-	+	+	+		o	+	-	-	-	-	+	-
Butadien (gasförmig) - rein	Butadiène (gazeux) - pur	Butadiene (gaseous) - pure	CH ₂ CHCHCH ₂	o	o	o	+	o	-	+	+	+	+	+	+	+
Butan (gasförmig und flüssig)	Butane (gazeux et liquide)	Butane (gaseous and liquid)	C ₄ H ₁₀	+	-	+	+	+	+	+	+	+	+	+	-	+
Butandiol - wässrig (10 %)	Butanediol - aqueux (10 %)	Butylene ether glycol - aqueous (10 %)	HO(CH ₂) ₄ OH	+	+	o	o			+	+	+	+	+	+	+
Butanol (Butylalkohol) - rein	Butanol (alcool butylique) - pur	Butanol (butyl alcohol) - pure	C ₄ H ₉ OH	o	+	+	+	o	o	+	+	+	+	+	+	+
Butindiol - rein	Butynediol - pur	Butyne diol - pure	HOCH ₂ C≡CCH ₂ OH	o	o	o				+	+	o	+	+	+	+
Butoxyl (Methoxybutylacetat) - rein	Butoxyle (méthoxy-butanolacétate) - pur	Butoxyl (methoxybutyl acetate) - pure	CH ₃ OC ₄ H ₈ O ₂ CCH ₃	+	o	o				+	o	+	+			
Butter	Beurre	Butter		+	+	+			+	+	-	+	+	+	+	+
Buttermilch	Babeurre	Buttermilk		+	+	+			+	+	o	+	+	+	+	-
Buttersäure - wässrig	Acide butyrique - aqueux	Butyric acid - aqueous	H ₃ CCH ₂ CH ₂ COOH	o	o	o	o	-	-	+	o	+	o	+	+	o
Butylacetat - rein	Acétate de butyle - pur	Butyl acetate - pure	CH ₃ (CH ₂) ₃ O ₂ CCH ₃	-	+	-	+	-	+	+	o	+	+	+	+	+
Butylalkohol (Butanol) - rein	Alcool butylique (butanol) - pur	Butyl alcohol (butanol) - pure	CH ₃ (CH ₂) ₃ OH	o	+	+	+	o	o	+	+	+	+	+	+	+
Butylen (flüssig) - rein	Butylène (liquide) - pur	Butylene (liquid) - pure	H ₃ CCH ₂ CHCH ₂	+	o	+	+			+	+	+	+	+	+	+
Butylphthalat - rein	Phthalate de butyle - pur	Butyl phthalate - pure	C ₆ H ₄ (CO) ₂ (OCH ₂ CH ₂ CH ₂ CH ₂) ₂	-	-	-	+			+	+	+	+	+	+	+
Calciumbisulfit - wässrig	Bisulphite de calcium - aqueux	Calcium bisulphite - aqueous	Ca(HSO ₃) ₂	+	+	+	+	o	+	+	-	+	o	o	-	
Calciumchlorid - wässrig	Chlorure de calcium - aqueux	Calcium chloride - aqueous	CaCl ₂	+	+	+	+	+	+	+	-	o	o	o	+	o
Calciumhydroxid (Kalkmilch) - wässrig	Hydroxyde de calcium (lait de chaux) - aqueux	Calcium hydroxide (lime-milk) - aqueous	Ca(OH) ₂	+	+	+	+	o	+	+	-	+	+	+	+	+
Calciumhypochlorit (Chlorkalk) - wässrig	Hypochlorite de calcium (chlorure de chaux) - aqueux	Calcium hypochlorite (chlorinated lime) - aqueous	Ca(OCl) ₂	-	+	o	+	-	+	+	-	o	o	-	+	-
Calciumnitrat - wässrig	Nitrate de calcium - aqueux	Calcium nitrate - aqueous	Ca(NO ₃) ₂	+	+	+	+	+	+	+	o	o	o	+	+	+
Carbolineum (Teeröl, Pflanzenschutzmittel)	Carbolinéum (huile de goudron; anticryptogamique)	Carbolineum (creosote; pesticide)		o	o	o	+		+	+	+	+	+	+	+	+
Carbolsäure (Phenol) - wässrig	Acide carbolique (phénol) - aqueux	Carbolic acid (phenol) - aqueous	C ₆ H ₅ OH	o	o	o	+	-	+	+	o	+	+	+	+	-
Caro'sche Säure - wässrig	Acide peroxyulfurique - aqueux	Caro's acid - aqueous	H ₂ SO ₅	-	-	-				+	-	-	-			-
Cellosolve (Glykoethylether) - rein	Cellosolve (éther éthylique du glycol) - pur	Cellosolve (glycol ethyl ether) - pure	HO(CH ₂) ₂ OCH ₂ CH ₃	-	-	-	+		-	+	+	+	+	+	+	+
Celluloselacke	Peinture cellulosique	Cellulose lacquers		-	o	-	+			+	o	+	+	+	+	+
Champheröl - rein	Huile de camphre - pure	Camphor oil - pure		+	-	+	o			+	o	+	+	+		
Chlophene (Chlordiphenyl)	Clophène (chlorure de phényle)	Chlophene (chlorobiphenyl)		+	o	+				+	+	+	+			
Chlor (flüssig) - rein	Chlore (liquide) - pur	Chlorine (liquid) - pure	Cl ₂	-	-	o	+	-	-	+	-	-	-	o	+	-
Chlor (gasförmig) - feucht (Chlorwasser)	Chlore (gazeux) - humide (eau de chlore)	Chlorine (gaseous) - wet (chlorine water)	Cl ₂	-	-	o	o	-	-	+	-	-	-	o	-	-
Chlor (gasförmig) - trocken	Chlore (gazeux) - sec	Chlorine (gaseous) - dry	Cl ₂	-	-	o	+	-	-	+	-	-	-	o	+	-
Chloralhydrat (Chloral) - wässrig	Chloral hydrate (chloral) - aqueux	Chloral hydrate (chloral) - aqueous	CCl ₃ CH(OH) ₂	-	o	o	+		-	+	o	o	o	-	-	-
Chlorbenzole - rein	Chlorobenzène - pur	Chlorobenzene - pure	C ₆ H ₅ Cl	-	-	-	+	o	-	+	+	+	+	+	+	+
Chlorbleichlaug (Natriumhypochlorit) - wässrig	Varéchine (hypochlorite de sodium) - aqueux	Sodium hypochlorite bleach - aqueous	NaOCl	-	+	o	+		o	+	o	o	o	-	o	-
Chlordioxid - wässrig	Bioxyde de chlore - aqueux	Chlorine dioxide - aqueous	ClO ₂	-	-	-	o	-		+	-	o	o	o	o	-
Chloressigsäure - wässrig	Acide chloracétique - aqueux	Chloroacetic acid - aqueous	ClCH ₂ COOH	-	o	-	+		o	+	o	o	-	-	+	-
Chlorethanol (Ethylenchlorhydrin) - rein	Chloroéthanol (chlorhydrine d'éthylène) - pur	Chloroethanol (ethylene chlorohydrine) - pure	ClCH ₂ CH ₂ OH	-	-	o	+			+	+	+	+	o	+	o
Chlorkalk (Calciumhypochlorit) - wässrig	Chlorure de chaux (hypochlorite de chaux) - aqueux	Chlorinated lime (calcium hypochlorite) - aqueous	Ca(OCl) ₂	-	+	o	+	-	+	+	-	o	o	-	+	-
Chlormethan (Methylchlorid) - rein	Chlorométhane (chlorure de méthyle) - pur	Chloromethane (methyl chloride) - pure	ClCH ₃	-	-	o	+	-	o	+	+	+	+	-	-	o
Chlornaphthalin - rein	Chloronaphtalène - pur	Chloronaphthaline - pure	C ₁₀ H ₇ Cl	-	-	o	+			+	+	+	+	+	+	+
Chloroform (Trichlormethan) - rein	Chloroforme (trichlorométhane) - pur	Chloroform (trichloromethane) - pure	CHCl ₃	-	-	o	+	-	-	+	+	+	+	+	+	-
Chlorphenole - rein	Chlorophénol - pur	Chlorophenol - pure	C ₆ H ₄ (OH)(Cl)	-	-	-	+			+	+	+	+	+	+	+
Chlorphenoxyessigsäure	Acide chloro phénoxyacétique	Chlorophenoxyacetic acid - pure	(OC ₆ H ₄) ₂ (Cl)CHCOOH	+	+	+				+	+	+	+			
Chlorsäure - wässrig (10 %)	Acide chlorique - aqueux (10 %)	Chloric acid - aqueous (10 %)	HClO ₃	-	o	-	+		+	+	-	-	-	-	+	-
Chlorsulfonsäure - rein	Acide chlorosulfonique - pur	Chlorosulphonic acid - pure	ClSO ₃ H	-	-	-	+		-	+	o	o	o	o	o	-
Chlorwasser (Chlor - feucht)	Eau de chlore (chlore - humide)	Chlorine water (chlorine - wet)	Cl ₂	-	-	o	o	-	-	+	-	-	-	-	o	-
Chlorwasserstoffgas - rein	Gaz chlore - pur	Hydrogen chloride gas - pure	HCl	o	o	+	+			+	-	+	o	-	+	-
Chlorxylenol - rein	Chloroxyène - pur	Chlorxylenol - pure	C ₆ H ₂ (OH)(CH ₃) ₂ Cl	-	-	-	+			+	+	+	+			
Cholinchlorid - wässrig	Chlorure de choline - aqueux	Choline chloride - aqueous	[HOCH ₂ CH ₂ N(CH ₃) ₃]Cl	+	+	+	+		o	-						
Chromalaun - wässrig	Alun de chrome - aqueux	Chrome alum - aqueous	KCr(SO ₄) ₂ *12H ₂ O	+	+	+	+		+	+	o	o	o	o	+	o
Chromsäure - wässrig (10 %)	Acide chromique - aqueux (10 %)	Chromic acid - aqueous (10 %)	H ₂ CrO ₄	-	o	+	+	-	+	+	-	o	o	+	+	-
Chromsulfat - wässrig	Sulfate de chrome - aqueux	Chromous sulfate - aqueous	Cr ₂ (SO ₄) ₃	+	+	+	+		+	+	o	o	o	+	o	
Citral (Citronellöl) - rein	Citral (essence de citronnelle) - pur	Citral (citronella oil) - pure		-	-	-				+	+	+	+			+
Cyankali (Kaliumcyanid) - wässrig	Cyanure de potassium (cyanure de potasse) - aqueux	Potassium cyanide - aqueous	KCN	+	+	+	+	o	+	+	-	+	+	o	+	+
Cyclanone (Fettalkoholsulfonat)	Cyclanone (sulfonate d'alcool gras)	Cyclanone (fatty alcohol sulfonate)		+	+	+				+	+	+	+	o	+	+
Cyclohexan - rein	Cyclohexane - pur	Cyclohexane - pure	C ₆ H ₁₂	-	-	o	+	+	-	+	+	+	+	+	+	+
Cyclohexanol - rein	Cyclohexanol - pur	Cyclohexanol - pure	C ₆ H ₁₁ OH	-	-	+	+	-	+	+	+	+	+	+	+	+
Cyclohexanon (Anon) - rein	Cyclohexanone (anone) - pur	Cyclohexanon (Anon) - pure	C ₆ H ₁₀ O	-	-	-	+	-	-	+	o	+	+	+	+	+

Chemikalien- beständigkeit	Résistance chimique	Resistance to chemicals		NBR	EPDM	FKM	FFKM	PU	LD-PE	PTFE	MS	1.4401/1.4571	1.4305/1.4104	AI	PVDF	PA
Cymol - rein	Cymène - pur	Cymene - pure	$C_6H_4(CH_3)[CH(CH_3)_2]$	-	-	-				+	+	+	+	+		+
Dekahydronaphthalin (Dekalin) - rein	Décahydronaphthalène (décaline) - pur	Decahydronaphthalene (decalin) - pure	$C_{10}H_{18}$	-	-	+	+	+	-	+	+	+	+	+		+
Desmodur T	Desmodur T	Desmodur T		-	-	+				+	+	+	+	+		
Desmophen	Desmophen	Desmophen		+	+	+				+		+	+			
Dextrin - wässrig	Dextrine - aqueuse	Dextrin - aqueous		+	+	+	+		+	+	+	+	+	+	+	+
Dextrose (Glukose) - wässrig	Dextrose (glucose) - aqueux	Dextrose (glucose) - aqueous	$C_6H_{12}O_6$	+	+	+	+	+	+	+	+	+	+	+	+	+
Diacetonalkohol (wasserfrei) - rein	Diacétone-alcool (anhydre) - pur	Diacetone alcohol (anhydrous) - pure	$(CH_3)_2C(OH)CH_2COCH_3$	-	+	-	+	+		+	o	+	+	+		o
Dibutylphthalat - rein	Phthalate de dibutyle - pur	Dibutyl phthalate - pure	$C_6H_4(COOC_4H_9)_2$	-	o	-	+	o		+	+	+	+	+		+
Dibutylsebacat - rein	Sébacate de dibutyle - pur	Dibutylsebacat - pure	$(C_4H_9COO)(CH_2)_8(OOC_4H_9)$	-	o	-	+	-	o	+	+	+	+	+		+
Dichlorethan (Ethylenchlorid) - rein	Dichloréthane (chlorure d'éthylène) - pur	Dichloroethane (ethyl dichloride) - pure	$ClCH_2CH_2Cl$	-	-	-	+			-	-	-	-	+	+	+
Dichlorethylen - rein	Dichloroéthylène - pur	Dichloroethylene - pure	Cl_2CHCH_3	-	-	o	+			-	+	+	+	+	o	+
Dichlormethan (Methylenchlorid) - rein	Dichlorométhane (chlorure de méthylène) - pur	Dichloromethane (methylene chloride) - pure	CH_2Cl_2	-	-	o	+			-	+	+	+	+	-	-
Dicyclohexylammoniumnitrit - rein	Nitrite de dicyclo-hexylammonium - pur	Dicyclohexyl ammonium nitrite - pure	$[(C_6H_{11})_2NH_2]NO_2$	+	+	+	+			+	o	+	+	+		+
Dieselöl - rein	Huile diesel - pure	Diesel oil - pure		o	-	+	+		o	+	+	+	+	+	+	+
Diethylether (Ether) - rein	Ether diéthylique (ether) - pur	Diethyl ether (ether) - pure	$CH_3CH_2OCH_2CH_3$	-	-	-	+			-	+	+	+	+	+	+
Dimethylamin - rein	Diméthylamine - pure	Dimethylamine - pure	$(CH_3)_2NH$	-	o	-	+		o	+	o	+	+	+	-	-
Dimethylformamid (DMF) - rein	Diméthylformamide (DMF) - pure	Dimethylformamide (DMF) - pure	$HCON(CH_3)_2$	-	-	-	+	o	+	+	o	+	+	+	-	-
Dimethylsulfoxid (DMSO) - rein	Diméthylsulfoxyde (DMSO) - pur	Dimethylsulfoxide (DMSO) - pure	$(CH_3)_2SO$	-	-	-	+	+		-	+			+	-	o
Diocetylphthalat (DOP) - rein	Phthalate de dioctyle (DOP) - pur	Diocetylphthalate (DOP) - pure	$C_6H_4(COOC_8H_{17})_2$	-	o	o	+	+		-	+	+	+	+	o	+
Dioxan - rein	Dioxane - pur	Dioxan - pure	$C_4H_8O_2$	-	o	-	+	-	o	+	+	+	+	+	-	+
Diphenyl + Diphenyloxid	Diphényle + oxyde de diphényle	Diphenyl + diphenyl oxide		-	-	-	+			+	+	+	+	+	+	+
Dissousgas (Acetylen + Aceton)	Acétylène comprimé (acétylène + acétone)	Dissolved acetylene (acetylene + acetone)		-	+	-				+	+	+	+	+	+	+
Distickstoffmonoxid (Lachgas, Stickoxydul)	Monoxyde diazote (gaz hilarant, oxyde d'azote)	Nitrogen monoxide (laughing gas, nitrous oxide)	N_2O	+	+	+	+	+		+	+	+	+	+	+	+
Edelgase	Gaz noble	Inert gases		+	+	+	+			+	o	o	+	+	+	+
Eisenchlorid - wässrig	Chlorure de fer - aqueux	Ferrous chloride - aqueous	$FeCl_3$	+	+	+	+	+	o	+	+	-	-	-	+	+
Eisensulfat - wässrig	Sulfate de fer - aqueux	Iron sulphate - aqueous	$FeSO_4$	+	+	+	+	+	+	+	o	+	+	-	+	+
Eiweisslösungen	Solutions protéiques	Protein solutions		+	+	+				+	o	+	+	+	+	+
Erdgas	Gaz naturel	Natural gas		o	-	+	+			+	o	+	+	+	+	+
Essig (Weinessig)	Vinaigre (vinaigre de vin)	Vinegar (wine vinegar)		+	+	+	+		o	+	-	+	+	+	+	-
Essigester (Ethylacetat) - rein	Ether acétique (acétate d'éthyle) - pur	Acetic ether (ethyl acetate) - pure	$CH_3CO_2CH_2CH_3$	-	o	-	o		-	+	-	+	+	+	o	o
Essigsäure - rein	Acide acétique - pur	Acetic acid - pure	CH_3COOH	-	o	-	o		-	o	+	-	+	-	+	o
Essigsäureanhydrid - rein	Anhydride acétique - pur	Acetic anhydride - pure	$CH_3COOCOCH_3$	-	o	-	o		-	+	-	o	o	+	-	-
Ethan - rein	Ethane - pur	Ethane - pure	CH_3CH_3	+	-	+	+			+	+	+	+	+	-	+
Ethanol (Ethylalkohol) - rein	Ethanol (alcool éthylique) - pur	Ethanol (ethyl alcohol) - pure	CH_3CH_2OH	o	+	o	+		+	+	+	+	+	+	+	o
Ethanolamin - rein	Ethanolamine - pure	Ethanolamine - pure	$NH_2CH_2CH_2OH$	o	o	-	+			+	-	+	+	+	o	+
Ether (Diethylether) - rein	Ether (éther diéthylique) - pur	Ether (diethyl ether) - pure	$CH_3CH_2OCH_2CH_3$	-	-	-	+			-	+	+	+	+	+	+
Ethylacetat (Essigester) - rein	Acétate d'éthyle (éther Acétique) - pur	Ethyl acetate (acetic ether) - pure	$CH_3CO_2CH_2CH_3$	-	o	-	o			-	+	-	+	+	+	o
Ethylalkohol - Gärungsmaische	Alcool éthylique - moût fermenté	Ethyl alcohol - fermentation slurry		+	+	+	+			+	+	+	+	+	+	o
Ethylalkohol - vergällt (Spiritus)	Alcool éthylique - dénaturé (alcool à brûler)	Ethyl alcohol - denatured (spirit)		o	o	o	+			+	o	+	+	+	+	o
Ethylalkohol (Ethanol) - rein	Alcool éthylique (éthanol) - pur	Ethyl alcohol (ethanol) - pure	CH_3CH_2OH	o	+	o	+		+	+	+	+	+	+	+	o
Ethylalkohol + Essigsäure	Alcool éthylique + acide acétique	Ethyl alcohol + acetic acid	$CH_3CH_2OH + CH_3COOH$	o	+	o	+			+	o	+	+	+	+	-
Ethylbenzol - rein	Ethylbenzène - pur	Ethyl benzene - pure	$C_6H_5CH_2CH_3$	-	-	o	+			-	+	+	+	+	+	+
Ethylchlorid - rein	Chlorure éthylique - pur	Ethyl chloride - pure	CH_3CH_2Cl	+	+	+	+			-	+	-	+	+	o	+
Ethylen - rein	Ethylène - pure	Ethylene - pure	$CH_2=CH_2$	+	-	+	+			+	+	+	+	+	+	+
Ethylenbromid - wasserfrei	Bromure d'éthylène - anhydre	Ethylene bromide - anhydrous	CH_2CHBr	-	-	-	+			-	+	+	+	+	o	+
Ethylenchlorhydrin (Chlorethanol) - rein	Chlorhydrine d'éthylène (chloroéthanol) - pur	Ethylene chlorohydrine (chloroethanol) - pure	$ClCH_2CH_2OH$	-	-	o	+			+	+	+	+	+	o	+
Ethylenchlorid (Dichlorethan) - rein	Chlorure d'éthylène (diChloréthane) - pur	Ethylene dichloride (dichloroethane) - pure	$ClCH_2CH_2Cl$	-	-	-	+			-	+	-	+	-	+	+
Ethylendiamin - rein	Ethylène diamine - pure	Ethylene diamine - pure	$NH_2CH_2CH_2NH_2$	o	+	o	o		o	+	-	+	o	+	+	o
Ethylenglykol (Glykol) - rein	Ethylène glycol - pur	Ethylene glycol (glycol) - pure	$HOCH_2CH_2OH$	+	+	+	+		+	+	o	+	+	+	+	o
Ethylenoxid (flüssig) - rein	Oxyde d'éthylène (liquide) - pur	Ethylene oxide (liquid) - pure	CH_2CH_2O	-	-	-	o		o	+	-	+	+	+	+	-
Ethylformiat	Formiate d'éthyle	Ethyl formate	$HCOOCH_2CH_3$	-	o	-	+			+	+	+	+	+	+	+
Färbereizmittel (Nekal BX)	Humectant pour teinture (Nexal BX)	Dyeing surfactant (Nekal BX)		+	+	+				+	o	+	+			
Ferricyankalium (Kaliumferricyanid)	Ferricyanhydrate de potassium (ferricyanure de potassium)	Potassium ferricyanide	K_3FeCN_6	+	+	+	+		+	+	-	+	+	+	+	+
Fettalkohole	Alcools gras	Fatty alcohols		+	o	+	+			+	+	+	+	o	+	+
Fettalkoholsulfate (sulfatierte Fette) - wässrig	Alcool gras sulfaté (graisses sulfatées) - aqueux	Fatty alcohol sulphates (sulphated fats) - aqueous		+	o	+	+			+	o	+	+	o	+	o
Fette, fette Öle	Graisses, huiles grasses	Fats, fatty oils		o	-	o	+		+	+	o	+	+	+	+	+

Chemikalien- beständigkeit	Résistance chimique	Resistance to chemicals		NBR	EPDM	FKM	FFKM	PU	LD-PE	PTFE	MS	1.4401/1.4571	1.4305/1.4104	AI	PVDF	PA
Fichtennadelöl	Huile d'aiguilles de sapin	Pine needle oil		o	-	+	+	-	+	o	+	+	+	+		
Firnisse	Peintures	Oil varnishes		o	-	+	+	-	+	+	+	+	+	+	+	+
Fluor (feucht) - rein	Fluor (humide) - pur	Fluorine (wet) - pure	F ₂	-	-	-	-	-	o	-	o	o	o	-	-	-
Fluor (trocken) - rein	Fluor (sec) - pur	Fluorine (dry) - pure	F ₂	-	-	o	o	-	o	o	+	+	+	-	o	-
Fluorborssäure (Borfluorwasserstoffsäure)	Acide fluoroborique (Acide borofluorhydrique)	Fluoboric acid (borofluoric acid)	HBF ₄	+	+	+	o	-	+	-	-	-	-	-	+	-
Fluorkohlenstoffe (Frigen)	Fluorocarbure (frigorigène)	Fluorocarbons (Frigen)							-	+				o	o	+
Flusssäure - wässrig	Acide fluorhydrique - aqueux	Hydrofluoric acid - aqueous	HF	-	-	-	-	+	o	-	o	o	o	-	+	-
Formaldehyd - rein	Formaldéhyde - pur	Formaldehyde - pure	CH ₂ O	+	+	+	+		+	+	+	+	+	+	+	+
Formaldehyd - wässrig	Formaldéhyde - aqueux	Formaldehyde - aqueous	CH ₂ O	o	o	o	+	+	+	-	+	+	+	+	+	+
Formamid - rein	Formamide - pur	Formamide - pure	HCONH ₂	+	+	o	o		+	+	o	+	o	+	o	o
Foto - Emulsionen, Entwickler, Fixierbäder	Emulsions développeurs, bains de fixation photographiques	Photo emulsions, developers, fixing baths		o	o	o	+		+	+				+	+	
Freon TF (Freon 113)	Fréon TF (Fréon 113)	Freon TF (Freon 113)	Cl ₃ FCFCF ₃	+	-	-	-			+	+	+	+	o	+	+
Frigen 12 B1 (Freon 12 B1)	Frigorigène 12 B1 (Fréon 12 B1)	Frigen 12 B1 (Freon 12 B1)	CBrClF ₂	+	-	o	+		-	+	+	+	+	o	+	+
Frigen 13	Frigorigène 13	Frigen 13	CClF ₃	+	-	o	o			+	+	+	+	o	-	
Frigen 13 B 1 (Halon 1301)	Frigorigène 13 B1 (Halon 1301)	Frigen 13 B 1 (Halon 1301)	CBrF ₃	+	-	o	+			+	+	+	+	o	o	+
Frigen 22	Frigorigène 22	Frigen 22	CHClF ₂	-	-	-	o		-	+	+	+	+	o	-	+
Frigen 23	Frigorigène 23	Frigen 23	CHF ₃	+	-	o	-		-	+	+	+	+	o	o	
Frigen 502	Frigorigène 502	Frigen 502	C ₆ H ₁₂ O	-	-	-	o			+	+	+	+	o	o	+
Frigenersatz HFCKW 123	Fluide frigorigène HFCKW 123	Frigen substitute HCFC 123		-	-	-	-			+	+	+	+			
Frigenersatz HFCKW 134a	Fluide frigorigène HFCKW 1234a	Frigen substitute HCFC 134a		-	-	-	-			+	+	+	+			
Frostschutzmittel KFZ	Antigel pour automobiles	Anti-freeze for automobiles		o	+	+	+		+	+	+			+	+	
Fruchtsäfte	Jus de fruit	Fruit juices		o	o	o			+	+	-	+	+	+	+	o
Gaswasser	Eau ammoniacale	Gas water		+	-	o				+	-	+	+	+		
Gelatine - wässrig	Gélatine - aqueuse	Gelatine - aqueous		+	+	+	+		+	+	o	+	+	+	+	+
Gerbsäure (Tannin)	Acide tannique (tannin)	Tannic acid (tannin)		+	+	+	+	o	+	+	o	+	+	+	+	+
Glukose (Traubenzucker) - wässrig	Glucose (sucre de raisin) - aqueux	Glucose (dextrose) - aqueous	C ₆ H ₁₂ O ₆	+	+	+	+	+	+	+	+	+	+	+	+	+
Glykokoll (Aminoessigsäure) - wässrig	Glycocolle (acide aminoéthanoïque) - aqueux	Glycine (aminoacetic acid) - aqueous	NH ₂ CH ₂ CHCO ₂ H	o	+	+			+	+	o	+	+	+	+	o
Glykol - wässrig	Glycol - aqueux	Glycol - aqueous	HOCH ₂ :CH ₂ OH	+	+	+	+		+	+	o	+	+	+	+	o
Glykolethylether (Cellosolve)	Ether éthylique du glycol (cellosolve)	Glycol ethyl ether (Cellosolve)	HO(CH ₂) ₂ OCH ₂ CH ₃	-	-	-	+		-	+	+	+	+	+	+	+
Glykolsäure - wässrig	Acide glycolique - aqueux	Gycolic acid - aqueous	HOCH ₂ :COOH	+	+	+	+			+	o	o	o	+	+	-
Glyzerin - rein	Glycéral - pur	Glycerine - pure	HOCH ₂ :CH(OH)CH ₂ :OH	o	+	+	+		+	+	o	+	o	+	+	+
Glyzerin - wässrig	Glycéral - aqueux	Glycerine - aqueous	HOCH ₂ :CH(OH)CH ₂ :OH	+	+	+	+	+	+	+	o	+	o	+	+	+
Grubengas (Methan)	Gaz de mine (méthane)	Mine gas (methane)	CH ₄	+	-	+	+	o		+	+	+	+	+	o	+
Haarschampoo	Shampooing	Hair shampoo		o	o	o				+	o	+	+	+	+	+
Harnstoff - wässrig	Urée - aqueuse	Urea - aqueous	NH ₂ CONH ₂	+	+	+	+	+	+	+	o	o	o	+	+	+
Hefe - wässrig	Levain - aqueux	Yeast - aqueous		+	+	+	+		+	+	o	+	+	+	+	+
Heizöle	Huiles combustibles	Fuel oils		o	-	+	+		-	+	+	+	+	+	+	+
Helium	Hélium	Helium	He	+	+	+	+	+	+	+	o	+	+	+	+	+
Heptane, Hexan (Benzin) - rein	Heptane, hexane (essence) - pur	Heptane, hexane (gasoline) - pure		o	-	+	+	+	-	+	+	+	+	+	+	+
Hexamethylentetramin - wässrig	Hexaméthylène tétramine - aqueux	Hexamethylene tetramine - aqueous		+	+	+	+			+	o	+	+	+	+	+
Holzteer, Holzöl (Imprägnieröle)	Goudron végétal, huiles de bois (huiles d'imprégnation)	Tar, wood oil (waterproofing oils)		-	-	-	+	+		+	+	+	+	+		
Huminsäuren	Acides humiques	Humic acids		+	+	+				+	+	+	+	+	+	-
Hydraulikfl. (Wasser in Öl, HSB)	Fluide hydraulique (eau dans l'huile, HSB)	Hydraulic fluid, water-in-oil (HSB)		o	-	+	+			+	+	+	+	+	+	+
Hydraulikfl. Mineralöle (H, H-L, H-LP)	Fluides hydrauliques, huiles minérales (H, H-L, H-LP)	Hydraulic fluid, mineral oils (H, H-L, H-LP)		o	-	o	+			+	+	+	+	+	+	+
Hydraulikfl. Phosphorsäureester (HSD)	Fluide hydraulique, ester d'acide phosphorique (HDS)	Hydraulic fluid, phosphoric ester (HSD)		-	o	o	+			+	+	+				-
Hydraulikfl. Polyglykol-Wasser (HSC)	Fluide hydraulique, polyglycol - eau (HSC)	Hydraulic fluid, polyglycol-water (HSC)		+	+	+	+			+	+	+	+	+	+	+
Hydraulikfl. Wasser-Öl-Emulsionen (HSA)	Fluides hydrauliques, émulsions eau - huile (HSA)	Hydraulic fluid, oil-in-water emulsions (HSA)		o	-	+	+			+	+	+	+	+	+	+
Hydrazinhydrat - wässrig	Hydrate d'hydrazine - aqueux	Diamide hydrate - aqueous	NH ₂ NH ₂ * ₂ H ₂ O	-	+	+	+	-	+	+	-	-	o	+	o	
Hydrochinon - wässrig	Hydroquinone - aqueuse	Hydroquinone - aqueous	C ₆ H ₄ (OH) ₂	+	+	+	+		+	+		o	+	+	+	-
Hydroxylaminsulfat - wässrig	Sulfate d'hydroxylamine - aqueux	Hydroxylamine sulphate - aqueous	(NH ₂ OH) ₂ SO ₄	+	+	+	+		+	+	-	+	+	-	+	+
Imprägnieröle (Holzteer)	Huile d'imprégnation (goudron végétal)	Waterproofing oils (tar)		-	-	-	+	+	+	+	+	+	+	+	+	+
Isobutanol - rein	Isobutanol - pur	Isobutanol - pure	(CH ₃) ₂ CHCH ₂ OH	o	+	+	+	-	+	+	+	+	+	+	+	+
Isooctan - rein	Isooctane - pur	Isooctane - pure	CH ₃ C(CH ₃) ₂ CH ₂ CH(CH ₃)CH ₃	+	-	+	+	+	o	+	+	+	+	+	+	+
Isopropanol (Propanol) - rein	Isopropanol (propanol) - pur	Isopropyl alcohol (propanol) - pure	CH ₃ CH(OH)CH ₃	o	+	+	+	o	+	+	+	+	+	+	+	o
Jod + Jodkalium - wässrig	Iode + iode de potassium - aqueux	Iodine + potassium iodide - aqueous	I ₂ + KI	o	o	o	+		+	+	-	o	o	+	+	-
Jodtinktur	Teinture d'iode	Iodine tincture		o	o	o	o		o	+	o	o	o	+	+	-

Chemikalien- beständigkeit	Résistance chimique	Resistance to chemicals		NBR	EPDM	FKM	FFKM	PU	LD-PE	PTFE	MS	1.4401/1.4571	1.4305/1.4104	Al	PVDF	PA
Kalilauge (Kaliumhydroxid) - wässrig	Potasse liquide (hydroxyde de potassium) - aqueuse	Caustic potash solution (potassium hydroxide) - aqueous	KOH	-	+	-	+	+	+	+	-	+	+	-	-	o
Kalium-Aluminiumsulfat (Alaun) - wässrig	Potasse - sulfate d'aluminium (alun) - aqueuse	Aluminium potassium sulphate (alum) - aqueous	KAl(SO ₄) ₂ * 12 H ₂ O	+	+	+	+	+	+	+	-	+	o	+	+	+
Kaliumbromat - wässrig	Bromate de potassium - aqueux	Potassium bromate - aqueous	KBrO ₃	+	+	+	+			+	-	+	o	+	+	
Kaliumbromid - wässrig	Bromure de potassium - aqueux	Potassium bromide - aqueous	KBr	+	+	+	+	+	+	+	+	o	o	+	+	-
Kaliumcarbonat (Pottasche) - wässrig	Carbonate de potassium (potasse) - aqueux	Potassium carbonate (potash) - aqueous	K ₂ CO ₃	+	+	+	+	o	+	+	+	+	+	-	-	o
Kaliumchlorat - wässrig	Chlorate de potassium - aqueux	Potassium chlorate - aqueous	KClO ₃	o	o	o	+	+		+	+	+	+	+	o	o
Kaliumchlorid - wässrig	Chlorure de potassium - aqueux	Potassium chloride - aqueous	KCl	+	+	+	+	+	+	+	+	+	+	+	+	+
Kaliumchromat - wässrig	Chromate de potassium - aqueux	Potassium chromate - aqueous	K ₂ CrO ₄	o	+	o	+		+	+	+	+	+	+	+	-
Kaliumcyanid - wässrig	Cyanure de potassium - aqueux	Potassium cyanide - aqueous	KCN	+	+	+	+	o	+	+	-	+	+	+	+	+
Kaliumdichromat - wässrig	Dichromate de potassium - aqueux	Potassium dichromate - aqueous	K ₂ Cr ₂ O ₇	o	o	o	+	+	+	+	+	+	+	+	+	+
Kaliumferrocyanid (Kaliumcyanoferrat III) - (rotes Blutlaugensalz) (Ferricyankalium), - wässrig	Ferricyanure de potassium (ferricyanhydrate de potassium III) - (prussiate rouge de potasse) (ferricyanure de potassium) - aqueux	Potassium ferrocyanide, (tripotassium hexacyanoferrate III) - red prussiate of potash - aqueous	K ₄ FeCN ₆	+	+	+	+		+	+	-	+	+	+	+	+
Kaliumferrocyanid (Kaliumcyanoferrat II) - (rotes Blutlaugensalz) (Ferricyankalium) - wässrig	Ferricyanure de potassium (ferricyanhydrate de potassium II) - (prussiate jaune de potasse) - aqueux	Potassium ferrocyanide (potassium cyanoferrate II) - yellow prussiate of potash - aqueous	K ₄ FeCN ₆	+	+	+	+		+	+	+	+	+	+	+	+
Kaliumhydrogenfluorid - wässrig	Fluorure hydrogène - Fluorure de potassium - aqueux	Potassium hydrogen fluoride - aqueous	KHF ₂	+	+	+				+	+	+	+	+	+	-
Kaliumhydroxid (Kalilauge) - wässrig	Hydroxyde de potassium (potasse liquide) - aqueux	Potassium hydroxide (caustic potash) - aqueous	KOH	-	+	-	+	+	+	+	-	+	+	-	-	o
Kaliumhypochlorit - wässrig	Hypochlorite de potassium - aqueux	Potassium hypochlorite - aqueous	KOCl	-	+	o	+	-	o	+	o	o	o	-	+	-
Kaliumjodid - wässrig	Iodure de potassium - aqueux	Potassium iodide - aqueous	KI	+	+	+	+		+	+	o	o	o	+	+	
Kaliumnitrat - wässrig	Nitrate de potassium - aqueux	Potassium nitrate - aqueous	KNO ₃	+	+	+	+	+	+	+	+	o	o	+	+	+
Kaliumnitrit - wässrig	Nitrite de potassium - aqueux	Potassium nitrite - aqueous	KNO ₂	+	+	+	+			+	+	+	+	+	+	+
Kaliumpermanganat - wässrig	Permanganate de potassium - aqueux	Potassium permanganate - aqueous	KMnO ₄	-	-	-	+		+	+	+	+	+	+	+	-
Kaliumperoxid - wässrig	Peroxyde de potassium - aqueux	Potassium peroxide - aqueous	K ₂ O ₂	-	-	-	+			+	-	+	+	-	-	
Kaliumpersulfat - wässrig	Persulfate de potassium - aqueux	Potassium persulphate - aqueous	K ₂ S ₂ O ₈	-	+	o	+		+	+	-	+	+	-	o	-
Kaliumphosphate - wässrig	Phosphate de potassium - aqueux	Potassium phosphate - aqueous		+	+	+	+			+	+	+	+	+	+	+
Kaliumsulfat - wässrig	Sulfate de potassium - aqueux	Potassium sulphate - aqueous	K ₂ SO ₄	+	+	+	+		+	+	+	+	+	+	+	+
Kaliumsulfid - wässrig	Sulfure de potassium - aqueux	Potassium sulphide - aqueous	K ₂ S	+	+	+	+		+	+	+	+	+	+	+	+
Kaliumsulfit - wässrig	Sulfite de potassium - aqueux	Potassium sulphite - aqueous	K ₂ SO ₃	+	+	+	+	+	+	+	+	+	+	+	+	+
Kerosin (Petroleumbenzin; Benzin)	Kérosène (essence de pétrole; essence)	Kerosene (petroleum benzine, gasoline)		+	-	+	+	+	-	+	+	+	+	+	+	+
Kiefernadelöl (Fichtennadelöl)	Huile d'aiguilles de pin (huile d'aiguilles de sapin)	Pine needle oil		o	-	+	+		-	+	+	+	+	+	+	
Kieselfluorwasserstoffsäure (Kieselflussssäure) - wässrig	Acide fluosilicique (acide fluosilicique) - aqueux	Hydrofluosilicic acid (silicofluoric acid) - aqueous		o	o	o	+	-	+	+	-	o	o	-	+	-
Knochenöl	Huile d'os	Bone oil		o	-	+	+			+	+	+	+	+	+	+
Kochsalz (Natriumchlorid)	Sel de cuisine (chlorure de sodium)	Salt (sodium chloride)		+	+	+	+		+	+	-	o	o	+	+	+
Kochsalz (Natriumchlorid) - wässrig	Sel de cuisine (chlorure de sodium) - aqueux	Salt (sodium chloride) - aqueous	NaCl	+	+	+	+	+	+	+	-	o	o	+	+	+
Kohlendioxid - feucht	Bioxyde de carbone - humide	Carbon dioxide - wet	CO ₂	+	+	+	+	+	+	+	+	+	+	+	+	+
Kohlendioxid - trocken	Bioxyde de carbone - sec	Carbon dioxide - dry	CO ₂	+	+	+	+	+	+	+	+	+	+	+	+	+
Kohlenmonoxid (Kohlenoxid)	Monoxyde de carbone (oxyde de carbone)	Carbon monoxide (carbon oxide)	CO	+	+	+	+	+		+	+	+	+	+	+	+
Kohlensäure - wässrig	Acide carbonique - aqueux	Carbonic acid - wet	H ₂ CO ₃	+	+	+	+	+	+	+	+	+	+	+	+	+
Kokosnussöl	Huile de noix de coco	Coconut oil		o	-	o	+		o	+	+	+	+	+	+	+
Königswasser	Eau régale	Aqua regia	HNO ₃ + HCl	-	-	-	+	-	-	+	-	-	-	-	-	-
Kresol - wässrig (s, lysol)	Crésol - aqueux (voir lysol)	Cresol - aqueous (see lysol)	C ₆ H ₄ (OH)(CH ₃)	-	-	o	+		-	+	+	+	+	+	+	-
Kupferacetat - wässrig	Acétate de cuivre - aqueux	Acetate of copper - aqueous	Cu(CH ₃ COO) ₂	o	+	+	+		+	+	+	+	+	-	+	o
Kupferchlorid - wässrig	Chlorure de cuivre - aqueux	Copper chloride - aqueous	CuCl ₂	+	+	+	+	+		+	+	+	+	-	+	o
Kupfersulfat - wässrig	Sulfate de cuivre - aqueux	Copper sulphate - aqueous	CuSO ₄	+	+	+	+	+		+	+	+	+	+	+	+
Lachgas (Distickstoffmonoxid, Stickoxydul)	Gaz hilarant (monoxyde de diazote, oxyde d'azote)	Laughing gas (nitrogen monoxide, nitrous oxide)	N ₂ O	+	+	+	+	+		+	+	+	+	+	+	+
Lebensmittelfette und -öle	Graisses et huiles alimentaires	Food greases and oils		o	-	o	+			+	+	+	+	+	+	+
Lebertran	Huile de foie	Cod liver oil		o	o	+	+		o	+	+	+	+	+	+	
Leinöl	Huile de lin	Linseed oil		o	-	o	+		o	+	+	+	+	+	+	+
Leuchtgas (Stadtgas, Ferngas)	Gaz d'éclairage (gaz de ville, gaz étranger)	Coal gas (town gas, grid gas)		+	+	+	+	+	o	+	+	+	+	+	+	+
Linolsäure	Acide linoléique	Linoleic acid		o	-	o	+			+	+	+	+	+	+	+
Lithiumchlorid - wässrig	Chlorure de lithium - aqueux	Lithium chloride - aqueous	LiCl	+	+	+	+			+	+	+	+	+	+	+
Lysol (siehe auch Kresole)	lysol (cf. crésol)	lysol (see also cresol)		-	-	o	+		-	+	+	+	+	+	+	-
Magnesiumchlorid - wässrig	Chlorure de magnésium - aqueux	Magnesium chloride - aqueous	MgCl ₂	+	+	+	+	+	+	+	+	+	+	+	+	+
Magnesiumsulfat - wässrig	Sulfate de magnésium - aqueux	Magnesium sulphate - aqueous	MgSO ₄	+	+	+	+	+	+	+	+	+	+	+	+	+
Maiskeimöl	Huile de germes de maïs	Corn oil		o	-	o	+			+	+	+	+	+	+	+
Maleinsäure - wässrig	Acide malique - aqueux	Maleic acid - aqueous		+	+	+	+	-	+	+	+	+	+	+	+	+
Manganchlorid - wässrig	Chlorure de manganèse - aqueux	Manganese chloride - aqueous	MnCl ₂	+	+	+	+			+	+	+	+	+	+	+

Chemikalien- beständigkeit	Résistance chimique	Resistance to chemicals		NBR	EPDM	FKM	FFKM	PU	LD-PE	PTFE	MS	1.4401/1.4571	1.4305/1.4104	AI	PVDF	PA
Mangansulfat - wässrig	Sulfate de manganèse - aqueux	Manganese sulphate - aqueous	MnSO ₄	+	+	+	+			+	o	+	o	+	+	+
Maschinenöl siehe a) Paraffinöl b) Mineralöl; Motorenöl	Huiles pour machines cf. a) huiles de paraffine b) huiles minérales; huiles pour moteurs	Machine oil, see a) paraffin oils b) mineral oils; motor oils		+	-	+	+		o	+	+	+	+	+	+	+
Melasse, Melassewürze	Mélasse, condiment de mélasse	Molasses, molasses extract		+	+	+	+		+	+	o	+	+	+	+	+
Mercaptane	Mercaptan	Mercaptans		-	-	o	+			+	o	+	+		o	+
Mersole (Alkansulfonsäurechloride)	Mersole (chlorure d'acide alcane sulfonique)	Mersol (alkane sulfochloride)		+	o	+				+	o	o	o		-	
Methan (Sumpfgas) - rein	Méthane (sol alluvial) - pur	Methane (marsh gas) - pure	CH ₄	+	-	+	+	o		+	+	+	+	+	+	o
Methanol (Methylalkohol)	Méthanol (alcool méthylique)	Methanol (methyl alcohol)	CH ₃ OH	-	+	-	+	o	+	+	+	+	+	+	+	o
Methoxybutanol - rein	Méthoxybutanol - pur	Methoxybutanol - pure	CH ₃ O(CH ₂) ₃ CH ₂ OH	+	+	+	+		o	+	+	+	+	+	+	o
Methylacetat - rein	Méthylacétate - pur	Methyl acetate - pure	CH ₃ COOCH ₃	-	o	-	+		+	+	o	o	o	+	+	o
Methylalkohol (Methanol) - rein	Alcool méthylique (méthanol) - pur	Methyl alcohol (methanol) - pure	CH ₃ OH	-	+	-	+	o	+	+	+	+	+	+	+	o
Methylamin - wässrig	Méthylamine - aqueux	Methylamine - aqueous	CH ₃ NH ₂	-	o	o	-		o	+	-	o	o	+	-	o
Methylchlorid (Chlormethan) - rein	Chlorure de méthyle (chlorométhane) - pur	Methyl chloride (chloromethane) - pure	CH ₃ Cl	-	-	+	+	-	o	+	+	+	+	+	-	o
Methylenchlorid (Dichlormethan) - rein	Chlorure de méthylène (dichlorométhane) - pur	Methylene chloride (dichloromethane) - pure	CH ₂ Cl ₂	-	-	o	+	-	-	+	+	+	+	-	-	-
Methylethylketon - rein	Méthyléthylcétone - pur	Methyl ethyl ketone - pure	CH ₃ COCH ₂ CH ₃	-	o	-	+		-	+	+	+	+	+	-	o
Milch	Lait	Milk		+	+	+			+	+	o	+	+	+	+	+
Milchsäure - wässrig	Acide lactique - aqueux	Lactic acid - aqueous		o	o	+	+	+	+	+	o	o	o	+	+	o
Mineralöl-aromatenfrei (Paraffinöl, Motorenöl)	Huiles minérales - sans aromates (huile de paraffine, huiles pour moteurs)	Mineral oils - free of aromatic compounds (paraffin oils, motor oils)		+	-	+	+		o	+	+	+	+	+	+	+
Mineralwasser	Eau minérale	Mineral water		+	+	+			+	+	o	o	o	+	+	+
Morpholin - rein	Morpholine - pure	Morpholine - pure		-	o	o	o		+	+	+	+	+	+	+	+
Motorenöl (Mineralöl; Maschinenöl)	Huiles pour moteurs (huiles minérales, huiles pour machines)	Motor oils (mineral oils, machine oils)		+	-	+	+		o	+	+	+	+	+	+	+
Natriumarsenat und Natriumarsenit - rein	Arsénate et arsénite de sodium - purs	Sodium arsenate and sodium arsenite - pure	Na ₃ AsO ₄ u. Na ₃ AsO ₃	+	+	+	+			+	+	+	+	+	+	+
Natriumbenzoat - wässrig	Benzoate de sodium - aqueux	Sodium benzoate - aqueous	C ₆ H ₅ COONa	+	+	+	+		+	+	+	+	+	+	+	+
Natriumbicarbonat - wässrig	Bicarbonate de sodium - aqueux	Sodium bicarbonate - aqueous	NaHCO ₃	+	+	+	+	+	+	+	o	+	+	+	+	+
Natriumbisulfat - wässrig	Bisulfate de sodium - aqueux	Sodium bisulphate - aqueous	NaHSO ₄	+	+	+	+	-	+	+	o	o	o	+	+	+
Natriumbisulfit - wässrig (Bisulfit)	Bisulfite de sodium - aqueux (bisulfite)	Sodium bisulphite - aqueous (bisulphite)	NaHSO ₃	o	+	+	+		+	+	o	+	o	+	+	+
Natriumbromat - wässrig	Bromate de sodium - aqueux	Sodium bromate - aqueous	NaBrO ₃	+	+	+	+		o	+	-	+	o	+	+	o
Natriumbromid - wässrig	Bromure de sodium - aqueux	Sodium bromide - aqueous	NaBr	+	+	+	+		+	+	o	o	o	-	+	-
Natriumcarbonat (Soda) - wässrig	Carbonate de sodium (soude) - aqueux	Sodium carbonate (soda) - aqueous	Na ₂ CO ₃	+	+	+	+		+	+	o	+	+	o	+	+
Natriumchloracetat	Chloroacétate de sodium	Sodium chloroacetate		+	+	+	+			+	o	+	+	+	+	+
Natriumchlorat - wässrig	Chlorate de sodium - aqueux	Sodium chlorate - aqueous	NaClO ₃	o	o	o	+	+	+	+	o	o	o	+	+	o
Natriumchlorid (Kochsalz) - wässrig	Chlorure de sodium (sel de cuisine) - aqueux	Sodium chloride (salt) - aqueous	NaCl	+	+	+	+	+	+	+	-	o	o	+	+	+
Natriumchlorit - wässrig	Chlorite de sodium - aqueux	Sodium chlorite - aqueous	NaClO ₂	-	o	o	+		o	+	o	o	-	+	+	-
Natriumchromat - wässrig	Chromate de sodium - aqueux	Sodium chromate - aqueous	NaCrO ₄	o	+	o	+		+	+	+	o	o	+	+	-
Natriumcyanid - wässrig	Cyanure de sodium - aqueux	Sodium cyanide - aqueous	NaCN	+	+	+	+	o	+	+	-	+	+	-	+	+
Natriumdodecylbenzolsulfonat - wässrig	Lauryl-benzène sulfonate de sodium - aqueux	Sodium dodecylbenzenesulfonate - aqueous		+	+	+			+	+	o	+	+	+	+	+
Natriumfluorid - wässrig	Fluorure de sodium - aqueux	Sodium fluoride - aqueous	NaF	+	+	+	+	+	+	+	+	+	+	+	+	+
Natriumglutamat - wässrig	Glutamate de sodium - aqueux	Monosodium glutamate - aqueous		+	+	+	+			+	+	+	+	+	+	+
Natriumhydrogencarbonat - wässrig	Carbonate d'hydrogène - sodium - aqueux	Sodium bicarbonate - aqueous	NaHCO ₃	+	+	+	+		+	+	o	+	+	+	+	+
Natriumhydroxid - wässrig	Hydroxyde de sodium - aqueux	Sodium hydroxide - aqueous	NaOH	-	+	-	+	+	+	+	-	+	+	-	-	+
Natriumhypochlorit (Chlorbleichlaugung) - wässrig	Hypochlorite de sodium (varéchine) - aqueux	Sodium hypochlorite bleach - aqueous	NaOCl	-	+	o	+		o	+	o	o	o	-	o	-
Natriumjodid - wässrig	Iodure de sodium - aqueux	Sodium iodide - aqueous	NaI	+	+	+	+		+	+	o	o	o	+	+	+
Natriummercaptopbenzothiazol - rein	Sel sodique de mercaptobenzothiazole - pur	Sodium mercaptobenzothiazole - pure		o	o	+	+		+	+	+	+	+			
Natriumnitrat - wässrig	Nitrate de sodium - aqueux	Sodium nitrate - aqueous	NaNO ₃	+	+	+	+	+	+	+	-	+	-	+	+	+
Natriumnitrit - wässrig	Nitrite de sodium - aqueux	Sodium nitrite - aqueous	NaNO ₂	+	+	+	+	+	+	+	+	+	+	+	+	+
Natriumpentachlorphenolat - rein	Pentachlorophénate de sodium - pur	Sodium pentachlorophenolate - pure	C ₆ Cl ₅ ONa	+	+	+				+	+	+	+			+
Natriumperborat - wässrig	Perborate de sodium - aqueux	Sodium perborate - aqueous	NaBO ₃	o	+	+	+		+	+	o	+	+	+	+	+
Natriumpersulfat - wässrig	Persulfate de sodium - aqueux	Sodium persulphate - aqueous	K ₂ S ₂ O ₈	o	+	+	+			+	-	+	o	-	+	-
Natriumphosphat - wässrig	Phosphate de sodium - aqueux	Sodium phosphate - aqueous	Na ₃ PO ₄	+	+	+	+	+	+	+	o	o	o	+	+	+
Natriumpropionat - wässrig	Propionate de sodium - aqueux	Sodium propionate - aqueous	CH ₃ CH ₂ COONa	+	+	+				+	+	+	+	+	+	+
Natriumpyrosulfit - wässrig	Pyrosulfite de sodium - aqueux	Sodium metabisulphite - aqueous	Na ₂ S ₂ O ₅	o	+	+		+	+	+	o	+	o	+		+
Natriumsilikat - wässrig	Silicate de sodium - aqueux	Sodium silicate - aqueous		+	+	+	+		+	+	o	+	+	+	+	+
Natriumstannat - wässrig	Stannate de sodium - aqueux	Sodium stannate - aqueous	Na ₂ SnO ₃	+	+	+	+			+	o	+	+	+		o
Natriumsulfat - wässrig	Sulfate de sodium - aqueux	Sodium sulphate - aqueous	Na ₂ SO ₄	+	+	+	+		+	+	-	+	+	+	+	+
Natriumsulfid - wässrig	Sulfure de sodium - aqueux	Sodium sulphide - aqueous	Na ₂ S	+	+	+	+		+	+	o	+	+	o	o	+
Natriumsulfit - wässrig	Sulfite de sodium - aqueux	Sodium sulphite - aqueous	Na ₂ SO ₃	+	+	+	+		+	+	o	+	o	+	+	+
Natriumtartrat - wässrig	Tartrate de sodium - aqueux	Sodium tartrate - aqueous		+	+	+	+			+	+	+	+			+

Chemikalien- beständigkeit	Résistance chimique	Resistance to chemicals		NBR	EPDM	FKM	FFKM	PU	LD-PE	PTFE	MS	1.4401/1.4571	1.4305/1.4104	AI	PVDF	PA
Natriumthiosulfat - wässrig	Thiosulfate de sodium - aqueux	Sodium thiosulphate - aqueous	Na ₂ S ₂ O ₃	+	+	+	+		+	+	o	o	o	+	+	+
Natriumzinkat - wässrig	Zincate de sodium - aqueux	Sodium zincate - aqueous	Na ₂ [Zn(OH) ₄]	o	+	+				+		+	+	-		
Natronlauge (Natriumhydroxid) - wässrig	Soude caustique (hydroxyde de sodium) - aqueuse	Soda lye (sodium hydroxide) - aqueous	NaOH	o	+	o	+	+	+	+	o	+	+	-	-	o
Nekal BX - wässrig (Färbereinetzmittel)	Nekal BX - aqueux (humectant pour teinture)	Nekal BX - aqueous (dyeing surfactant)		+	+	+	o			+	o	+	+			
Nickelbäder	Bains de nickel	Nickel baths		+	+	+				+	-	+	o			+
Nickelsulfat - wässrig	Sulfate de nickel - aqueux	Nickel sulphate - aqueous	Ni(SO ₄) ₂	+	+	+	+	+	+	+	-	o	-	o	-	+
Nitrobenzoesäuren - wässrig	Acide de nitrobenzène - aqueux	Nitrobenzoic acids - aqueous		+	+	+	+		o	+	+	+	+	+	+	+
Nitrobenzol - rein	Nitrobenzène - pur	Nitrobenzene - pure	C ₆ H ₅ NO ₂	-	-	o	+	-	-	+	+	+	+	+	+	o
Nitrose Gase - feucht und trocken	Gaz nitreux - humide et sec	Nitrous fumes - wet and dry	[NO, NO ₂ , N ₂ O ₄]	-	o	-	o			+	-	+	+	+	+	o
Nitrotoluole (o-, m-, p) - rein	Nitrotoluène (o-, m-, p) - pur	Nitrotoluene (o-, m-, p) - pure	C ₆ H ₄ (NO ₂)(CH ₃)	o	-	o	o		o	+	+	+	+	+	+	+
Obstbaum-Karbolinum (Karbolinum)	Carbolinum pour arbres fruitiers (carbolinum)	Fruit tree carbolinum (carbolinum)		o	o	o	+		+	+	+	+	+	+	+	+
Oleum (rauchende Schwefelsäure)	Oléum (acide sulfurique fumant)	Pyrosulfuric acid (fuming sulfuric acid) I	H ₂ SO ₄	-	-	o	+	-	-	+	-	+	+	+	+	-
Olivenöl	Huile d'olive	Olive oil		o	-	o	+			+	o	+	+	+	+	+
Oxalsäure - wässrig	Acide oxalique - aqueux	Oxalic acid - aqueous	HOOC-COOH	o	+	+	+	-	+	+	-	+	+	+	+	-
4Ozon - feucht und trocken	4Ozone - humide et sec	4Ozone - wet and dry	O ₃	-	o	o	o	+	-	+	+	+	+	+	+	-
Paraffinöl (Mineralöle)	Huile de paraffine (huiles minérales)	Paraffin oil (mineral oils)		+	-	+	+		+	+	+	+	+	+	+	+
Perchloräthylen (Tetrachlorethylen) - rein	Perchloréthylène (tétrachloréthylène) - pur	Perchloroethylene (tetrachloroethylene) - pure	Cl ₂ CCl ₂	-	-	o	o	-	-	+	o	+	+	+	+	o
Peressigsäure - wässrig (6 %)	Acide péraécétique - aqueux (6 %)	Peracetic acid - aqueous (6 %)	CH ₃ CO ₂ H	-	+	+	+			+	-	+	+			-
Petroleum - rein	Kérosène - pur	Petroleum - pure		+	-	+	+		o	+	+	+	+	+	+	+
Petroleumbenzin, Petroether	Essence de pétrole, éther de pétrole	Petroleum benzine, petroleum ether		+	-	+	+		-	+	+	+	+	+	+	+
Pflanzenschutzmittel (Karbolinum)	Anticryptogamique (carbolinum)	Pesticide (carbolinum)		o	o	o	+			+	+	+	+	+	+	+
Phenol - wässrig	Phénol - aqueux	Phenol - aqueous	C ₆ H ₅ OH	o	o	o	+	-	+	+	o	+	+	+	+	o
Phosgen (flüssig) - rein	Phosgène (liquide) - pur	Phosgene (liquid) - pure	COCl ₂	-	o	+				+	+	+	+	+	+	o
Phosgen (gasförmig) - rein	Phosgène (gazeux) - pur	Phosgene (gaseous) - pure	COCl ₂	-	+	+			-	+	+	+	+	+	+	o
Phosphorchloride - rein	Chlorure de phosphore - pur	Phosphorous chloride - pure		-	-	o	+		-	+		o	o	+	+	-
Phosphorsäure - wässrig	Acide phosphorique - aqueux	Phosphoric acid - aqueous	H ₃ PO ₄	o	o	+	+	+	+	+	-	+	-	-	+	-
Pikrinsäure (Trinitrophenol) - rein	Acide picrique (trinitrophénol) - pur	Picric acid (trinitrophenol) - pure	C ₆ H ₂ (OH)(NO ₂) ₃	o	-	o	+	-	o	+	+	+	+	+	+	+
Pinen (Terpentinöl) - rein	Pinène (huile de térébenthine) - pur	Pinene (terpentine oil) - pure		o	-	o	+		-	+	o	+	+	+	+	+
Pottasche (Kaliumcarbonat) - wässrig	Potasse (carbonate de potassium) - aqueuse	Potash (potassium carbonate) - aqueous	K ₂ CO ₃	+	+	+	+	o	+	+	o	+	+	-	-	o
Propan (flüssig und gasförmig) - rein	Propane (liquide et gazeux) - pur	Propane (liquid and gaseous) - pure	C ₃ H ₈	+	-	+	+	+	-	+	+	+	+	+	+	+
Propanol (Isopropanol) - rein	Propanol (isopropanol) - pur	Propyl alcohol (isopropyl alcohol) - pure	CH ₃ CH(OH)CH ₃	-	+	+	+	o	+	+	+	+	+	+	+	o
Propylenglykol - rein	Propylène glycol - pur	Propylene glycol - pure	HOCH ₂ CH ₂ CH ₂ OH	+	+	+	+		+	+	+	+	+	+	+	o
Pydraul-A 150	Pydraul-A 150	Pydraul-A 150		-	o	+				+	-	+				+
Pydraul-A 200	Pydraul-A 200	Pydraul-A 200		-	o	+				+	-	+				+
Pydraul-AG	Pydraul-AG	Pydraul-AG		-	+	+				+	-	+				+
Pydraul-F-9	Pydraul-F-9	Pydraul-F-9		-	+	+				+	-	+				-
Pyridin - rein	Pyridine - pure	Pyridine - pure	C ₅ H ₅ N	-	-	-	+	-	o	+	+	+	+	+	+	+
Quecksilber	Mercur	Mercury	Hg	+	+	+	+	+	+	+	-	o	+	+	+	+
Quecksilberchlorid - wässrig	Chlorure de mercure - aqueux	Mercurous chloride - aqueous	HgCl ₂	+	+	+	+	+	+	+	-	o	o	-	+	-
Quecksilbersalze - wässrig	Sels de mercure - aqueux	Mercury salts - aqueous		+	+	+	+	+		+	-	+	+	-	+	-
Rapsöl	Huile de colza	Rapeseed oil		o	-	o	+			+	o	+	+	+	+	+
Rizinusöl	Huile de ricin	Castor oil		o	-	o	+		+	+	o	+	+	+	+	+
Saccharin (Süsstoff)	Saccharine (édulcorant)	Saccharin (sweetener)		+	+	+				+	+	+	+			
Salmiakgeist (Ammoniak - Wasser)	Solution ammoniacque (ammoniaque - eau)	Ammonia solution (liquid ammonia)	NH ₄ OH	-	+	-	+	-	+	+	-	+	+	+	+	+
Salpetersäure - wässrig (40 %)	Acide nitrique - aqueux (40 %)	Nitric acid - aqueous (40 %)	HNO ₃	-	-	3+	+	-	-	+	-	+	-	-	+	-
Salzsäure - wässrig (36 %)	Acide chlorhydrique - aqueux (36 %)	Hydrochloric acid - aqueous (36 %)	HCl	-	o	3+	+	+	+	+	-	+	o	-	+	-
Sauerstoff	Oxygène	Oxygen	O ₂	o	o	5+	+		o	+	+	+	+	+	+	+
Schmieröle (vorwiegend Mineralöle)	Huiles lubrifiantes (huiles minérales principales)	Lubricating oils (mainly mineral oils)		+	-	+	+		-	+	+	+	+	+	+	+
Schwefelchlorid (oxydchlorid) - rein	Chlorure de soufre - pur	Sulphur chloride (oxychloride) - pure		-	-	+	+			+	o	+	-	o	+	-
Schwefeldioxid (flüssig) - rein	Bioxyde de soufre (liquide) - pur	Sulphur dioxide (liquid) - pure	SO ₂	-	+	+	+	-	-	+	+	+	+	+	+	-
Schwefeldioxid (Gas, feucht)	Bioxyde de soufre (gazeux, humide)	Sulphur dioxide (gas, wet)	SO ₂	-	+	+	+		-	+	-	+	o	o	+	o
Schwefeldioxid (Gas, trocken) - rein	Bioxyde de soufre (gazeux, sec) - pur	Sulphur dioxide (gas, dry) - pure	SO ₂	-	+	+	+		-	+	o	+	o	o	+	o
Schwefelhexafluorid - rein	Hexafluorure de soufre - pur	Sulphur hexafluoride - pure	SF ₆	+	+	o	o			+	+	+	+	+	+	+
Schwefelige Säure - wässrig	Acide sulfureux - aqueux	Sulphurous acid - aqueous	H ₂ SO ₃	-	+	+	+	o	+	+	-	+	-	o	+	-
Schwefelkohlenstoff - rein	Sulfure de carbone - pur	Carbon bisulphide - pure	CS ₂	-	-	+	+	+	-	+	-	+	-	+	+	o
Schwefelsäure - konzentriert (96 %)	Acide sulfurique - concentré (96 %)	Sulphuric acid - concentrated (96 %)	H ₂ SO ₄	-	-	o	+	-	-	+	-	-	-	-	+	-
Schwefelsäure - wässrig (30 %)	Acide sulfurique - aqueux (30 %)	Sulphuric acid - aqueous (30 %)	H ₂ SO ₄	o	+	+	+	o	+	+	-	-	-	o	+	-
Schwefelwasserstoff - wässrig	Acide sulfhydrique - aqueux	Hydrogen sulphide - aqueous	H ₂ S	o	+	-	-		+	+	o	+	+	+	+	-

Chemikalien- beständigkeit	Résistance chimique	Resistance to chemicals		NBR	EPDM	FKM	FFKM	PU	LD-PE	PTFE	MS	1.4401/1.4571	1.4305/1.4104	AI	PVDF	PA
Seifenlösung - wässrig	Solution savonneuse - aqueuse	Soap solution - aqueous		o	o	o	+			+	o	+	+	o	+	o
Silbernitrat - wässrig	Nitrate d'argent - aqueux	Silver nitrate - aqueous	AgNO ₃	o	+	+	+			+	-	+	+	-	+	+
Silikonöl	Huile de silicone	Silicone oil		+	+	+	+	+	+	+	+	+	+	+	+	+
Skydrol 500	Skydrol 500	Skydrol 500		-	+	o	+			+	-	+	+			o
Skydrol 7000	Skydrol 7000	Skydrol 7000		-	+	-	+			+	-	+	+			o
Soda (Natriumcarbonat)	Soude (carbonate de sodium)	Soda (sodium carbonate)		+	+	+	+		+	+	o	+	+	o	o	+
Sojaöl	Huile de soja	Sojbean oil		o	-	o	+			+	o	+	+	+	+	+
Sole (Kühlsolen)	Saumure (mélanges frigorifiques)	Brine (cooling brine)		+	+	+	+			+	o	o	o			+
Speiseöl	Huile comestible	Edible oil		o	-	o	+		+	+	o	+	+	+	+	+
Spindelöl (Mineralöle)	Huile à broches (huiles minérales)	Spindle oil (mineral oil)		+	-	+	+			+	+	+	+	+	+	+
Spiritosen - (abhängig von Inhalts- und Aromastoffen)	Boissons alcoolisées (selon les composants et les aromatisants)	Spirits - (depends on ingredients and flavours)		o	o	o			+	+	-	+	+	+	+	+
Stärke­lösung - wässrig	Solution d'amidon - aqueuse	Starch solution - aqueous		+	+	+	+	+	+	+	o	+	+	+	+	+
Stearinsäure	Acide stéarique	Stearic acid	C ₁₈ H ₃₇ COOH	+	+	+	+	+	o	+	+	+	+	+	+	+
Stickoxide (Nitrose Gase)	Oxyde azotique (oxyde nitrique)	Nitrogen oxide (nitrous fumes)		-	-	-	o			+	-	o	-	o	-	-
Stickoxydul (Distickstoffmonoyd)	Oxyde d'azote (monoxyde de diazote)	Nitrous oxide (dinitrogen oxide)	N ₂ O	+	+	+	+	+		+	+	+	+	+	+	+
Stickstoff	Azote	Nitrogen	N ₂	+	+	+	+	+		+	+	+	+	+	+	+
Styrol - rein	Styrol - pur	Styrene - pure	C ₆ H ₅ CHCH ₂	-	-	o	+	o	-	+	o	+	+	+	+	+
Sumpfgas (Methan)	Méthane (sol alluvial) (méthane)	Marsh gas (methane)	CH ₄	+	-	+	+	o		+	+	+	+	+	+	+
Tallöl	Tallol	Tall oil		o	o	o				+	-	+	o	+	+	+
Tannin (Gerbsäure)	Tannin (acide tannique)	Tannin (tannic acid)		+	+	+	+	o	+	+	o	+	+	+	+	+
Teeröl (Karbolineum)	Huile de goudron (carbolinéum)	Creosote (carbolineum)		o	o	o	+		+	+	+	+	+	+	+	+
Terpentin (Terpentinöl) - rein	Térébenthine (huile de térébenthine) - pure	Terpentine (terpentine oil) - pure		o	-	o	+		-	+	o	+	+	+	+	+
Terpentinersatz (Testbenzin)	Tubstitut de térébenthine (essence solvante)	Terpentine substitute (solvent naphtha)		o	-	o	+		o	+	+	+	+	+	+	+
Testbenzin - rein (Shellsol D)	Essence solvante - pure (Shellsol D)	Solvent naphtha - pure (Shellsol D)		o	-	o	+		o	+	+	+	+	+	+	+
Tetrachlorethylen (Perchloroethylen)	Tétrachloroéthylène (perchloroéthylène)	Tetrachloroethylene (perchloroethylene)	Cl ₂ CCl ₂	-	-	o	o	-	-	+	o	+	+	+	+	+
Tetrachlorkohlenstoff - rein	Tétrachlorure de carbone - pur	Carbon tetrachloride - pure	CCl ₄	-	-	+	+		-	+	o	+	+	+	+	+
Tetraethylblei (Blei­tetraethyl)	Tétraéthyle de plomb (plomb tétraéthyle)	Tetraethyl lead (lead tetraethyl)	Pb (CH ₂ CH ₃) ₄	o	o	+	+		+	+	o	+	+	+	+	+
Tetrahydrofuran - rein	Tétrahydrofurane - pur	Tetrahydrofurane - pure	C ₄ H ₈ O	+	-	-	+		-	+		+	+	+	-	+
Tetrahydronaphthalin (Tetralin) - rein	Tétrahydronaphthalène (tétraline) - pur	Tetrahydronaphthalene (Tetralin) - pure	C ₁₀ H ₁₂	-	-	+	+		-	+	+	+	+	+	+	+
Thiophen - rein	Thiofène - pur	Thiophene - pure	C ₄ H ₄ S	-	-	-	+		-	+	o	+	+	+		
Toluol - rein	Toluol - pur	Toluol - pure	C ₆ H ₅ CH ₃	-	-	o	+	-	-	+	+	+	+	+	+	+
Traubenzucker (Glukose) - wässrig	Dextrose (glucose) - aqueux	Dextrose (glucose) - aqueous	C ₆ H ₁₂ O ₆	+	+	+	+	+	+	+	+	+	+	+	+	+
Tributylphosphat - rein	Tributylphosphate - pur	Tributylphosphate - pure	PO(OC ₄ H ₉) ₃	-	-	-	o	-	+	+	+	+	+	+	-	-
Trichloressigsäure - wässrig	Acide trichloroacétique - aqueux	Trichloroacetic acid - aqueous	(Cl) ₃ CCOOH	o	o	-	+		-	+	-	-	-	+	o	-
Trichlorethylen - rein	Trichloroéthylène - pur	Trichloroethylene - pure	Cl ₂ CCl	-	-	o	+	-	-	+	-	+	+	+	+	-
Trichlormethan (Chloroform)	Trichlorométhane (chloroforme)	Trichloromethane (chloroform)	CHCl ₃	-	-	+	+	-	-	+	+	+	+	o	+	-
Triethanolamin - rein	Triéthanolamine - pure	Triethanolamine - pure	N(CH ₂ CH ₂ OH) ₃	-	-	-	+		+	+	o	+	+	+	+	o
Tri­kresylphosphat - rein	Tricrésylphosphate - pur	Triorthocresylphosphate - pure	C ₂₁ H ₂₁ PO ₄	-	-	-	+	o	+	+	o	+	+	+	-	+
Uranhexafluorid - rein	Hexafluorure d'uranium - pur	Uranium hexafluoride - pure	UF ₆	+	+	+	o			+		+	o	+		-
UV-Lack	Peinture UV	UV varnish		-	+	-				+						
Vaselinöl (Mineralöle)	Huile de vaseline (huiles minérales)	Vaseline oil (mineral oil)		+	-	+	+		-	+	+	+	+	+	+	+
Vinylacetat - rein	Acétate de vinyle - pur	Vinyl acetate - pure	CH ₂ CHOOCH ₂ CH ₃	+	+	+	+		+	+	o	+	+	+	+	o
Vinylchlorid - rein	Chlorure de vinyle - pur	Vinyl chloride - pure	CH ₂ CHCl	-	o	+	+	-		+	-	o	+	+	+	+
Waschmittel (synth. Haushalts­waschmittel)	Détergent (détergent domestique synth.)	Detergent (synth. household detergent)		o	+	o	+		+	+	o	+	+	+	+	o
Wasser - destilliert	Eau - distillée	Water - distilled	H ₂ O	+	+	+	+	+	+	+	o	+	+	+	+	+
Wasser - Meerwasser	Eau - Eau de mer	Water - seawater	H ₂ O	+	+	+	+	+	+	+	o	o	o	o	+	+
Wasserdampf - (Elastomer­dichtungen bis +130 °C)	Vapeur aqueuse (joints d'élastomère jusqu'à +130 °C)	Steam - (elastomer seals up to +130 °C)	H ₂ O	o	+	3+	+	-		+	o	+	+	+	+	-
Wasserglas (Natriumsilikate)	Verre soluble (silicate de sodium)	Soluble glass (sodium silicate)		+	+	+	+		+	+	o	+	+	+	+	+
Wasserstoff - rein	Hydrogène - pur	Hydrogen - pure	H ₂	+	+	+	+	+	+	+	+	+	+	+	+	-
Wasserstoffperoxid 0.5 %	Peroxyde d'hydrogène 0.5 %	Hydrogen peroxide 0.5 %	H ₂ O ₂	o	+	+	+	+	+	+	-	+	o	o	+	+
Wasserstoffperoxid 30 %	Peroxyde d'hydrogène 30 %	Hydrogen peroxide 30 %	H ₂ O ₂	-	o	3+	+	+	+	+	-	o	-	o	+	-
Weine	Vins	Wines		+	+	+			+	+	-	+	+	-	+	-
Weinessig	Vinaigre de vin	Wine vinegar		-	o	-	o		o	+	-	o	o	+	+	o
Weinsäure - wässrig	Acide tartrique - aqueux	Tartaric acid - aqueous		+	+	+	+	+	+	+	-	+	+	-	+	o
Xenon	Xénon	Xenon	Xe													+
Xylol - rein	Xylol - pur	Xylene - pure	C ₆ H ₄ (CH ₃) ₂	-	-	+	+	-	-	+	+	+	+	+	+	+
Zinkchlorid - wässrig	Chlorure de zinc - aqueux	Zinc chloride - aqueous	ZnCl ₂	+	+	+	+	o	+	+	-	o	-	o	+	-
Zinksulfat - wässrig	Sulfate de zinc - aqueux	Zinc sulphate (white vitriol) - aqueous	ZnSO ₄	+	+	+	+	o	+	+	-	+	-	o	+	

Chemikalien- beständigkeit	Résistance chimique	Resistance to chemicals													
			NBR	EPDM	FKM	FFKM	PU	LD-PE	PTFE	MS	1.4401/1.4571	1.4305/1.4104	Al	PVDF	PA
Zinnchloride - wässrig	Chlorure d'étain - aqueux	Tin chloride - aqueous	+	+	+	+	+	+	+	-	o	-	-	+	o
Zitronensaft	Jus de citron	Lemon juice	o	+	+			+	+	o	+	o	+	+	+
Zitronensäure - wässrig	Acide citrique - aqueux	Citric acid - aqueous	+	+	+	+	+	+	+	o	+	o	+	+	+
Zuckerlösungen	Solutions sucrées	Sugar solutions	+	+	+			+	+	+	+	+	+	+	+
1) bei Messing mit bis zu 58 % Cu	1) pour le laiton, jusqu'à 58 % de Cuivre	1) for brass with up to 58 % Cu													
2) diffundiert durch EPDM-Membranen; greift Epoxidharz an	2) diffusé par des membranes EPDM; attaque les résines d'époxy	2) diffuses through EPDM membrane; attacks epoxy resin													
3) FKM in säurebeständiger Ausführung mit Bleiglätte	3) FKM est une version acidifiée avec une application de litharge	3) FKM in acid-resistant version with litharge													
4) Ozon schädigt die meisten polymeren Werkstoffe. Die Beständigkeiten sind daher zu relativieren	4) L'ozone dégrade la plupart des matériaux polymères. La compatibilité devra être relativisée.	4) ozone damages most polymeric materials. Resistance should therefore be relativised.													
5) unter Druck getestet durch die BAM	5) Utilisation testée sous pression selon réglementation BAM	5) tested under pressure according to BAM													
6) Wasserstoff kann zur Versprödung von Metallen führen	6) l'hydrogène est susceptible de fragiliser les métaux.	6) hydrogen can cause metals to become brittle													

KONVANTON

Allgemeine Verkaufs- und Lieferbedingungen

Conditions générales de vente et de livraison

General terms of sale and delivery

1. Allgemeines und Geltungsbereich

Die Allgemeinen Geschäftsbedingungen gelten für alle SERTO Group Gesellschaften (SERTO AG, SERTO GmbH, SERTO S.A.R.L., EXMAR GmbH, SERTO Italiana S.r.l., SERTO CZ s.r.o. und SERTO US Inc.) im folgenden "Lieferant" genannt. Die Angebote, Auftragsbestätigungen, Lieferungen und Leistungen erfolgen ausschließlich aufgrund dieser Geschäftsbedingungen. Änderungen, Ergänzungen oder entgegenstehende Bedingungen des Auftraggebers/Käufers/Bestellers gelten nur dann, wenn sie von uns im Einzelfall ausdrücklich schriftlich bestätigt werden. Mit der Auftragserteilung, spätestens jedoch mit dem Empfang der Ware, gelten unsere Allgemeinen Verkaufs- und Lieferbedingungen vom Käufer als angenommen.

2. Angebot und Vertragsabschluss

Unsere Angebote sind freibleibend. Schriftlich, mündliche oder fernmündlich erteilte Aufträge werden erst durch unsere schriftliche Auftragsbestätigung für uns verbindlich. Bei Fertigung nach Kundenmuster/-zeichnung behalten wir uns eine Mehr- bzw. Minderlieferung bis zu 10 % (bei Auftragsmenge kleiner als 10 Stück behalten wir uns eine Mehr- bzw. Minderlieferung von 1 Stück) vor.

Bei Bestellung auf der Grundlage der jeweils neuesten Ausgabe unserer Unterlagen, wie Kataloge, Preislisten oder Prospekte, ist zu berücksichtigen, dass unsere Angaben (insbesondere die technischen) insoweit unverbindlich sind, soweit nicht anderes ausdrücklich vereinbart ist oder sich aus einer entsprechenden Bezeichnung in den Unterlagen ergibt. Im Übrigen verstehen sich unsere Angaben in Unterlagen, wie Katalogen oder Prospekten, als Aufforderung zur Abgabe eines Angebotes. Eine vertragliche Bindung unsererseits bedarf einer schriftlichen Auftragsbestätigung, welche zugleich den Umfang der vertraglichen Verpflichtung festlegt. Weichen in der Auftragsbestätigung Angaben vom Angebot des Auftraggebers/Käufers/Bestellers ab, hat dieser unverzüglich zu widersprechen, wenn der Vertrag nicht zu diesen geänderten Bedingungen zustande kommen soll. Nachträgliche Ergänzungen, Änderungen oder Nebenabreden bedürfen der Schriftform. Wenn sich die Zahlungsfähigkeit oder die Vermögensverhältnisse des Auftraggebers/Käufers/Bestellers nach Vertragsabschluss so wesentlich verändert haben, dass unser Anspruch auf die Gegenleistung gefährdet wird, sind wir berechtigt, die Erfüllung des Vertrages zu verweigern, bis der Auftraggeber/Käufer/Besteller die Gegenleistung bewirkt oder Sicherheit für sie geleistet hat. Ist der Auftraggeber/Käufer/Besteller nicht in der Lage, innerhalb angemessener Frist die geforderte Sicherheit zu leisten, so sind wir zum Rücktritt berechtigt.

3. Preise / Lieferung

Preise des Lieferanten sind freibleibend und werden von der SERTO GmbH, SERTO S.A.R.L., SERTO Italiana S.r.l. und EXMAR GmbH in Euro, von der SERTO AG in Schweizer Franken (CHF) und von SERTO US Inc. in US-Dollar (USD) angegeben und gelten ab Werk (INCOTERMS 2020), jedoch ausschließlich Verpackung, Transportkosten, Zuschläge für Mindestauftragswert (Mindermengenzuschläge), Versicherung und der jeweils gültigen gesetzlichen Mehrwertsteuer.

Die Umsatzsteuer wird gesondert ausgewiesen zu dem am Tage der Rechnungsstellung gültigen Steuersatz. Lieferungen erfolgen immer ab Werk.

4. Lieferungen, Liefer- und Leistungszeit

Die Vereinbarung von Terminen und Fristen bei Vertragsabschluss bedarf der Schriftform. Dasselbe gilt für deren nachträgliche Vereinbarung oder Änderung.

1. Généralités et champ d'application

Les présentes conditions générales s'appliquent à toutes les sociétés du SERTO Group (SERTO AG, SERTO GmbH, SERTO S.A.R.L., EXMAR GmbH, SERTO Italiana S.r.l., SERTO CZ s.r.o. et SERTO US Inc.), appelées par la suite "Fournisseur". Les présentes conditions générales s'appliquent en exclusivité à toutes les offres, confirmations de commandes, livraisons et prestations. Les modifications, compléments ou conditions divergentes du mandant/de l'acheteur/du client ne sont valides que si nous les acceptons expressément par écrit. Les présentes conditions générales de vente et de livraison sont considérées acceptées par le client avec la passation de la commande, au plus tard lors de la réception des marchandises.

2. Offre et conclusion du contrat

Nos offres ont un caractère indicatif. Les commandes passées par écrit, oralement ou par téléphone ne sont considérées fermes qu'après la confirmation écrite de la commande de notre part. En cas d'une fabrication selon un modèle ou dessin du client, nous nous réservons de droit de diminuer ou d'augmenter la quantité de 10 % au maximum (pour les quantités inférieures à 10 pièces, nous réservons le droit de livrer une pièce de plus ou de moins).

Pour une commande basée sur la version la plus récente de notre documentation, comme nos catalogues, listes de prix ou prospectus, il convient de considérer que, sans convention contraire explicite, les informations (en particulier les informations techniques) sont données à titre indicatif si cela n'est pas précisé autrement dans la documentation. Par ailleurs, les informations contenues dans la documentation comme des catalogues ou prospectus s'entendent comme une incitation de formuler une offre. Une convention contractuelle ne pourra être ferme de notre part que moyennant une confirmation écrite de la commande, spécifiant en même temps l'envergure de l'obligation sous le contrat. Si des informations contenues dans la confirmation de la commande sont contradictoires par rapport à l'offre du mandant/de l'acheteur/du client, ce dernier devra nous en aviser immédiatement s'il ne souhaite pas conclure le contrat sous les conditions stipulées dans la confirmation de la commande. Tous les compléments, modifications et conventions secondaires doivent être soumis et acceptés sous forme écrite. Si la solvabilité ou les liquidités du mandant/de l'acheteur/du client changent considérablement après la conclusion du contrat dans la mesure où notre droit de compensation semble compromis, nous avons le droit de refuser l'accomplissement du contrat jusqu'à ce que le mandant/l'acheteur/le client nous fournisse une compensation ou une sécurité pour une telle compensation. Nous avons le droit d'annuler le contrat si le mandant/l'acheteur/le client n'est pas à même de fournir la sécurité requise dans le délai imparti.

3. Prix / Livraison

Les prix du fournisseur sont indicatifs, par SERTO GmbH, SERTO S.A.R.L., SERTO Italiana S.r.l. et EXMAR GmbH en euro, par SERTO AG en francs suisses (CHF), par SERTO US Inc. en dollars US (USD), départ usine (INCOTERMS 2020), sans emballage, sans frais de transport, sans majorations pour petites quantités, sans assurance et hors la TVA applicable.

La taxe sur le chiffre des ventes est justifiée séparément au taux valable le jour de la facturation. Toutes les livraisons sont départ usine.

4. Livraisons, délai de livraison et de prestation

Les délais et échéances doivent être précisés par écrit lors de la conclusion du contrat. Toute convention ou modification ultérieure doit également être soumise et

1. General and Scope of Validity

The General Terms and Conditions shall apply to all companies within the SERTO Group (SERTO AG, SERTO GmbH, SERTO S.A.R.L., EXMAR GmbH, SERTO Italiana S.r.l., SERTO CZ s.r.o. and SERTO US Inc.), hereinafter referred to as the "Supplier". These General Terms and Conditions shall be exclusively valid for offers, order confirmations, deliveries and services. Modifications, supplements or conflicting conditions of the customer/purchaser/orderer shall only be applicable when expressly confirmed in writing in each individual case. By placing the order, or at the latest upon receipt of the goods, the purchaser acknowledges our General Terms and Conditions of Sale and Delivery.

2. Offers and Contracts

Our offers are subject to change. Orders placed in writing, verbally or by telephone shall only become binding for us with our written order confirmation. For manufactures according to customer samples/drawings, we reserve the right to an excess or short delivery of up to 10 % (for order quantities under 10 pieces, we reserve the right to an excess or short delivery of 1 piece).

With respect to orders based on the most recent version of our documentation, such as catalogues, price lists or brochures, it shall be borne in mind that our information (in particular technical data) is non-binding in so far as no other agreements are specifically made or corresponding designation is contained in the documentation. In addition, our information in documentation, such as catalogues or brochures, shall be understood as an invitation to submit a quotation. A binding contract for our part requires a written order confirmation which establishes the extent of the contractual obligation. Should the order confirmation show information which deviates from that in the offer of the customer/purchaser/orderer, he must notify us immediately if the contract is not to be pursued under these altered conditions. Subsequent additions, modifications or other agreements must be made in writing. If, after conclusion of the contract, the ability to pay or the financial circumstances of the customer/purchaser/orderer have deteriorated to the extent that our right to compensation is jeopardised, we shall be entitled to refuse fulfilment of the contract until which time the customer/purchaser/orderer shall effect such consideration or provide a security for it. Should the customer/purchaser/orderer not be able to provide the required security within an appropriate time, we shall be entitled to withdraw from the contract.

3. Prices / Delivery

The Supplier's prices shall be subject to change and are given by SERTO GmbH, SERTO S.A.R.L., SERTO Italiana S.r.l. and EXMAR GmbH in Euro, by SERTO AG in Swiss francs (CHF), by SERTO US Inc. in US dollars (USD), ex works (INCOTERMS 2020), but excluding packaging, transport costs, minimum order charge, insurance and the applicable statutory value-added tax.

The sales tax shall be shown separately at the rate applicable on the day of invoicing. Deliveries shall always be made ex works.

4. Deliveries, Time of Delivery and Performance

The dates and deadlines must be agreed in writing upon conclusion of the contract. The same holds true for subsequent agreements or amendments. Adherence to a delivery time shall be subject to the timely receipt of all documents, parts and information to be supplied by the customer/purchaser/orderer as well as any advance payments contractually or legally owed by the customer/purchaser/orderer. If these requirements are not met, the delivery time shall be extended accordingly.

AGB Fortsetzung

Die Einhaltung einer Lieferfrist setzt den rechtzeitigen Eingang sämtlicher vom Auftraggeber/Käufer/Besteller zu liefernden Unterlagen, Teile und Angaben sowie die Erbringung von vertraglich oder gesetzlich geschuldeten Vorleistungen des Auftraggeber/Käufer/Bestellers voraus. Werden diese Voraussetzungen nicht erfüllt, verlängert sich die Lieferfrist entsprechend. Als Tag der Lieferung gilt der Tag, an dem die Ware dem Auftraggeber/Käufer/Besteller abholbereit gemeldet wurde. Falls Versendung geschuldet ist, gilt als Tag der Lieferung der Tag, an dem die Ware an die Transportperson übergeben wird. Liefer- und Leistungsschwierigkeiten aufgrund von Ereignissen höherer Gewalt, die erst nach Abschluss des Vertrages eintreten und uns auch erst danach ohne Verschulden bekannt werden (wie z. B. unvorhersehbare Betriebsstörungen, Streiks, Aussperrungen, unvermeidbare Materialbeschaffungsschwierigkeiten und dergleichen), haben wir nicht zu vertreten. Ist das Leistungshindernis vorübergehender Art, so verlängert sich die Liefer- und Leistungszeit angemessen. Hat das Ereignis höherer Gewalt dauerndes Unvermögen zur Folge, so sind wir berechtigt, wegen des noch nicht erfüllten Teiles ganz oder teilweise von dem Vertrag zurückzutreten. Bei Abrufaufträgen, deren Erfüllung aus mehreren Teillieferungen besteht, können aus Lieferstörungen bei einer Teillieferung keine Rechte wegen anderer Teillieferungen dieses Auftrages geltend gemacht werden, es sei denn, der Auftraggeber/Käufer/Besteller weist nach, dass die teilweise Erfüllung des Vertrages für ihn kein Interesse hat. Dasselbe gilt, wenn die Teillieferung im Verhältnis zur Gesamtlieferung geringfügig ist. Bei Abrufaufträgen, deren Erfüllung aus mehreren Teillieferungen besteht, sind wir berechtigt, die gesamte Bestellmenge sofort herzustellen. Etwaige Änderungswünsche des Auftraggebers/Käufers/Bestellers können nach Erteilung unserer Auftragsbestätigung nicht mehr berücksichtigt werden. Zu Teillieferungen und Teilleistungen sind wir in zumutbarem Umfang berechtigt. Unvermeidbare Mengenabweichungen/Fertigungsergebnisse nach oben oder unten bis zu 10 % sind ohne entsprechende Anpassung des Kaufpreises anzuerkennen.

5. Gefahrübergang

Wir liefern auf Gefahr und Kosten des Auftraggebers/Käufers/Bestellers. Die Gefahr geht auf den Auftraggeber/Käufer/Besteller über, sobald die Ware zwecks Versendung unser Werk oder eines unserer Aussenlager verlassen hat. Wird der Versand durch Umstände verzögert oder unmöglich, die der Auftraggeber/Käufer/Besteller zu vertreten hat, so geht die Gefahr am Tage der Meldung der Versandbereitschaft auf den Auftraggeber/Käufer/Besteller über. Angelieferte Gegenstände sind, auch wenn sie Mängel aufweisen, vom Auftraggeber/Käufer/Besteller unbeschadet der Rechte aus Abschnitt 6. entgegenzunehmen.

6. Gewährleistung

Geringfügige und/oder unerhebliche Abweichungen oder Änderungen gegenüber den Katalogen oder früher gelieferten Waren gelten nicht als Mangel. Unsere Angaben zum Liefer- und Leistungsgegenstand in unseren Katalogen, Prospekten und Preislisten stellen lediglich Beschreibungen, Kennzeichnungen und Richtwerte dar. Die Zusicherung von Eigenschaften und der Ausschluss branchenüblicher Abweichungen bedürfen in jedem Einzelfall der ausdrücklichen schriftlichen Vereinbarung. Für die von uns gelieferten Waren gelten die jeweils in den Ländern gültigen Untersuchungs- und Rügepflichten. Der Auftraggeber/Käufer/Besteller hat uns etwaige Mängel unverzüglich, erkennbare Mängel spätestens innerhalb 1 Woche nach Eingang der Ware, verdeckte Mängel spätestens innerhalb von 1 Woche nach Entdeckung unter

Conditions générales continuation

acceptée par écrit. Le respect d'un délai de livraison n'est possible que si tous les documents, pièces et indications à fournir par le mandant/l'acheteur/le client ainsi que les prestations de compensation avancées dues par le mandant/l'acheteur/le client nous parviennent à temps. Le délai de livraison se prolongera en conséquence si ces conditions ne sont pas remplies. Le jour de livraison est jour où le mandant/l'acheteur/le client est avisé que la marchandise est prête pour être enlevée. Si nous devons envoyer les marchandises, c'est le jour de livraison où les marchandises sont transmises au transporteur. Nous ne pouvons pas être tenus responsables des problèmes de livraison et de prestations dus à une force majeure se produisant après la conclusion du contrat et dont nous prenons connaissance seulement ultérieurement sans faute de notre part (p. ex. des interruptions de l'exploitation imprévisibles, des grèves, lock-out, difficultés d'approvisionnement en matériel imprévisibles etc.). Si l'empêchement de fournir la prestation est passager, le délai de livraison et de prestation sera prolongé en conséquence. Si l'incident de force majeure provoque une incapacité permanente, nous avons le droit d'annuler le contrat entièrement ou partiellement pour la partie non accomplie. Pour les commandes sur demande réalisées moyennant plusieurs livraisons partielles, il n'est pas possible de faire valoir un droit pour une livraison partielle en raison d'une autre livraison partielle, à moins que le mandant/l'acheteur/le client ne justifie que la réalisation partielle du contrat soit sans intérêt pour lui. Cela est également valable pour les livraisons partielles mineures par rapport à la livraison totale. Pour les commandes sur demande réalisées moyennant plusieurs livraisons partielles, nous avons le droit de fabriquer toute la quantité commandée en même temps. Il n'est plus possible de prendre compte les éventuels souhaits de modification du mandant/de l'acheteur/du client après la confirmation de la commande. Nous avons le droit de fournir des livraisons et prestations partielles pour autant que cela soit équitable. Les différences de quantité et de résultats de la fabrication inévitables doivent être acceptées jusqu'à une limite supérieure ou inférieure de 10 %.

5. Transfert du risque

Nous livrons au risque et aux périls du mandant/de l'acheteur/du client. Le risque est transféré au mandant/à l'acheteur/au client dès que les marchandises ont quitté l'usine ou l'entrepôt externe pour être expédiées. Si l'expédition est retardée ou impossible pour des circonstances dont le mandant/l'acheteur/le client est responsable, le risque sera transféré au mandant/à l'acheteur/ au client le jour de l'avis de la possibilité d'expédition. Les objets livrés doivent être réceptionnés par le mandant/l'acheteur/le client, même s'ils présentent un défaut, sans préjudice des droits sous paragraphe 6.

6. Garantie

Les différences ou modifications mineures et/ou sans importance par rapport aux catalogues ou aux marchandises livrées auparavant ne sont pas considérées comme des défauts. Nos indications relatives à l'objet de la livraison ou de la prestation dans nos catalogues, prospectus et listes de prix représentent uniquement des descriptions, caractérisations et valeurs indicatives. Toute promesse relative à des propriétés et en excluant les différences habituelles pour la branche doit être établie explicitement et par écrit. Pour les marchandises livrées par nos soins, les obligations d'inspection et de réclamation nationales font foi. Le mandant/l'acheteur/le client doit nous transmettre les éventuelles réclamations pour des vices de transport immédiatement, pour des vices apparents dans une semaine suivant la livraison et pour des vices cachés dans une semaine suivant leur détection avec une description complète du vice. Toute garantie est exclue si le délai des réclamations

Terms and Conditions continuation

The day of delivery shall be considered the day on which the goods are reported to the customer/purchaser/orderer as ready for pickup. If shipping is owed, the day of delivery shall be the day on which the goods are consigned to the forwarder. We shall not bear responsibility for delivery and performance difficulties due to force majeure events that take effect after conclusion of the contract and that are only known to us after the fact through no fault of our own (such as e.g. unforeseeable interruptions in operation, strikes, lockouts, unavoidable difficulties in material procurement and the like). If the obstacle to performance is of a temporary nature, the delivery and performance time shall be extended accordingly. If, however, the event of force majeure should result in a permanent inability to perform, we shall be entitled to withdraw as a whole or in part from the contract concerning the part not yet fulfilled. For call orders consisting of several partial shipments, no rights may be asserted for other partial shipments of this order on the basis of delivery problems for one partial shipment unless the customer/purchaser/orderer submits proof that partial fulfilment of the contract is of no interest to him. The same applies should the partial shipment be insignificant in comparison to the overall delivery. For call orders consisting of several partial shipments, we shall be entitled to manufacture the entire order amount immediately. Any change requests on the part of the customer/purchaser/orderer cannot be taken into account after our order confirmation has been issued. We are entitled to make partial deliveries and partial performance to a reasonable extent. Unavoidable upward or downward deviations in amounts / manufacturing results of up to 10% shall be allowed without any adjustments in the purchase price.

5. Passing of risk

We deliver at the risk and cost of the customer/purchaser/orderer. Risk passes to the customer/purchaser/orderer as soon as the goods leave our plant or one of our external storage areas for shipment. If shipment is delayed or not possible due to circumstances for which the customer/purchaser/orderer is responsible, the risk shall pass to the customer/purchaser/orderer on the day of notification of readiness to dispatch. The customer/purchaser/orderer shall accept delivered goods even if they exhibit defects irrespective of the rights stipulated in Paragraph 6.

6. Warranty

Minor and/or insignificant deviations or modifications compared to the catalogues or previously supplied goods shall not be considered a defect. The information regarding our goods and services provided in our catalogues, brochures and price lists merely constitutes descriptions, identifications and reference values. The assurance of characteristics and the exclusion of deviations customary in the trade shall be subject to explicit written agreement in each individual case. For goods supplied by us, the inspection duties and the complaint notification obligation valid in the respective countries shall apply. The customer/purchaser/orderer must report any defects immediately to us in writing and in full; visible defects are to be reported at the latest within one week of receipt of the goods, hidden defects at the latest within one week of detection. Warranty claims may not be put forward after the notification period has elapsed, as well as after 24 months of the passing of risk. For justified and accurately timed notifications of defect, our warranty obligation shall be limited, at our discretion, to reworking the goods or replacing them. Regardless of the fact whether we rework or supply new parts, only parts that exhibit a defect in the material or in our workmanship shall be replaced. Should subsequent deliveries or improvements fail, the customer/purchaser/orderer may only choose to demand a reduction in payment or termination of the contract. Claims for damages by the customer/purchaser/orderer

AGB Fortsetzung

eingehender Beschreibung schriftlich mitzuteilen. Die Geltendmachung von Gewährleistungsansprüchen ist ausgeschlossen, falls Mängelrügefristen versäumt werden, ferner falls seit Gefahrübergang 24 Monate verstrichen sind. Im Falle rechtzeitiger und berechtigter Mängelrügen ist unsere Gewährleistungspflicht nach unserer Wahl auf Nachbesserung oder Ersatzlieferung beschränkt. Bessern wir nach oder liefern wir neu, werden nur Teile ersetzt, die einen Fehler in Werkstoff oder in der von uns geleisteten Werkarbeit aufweisen. Schlagen Nachlieferungen oder -besserungen fehl, so kann der Auftraggeber/Käufer/Besteller nur Herabsetzung der Vergütung oder nach seiner Wahl Rückgängigmachung des Vertrages verlangen. Für Schadensersatzansprüche des Auftraggebers/Käufers/Bestellers gilt Abschnitt 7. Schadensersatz wegen eines etwaigen Mängelfolgeschadens steht dem Auftraggeber/Käufer/Besteller nur für den Fall zu, dass bei Nichtvorliegen von uns ausdrücklich zugesicherter Eigenschaften das Risiko eines Mängelfolgeschadens durch die zugesicherte Eigenschaft ausgeschlossen werden sollte. Jegliche Gewährleistung ist ausgeschlossen für Mängel, die auf Nichtbefolgen oder Nichteinhalten der Montageanweisung und Einbauempfehlungen, auf fahrlässiger oder unsachgemäßer Behandlung, auf anderen Einsätzen oder anderer Verwendung unserer Waren oder unserer Leistungen als vertraglich vorgesehen, auf angelegenen Fremdmitteln oder auf Änderungen oder Instandsetzungsarbeiten beruhen, die seitens des Auftraggebers/Käufers/Bestellers oder Dritter unsachgemäß ohne unsere vorherige Genehmigung vorgenommen worden sind. Liegt ein Ausschlussatbestand vor, trägt der Auftraggeber/Käufer/Besteller die Beweislast dafür, dass der von ihm geltend gemachte Mangel nicht durch ein zum Ausschluss führendes Verhalten verursacht wurde.

7. Schadensersatzansprüche

Wir haften nicht für bei Vertragsabschluss nicht vorhersehbare Schäden aller Art infolge Nichtlieferung oder verspäteter Lieferung, infolge einer Verletzung sonstiger vertraglicher Pflichten, für die Verletzung von Pflichten bei Vertragsabschluss sowie für Schäden aus unerlaubter Handlung. Das gilt nicht, wenn uns Vorsatz oder grobe Fahrlässigkeit zur Last fällt, wenn es sich um Fälle anfänglichen Unvermögens oder um die Verletzung einer für die Erreichung des Vertragszwecks wesentlichen Verpflichtung oder um die Verletzung einer betrieblichen Organisationspflicht zur Vermeidung von Konstruktions-, Fabrikations- und Gebrauchsmängeln handelt.

8. Eigentumsvorbehalt

Bis zur Erfüllung - bei Zahlung durch Wechsel oder Scheck bis zur erfolgten Einlösung - aller Saldo-Forderungen, die uns, aus welchem Rechtsgrund auch immer, gegen den Auftraggeber/Käufer/Besteller zustehen, bleibt die Ware unser Eigentum. Daneben werden uns die folgenden Sicherheiten gewährt, die wir auf Verlangen nach Wahl des Käufers/Bestellers freigeben, soweit ihr Wert die Forderungen um mehr als 15 % übersteigt. Eine Be- und Verarbeitung erfolgt stets unentgeltlich für uns als Hersteller, jedoch ohne Verpflichtung für uns, so dass wir in jedem Zeitpunkt und Grad der Verarbeitung an den Erzeugnissen Eigentum behalten. Der Auftraggeber/Käufer/Besteller verwahrt unser Eigentum unentgeltlich. Bei Verbindung/Vermischung mit uns nicht gehörenden Waren durch den Verkäufer/Käufer/Besteller und einem dadurch bedingten Eigentumsverlust wird bereits jetzt vereinbart, dass das entstehende Miteigentum des Auftraggebers/Käufers/Bestellers an der neuen Sache in Höhe des Rechnungsendbetrages im Verhältnis zum Wert der neuen Ware nach Verarbeitung anteilmässig zum Zeitpunkt der Verbindung/Vermischung auf uns übergeht und diese unentgeltlich durch den

Conditions générales continuation

n'est pas respecté et si 24 mois sont écoulés depuis le transfert du risque. Si la réclamation nous parvient dans le délai imparti, et si elle est justifiée, notre obligation de garantie est limitée à une réparation ou un remplacement, selon notre choix. En cas d'une réparation ou d'un remplacement, nous le remplacerons que les pièces présentant un défaut du matériau ou de la finition réalisée par nous à l'usine. Si la réparation ou le remplacement ne réussit pas, le mandant/l'acheteur/le client aura le droit de demander une réduction de sa compensation ou d'annuler le contrat, selon son choix. Le paragraphe 7 fait foi pour les dommages-intérêts du mandant/ de l'acheteur/du client. Le mandant/l'acheteur/le client n'aura droit aux dommages-intérêts pour les éventuels dommages consécutifs que si des propriétés explicitement promises de notre part ne sont présentes et qu'il convient d'exclure le risque d'un dommage consécutif dû à leur absence. Toute garantie pour défauts de fabrication suite à un non respect des instructions de montage et d'installation, suite à une utilisation négligente ou non conforme, suite à une utilisation ou une application de nos marchandises ou prestations autre que celle prévue par le contrat, suite à l'application de produits externes ou de modifications ou d'activités de maintenance réalisées par le mandant/l'acheteur/le client ou un tiers de manière incompétente et sans avoir obtenu notre autorisation au préalable est exclue. En cas d'un fait excluant la garantie, le mandant/l'acheteur/le client porte la charge de la preuve que le défaut réclamé de sa part n'a pas été causé par un comportement provoquant l'exclusion.

7. Dommages-intérêts

Nous déclinons toute responsabilité pour les dommages imprévisibles de toute sorte suite à une non-livraison ou une livraison tardive à cause d'une lésion des autres obligations contractuelles, à cause d'une lésion d'une obligation lors de la conclusion du contrat et pour les dommages suite à un acte illicite. Cette clause ne s'applique pas si nous avons agi de manière intentionnelle ou par négligence, quand il s'agit d'une incapacité initiale ou d'une violation d'une obligation essentielle pour la réalisation du contrat, ou s'il s'agit d'une violation d'une obligation d'organisation de l'entreprise en vue d'éviter les défauts de construction, de fabrication et d'utilisation.

8. Réserve de propriété

Les marchandises restent notre propriété jusqu'à la réalisation de toutes nos demandes de compensation contractuelle envers le mandant/l'acheteur/le client, pour quelle raison que ce soit, par paiement par chèque ou lettre de change. Nous avons, en outre, droit aux sécurités suivantes libérées sur demande et selon le choix du mandant/de l'acheteur/ du client pour autant que leur valeur dépasse celle de la créance de plus de 15 %. Le traitement du paiement ne doit pas nous être imputé en tant que fabricant et ne doit représenter aucune obligation pour nous, de sorte que nous puissions préserver le droit de propriété de nos produits à tout moment et à tous les stades du traitement. Le mandant/l'acheteur/le client garde notre propriété sans contre-prestation. En cas d'une composition ou d'un mélange de notre propriété avec des marchandises qui ne nous appartiennent pas par le mandant/l'acheteur/le client et d'une perte de propriété consécutive, nous convenons, d'ores et déjà, que la copropriété du mandant/de l'acheteur/du client au nouvel objet correspondra au montant de la facture finale et dans un rapport proportionnel de la nouvelle marchandise après le traitement au moment de la composition/du mélange nous sera transférée, et que le mandant/l'acheteur/le client conservera la marchandise pour nous. Le mandant/l'acheteur/le client s'engage à traiter notre propriété/copropriété avec tout le soin d'un professionnel contre toute dégradation, diminution ou perte, également envers ses mandants/acheteurs/clients. Le mandant/l'acheteur/le cli-

Terms and Conditions continuation

rer are governed under Paragraph 7. The customer/purchaser/orderer shall be entitled to compensation for any consequential damages caused by a defect only in the event that the risk of consequential damages due to the guaranteed characteristic should be excluded when an expressly guaranteed characteristic is not present. Any warranty is excluded for defects based on non-compliance or non-adherence to the assembly instructions and installation recommendations, on negligent or improper handling, on other applications or other uses of our goods or services than foreseen in the contract, on given outside resources or on modifications or repair work undertaken improperly by the customer/purchaser/orderer or third parties without our prior approval. If there is a state of exclusion, the customer/purchaser/orderer shall bear the burden of proving that the defect asserted by him was not caused by behaviour leading to exclusion.

7. Claims for damages

We shall not be held liable for all types of damages unforeseeable at the time of concluding the contract due to non-delivery or delayed delivery, due to violation of other contractual obligations, for violations of obligations upon conclusion of the contract as well as for damages due to unlawful acts. This does not apply unless it can be shown that we have acted wilfully or with gross negligence, unless it is a case of initial inability or the violation of an obligation essential to meeting contractual ends or the violation of the organisational duty of the company to prevent defects arising from design, production and use.

8. Retention of title

Until the customer/purchaser/orderer has settled all outstanding claims - in case of payment by draft or cheque until redemption of such - to which we are entitled for any legal reason, the goods shall remain our property. In addition, the following securities shall be granted us, which we may release on request at the discretion of the purchaser/orderer, provided their value exceeds the claims by more than 15%. Processing or working the goods is always free for us as the manufacturer, but without any obligation on our part, so that we retain title to the goods at all times and every degree of the processing. The customer/purchaser/orderer shall keep custody of our property free of charge. Should the customer/purchaser/orderer merge or combine our goods with other goods not belonging to us, thus causing a loss of ownership, it is hereby agreed that we shall acquire a share in the joint ownership of the customer/purchaser/orderer in the new item in the total amount of the invoice proportional to the value of the new goods after processing at the time of combining/merging and that the customer/purchaser/orderer shall keep custody of them gratuitously. The customer/purchaser/orderer shall be obligated to protect our property/joint property from deterioration, spoilage or loss with the proper care and diligence, also against his customers/purchasers/orderers. The customer/purchaser/orderer shall be entitled to process and to sell the reserved-title goods in the normal course of business, provided that he is not in arrears. Claims deriving from the resale of the reserved-title goods or other legal reasons pertaining to these goods, including all types of balance claims, are hereby assigned to us by way of security in full together with all ancillary rights. We provisionally authorise him to collect in his own name and for his own account all claims ceded to us and to forward the proceeds to us when payment is due. Has the authorisation to collect been revoked, the customer/purchaser/orderer shall be required at our request to disclose the assignments and to make available to us the necessary information and documents. It is not permitted to pledge or assign the reserved-title goods as a security. If a third party attempts to secure the reserved-title goods, the custo-

AGB Fortsetzung

Auftraggeber/Käufer/Besteller verwahrt wird. Der Auftraggeber/Käufer/Besteller verpflichtet sich, unser Eigentum/Miteigentum mit der Sorgfalt eines ordentlichen Kaufmanns vor Verderb, Minderung oder Verlust zu bewahren, auch gegenüber seinen Auftraggebern/Käufern/Bestellern. Der Auftraggeber/Käufer/Besteller ist berechtigt, die Vorbehaltsware im ordnungsgemässen Geschäftsverkehr zu verarbeiten und zu veräussern, solange er nicht im Verzug ist. Die aus dem Weiterverkauf oder einem sonstigen Rechtsgrund bezüglich der Vorbehaltsware entstehenden Forderungen, auch jede Art von Saldoforderungen, tritt er bereits jetzt sicherungshalber in vollem Umfang und mit allen Nebenrechten an uns ab. Wir ermächtigen ihn widerruflich, die uns abgetretenen Forderungen für eigene Rechnung und in eigenem Namen einzuziehen und den Erlös an uns bei Fälligkeit unserer Forderungen abzuführen. Ist die Einziehungsermächtigung widerrufen, so wird der Auftraggeber/Käufer/Besteller auf unsere Aufforderungen hin die Abtretung offen legen und uns die erforderlichen Auskünfte und Unterlagen zur Verfügung stellen. Verpfändungen oder Sicherungsübereignungen der Vorbehaltsware sind unzulässig. Bei Zugriffen Dritter auf die Vorbehaltsware hat der Auftraggeber/Käufer/Besteller auf unser Eigentum hinzuweisen und uns unverzüglich zu benachrichtigen. Kosten und Schäden trägt der Auftraggeber/Käufer/Besteller. Bei vertragswidrigem Verhalten des Auftraggebers/Käufer/Bestellers, durch das der Wert der Ware als Sicherungsobjekt nicht unwesentlich gefährdet wird, sind wir berechtigt, die Vorbehaltsware nach Mahnung auf seine Kosten zurückzunehmen; der Auftraggeber/Käufer/Besteller ist zur Herausgabe verpflichtet. Die Geltendmachung des Eigentumsvorbehaltes sowie die Pfändung der Vorbehaltsware durch uns gilt nicht als Rücktritt vom Vertrag.

9. Zahlung

Alle Rechnungen sind innerhalb von 20 Tagen nach Rechnungsdatum ohne Abzug zu bezahlen. Bankgebühren gehen zu Lasten des Auftraggebers/Käufer/Bestellers. Alle Zahlungen sind direkt an uns zu leisten. Unsere Vertreter oder Reisenden sind nicht zum Inkasso berechtigt. Soweit der Auftraggeber/Käufer/Besteller keine besondere Nachricht gibt, werden Zahlungen jeweils auf die älteste offene Rechnung angerechnet. Eventuell gesondert schriftlich vereinbarte Skonti, die nur gewährt werden, wenn keine fälligen Rechnungen zur Bezahlung ausstehen, sind aus dem Rechnungsbruttobetrag zu ziehen, also aus der Summe aus Warenwert, Kosten für Nebenleistungen und Mehrwertsteuer. Gerät der Auftraggeber/Käufer/Besteller in Verzug, sind wir berechtigt, vom Eintritt des Verzuges an als Entschädigung ohne Nachweis Zinsen in Höhe von 2 % über dem jeweiligen Diskontsatz zuzüglich der gesetzlichen Mehrwertsteuer zu verlangen, unbeschadet unserer Möglichkeit, einen höheren tatsächlichen Schaden, insbesondere in Höhe des von den Geschäftsbanken üblicherweise berechneten Zinssatzes für offene Kontokorrentkredite, geltend zu machen. Kommt der Auftraggeber/Käufer/Besteller seinen Zahlungsverpflichtungen schuldhaft nicht nach, sind wir berechtigt, sofortige Bezahlung der insgesamt bestehenden Restschuld oder sicherungshalber die einstweilige Herausgabe der gelieferten Ware zu fordern, auch wenn wir Wechsel oder Schecks angenommen haben. Wir sind bei noch zu liefernden Waren ausserdem berechtigt, Vorauszahlung oder zusätzliche Sicherheitsleistungen zu verlangen. Eine Zahlung gilt erst dann als erfolgt, wenn wir über den Betrag verfügen können, Zahlungen per Wechsel oder Scheck gelten erst nach endgültiger Einlösung als eingegangen. Sämtliche mit der Einziehung verbundenen Kosten gehen zu Lasten des Auftraggebers/Käufer/Bestellers. Für etwaige Nachteile wegen nicht formrichtigen oder rechtzeitigen Vorlegens oder Protesterhebung haften

Conditions générales continuation

ent a le droit de traiter les marchandises sous réserve selon les activités ordinaires de son activité commerciale et de les vendre, pour autant qu'il ne soit pas en retard de paiement. Il nous cède, en guise de sécurité, entièrement toutes les créances relatives à la marchandise sous réserve suite à une revente ou pour une autre raison légale ainsi que toute sorte de créance pour solde, avec tous les droits accessoires. Nous lui permettons sous réserve de révocation, d'encaisser les créances qu'il nous a cédées à son propre compte et sous son nom pour nous remettre le montant lorsque nos créances arrivent à échéance. Si cette autorisation d'encaissement est révoquée, le mandant/l'acheteur/le client dévoilera la cession sur notre requête et nous mettra à disposition tous les informations et documents nécessaires. Une mise en gage ou une cession pour sécurité de la marchandise sous réserve n'est pas autorisée. Le mandant/l'acheteur/le client doit aviser les tiers tentant d'accéder à notre marchandise sous réserve de la réserve de propriété et il doit nous en aviser sans délai. Les coûts et dommages sont imputables au mandant/de l'acheteur/du client. En cas d'une action lézant le contrat du mandant/de l'acheteur/du client causant une risque considérable pour la valeur de la marchandise comme objet de sécurité, nous avons le droit de reprendre la marchandise sous réserve à ses frais ; le mandant/l'acheteur/le client est obligé de nous rendre les marchandises. L'exercice du droit de réserve de propriété et la mise en gage de la marchandise sous réserve de notre part ne sont pas considérés comme une annulation du contrat.

9. Paiement

Toutes les factures sont à régler dans les 20 jours suivant la date de facturation, sans escompte. Les frais bancaires sont à charge du mandant/de l'acheteur/du client. Tous les paiements doivent nous parvenir directement. Nous représentants ou agents n'ont pas le droit d'encaissement. Sans avis du mandant/de l'acheteur/du client, les paiements sont toujours imputés à la facture la plus ancienne encore ouverte. Les escomptes éventuellement convenus séparément et par écrit sous condition qu'une facture ne soit ouverte et due pour paiement peuvent être déduits du montant brut de la facture, donc de la somme de la valeur des marchandises, des frais pour les prestations accessoires et de la TVA. Si le mandant/l'acheteur/le client est en retard de paiement, nous avons le droit de percevoir des intérêts de 2 % au-dessus du taux d'escompte pratiqué majorés par la TVA légale à compter de la date du début du retard sans justification, sans préjudice du droit de faire valoir un dommage réel supérieur, notamment à hauteur du taux d'intérêt bancaire pour les crédits de compte courant ouverts. Si le mandant/l'acheteur/le client reste en défaut pour ses obligations de paiement, nous avons le droit d'exiger le paiement immédiat de toute la créance encore due ou la remise des marchandises livrées pour sécurité, même si nous avons accepté des chèques ou lettre de change. Nous avons en outre le droit d'exiger un acompte ou des sécurités supplémentaires pour les marchandises à livrer. Le paiement est considéré effectué quand nous pouvons disposer du montant, les paiements par chèque ou lettre de change seulement lorsque nous les avons encaissés. Tous les frais liés à l'encaissement sont à charge du mandant/de l'acheteur/du client. Nous sommes uniquement responsables pour les éventuels désavantages pour une présentation ou réclamation non conforme formellement ou tardive en cas d'une intention ou d'une négligence grave de notre part. Le mandant/l'acheteur/le client ne pourra compenser nos créances avec d'autres créances que si ces dernières sont incontestées par nous-mêmes ou si elles ont été confirmées légalement. Le droit de rétention est exclu. Cela concerne en particulier les droits et créances dérivant des demandes de prestations sous garantie.

Terms and Conditions continuation

mer/purchaser/orderer shall inform them of our ownership and notify us immediately. Costs and damages shall be borne by the customer/purchaser/orderer. In case of breach of contract on the part of the customer/purchaser/orderer by which the value of the goods as a security is not insignificantly endangered, we shall be authorised to take back upon reminder the reserved-title goods at his cost; the customer/purchaser/orderer shall be obligated to surrender the goods. Neither the assertion of title retention nor the pledging of the reserved-title goods shall constitute a withdrawal from the contract.

9. Payment

All invoices shall be payable in full within 20 days of the invoice date. Bank fees are to be paid by the customer/purchaser/orderer. All payments are to be made directly to us. Our representatives or travelling salespeople are not authorised to collect payment. Unless otherwise noted by the customer/purchaser/orderer, incoming payments shall be applied to the oldest unpaid invoice. Any special discounts agreed upon in writing, which are only granted if there are no outstanding invoices to be paid, are to be taken from the gross invoice amount, i.e. from the sum of the value of the goods, costs for additional services and value-added tax. If the customer/purchaser/orderer falls behind in payments, we shall be entitled to charge interest in the amount of 2% above the current discount rate plus the statutory value-added tax as compensation without proof from the time of default, regardless of the possibility to claim for higher actual damages, especially in the amount of the interest rate normally charged by commercial banks for overdrafts. If the customer/purchaser/orderer culpably does not meet his payment obligations, we shall be entitled to demand immediate payment of the entire outstanding balance or by way of security the provisional return of the supplied goods, even if we have accepted drafts or cheques. We shall furthermore be entitled to request advance payment or additional securities for goods not yet delivered. A payment shall be deemed effected when we can dispose of the amount; draft or cheque payments shall only be considered as being received upon final redemption. All costs incurred in the collection of payments shall be borne by the customer/purchaser/orderer. We shall only be liable for any disadvantages due to incorrect or untimely presentation or protest if we are charged with wilful or gross negligence. The customer/purchaser/orderer shall only be entitled to offset such claims against our payment demand which are undisputed by us or have been determined to be legally valid. The assertion of the right to retention is excluded. This pertains in particular to rights and demands derived from warranty claims.

10. Confidentiality

Unless otherwise expressly agreed in writing, the information provided to us in connection with orders shall not be regarded as confidential. Data made known to us during processing of the contract are stored in accordance with the applicable data protection laws.

11. Chemicals

Our chemical products, e.g. lubricants or sealants may only be used for commercial purposes by the customer/purchaser/orderer. They must not be given to private persons and must not be accessible to children or young people.

12. Data protection

The company may process and use the data recorded within the limits of the conclusion of the contract for execution of obligations under the contract. The company takes the measures necessary to secure the data in accordance with the legal regulations. The customer fully agrees to the storage and contractual use of his data by the company and is aware that the company

AGB Fortsetzung

wir nur, wenn uns Vorsatz oder grobe Fahrlässigkeit zur Last fällt. Gegenüber unseren Zahlungsforderungen kann der Auftraggeber/Käufer/Besteller nur mit solchen Forderungen aufrechnen, die von uns unbestritten oder die rechtskräftig festgestellt sind. Die Geltendmachung von Zurückbehaltungsrechten ist ausgeschlossen. Dies gilt insbesondere auch für Rechte und Forderungen, die aus Gewährleistungsansprüchen hergeleitet werden.

10. Geheimhaltung

Falls nicht ausdrücklich schriftlich anders vereinbart, gelten die Informationen, die uns im Zusammenhang mit Bestellungen bekannt werden, nicht als vertraulich. Daten, die uns bei der Vertragsabwicklung zugänglich werden, werden im Sinne des jeweils anwendbaren Datenschutzgesetzes gespeichert.

11. Chemikalien

Unsere chemischen Produkte wie z.B. Schmierstoffe oder Abdichtmittel dürfen vom Auftraggeber/Käufer/Besteller nur für gewerbliche Zwecke verwendet werden. Sie dürfen nicht an Private abgegeben werden und dürfen nicht in die Hände von Kindern/Jugendlichen gelangen.

12. Datenschutz

Die Unternehmung darf die im Rahmen des Vertragschlusses aufgenommenen Daten zur Erfüllung der Verpflichtungen aus dem Vertrag verarbeiten und verwenden. Die Unternehmung ergreift die Massnahmen welche zur Sicherung der Daten gemäss den gesetzlichen Vorschriften erforderlich sind. Der Kunde erklärt sich mit der Speicherung und vertragsgemässen Verwertung seiner Daten durch die Unternehmung vollumfänglich einverstanden und ist sich bewusst, dass die Unternehmung auf Anordnung von Gerichten oder Behörden verpflichtet und berechtigt ist, Informationen vom Kunden diesen oder Dritten bekannt zu geben. Hat der Kunde es nicht ausdrücklich untersagt, darf die Unternehmung die Daten zu Marketingzwecken verwenden sowie für Werbezwecke an Ihre Partner weitergeben. Die zur Leistungserfüllung notwendigen Daten können auch an beauftragte Dienstleistungspartner oder sonstige Dritte weitergegeben werden. Des Weiteren findet die Datenschutzerklärung Anwendung. Die Datenschutzerklärung ist auf der Website der SERTO resp. EXMAR zu finden.

13. Teilwirksamkeit

Auch bei rechtlicher Unwirksamkeit einzelner Punkte bleibt der Vertrag im Übrigen für beide Teile wirksam. Sollten im Übrigen einzelne der vorstehenden Bedingungen unwirksam oder aus einem sonstigen Grund nicht anwendbar sein, so bleiben die übrigen Bestimmungen gültig. Eine unwirksame Bestimmung ist durch eine entsprechende Regelung des dispositiven Rechts zu ersetzen.

14. Anwendbares Recht / Gerichtsstand

Erfüllungsort ist der Ort des Lieferwerks. Die Vertragsparteien vereinbaren die Anwendung des materiellen Rechts am Sitz des Lieferanten. Die Anwendbarkeit des UN Übereinkommens über den internationalen Warenkauf (WKR/CISG) wird ausdrücklich ausgeschlossen. Für mögliche bzw. allfällige Streitigkeiten aus diesem Vertrag vereinbaren die Parteien die Zuständigkeit der ordentlichen Gerichte am Sitz des Lieferanten. Der Lieferant ist jedoch berechtigt, den Auftraggeber/Käufer/Besteller an dessen Sitz zu belangen.

(Version 09/2021)

Conditions générales continuation

10. Confidentialité

Sans convention contraire explicite par écrit, les informations qui nous sont transmises en rapport avec une commande ne sont pas considérées confidentielles. Les données auxquelles nous avons accès dans le contexte de la conclusion du contrat sont enregistrées dans le sens de la loi sur la protection de données en vigueur.

11. Produits chimiques

Nos produits chimiques tels que lubrifiants ou produits d'étanchéité ne peuvent être utilisés par le mandant/l'acheteur/le client que pour un usage professionnel. Ils ne sont pas destinés à l'usage privé et doivent être conservés hors de portée des enfants/adolescents.

12. Protection des données

L'entreprise a le droit de traiter et d'utiliser les données enregistrées dans le cadre de la conclusion du contrat afin d'assurer l'exécution des obligations du contrat. L'entreprise prend les mesures nécessaires à la protection des données conformément aux dispositions légales. Le client déclare donner son accord pour que l'entreprise enregistre et exploite ses données en conformité avec le contrat et reconnaît que l'entreprise est autorisée et obligée, sur demande des tribunaux ou des autorités, de transmettre les informations du client à ces derniers ou à des tiers. Si le client ne l'a pas expressément interdit, l'entreprise est autorisée à utiliser les données à des fins commerciales et également à les transmettre à ses partenaires à des fins publicitaires. Les données nécessaires à l'exécution de la prestation peuvent également être transmises à des partenaires de service mandatés ou à d'autres tiers. En outre, la déclaration de confidentialité est applicable. La déclaration de confidentialité est disponible sur le site web du SERTO et EXMAR.

13. Effet partiel

Si certaines clauses du contrat sont sans effet légal, le contrat garde, dans sa globalité, sa validité pour les deux parties.

Si, par ailleurs, certaines conditions précitées s'avèrent sans effet ou inapplicables, les autres conditions conservent leur validité. Une clause sans effet doit être remplacée par une autre, correspondante, en fonction du droit en vigueur.

14. Droit applicable / for juridique

Le lieu d'exécution est le lieu de fabrication. Les parties contractantes conviennent de l'application du droit matériel au siège du fournisseur. L'application de la Convention sur la loi applicable aux contrats de vente internationale de marchandises (CISG) est expressément exclue. Pour les éventuels litiges résultant du présent contrat, les parties conviennent de désigner les tribunaux ordinaires situés au siège du fournisseur. Le fournisseur a toutefois le droit de faire appel aux tribunaux ordinaires situés au siège ou au domicile du mandant.

(Version 09/2021)

Terms and Conditions continuation

is obliged and entitled to disclose information from the customer to these or third parties at the order of courts or authorities. If the customer has not expressly forbidden it, the company may use the data for marketing purposes as well as pass it on to its partners for advertising purposes. The data necessary for performance may also be passed on to commissioned service partners or other third parties. Furthermore, the Data Protection Declaration applies. The Data Protection Declaration can be found on the SERTO and EXMAR websites.

13. Partial invalidity

The legal invalidity of individual points shall not affect the validity of the remainder of the contract for both parties. Also should any of the mentioned provisions be invalid or not applicable for any other reason, the rest of the provisions shall remain valid. An invalid provision shall be replaced by a corresponding regulation of non-mandatory law.

14. Applicable law / Place of jurisdiction

The place of performance shall be the location of the supplying plant. The parties to the contract agree to apply the substantive law at the domicile of the Supplier. The applicability of the UN Convention on Contracts for the International Sales of Goods (WKR/CISG) is expressly excluded. For any possible disputes arising from this contract the parties agree to the jurisdiction of the ordinary courts at the domicile of the Supplier. The Supplier is however entitled to take legal action against the customer/purchaser/orderer at his place of business.

(Version 09/2021)

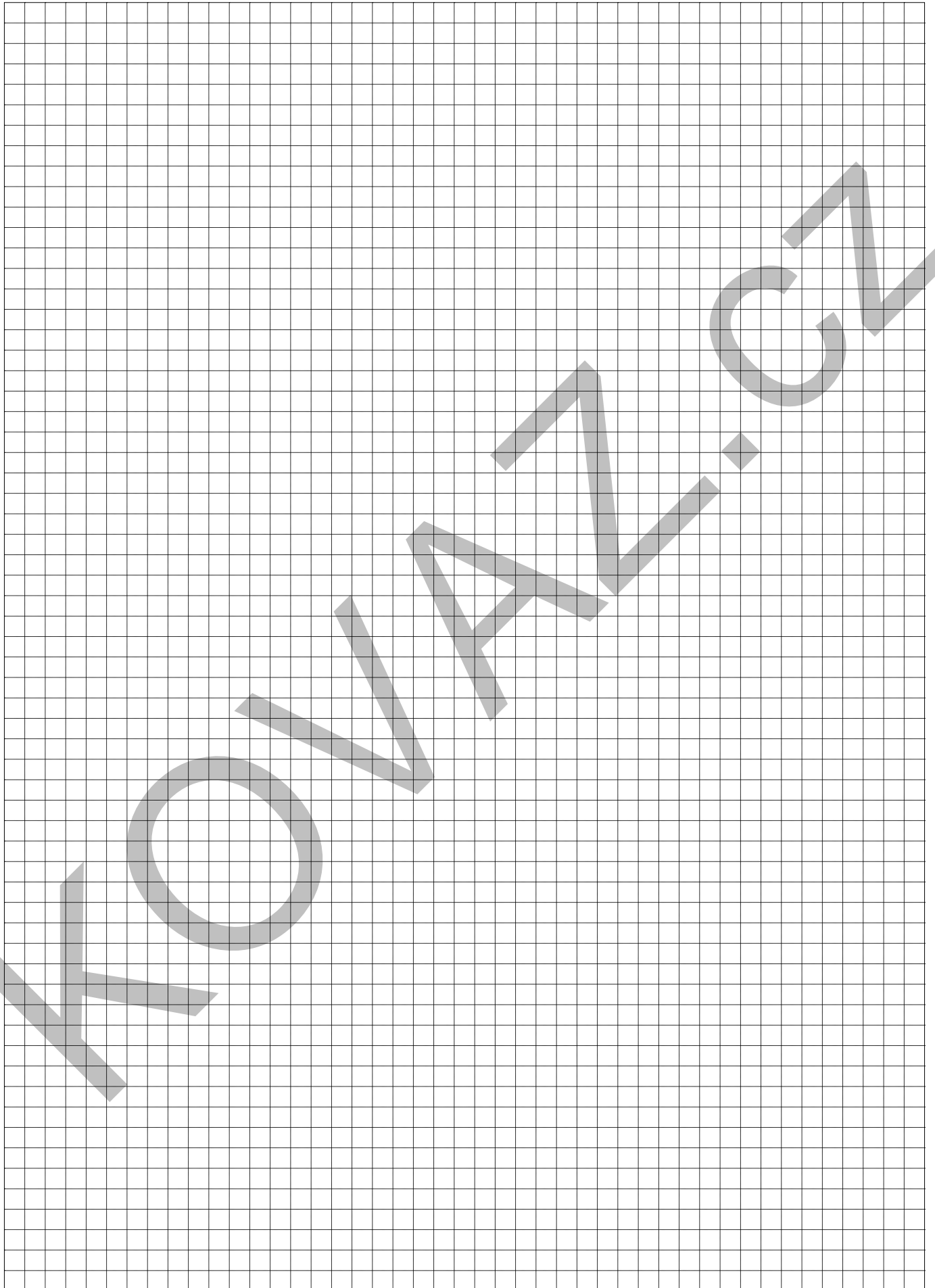

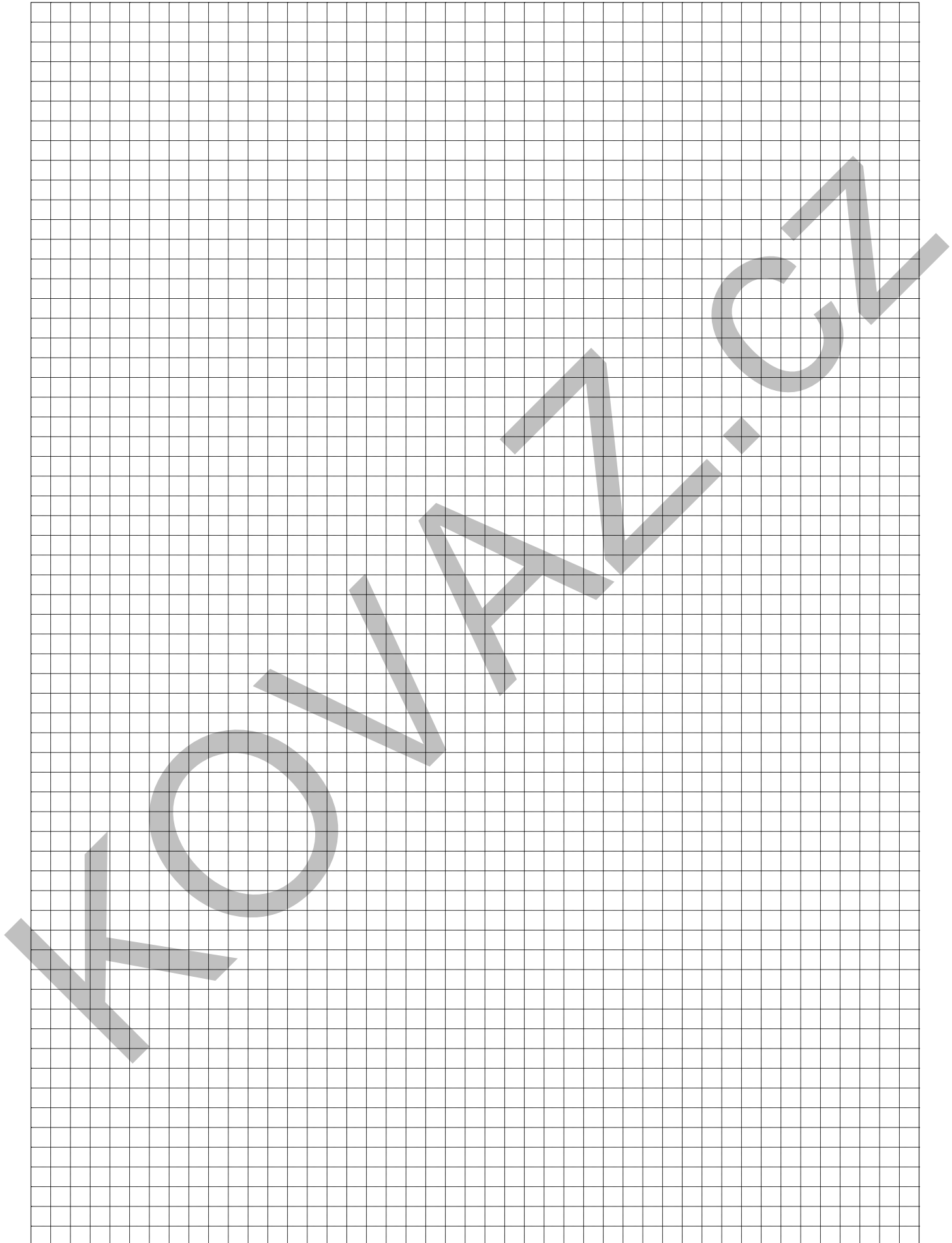

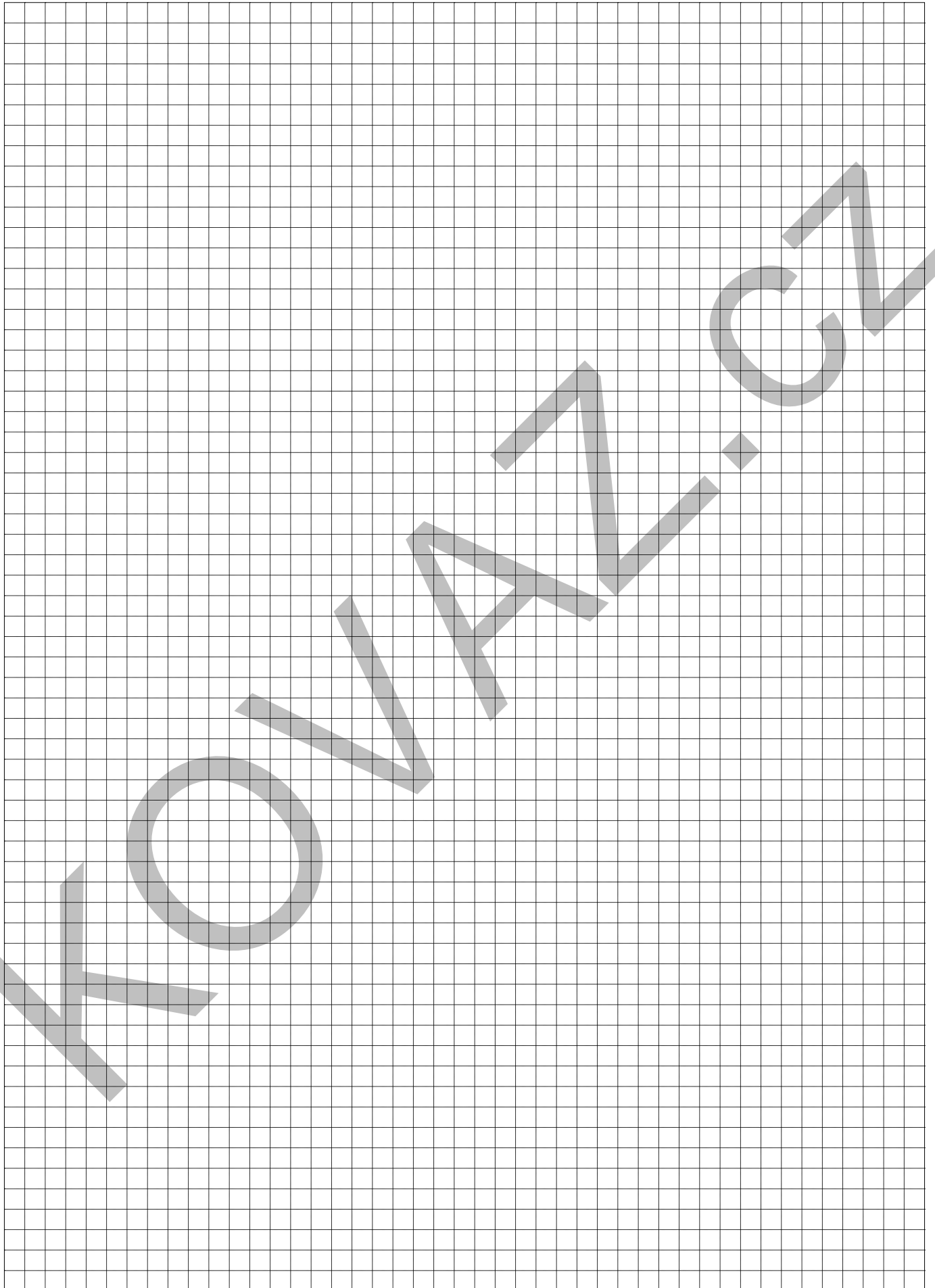

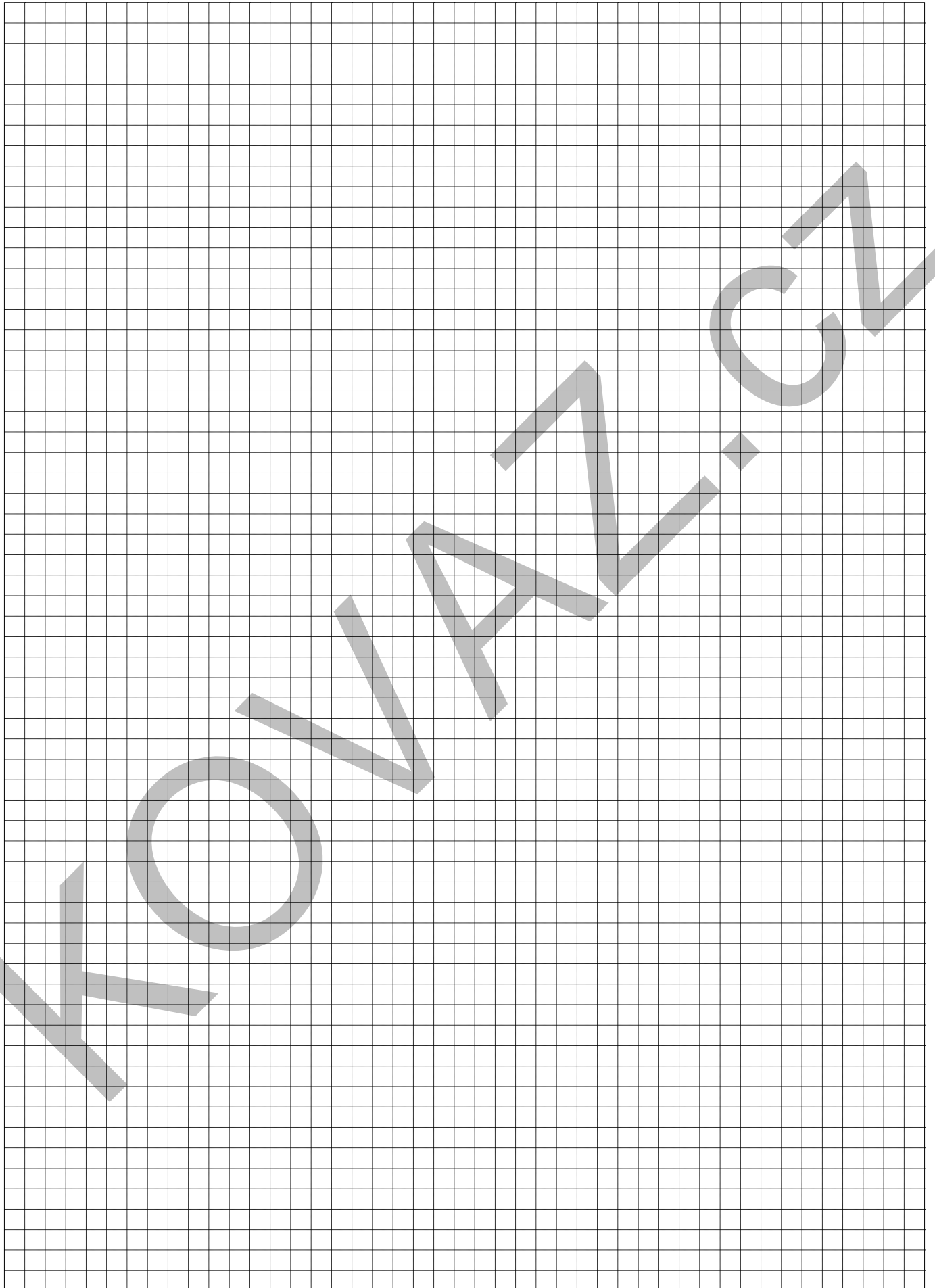

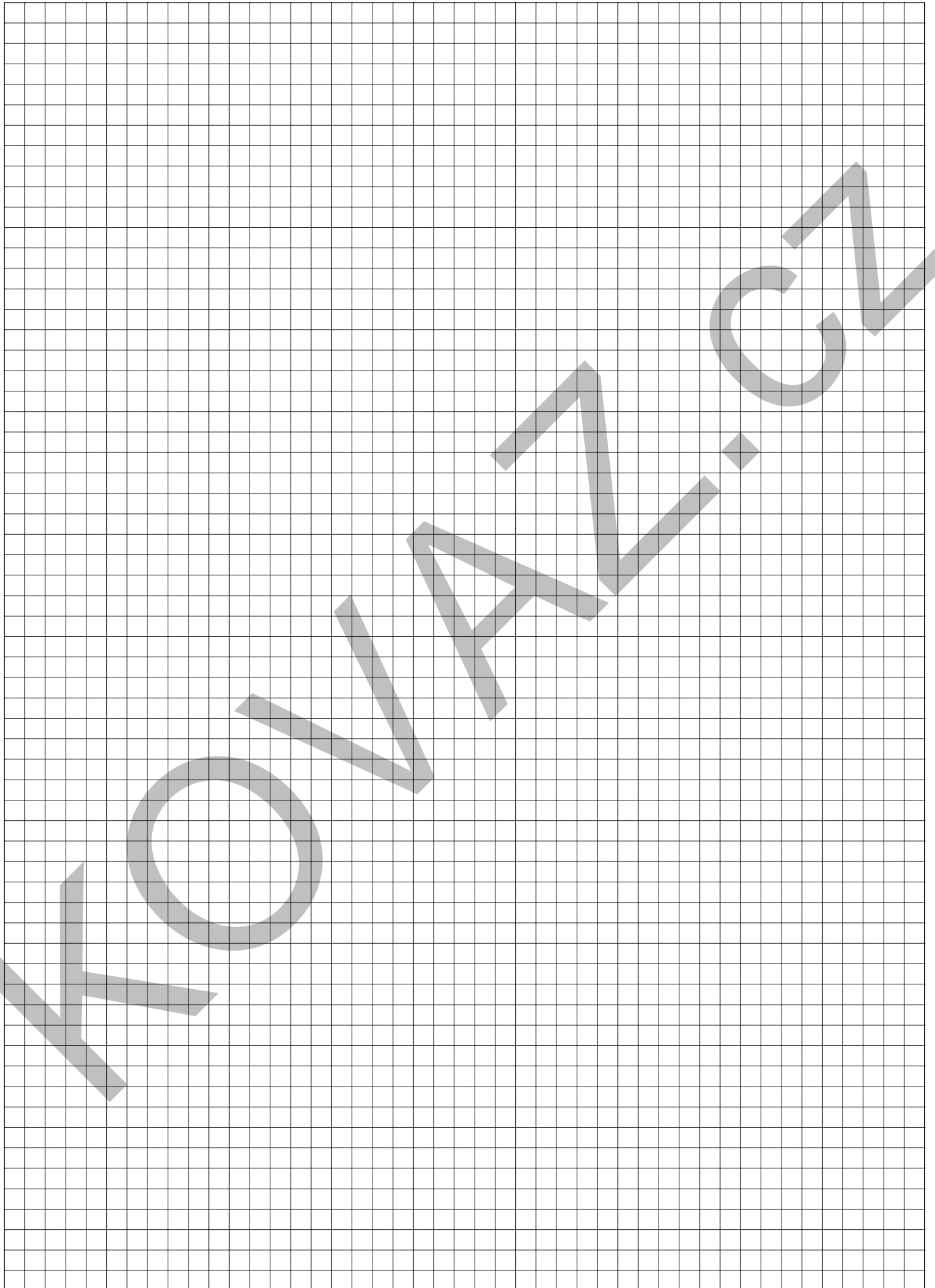

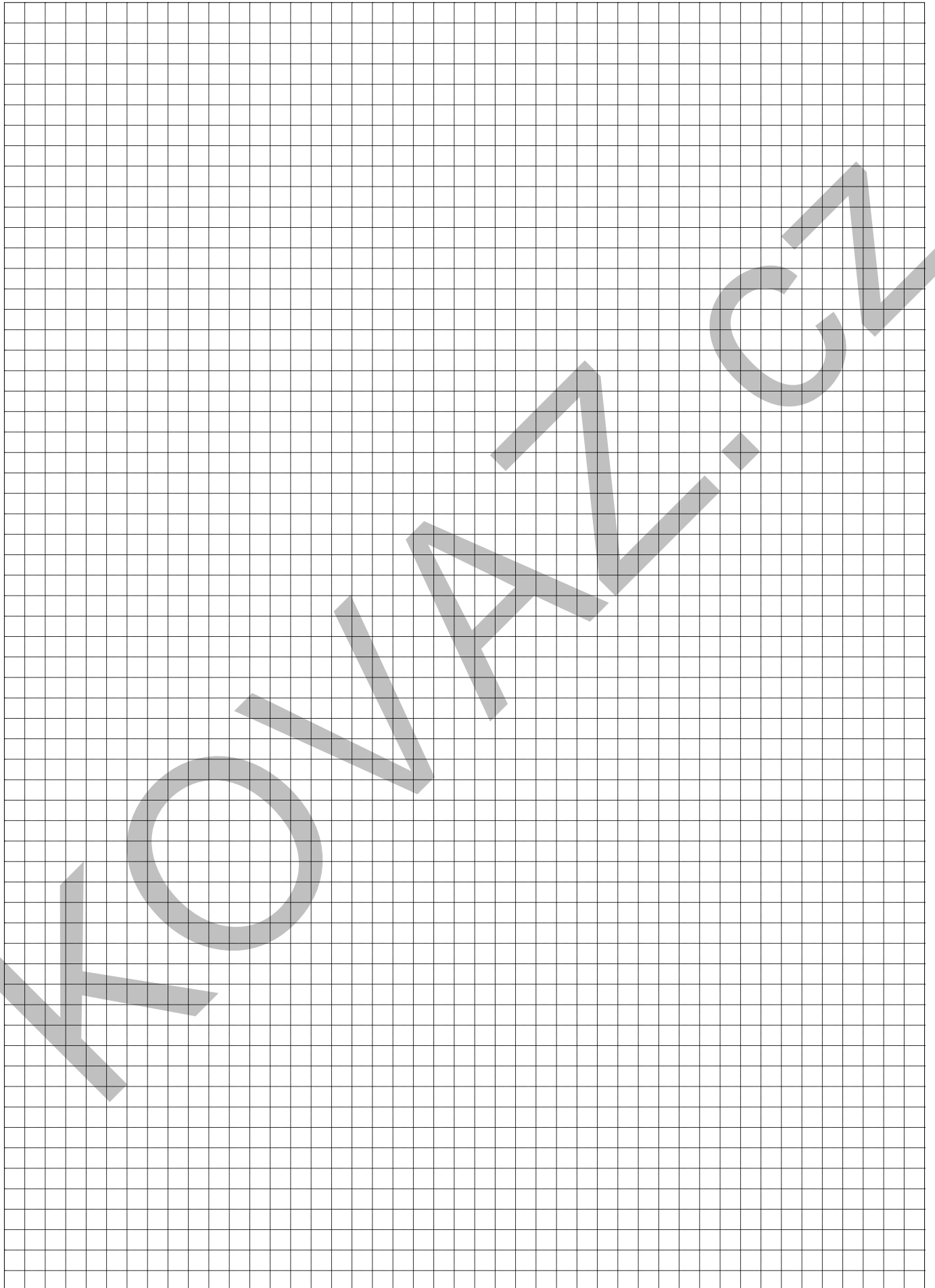

KONVANSION

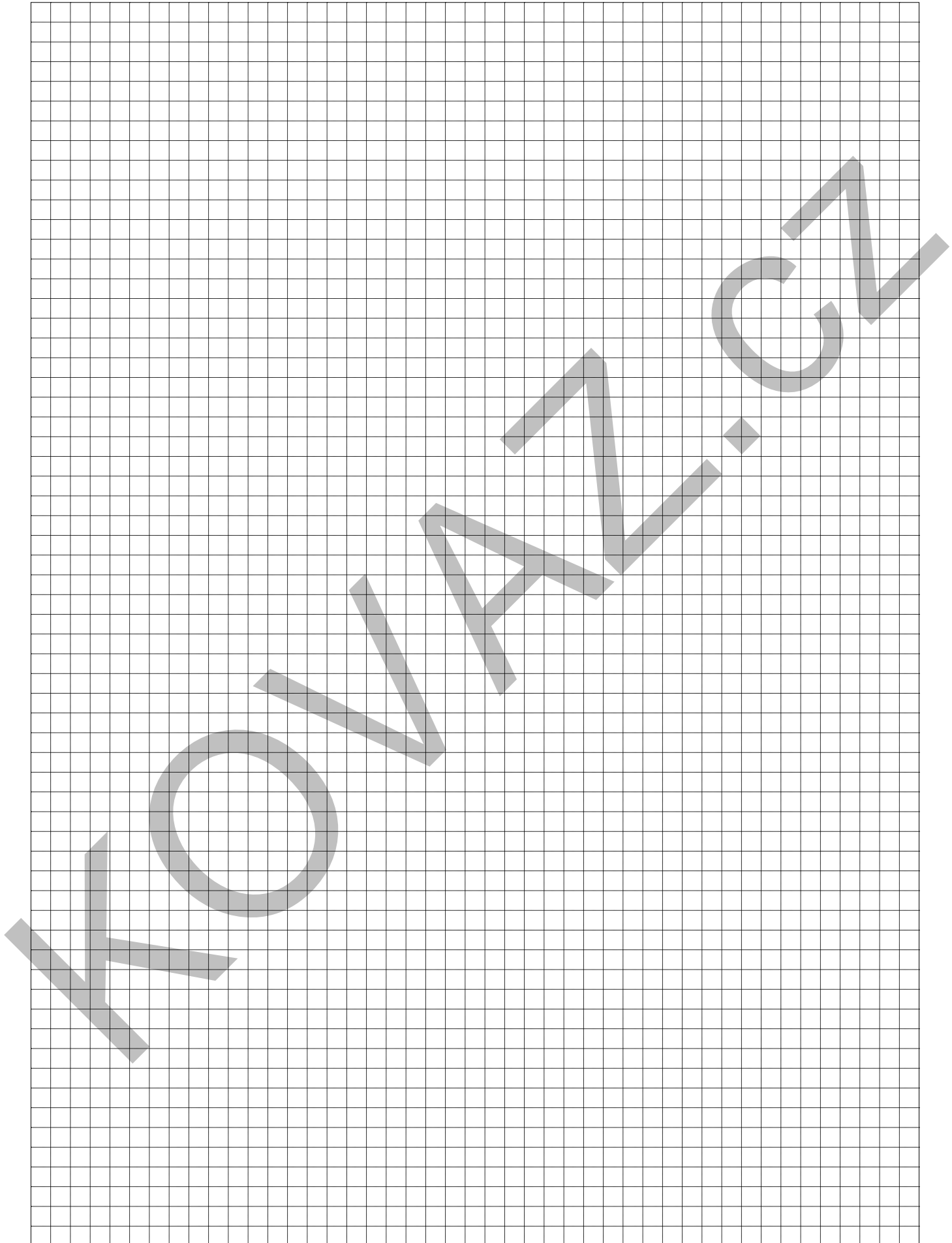

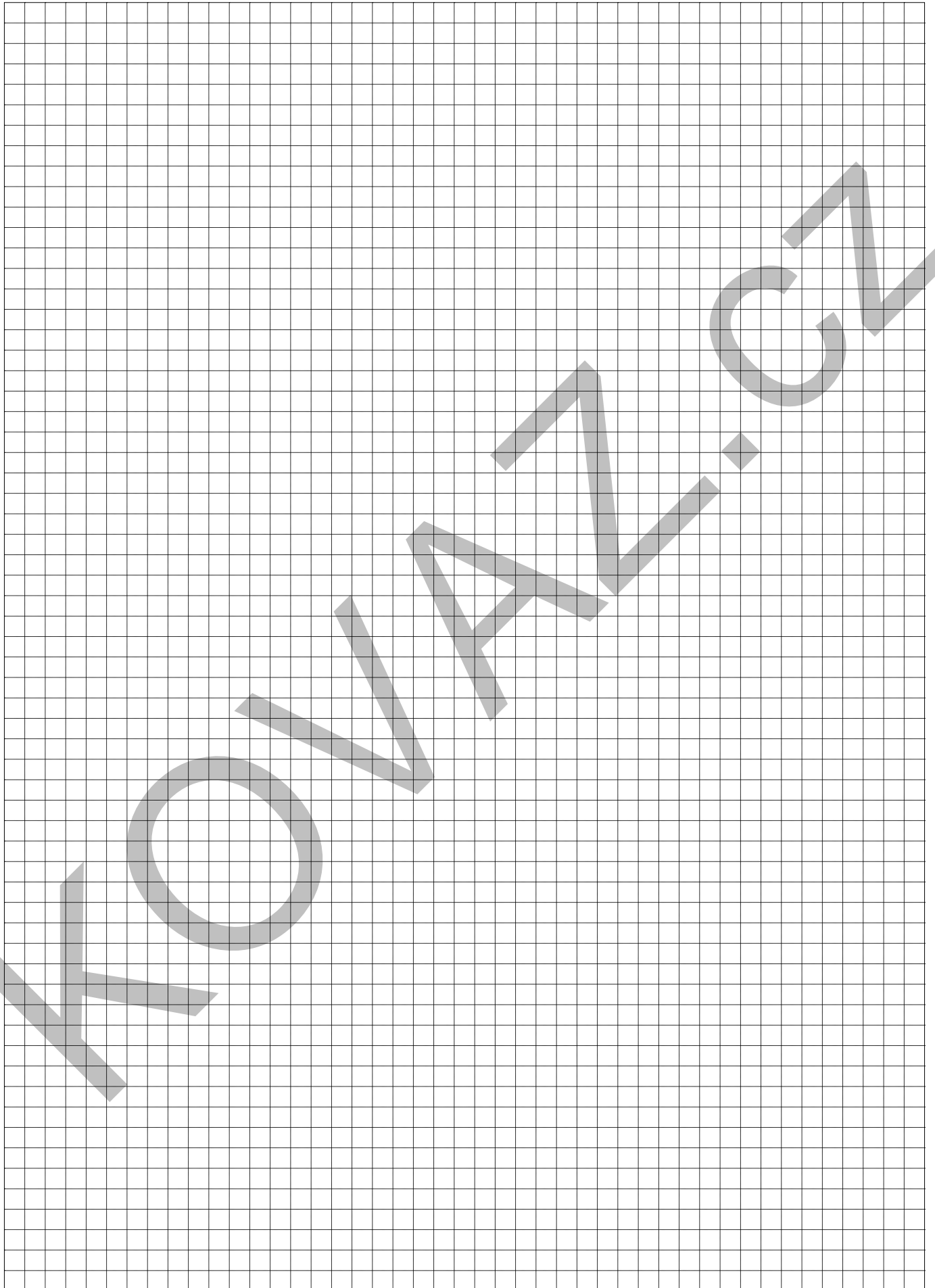

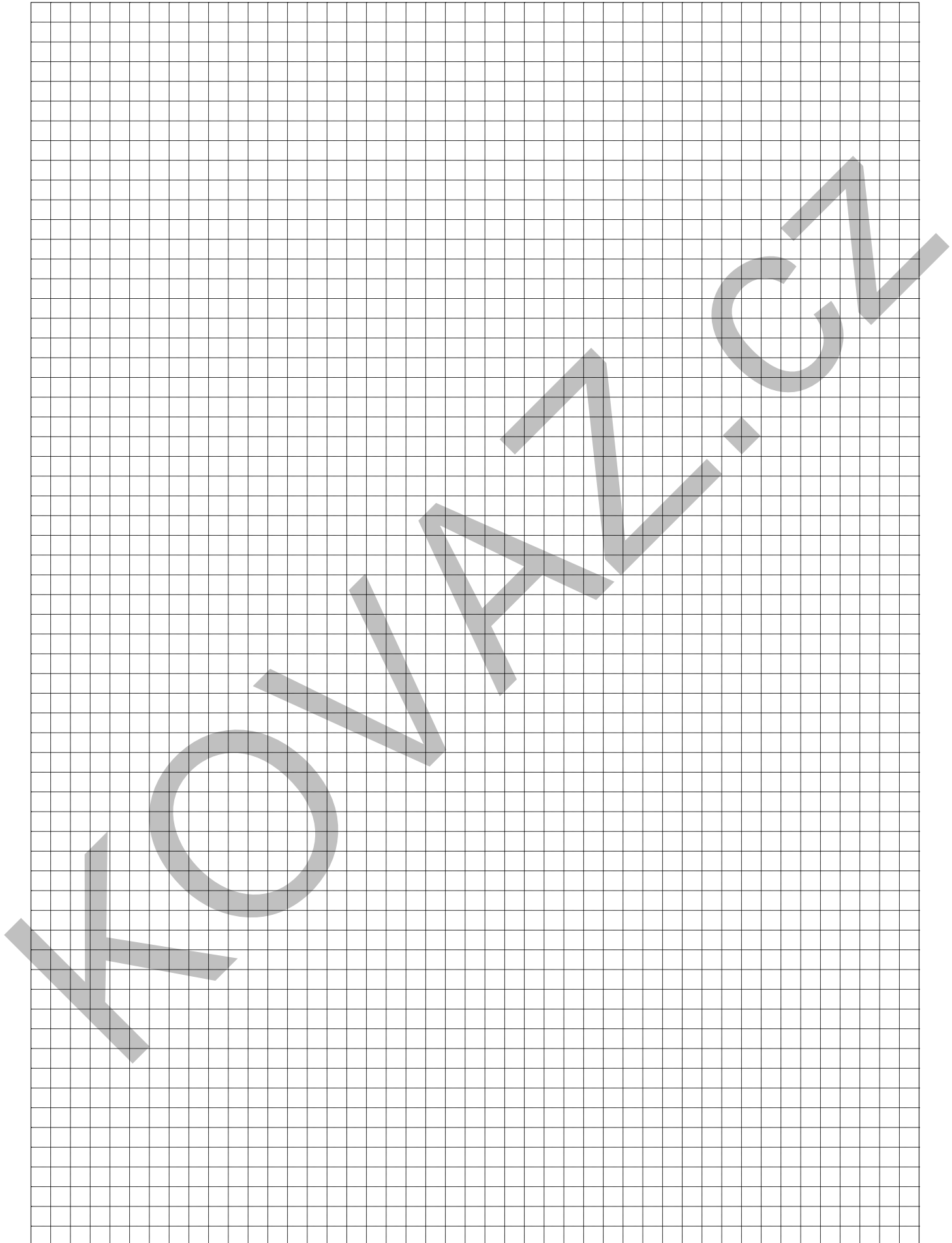

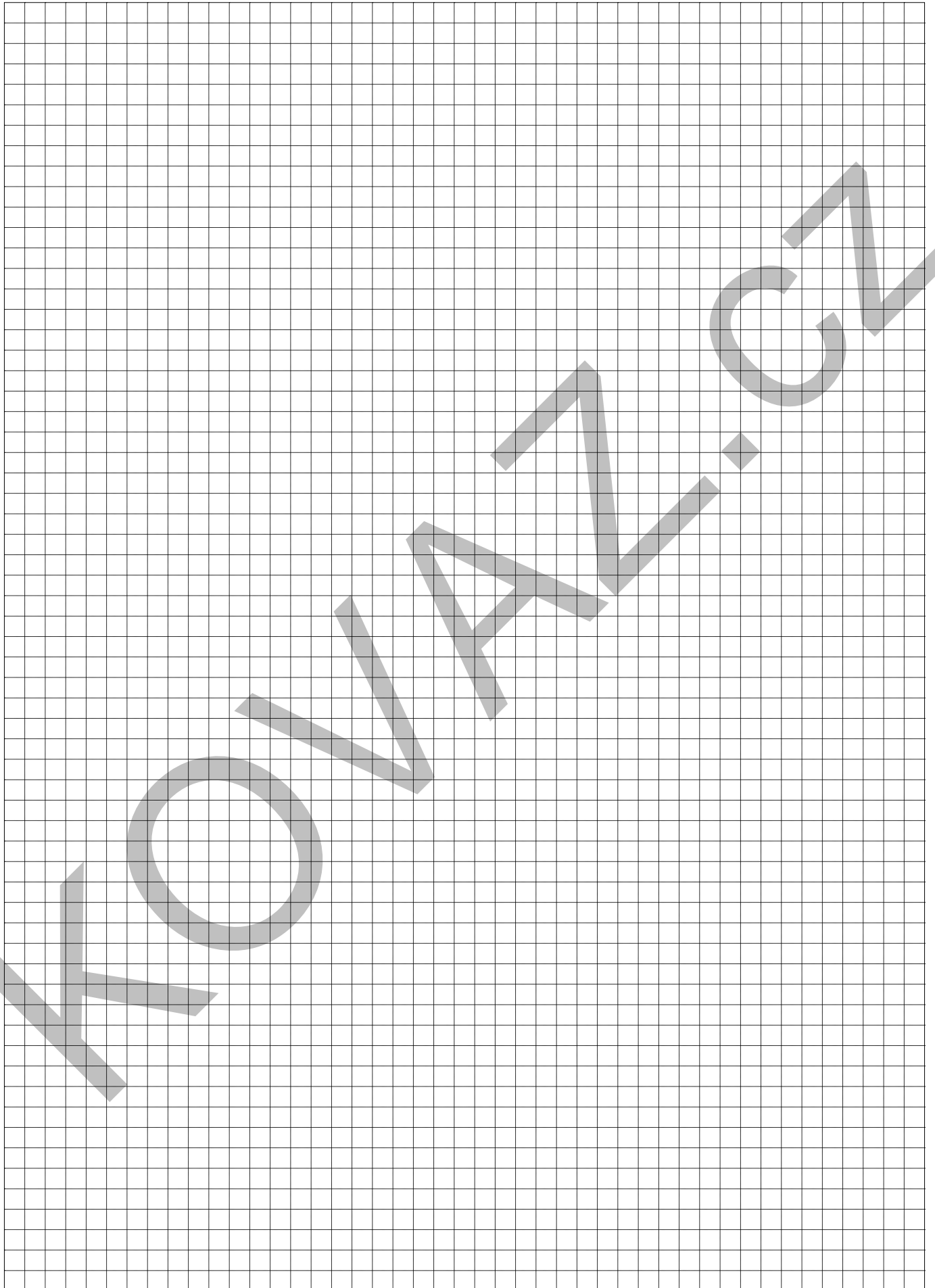

KONVANTON

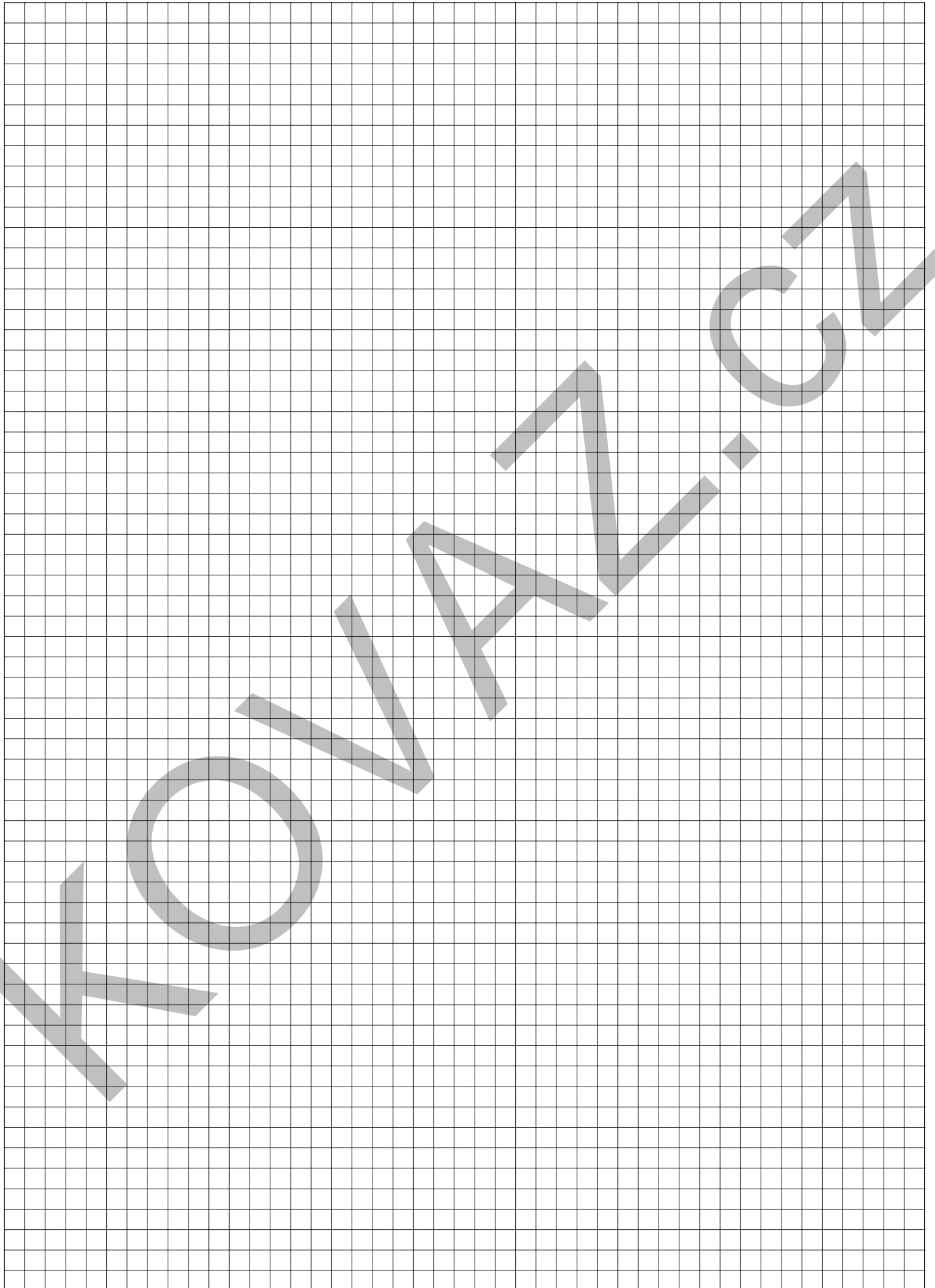

Zertifizierungen und Zulassungen
Certifications et Autorisations
Certifications and Approvals

	Beschreibung Description Description	Materialien Matériau Material	Anwendungen Applications Applications
	Zertifizierung ISO 9001 Certification ISO 9001 Certification ISO 9001	gesamte SERTO Group toute SERTO Group complete SERTO Group	-
	Zertifizierung ISO 14001 Certification ISO 14001 Certification ISO 14001	gesamte SERTO Group toute SERTO Group complete SERTO Group	-
	Zulassung SVGW Autorisation SVGW Approval SVGW	Messing M und G, Edelstahl Laiton M et G, Acier inoxydable Brass M and G, Stainless steel	Gas Gaz Gaz
	Zulassung DVGW Autorisation DVGW Approval DVGW	Messing M und G, Edelstahl Laiton M et G, Acier inoxydable Brass M and G, Stainless steel	Gas Gaz Gaz
	Zulassung ABS Autorisation ABS Approval ABS	Edelstahl Acier inoxydable Stainless steel	Schiffe (Gas, Öl, Flüssigkeiten) Navires (gaz, huile, fluides) Ships (gaz, oil, fluids)
	Zulassung Lloyd's Register Autorisation Lloyd's Register Approval Lloyd's Register	Messing M, Edelstahl Laiton M, Acier inoxydable Brass M, Stainless steel	Schiffe (Gas, Öl, Flüssigkeiten) Navires (gaz, huile, fluides) Ships (gaz, oil, fluids)
	Zulassung DNV GL Autorisation DNV GL Approval DNV GL	Edelstahl Acier inoxydable Stainless steel	Schiffe (Gas, Öl, Flüssigkeiten) Navires (gaz, huile, fluides) Ships (gaz, oil, fluids)