

Multiclamp

Pipe Clamp System



A 'fit for purpose' pipe clamping system

Leak free, noise free and vibration free pipe clamping

Multiclamp is a system of components, each one engineered to a high standard – that together build to provide effective, all-purpose pipe work clamping. Available as single clamp, double clamp, 12 or 16 hole Multiclamp, there is a complete range of split bushes to accept pipe or hose diameters from 6mm up to 50mm from 3 x Series of Multiclamp.

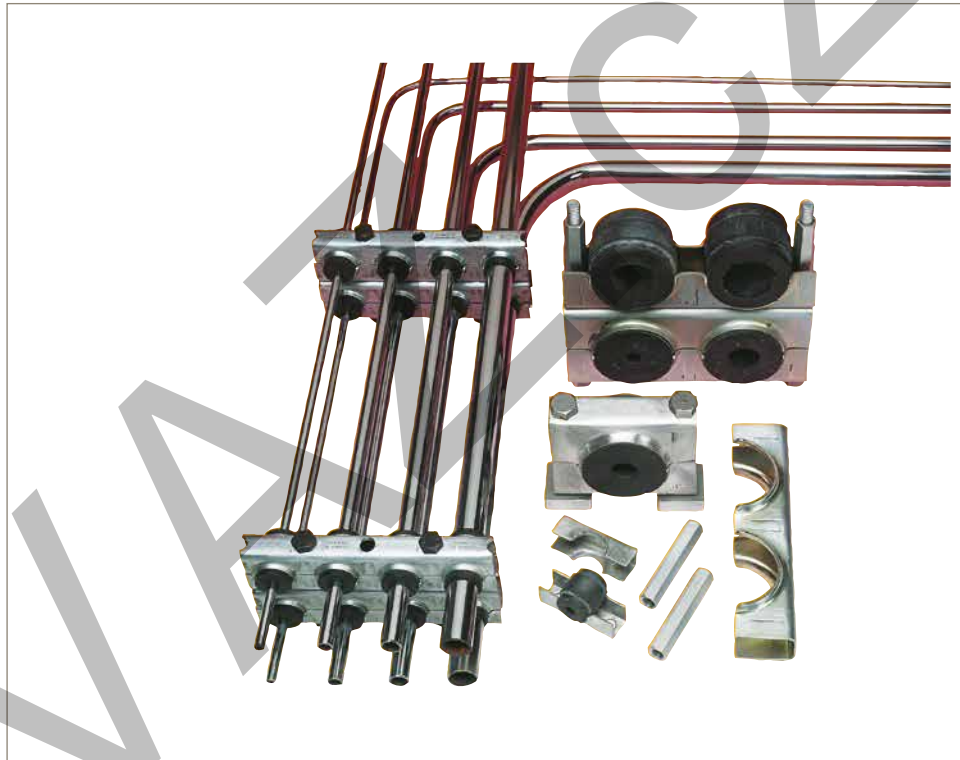

Contact Information:

Parker Hannifin
Hydraulic Filter Division Europe

European Product
Information Centre
Freephone: 00800 27 27 5374
(from AT, BE, CH, CZ, DE, EE, ES,
FI, FR, IE, IT, PT, SE, SK, UK)
filtrationinfo@parker.com

www.parker.com/hfde

Product Features:

- High quality pipe clamping system in 3 ranges - Series 10, 16 or 32.
- Pipe or hose diameters from 6mm up to 50mm.
- 26 different diameter, high quality split rubber bushes.
- Zinc plated steel construction with anti-corrosive, full passivate.
- Stainless Steel clamp available.



When only the best Clamping System will dospecify Multiclamp

Multiclamp is a system. A system of components, each one engineered to a high standard – that together build to provide effective, all-purpose pipework clamping. Multiclamp offers creative and cost-effective environmental benefits to the system designer and installer. Creating accurate runs of varying diameter tubes, pipes, hoses and cables in all industries.

Secure Multiclamp installations ensure a leak free, noise free and vibration free system.

The neat design of pipe line runs offers easy maintenance of machinery and plant equipment. Visual planning of line runs is straightforward with Multiclamp – accurate installations can be achieved without skilled labour – keeping costs down and quality up.

Planning with Multiclamp

These notes have been compiled to assist in planning your Multiclamp system.

Multiclamp offers considerable flexibility. For example, it can fit in with a factory installation that is being built in phases.

Should a last minute change in pipe diameter occur during installation, an alternative rubber bush is likely to be all that is required. Not a complete and expensive re-think of the installation.

Multiclamp metal components can be sprayed to match a vehicle livery or plant installation and, if installed properly, should require no maintenance.

Installation is simple and requires no experience

Anyone can use Multiclamp and only the basic, everyday tools are required.

From one pipe to almost any number – because each Multiclamp ‘position’ can be visually sighted and its position adjusted – an almost guaranteed straight run can be obtained. Equally, changes of plane or direction can be achieved simply and securely.

Group pipe sizes together to obtain the most economical use of three basic Multiclamp Series.

Some sites will require all pipes mounted in one single plane – either vertical or horizontal.

When stacked modules are preferred, the only work to be done on the Multiclamp is to saw off the desired length.

If a large number of pipe lines are to be run, it is recommended that the upper clamping unit is simply cut into two lines only, and progressively assembled by securing two pipes at a time. It will be recognised that most odd lengths on site will be used, and one man can easily cope with a large number of pipe lines by this simple progressive build up. This assembly will provide easy access for servicing and replacing pipes. This method also reduces the quantity of Stacking Nuts and Studs by 50%.

If a factory installation is being built in phases, it would be wise to leave the first phase with a lower clamping unit and Stacking Nuts in position ready to receive pipe runs for the next building phase.



Series 10
6.0mm-20.0mm
(1/4"-3/4")

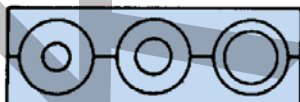

Series 16
6.0mm-28.0mm
(1/4"-1")

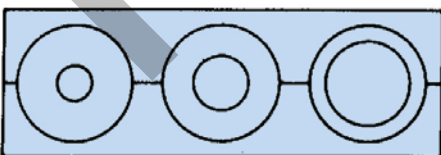

Series 32
10.0mm-50.0mm
(3/8"-2")

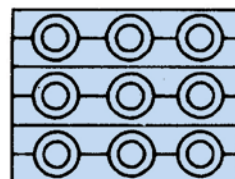

Stacked modules or single module

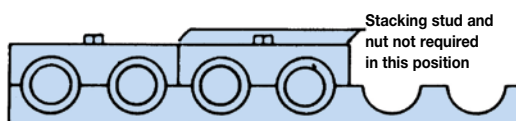
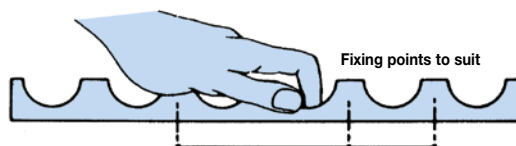

Your maximum pipe size will determine the series to use. There is a degree of versatility provided by the rubber bushes. You choose from single or multistacked Multiclamp, whichever suits your particular installation requirements.



Multiclamp

Pipe Clamp System

Specification

Dimension details supplied in product configurator

Single Clamp

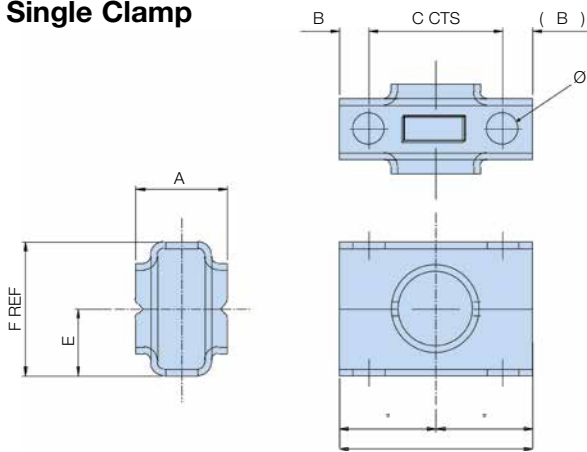

Double Clamp

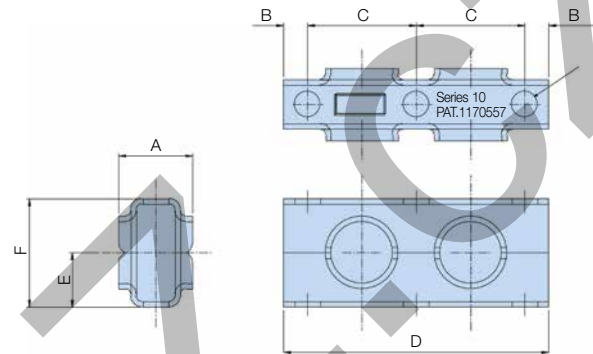

Multiclamp – 12 or 16 holes

1 box of clamping units = 1 pair

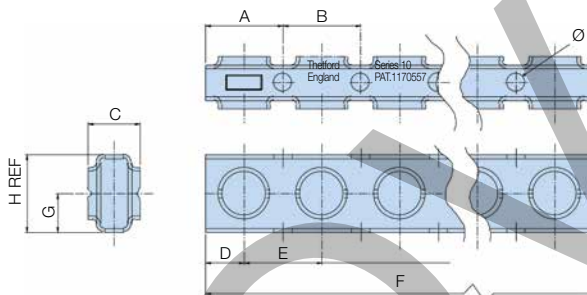

Split Bushes

Split bushes are ordered in sets only
i.e. 1 box of bushes = 10 bushes of one size

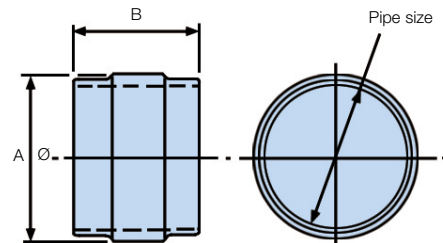

Material Specifications

Zinc plated steel with anti-corrosive, full passivate. Multiclamp can also be multi-stacked using stacking studs and nuts. Series 10 and 16 clamp is supplied in lengths of 603mm and Series 32 in lengths of 1206mm. These can be simply cut to the required lengths for installation.

Note 1: For stainless steel version please consult Parker.
Note 2: Where appropriate a 'set' has been redefined as a 'box'.

Series 10 will accept pipe or hose diameters from 6mm up to 20mm maximum. Series 16 from 6mm up to 28mm and Series 32 from 10mm up to 50mm. Across the 3 Series, there are 26 different high-quality split rubber bushes to select from to cope with any combination and number of different pipe and hose diameters in the same run.

Stacking Nuts

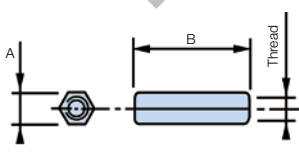

Stacking nuts are ordered in multiples of 50 stacking nuts of one size only.

Stacking Studs

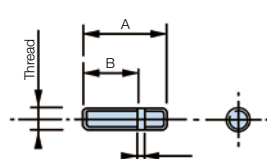

Stacking studs are ordered in multiples of 50 stacking studs of one size only.

Mounting Adaptors

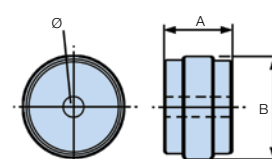

Mounting adaptors are not ordered in multiples. i.e. 1 off mounting adaptors = 1 single piece.

Weld Plate

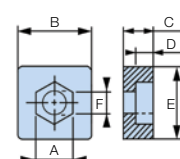

Weld plates are ordered in multiples of 10 weld plates only.



Ordering Information - Series 10

Product configurator

Part number	Supersedes	Description	Pack quantity	Dimensions (mm)								Thread	Pack weight	
				A	B	C	D	E	F	G	H			Ø
MC101	MC.10.1	Single clamp	10 pairs	25.0	8.5	38.1	55.0	19.0	38.0				9.0	0.60 Kg
MC102	MC.10.2	Double clamp	10 pairs	25.0	8.5	38.1	93.0	19.0	38.0				9.0	1.00 Kg
MC1016	MC.10.16	16 bay clamp	1 pair	34.0	38.1	25.0	15.0	38.1	601.5	19.0	38.0	9.0		1.60 Kg
MCN10	MC.N.10	Stacking nut	50	11.0	33.0								M8 x 1,25	0.80 Kg
MCS10	MC.S.10	Stacking stud	50	32.0	21.0	2.6							M8 x 1,25	0.50 Kg
MCWP10	MC.WP.10	Weld plate	10	13.3	25.0	10.0	6.3	25.0	8.5					0.35 Kg
MCSB10	MC.SB.10	Standard bolt	50	27.0									M8 x 1,25	0.55 Kg
MCB10MO	MC.B.10.MO	Mounting adaptor	1		25.0								8.7	0.02 Kg

Part number	Supersedes	Description	Pack quantity	Dimensions (mm)		Pipe size		Pack weight
				A	B	(mm)	OD	
MCG105	MC.G.10.5	Split bush	10	25.5	27.0	8	5/16	0.13 Kg
MCG106	MC.G.10.6	Split bush	10	25.5	27.0	10	3/8	0.12 Kg
MCG108	MC.G.10.8	Split bush	10	25.5	27.0	12-14	1/2	0.12 Kg
MCG1010	MC.G.10.10	Split bush	10	25.5	27.0	15-16	5/8	0.10 Kg
MCG1012	MC.G.10.12	Split bush	10	25.5	27.0	18-20	3/4	0.90 Kg
MCG104	MC.G.10.4	Split bush	10	25.5	27.0	6	1/4	0.13 Kg

Note 1: Part numbers featured with bold highlighted codes will ensure a 'standard' product selection.

Note 2: Alternate displayed part number selection will require you to contact Parker Filtration for availability.

Ordering Information - Series 16

Product configurator

Part number	Supersedes	Description	Pack quantity	Dimensions (mm)								Thread	Pack weight	
				A	B	C	D	E	F	G	H			Ø
MC161	MC.16.1	Single clamp	10 pairs	25.0	7.0	50.8	65.0	23.8	47.6				9.0	0.80 Kg
MC162	MC.16.2	Double clamp	10 pairs	25.0	7.0	50.8	116.0	23.8	47.6				9.0	1.60 Kg
MC1612	MC.16.12	12 bay clamp	1 pair	47.0	50.8	25.0	21.0	50.8	608.8	25.0	47.6	9.0		2.00 Kg
MCN16	MC.N.16	Stacking nut	50	11.0	44.0								M8 x 1,25	1.06 Kg
MCS10	MC.S.10	Stacking stud	50	32.0	21.0	2.6							M8 x 1,25	0.50 Kg
MCWP10	MC.WP.10	Weld plate	10	13.3	25.0	10.0	6.3	25.0	8.5					0.35 Kg
MCSB10	MC.SB.10	Standard bolt	50										M8 x 1,25	0.55 Kg
MCB16MO	MC.B.16.MO	Mounting adaptor	1	27.0	36.0								8.7	0.06 Kg

Part number	Supersedes	Description	Pack quantity	Dimensions (mm)		Pipe size		Pack weight
				A	B	(mm)	OD	
MCG165	MC.G.16.5	Split bush	10	35.4	27.0	8	5/16	0.28 Kg
MCG166	MC.G.16.6	Split bush	10	35.4	27.0	10	3/8	0.28 Kg
MCG168	MC.G.16.8	Split bush	10	35.4	27.0	12-14	1/2	0.26 Kg
MCG1610	MC.G.16.10	Split bush	10	35.4	27.0	15-16	5/8	0.22 Kg
MCG1612	MC.G.16.12	Split bush	10	35.4	27.0	18-20	3/4	0.20 Kg
MCG1614	MC.G.16.14	Split bush	10	35.4	27.0	22.0	7/8	0.18 Kg
MCG1616	MC.G.16.16	Split bush	10	35.4	27.0	25.0	1	0.14 Kg
MCG1618	MC.G.16.18	Split bush	10	35.4	27.0	28.0		0.16 Kg
MCG164	MC.G.16.4	Split bush	10	35.4	27.0	6	1/4	0.28 Kg

Note 1: Part numbers featured with bold highlighted codes will ensure a 'standard' product selection.

Note 2: Alternate displayed part number selection will require you to contact Parker Filtration for availability.

Multiclamp

Pipe Clamp System

Ordering Information - Series 32

Product configurator

Part number	Supersedes	Description	Pack quantity	Dimensions (mm)										Thread	Pack weight	
				A	B	C	D	E	F	G	H	Ø				
MC321	MC.32.1	Single clamp	10 pairs	40.0	9.4	76.2	95.0	38.0	76.2						11.1	2.25 Kg
MC322	MC.32.2	Double clamp	10 pairs	41.0	9.4	76.2	171.0	38.0	76.2						11.1	3.82 Kg
MC3216	MC.32.16	16 bay clamp	1 pair	72.0	76.2	40.0	34.0	76.2	1211.0	38.5	77.0	11.0				7.60 Kg
MCN32	MC.N.32	Stacking nut	50	13.0	71.5										M10 x 1.5	1.99 Kg
MCS32	MC.S.32	Stacking stud	50	38.0	22.0	4.0									M10 x 1.5	0.90 Kg
MCWP32	MC.WP.32	Weld plate	10	17.5	32.0	12.0	8.0	32.0	11.0							0.70 Kg
MCSB32	MC.SB.32	Standard bolt	50												M10 x 1.5	1.30 Kg
MCB32MO	MC.B.32.MO	Mounting adaptor	1	40.0	58.0									10.7		0.26 Kg

Part number	Supersedes	Description	Pack quantity	Dimensions (mm)		Pipe size		Pack weight
				A	B	(mm)	OD	
MCG3210	MC.G.32.10	Split bush	10	59.0	44.5	15-16	5/8	1.10 Kg
MCG3212	MC.G.32.12	Split bush	10	59.0	44.5	18-20	3/4	1.10 Kg
MCG3216	MC.G.32.16	Split bush	10	59.0	44.5	25	1	1.00 Kg
MCG3218	MC.G.32.18	Split bush	10	59.0	44.5	28-30		1.00 Kg
MCG3220	MC.G.32.20	Split bush	10	59.0	44.5	32-34	1 1/4	0.80 Kg
MCG3224	MC.G.32.24	Split bush	10	59.0	44.5	35-38	1 1/4	0.80 Kg
MCG3232	MC.G.32.32	Split bush	10	59.0	44.5	50	2	0.40 Kg
MCG326	MC.G.32.6	Split bush	10	59.0	44.5	10	3/8	1.30 Kg
MCG328	MC.G.32.8	Split bush	10	59.0	44.5	12-14	1/2	1.20 Kg
MCG3214	MC.G.32.14	Split bush	10	59.0	44.5	22	7/8	1.00 Kg
MCG3226	MC.G.32.26	Split bush	10	59.0	44.5	42		0.60 Kg

Note 1: Part numbers featured with bold highlighted codes will ensure a 'standard' product selection.

Note 2: Alternate displayed part number selection will require you to contact Parker Filtration for availability.

How to 'build' Multiclamp

